

### General Description

MIC4421 and MIC4422 MOSFET drivers are rugged, efficient, and easy to use. The MIC4421 is an inverting driver, while the MIC4422 is a non-inverting driver.

Both versions are capable of 9A (peak) output and can drive the largest MOSFETs with an improved safe operating margin. The MIC4421/4422 accepts any logic input from 2.4V to  $V_s$  without external speed-up capacitors or resistor networks. Proprietary circuits allow the input to swing negative by as much as 5V without damaging the part. Additional circuits protect against damage from electrostatic discharge.

MIC4421/4422 drivers can replace three or more discrete components, reducing PCB area requirements, simplifying product design, and reducing assembly cost.

Modern Bipolar/CMOS/DMOS construction guarantees freedom from latch-up. The rail-to-rail swing capability of CMOS/DMOS insures adequate gate voltage to the MOSFET during power up/down sequencing. Since these devices are fabricated on a self-aligned process, they have very low crossover current, run cool, use little power, and are easy to drive.

### Features

- BiCMOS/DMOS Construction
- Latch-Up Proof: Fully Isolated Process is Inherently Immune to Any Latch-up.
- Input Will Withstand Negative Swing of Up to 5V
- Matched Rise and Fall Times ..... 25ns
- High Peak Output Current ..... 9A Peak
- Wide Operating Range ..... 4.5V to 18V
- High Capacitive Load Drive ..... 47,000pF
- Low Delay Time ..... 30ns Typ.
- Logic High Input for Any Voltage from 2.4V to  $V_s$
- Low Equivalent Input Capacitance (typ) ..... 7pF
- Low Supply Current ..... 450 $\mu$ A With Logic 1 Input
- Low Output Impedance ..... 1.5 $\Omega$
- Output Voltage Swing to Within 25mV of GND or  $V_s$

### Applications

- Switch Mode Power Supplies
- Motor Controls
- Pulse Transformer Driver
- Class-D Switching Amplifiers
- Line Drivers
- Driving MOSFET or IGBT Parallel Chip Modules
- Local Power ON/OFF Switch
- Pulse Generators

### Functional Diagram



## Ordering Information

Part Number		Configuration	Temp. Range	Package
Standard	PbFree			
MIC4421BM	MIC4421YM	Inverting	-40°C to +85°C	8-pin SOIC
MIC4421BN	MIC4421YN	Inverting	-40°C to +85°C	8-pin DIP
MIC4421CM	MIC4421ZM	Inverting	-0°C to +70°C	8-pin SOIC
MIC4421CN	MIC4421ZN	Inverting	-0°C to +70°C	8-pin DIP
MIC4421CT	MIC4421ZT	Inverting	-0°C to +70°C	5-pin TO-220
MIC4422BM	MIC4422YM	Non-inverting	-40°C to +85°C	8-pin SOIC
MIC4422BN	MIC4422YN	Non-inverting	-40°C to +85°C	8-pin DIP
MIC4422CM	MIC4422ZM	Non-inverting	-0°C to +70°C	8-pin SOIC
MIC4422CN	MIC4422ZN	Non-inverting	-0°C to +70°C	8-pin DIP
MIC4422CT	MIC4422ZT	Non-inverting	-0°C to +70°C	5-pin TO-220

## Pin Configurations

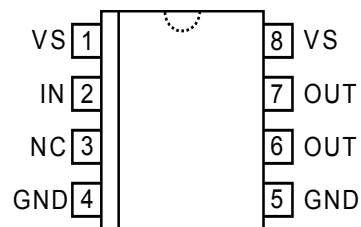

Plastic DIP (N)  
SOIC (M)

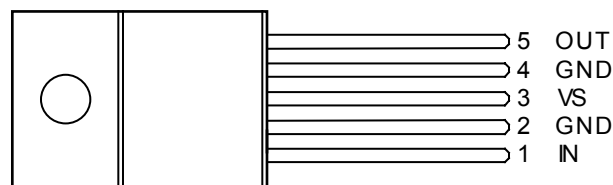

TO-220-5 (T)

## Pin Description

Pin Number TO-220-5	Pin Number DIP, SOIC	Pin Name	Pin Function
1	2	IN	Control Input
2, 4	4, 5	GND	Ground: Duplicate pins must be externally connected together.
3, TAB	1, 8	V <sub>s</sub>	Supply Input: Duplicate pins must be externally connected together.
5	6, 7	OUT	Output: Duplicate pins must be externally connected together.
	3	NC	Not connected.

**Absolute Maximum Ratings** (Notes 1, 2 and 3)

Supply Voltage .....	20V
Input Voltage .....	$V_S + 0.3V$ to $GND - 5V$
Input Current ( $V_{IN} > V_S$ ) .....	50 mA
Power Dissipation, $T_A \leq 25^\circ C$	
PDIP .....	960mW
SOIC .....	1040mW
5-Pin TO-220 .....	2W
Power Dissipation, $T_{CASE} \leq 25^\circ C$	
5-Pin TO-220 .....	12.5W
Derating Factors (to Ambient)	
PDIP .....	7.7mW/ $^\circ C$
SOIC .....	8.3mW/ $^\circ C$
5-Pin TO-220 .....	17mW/ $^\circ C$
Storage Temperature .....	$-65^\circ C$ to $+150^\circ C$
Lead Temperature (10 sec) .....	300 $^\circ C$

**Operating Ratings**

Junction Temperature .....	150 $^\circ C$
Ambient Temperature	
C Version .....	0 $^\circ C$ to +70 $^\circ C$
B Version .....	-40 $^\circ C$ to +85 $^\circ C$
Thermal Resistance	
5-Pin TO-220 ( $\theta_{JC}$ ) .....	10 $^\circ C/W$

**Electrical Characteristics:** ( $T_A = 25^\circ C$  with  $4.5 V \leq V_S \leq 18 V$  unless otherwise specified.)

Symbol	Parameter	Conditions	Min	Typ	Max	Units
<b>INPUT</b>						
$V_{IH}$	Logic 1 Input Voltage		2.4	1.3		V
$V_{IL}$	Logic 0 Input Voltage			1.1	0.8	V
$V_{IN}$	Input Voltage Range		-5		$V_S + 0.3$	V
$I_{IN}$	Input Current	$0 V \leq V_{IN} \leq V_S$	-10		10	$\mu A$
<b>OUTPUT</b>						
$V_{OH}$	High Output Voltage	See Figure 1	$V_S - 0.025$			V
$V_{OL}$	Low Output Voltage	See Figure 1			0.025	V
$R_O$	Output Resistance, Output High	$I_{OUT} = 10 \text{ mA}, V_S = 18 \text{ V}$		0.6		$\Omega$
$R_O$	Output Resistance, Output Low	$I_{OUT} = 10 \text{ mA}, V_S = 18 \text{ V}$		0.8	1.7	$\Omega$
$I_{PK}$	Peak Output Current	$V_S = 18 \text{ V}$ (See Figure 6)		9		A
$I_{DC}$	Continuous Output Current		2			A
$I_R$	Latch-Up Protection Withstand Reverse Current	Duty Cycle $\leq 2\%$ $t \leq 300 \mu s$	>1500			mA
<b>SWITCHING TIME</b> (Note 3)						
$t_R$	Rise Time	Test Figure 1, $C_L = 10,000 \text{ pF}$		20	75	ns
$t_F$	Fall Time	Test Figure 1, $C_L = 10,000 \text{ pF}$		24	75	ns
$t_{D1}$	Delay Time	Test Figure 1		15	60	ns
$t_{D2}$	Delay Time	Test Figure 1		35	60	ns
<b>POWER SUPPLY</b>						
$I_S$	Power Supply Current	$V_{IN} = 3 \text{ V}$ $V_{IN} = 0 \text{ V}$		0.4 80	1.5 150	mA $\mu A$
$V_S$	Operating Input Voltage		4.5		18	V

**Electrical Characteristics:** (Over operating temperature range with  $4.5V \leq V_S \leq 18V$  unless otherwise specified.)

Symbol	Parameter	Conditions	Min	Typ	Max	Units
<b>INPUT</b>						
$V_{IH}$	Logic 1 Input Voltage		2.4	1.4		V
$V_{IL}$	Logic 0 Input Voltage			1.0	0.8	V
$V_{IN}$	Input Voltage Range		-5		$V_S+0.3$	V
$I_{IN}$	Input Current	$0V \leq V_{IN} \leq V_S$	-10		10	$\mu A$
<b>OUTPUT</b>						
$V_{OH}$	High Output Voltage	Figure 1	$V_S-.025$			V
$V_{OL}$	Low Output Voltage	Figure 1			0.025	V
$R_O$	Output Resistance, Output High	$I_{OUT} = 10mA, V_S = 18V$		0.8	3.6	$\Omega$
$R_O$	Output Resistance, Output Low	$I_{OUT} = 10mA, V_S = 18V$		1.3	2.7	$\Omega$
<b>SWITCHING TIME (Note 3)</b>						
$t_R$	Rise Time	Figure 1, $C_L = 10,000pF$		23	120	ns
$t_F$	Fall Time	Figure 1, $C_L = 10,000pF$		30	120	ns
$t_{D1}$	Delay Time	Figure 1		20	80	ns
$t_{D2}$	Delay Time	Figure 1		40	80	ns
<b>POWER SUPPLY</b>						
$I_S$	Power Supply Current	$V_{IN} = 3V$ $V_{IN} = 0V$		0.6 0.1	3 0.2	mA
$V_S$	Operating Input Voltage		4.5		18	V

- Note 1:** Functional operation above the absolute maximum stress ratings is not implied.
- Note 2:** Static-sensitive device. Store only in conductive containers. Handling personnel and equipment should be grounded to prevent damage from static discharge.
- Note 3:** Switching times guaranteed by design.

**Test Circuits**

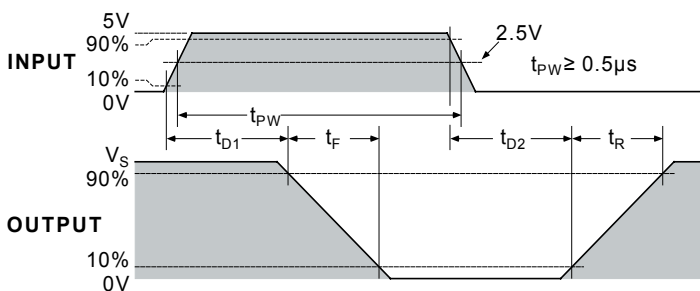
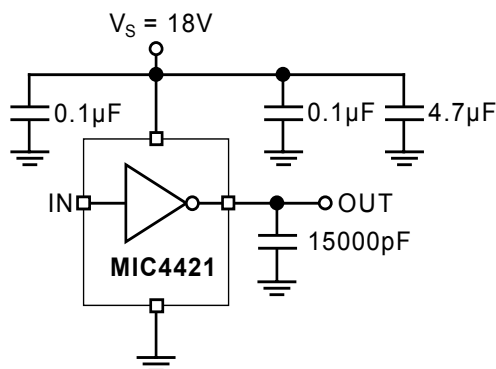

Figure 1. Inverting Driver Switching Time

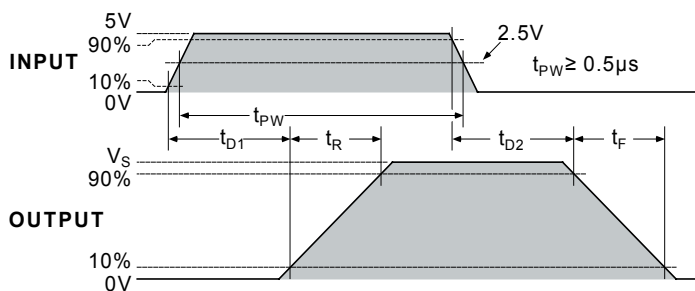
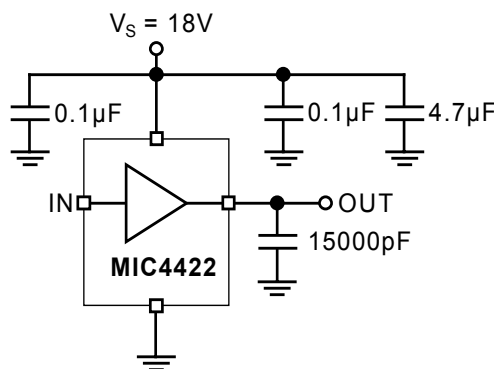
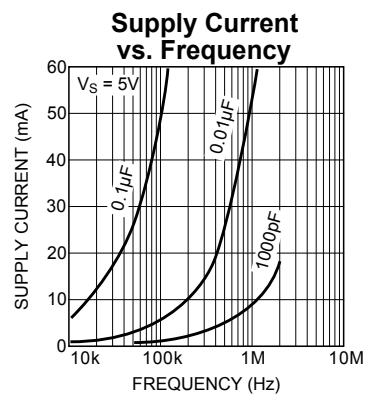
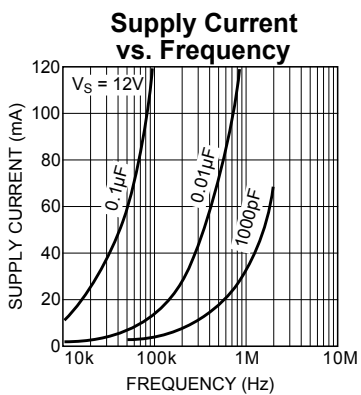
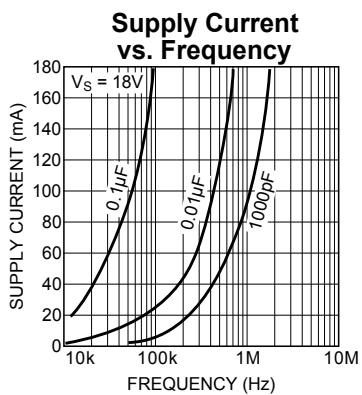
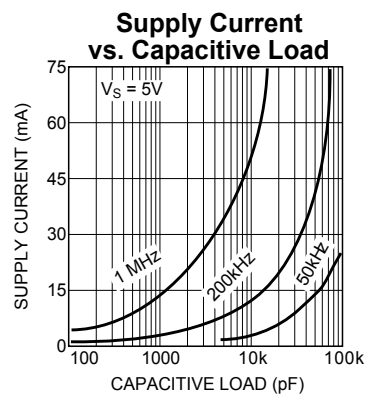
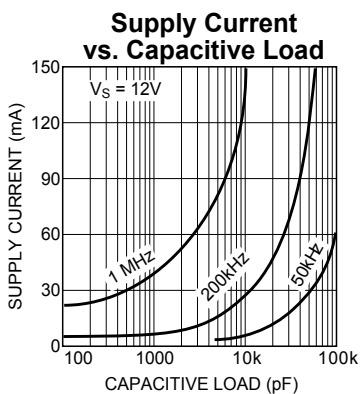
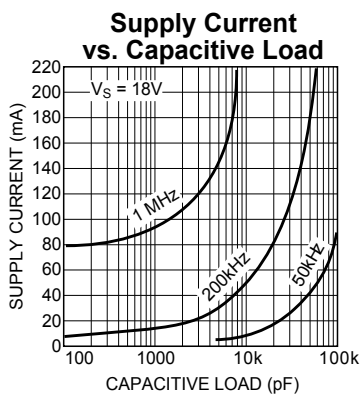
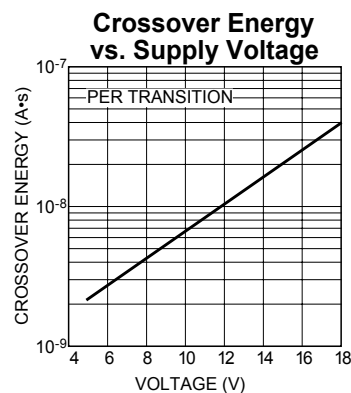
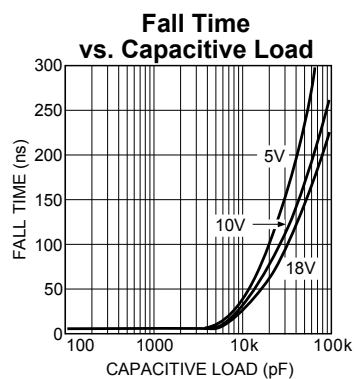
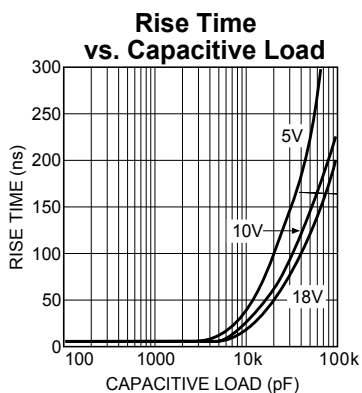
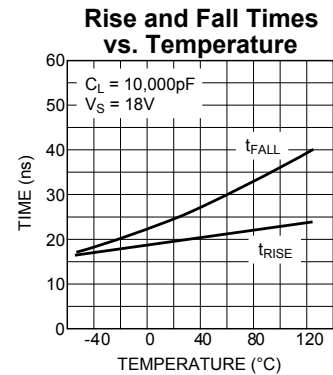
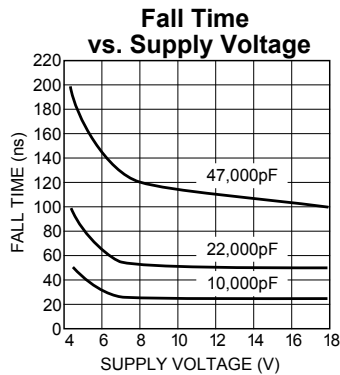
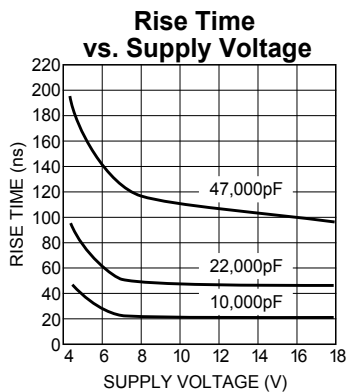
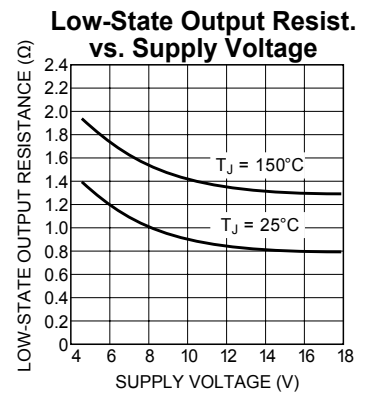
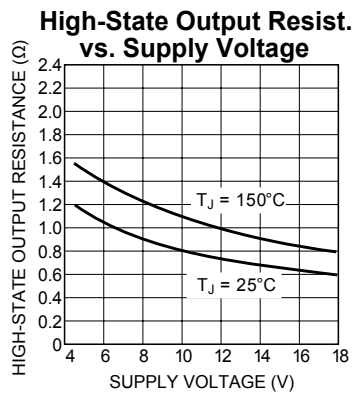
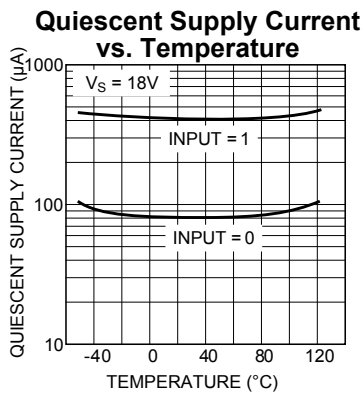
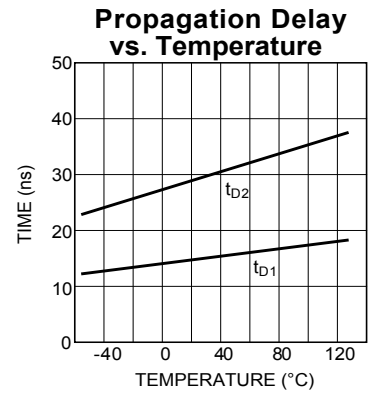
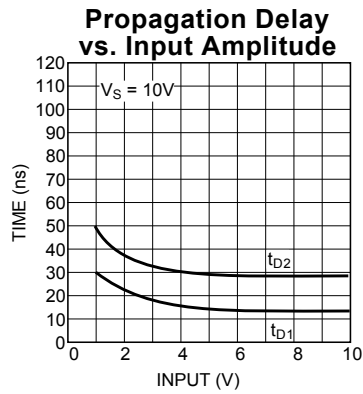
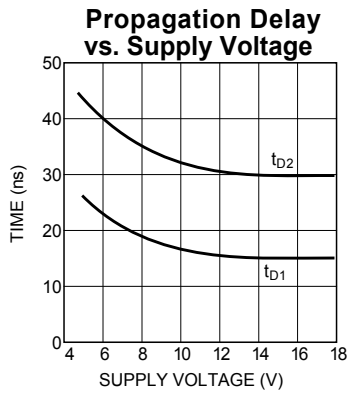

Figure 2. Noninverting Driver Switching Time

# Typical Characteristics



# Typical Characteristics



## Applications Information

### Supply Bypassing

Charging and discharging large capacitive loads quickly requires large currents. For example, charging a 10,000pF load to 18V in 50ns requires 3.6A.

The MIC4421/4422 has double bonding on the supply pins, the ground pins and output pins. This reduces parasitic lead inductance. Low inductance enables large currents to be switched rapidly. It also reduces internal ringing that can cause voltage breakdown when the driver is operated at or near the maximum rated voltage.

Internal ringing can also cause output oscillation due to feedback. This feedback is added to the input signal since it is referenced to the same ground.

To guarantee low supply impedance over a wide frequency range, a parallel capacitor combination is recommended for supply bypassing. Low inductance ceramic disk capacitors with short lead lengths (< 0.5 inch) should be used. A 1µF low ESR film capacitor in parallel with two 0.1µF low ESR ceramic capacitors, (such as AVX RAM Guard®), provides adequate bypassing. Connect one ceramic capacitor directly between pins 1 and 4. Connect the second ceramic capacitor directly between pins 8 and 5.

### Grounding

The high current capability of the MIC4421/4422 demands careful PC board layout for best performance. Since the MIC4421 is an inverting driver, any ground lead impedance will appear as negative feedback which can degrade switching speed. Feedback is especially noticeable with slow-rise time inputs. The MIC4421 input structure includes about 200mV of hysteresis to ensure clean transitions and freedom from oscillation, but attention to layout is still recommended.

Figure 5 shows the feedback effect in detail. As the MIC4421 input begins to go positive, the output goes negative and several amperes of current flow in the ground lead. As little as 0.05Ω of PC trace resistance can produce hundreds of millivolts at the MIC4421 ground pins. If the driving logic is referenced to power ground, the effective logic input level is reduced and oscillation may result.

To insure optimum performance, separate ground traces should be provided for the logic and power connections. Connecting the logic ground directly to the MIC4421 GND pins will ensure full logic drive to the input and ensure fast output switching. Both of the MIC4421 GND pins should, however, still be connected to power ground.

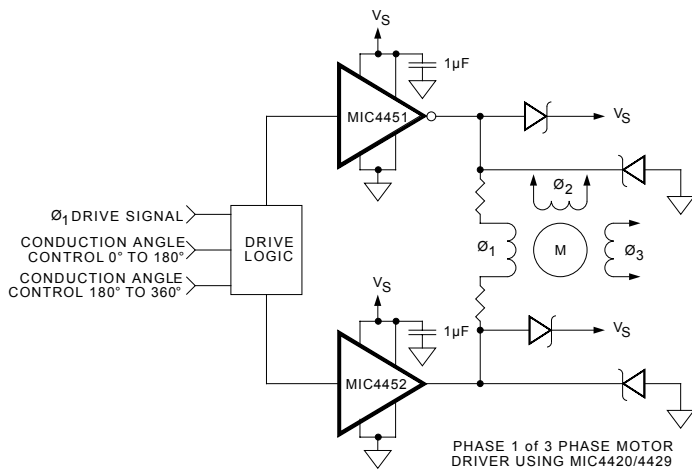
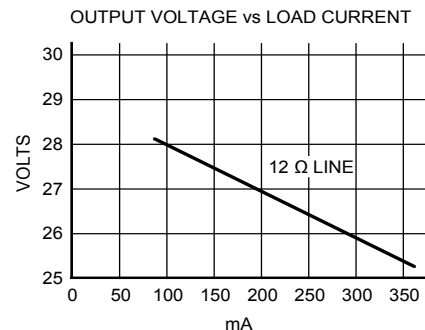

Figure 3. Direct Motor Drive



Figure 4. Self Contained Voltage Doubler



**Input Stage**

The input voltage level of the MIC4421 changes the quiescent supply current. The N channel MOSFET input stage transistor drives a 320µA current source load. With a logic “1” input, the maximum quiescent supply current is 400µA. Logic “0” input level signals reduce quiescent current to 80µA typical.

The MIC4421/4422 input is designed to provide 300mV of hysteresis. This provides clean transitions, reduces noise sensitivity, and minimizes output stage current spiking when changing states. Input voltage threshold level is approximately 1.5V, making the device TTL compatible over the full temperature and operating supply voltage ranges. Input current is less than ±10µA.

The MIC4421 can be directly driven by the TL494, SG1526/1527, SG1524, TSC170, MIC38C42, and similar switch mode power supply integrated circuits. By offloading the power-driving duties to the MIC4421/4422, the power supply controller can operate at lower dissipation. This can improve performance and reliability.

The input can be greater than the  $V_s$  supply, however, current will flow into the input lead. The input currents can be as high as 30mA p-p (6.4mA<sub>RMS</sub>) with the input. No damage will occur to MIC4421/4422 however, and it will not latch.

The input appears as a 7pF capacitance and does not change even if the input is driven from an AC source. While the device will operate and no damage will occur up to 25V below the negative rail, input current will increase up to 1mA/V due to the clamping action of the input, ESD diode, and 1kΩ resistor.

**Power Dissipation**

**CMOS circuits usually permit the user to ignore power dissipation.** Logic families such as 4000 and 74C have outputs which can only supply a few milliamperes of current, and even shorting outputs to ground will not force enough current to destroy the device. The MIC4421/4422 on the other hand, can source or sink several amperes and drive large capacitive loads at high frequency. The package power

dissipation limit can easily be exceeded. Therefore, some attention should be given to power dissipation when driving low impedance loads and/or operating at high frequency.

The supply current vs. frequency and supply current vs. capacitive load characteristic curves aid in determining power dissipation calculations. Table 1 lists the maximum safe operating frequency for several power supply voltages when driving a 10,000pF load. More accurate power dissipation figures can be obtained by summing the three dissipation sources.

Given the power dissipation in the device, and the thermal resistance of the package, junction operating temperature for any ambient is easy to calculate. For example, the thermal resistance of the 8-pin plastic DIP package, from the data sheet, is 130°C/W. In a 25°C ambient, then, using a maximum junction temperature of 150°C, this package will dissipate 960mW.

Accurate power dissipation numbers can be obtained by summing the three sources of power dissipation in the device:

- Load Power Dissipation ( $P_L$ )
- Quiescent power dissipation ( $P_Q$ )
- Transition power dissipation ( $P_T$ )

Calculation of load power dissipation differs depending on whether the load is capacitive, resistive or inductive.

**Resistive Load Power Dissipation**

Dissipation caused by a resistive load can be calculated as:

$$P_L = I^2 R_o D$$

where:

- I = the current drawn by the load
- $R_o$  = the output resistance of the driver when the output is high, at the power supply voltage used. (See data sheet)
- D = fraction of time the load is conducting (duty cycle)

**Table 1: MIC4421 Maximum Operating Frequency**

$V_s$	Max Frequency
18V	220kHz
15V	300kHz
10V	640kHz
5V	2MHz

- Conditions:
1.  $\theta_{JA} = 150^\circ\text{C/W}$
  2.  $T_A = 25^\circ\text{C}$
  3.  $C_L = 10,000\text{pF}$



**Figure 5. Switching Time Degradation Due to Negative Feedback**



### Capacitive Load Power Dissipation

Dissipation caused by a capacitive load is simply the energy placed in, or removed from, the load capacitance by the driver. The energy stored in a capacitor is described by the equation:

$$E = 1/2 C V^2$$

As this energy is lost in the driver each time the load is charged or discharged, for power dissipation calculations the 1/2 is removed. This equation also shows that it is good practice not to place more voltage in the capacitor than is necessary, as dissipation increases as the square of the voltage applied to the capacitor. For a driver with a capacitive load:

$$P_L = f C (V_S)^2$$

where:

f = Operating Frequency

C = Load Capacitance

V<sub>S</sub> = Driver Supply Voltage

### Inductive Load Power Dissipation

For inductive loads the situation is more complicated. For the part of the cycle in which the driver is actively forcing current into the inductor, the situation is the same as it is in the resistive case:

$$P_{L1} = I^2 R_O D$$

However, in this instance the R<sub>O</sub> required may be either the on resistance of the driver when its output is in the high state, or its on resistance when the driver is in the low state, depending on how the inductor is connected, and this is still only half the story. For the part of the cycle when the inductor is forcing current through the driver, dissipation is best described as

$$P_{L2} = I V_D (1 - D)$$

where V<sub>D</sub> is the forward drop of the clamp diode in the driver (generally around 0.7V). The two parts of the load dissipation must be summed in to produce P<sub>L</sub>

$$P_L = P_{L1} + P_{L2}$$

### Quiescent Power Dissipation

Quiescent power dissipation (P<sub>Q</sub>, as described in the input section) depends on whether the input is high or low. A low input will result in a maximum current drain (per driver) of ≤0.2mA; a logic high will result in a current drain of ≤3.0mA. Quiescent power can therefore be found from:

$$P_Q = V_S [D I_H + (1 - D) I_L]$$

where:

I<sub>H</sub> = quiescent current with input high

I<sub>L</sub> = quiescent current with input low

D = fraction of time input is high (duty cycle)

V<sub>S</sub> = power supply voltage

### Transition Power Dissipation

Transition power is dissipated in the driver each time its output changes state, because during the transition, for a very brief interval, both the N- and P-channel MOSFETs in the output totem-pole are ON simultaneously, and a current is conducted through them from V<sub>S</sub> to ground. The transition power dissipation is approximately:

$$P_T = 2 f V_S (A \cdot s)$$

where (A·s) is a time-current factor derived from the typical characteristic curve "Crossover Energy vs. Supply Voltage."

Total power (P<sub>D</sub>) then, as previously described is just

$$P_D = P_L + P_Q + P_T$$

### Definitions

C<sub>L</sub> = Load Capacitance in Farads.

D = Duty Cycle expressed as the fraction of time the input to the driver is high.

f = Operating Frequency of the driver in Hertz

I<sub>H</sub> = Power supply current drawn by a driver when both inputs are high and neither output is loaded.

I<sub>L</sub> = Power supply current drawn by a driver when both inputs are low and neither output is loaded.

I<sub>D</sub> = Output current from a driver in Amps.

P<sub>D</sub> = Total power dissipated in a driver in Watts.

P<sub>L</sub> = Power dissipated in the driver due to the driver's load in Watts.

P<sub>Q</sub> = Power dissipated in a quiescent driver in Watts.

P<sub>T</sub> = Power dissipated in a driver when the output changes states ("shoot-through current") in Watts. NOTE: The "shoot-through" current from a dual transition (once up, once down) for both drivers is stated in Figure 7 in ampere-nanoseconds. This figure must be multiplied by the number of repetitions per second (frequency) to find Watts.

R<sub>O</sub> = Output resistance of a driver in Ohms.

V<sub>S</sub> = Power supply voltage to the IC in Volts.



Figure 6. Peak Output Current Test Circuit

# Package Information



**8-Pin Plastic DIP (N)**



**8-Pin SOIC (M)**

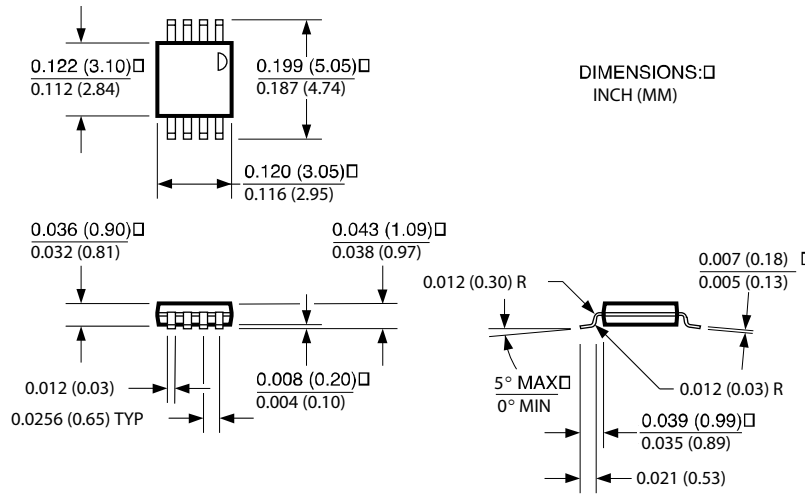

8-Pin MSOP (MM)

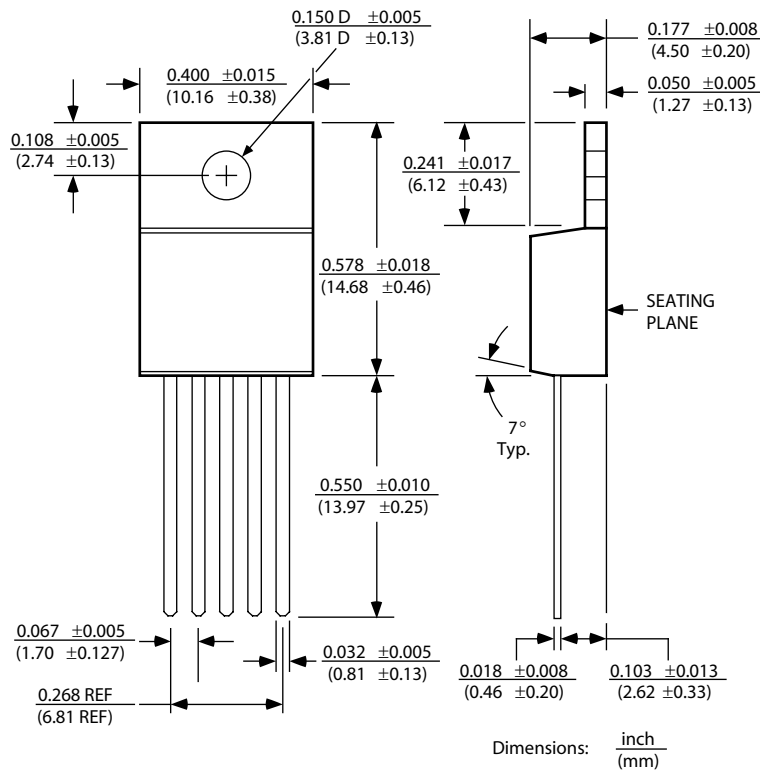

5-Lead TO-220 (T)

**MICREL INC. 2180 FORTUNE DRIVE SAN JOSE, CA 95131 USA**  
 TEL + 1 (408) 944-0800 FAX + 1 (408) 474-1000 WEB <http://www.micrel.com>

This information furnished by Micrel in this data sheet is believed to be accurate and reliable. However no responsibility is assumed by Micrel for its use. Micrel reserves the right to change circuitry and specifications at any time without notification to the customer.

Micrel Products are not designed or authorized for use as components in life support appliances, devices or systems where malfunction of a product can reasonably be expected to result in personal injury. Life support devices or systems are devices or systems that (a) are intended for surgical implant into the body or (b) support or sustain life, and whose failure to perform can be reasonably expected to result in a significant injury to the user. A Purchaser's use or sale of Micrel Products for use in life support appliances, devices or systems is a Purchaser's own risk and Purchaser agrees to fully indemnify Micrel for any damages resulting from such use or sale.



Компания «ЭлектроПласт» предлагает заключение долгосрочных отношений при поставках импортных электронных компонентов на взаимовыгодных условиях!

Наши преимущества:

- Оперативные поставки широкого спектра электронных компонентов отечественного и импортного производства напрямую от производителей и с крупнейших мировых складов;
- Поставка более 17-ти миллионов наименований электронных компонентов;
- Поставка сложных, дефицитных, либо снятых с производства позиций;
- Оперативные сроки поставки под заказ (от 5 рабочих дней);
- Экспресс доставка в любую точку России;
- Техническая поддержка проекта, помощь в подборе аналогов, поставка прототипов;
- Система менеджмента качества сертифицирована по Международному стандарту ISO 9001;
- Лицензия ФСБ на осуществление работ с использованием сведений, составляющих государственную тайну;
- Поставка специализированных компонентов (Xilinx, Altera, Analog Devices, Intersil, Interpoint, Microsemi, Aeroflex, Peregrine, Syfer, Eurofarad, Texas Instrument, Miteq, Cobham, E2V, MA-COM, Hittite, Mini-Circuits, General Dynamics и др.);

Помимо этого, одним из направлений компании «ЭлектроПласт» является направление «Источники питания». Мы предлагаем Вам помощь Конструкторского отдела:

- Подбор оптимального решения, техническое обоснование при выборе компонента;
- Подбор аналогов;
- Консультации по применению компонента;
- Поставка образцов и прототипов;
- Техническая поддержка проекта;
- Защита от снятия компонента с производства.



#### Как с нами связаться

**Телефон:** 8 (812) 309 58 32 (многоканальный)

**Факс:** 8 (812) 320-02-42

**Электронная почта:** [org@eplast1.ru](mailto:org@eplast1.ru)

**Адрес:** 198099, г. Санкт-Петербург, ул. Калинина, дом 2, корпус 4, литера А.