

Inverter Grade Thyristors (Hockey PUK Version), 940 A



TO-200AC (B-PUK)

FEATURES

- Metal case with ceramic insulator
- All diffused design
- Center amplifying gate
- Guaranteed high dV/dt
- Guaranteed high dI/dt
- International standard case TO-200AC (B-PUK)
- High surge current capability
- Low thermal impedance
- High speed performance
- Designed and qualified for industrial level
- Material categorization: for definitions of compliance please see www.vishay.com/doc?99912



**RoHS
COMPLIANT**

PRODUCT SUMMARY

| | |
|--------------------|------------------|
| Package | TO-200AC (B-PUK) |
| Diode variation | Single SCR |
| $I_{T(AV)}$ | 940 A |
| V_{DRM}/V_{RRM} | 400 V, 800 V |
| V_{TM} | 1.63 V |
| I_{TSM} at 50 Hz | 20 000 A |
| I_{TSM} at 60 Hz | 20 950 A |
| I_{GT} | 200 mA |
| T_C/T_{hs} | 55 °C |

TYPICAL APPLICATIONS

- Inverters
- Choppers
- Induction heating
- All types of force-commutated converters

MAJOR RATINGS AND CHARACTERISTICS

| PARAMETER | TEST CONDITIONS | VALUES | UNITS |
|-------------------|-----------------|-------------|-------------------|
| $I_{T(AV)}$ | | 940 | A |
| | T_{hs} | 55 | °C |
| $I_{T(RMS)}$ | | 1900 | A |
| | T_{hs} | 25 | °C |
| I_{TSM} | 50 Hz | 20 000 | A |
| | 60 Hz | 20 950 | |
| I^2t | 50 Hz | 2000 | kA ² s |
| | 60 Hz | 1820 | |
| V_{DRM}/V_{RRM} | | 400 to 800 | V |
| t_q | Range | 10 to 20 | μs |
| T_J | | -40 to +125 | °C |

ELECTRICAL SPECIFICATIONS

VOLTAGE RATINGS

| TYPE NUMBER | VOLTAGE CODE | V_{DRM}/V_{RRM} , MAXIMUM REPETITIVE PEAK VOLTAGE V | V_{RSM} , MAXIMUM NON-REPETITIVE PEAK VOLTAGE V | I_{DRM}/I_{RRM} MAXIMUM AT $T_J = T_J$ MAXIMUM mA |
|--------------|--------------|--|--|--|
| VS-ST733C..L | 04 | 400 | 500 | 75 |
| | 08 | 800 | 900 | |



| CURRENT CARRYING CAPABILITY | | | | | | | |
|----------------------------------|-----------|------|-----------|------|-----------|------|-------|
| FREQUENCY | | | | | | | UNITS |
| 50 Hz | 2200 | 1900 | 3580 | 3100 | 6800 | 5920 | A |
| 400 Hz | 2050 | 1660 | 3600 | 3130 | 3750 | 3240 | |
| 1000 Hz | 1370 | 1070 | 2900 | 2450 | 2120 | 1780 | |
| 2500 Hz | 500 | 370 | 1220 | 980 | 960 | 770 | |
| Recovery voltage V_R | 50 | | 50 | | 50 | | V |
| Voltage before turn-on V_D | V_{DRM} | | V_{DRM} | | V_{DRM} | | |
| Rise of on-state current dI/dt | 50 | | - | | - | | A/μs |
| Heatsink temperature | 40 | 55 | 40 | 55 | 40 | 55 | °C |
| Equivalent values for RC circuit | 10/0.47 | | 10/0.47 | | 10/0.47 | | Ω/μF |

| ABSOLUTE MAXIMUM RATINGS | | | | | |
|--|---------------|--|----------------------------|-----------|--------------------|
| PARAMETER | SYMBOL | TEST CONDITIONS | | VALUES | UNITS |
| Maximum average on-state current at heatsink temperature | $I_{T(AV)}$ | 180° conduction, half sine wave double side (single side) cooled | | 940 (350) | A |
| | | | | 55 (85) | °C |
| Maximum RMS on-state current | $I_{T(RMS)}$ | DC at 25 °C heatsink temperature double side cooled | | 1900 | A |
| Maximum peak, one half cycle, non-repetitive surge current | I_{TSM} | t = 10 ms | No voltage reappplied | 20 000 | |
| | | t = 8.3 ms | | 20 950 | |
| | | t = 10 ms | 100 % V_{RRM} reappplied | 16 800 | |
| | | t = 8.3 ms | | 17 600 | |
| Maximum I^2t for fusing | I^2t | t = 10 ms | No voltage reappplied | 2000 | kA ² s |
| | | t = 8.3 ms | | 1820 | |
| | | t = 10 ms | 100 % V_{RRM} reappplied | 1410 | |
| | | t = 8.3 ms | | 1290 | |
| Maximum $I^2\sqrt{t}$ for fusing | $I^2\sqrt{t}$ | t = 0.1 ms to 10 ms, no voltage reappplied | | 20 000 | kA ² √s |
| Maximum peak on-state voltage | V_{TM} | $I_{TM} = 1700$ A, $T_J = T_J$ maximum, $t_p = 10$ ms sine wave pulse | | 1.63 | V |
| Low level value of threshold voltage | $V_{T(TO)1}$ | $(16.7 \% \times \pi \times I_{T(AV)} < I < \pi \times I_{T(AV)})$, $T_J = T_J$ maximum | | 1.09 | |
| High level value of threshold voltage | $V_{T(TO)2}$ | $(I > \pi \times I_{T(AV)})$, $T_J = T_J$ maximum | | 1.20 | |
| Low level value of forward slope resistance | r_{t1} | $(16.7 \% \times \pi \times I_{T(AV)} < I < \pi \times I_{T(AV)})$, $T_J = T_J$ maximum | | 0.32 | mΩ |
| High level value of forward slope resistance | r_{t2} | $(I > \pi \times I_{T(AV)})$, $T_J = T_J$ maximum | | 0.29 | |
| Maximum holding current | I_H | $T_J = 25$ °C, $I_T > 30$ A | | 600 | mA |
| Typical latching current | I_L | $T_J = 25$ °C, $V_A = 12$ V, $R_a = 6$ Ω, $I_G = 1$ A | | 1000 | |



| SWITCHING | | | | |
|--|----------------|---|--------|-------|
| PARAMETER | SYMBOL | TEST CONDITIONS | VALUES | UNITS |
| Maximum non-repetitive rate of rise of turned-on current | dl/dt | T _J = T _J maximum, V _{DRM} = Rated V _{DRM} , I _{TM} = 2 x dl/dt Gate pulse: 20 V 20 Ω, 10 μs 0.5 μs rise time | 1000 | A/μs |
| Typical delay time | t _d | T _J = 25 °C, V _{DM} = Rated V _{DRM} , I _{TM} = 50 A DC, t _p = 1 μs Resistive load, gate pulse: 10 V, 5 Ω source | 1.5 | μs |
| Maximum turn-off time | minimum | T _J = T _J maximum, I _{TM} = 550 A, commutating dl/dt = 40 A/μs, V _R = 50 V, t _p = 500 μs, dV/dt: see table in device code | 10 | |
| | maximum | | 20 | |

| BLOCKING | | | | |
|--|--|---|--------|-------|
| PARAMETER | SYMBOL | TEST CONDITIONS | VALUES | UNITS |
| Maximum critical rate of rise of off-state voltage | dV/dt | T _J = T _J maximum, linear to 80 % V _{DRM} , higher value available on request | 500 | V/μs |
| Maximum peak reverse and off-state leakage current | I _{RRM} , I _{DRM} | T _J = T _J maximum, rated V _{DRM} /V _{RRM} applied | 75 | mA |

| TRIGGERING | | | | |
|---|--------------------|---|--------|-------|
| PARAMETER | SYMBOL | TEST CONDITIONS | VALUES | UNITS |
| Maximum peak gate power | P _{GM} | T _J = T _J maximum, f = 50 Hz, d% = 50 | 60 | W |
| Maximum average gate power | P _{G(AV)} | | 10 | |
| Maximum peak positive gate current | I _{GM} | T _J = T _J maximum, t _p ≤ 5 ms | 10 | A |
| Maximum peak positive gate voltage | +V _{GM} | | 20 | V |
| Maximum peak negative gate voltage | -V _{GM} | | 5 | |
| Maximum DC gate current required to trigger | I _{GT} | T _J = 25 °C, V _A = 12 V, R _a = 6 Ω | 200 | mA |
| Maximum DC gate voltage required to trigger | V _{GT} | | 3 | V |
| Maximum DC gate current not to trigger | I _{GD} | T _J = T _J maximum, rated V _{DRM} applied | 20 | mA |
| Maximum DC gate voltage not to trigger | V _{GD} | | 0.25 | V |

| THERMAL AND MECHANICAL SPECIFICATIONS | | | | |
|--|---------------------|---|------------------|-----------|
| PARAMETER | SYMBOL | TEST CONDITIONS | VALUES | UNITS |
| Maximum operating junction temperature range | T _J | | -40 to +125 | °C |
| Maximum storage temperature range | T _{Stg} | | -40 to +150 | |
| Maximum thermal resistance, junction to heatsink | R _{thJ-hs} | DC operation single side cooled | 0.073 | K/W |
| | | DC operation double side cooled | 0.031 | |
| Maximum thermal resistance, case to heatsink | R _{thC-hs} | DC operation single side cooled | 0.011 | |
| | | DC operation double side cooled | 0.005 | |
| Mounting force, ± 10 % | | | 14 700 (1500) | N (kg) |
| Approximate weight | | | 255 | g |
| Case style | | See dimensions - link at the end of datasheet | TO-200AC (B-PUK) | |



| ΔR_{thJ-hs} CONDUCTION | | | | | | |
|--|-----------------------|-------------|------------------------|-------------|---|-------|
| CONDUCTION ANGLE | SINUSOIDAL CONDUCTION | | RECTANGULAR CONDUCTION | | TEST CONDITIONS | UNITS |
| | SINGLE SIDE | DOUBLE SIDE | SINGLE SIDE | DOUBLE SIDE | | |
| 180° | 0.009 | 0.009 | 0.006 | 0.006 | T _J = T _J maximum | K/W |
| 120° | 0.011 | 0.011 | 0.011 | 0.011 | | |
| 90° | 0.014 | 0.014 | 0.015 | 0.015 | | |
| 60° | 0.020 | 0.021 | 0.021 | 0.022 | | |
| 30° | 0.036 | 0.036 | 0.036 | 0.036 | | |

Note

- The table above shows the increment of thermal resistance R_{thJ-hs} when devices operate at different conduction angles than DC

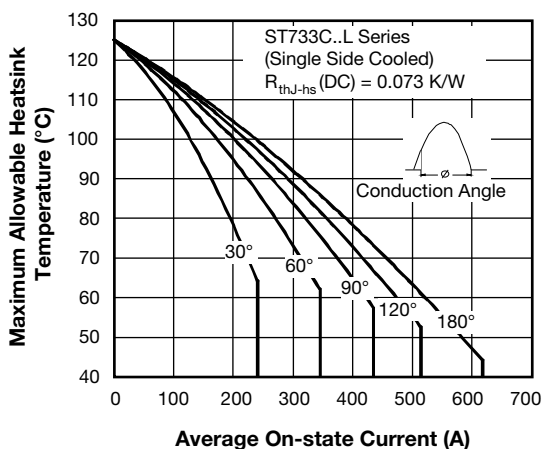

Fig. 1 - Current Ratings Characteristics

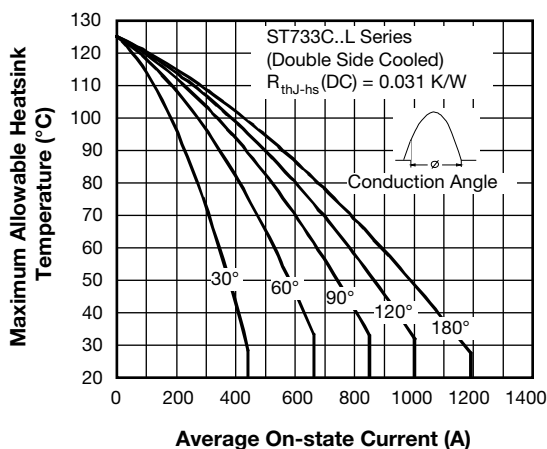

Fig. 3 - Current Ratings Characteristics

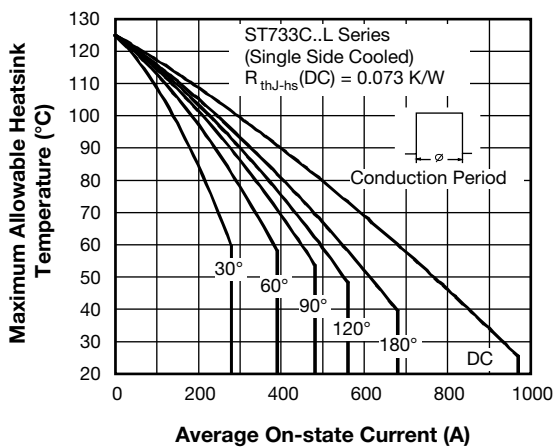

Fig. 2 - Current Ratings Characteristics

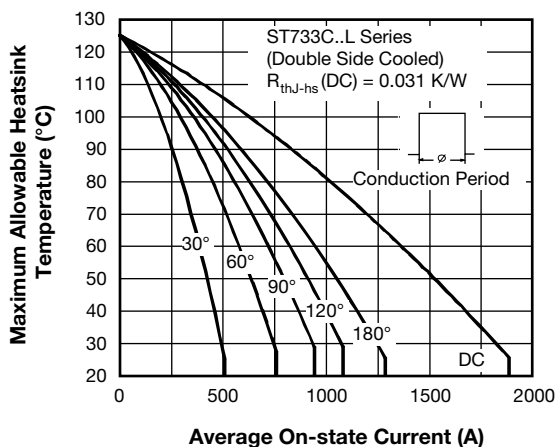

Fig. 4 - Current Ratings Characteristics

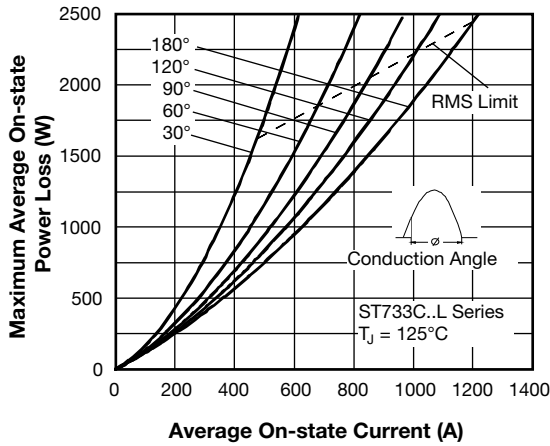

Fig. 5 - On-State Power Loss Characteristics

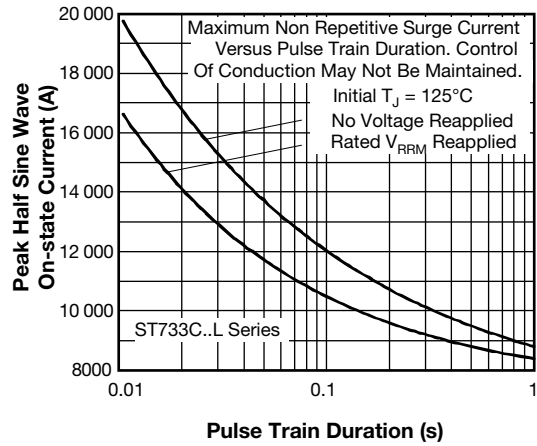

Fig. 8 - Maximum Non-Repetitive Surge Current Single and Double Side Cooled

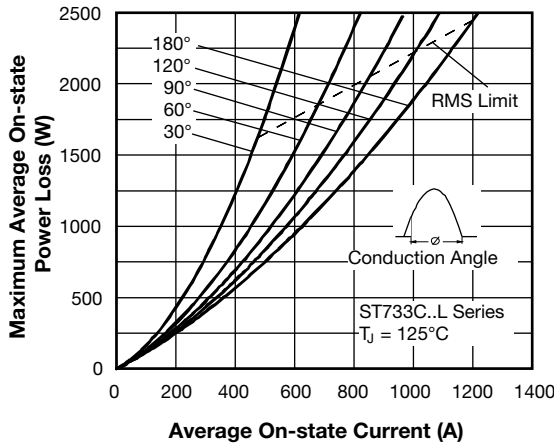

Fig. 6 - On-State Power Loss Characteristics

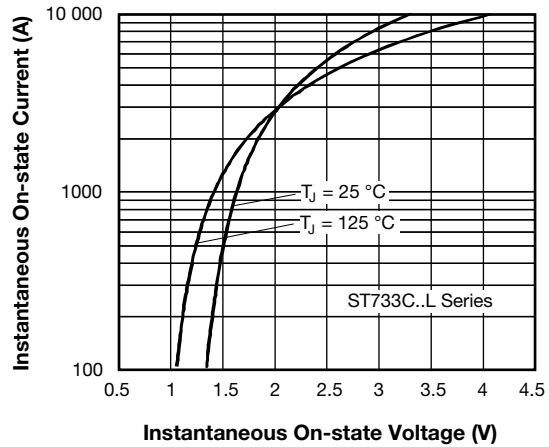

Fig. 9 - On-State Voltage Drop Characteristics

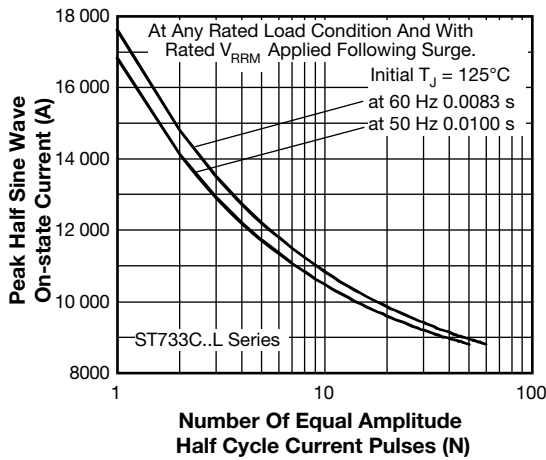

Fig. 7 - Maximum Non-Repetitive Surge Current Single and Double Side Cooled

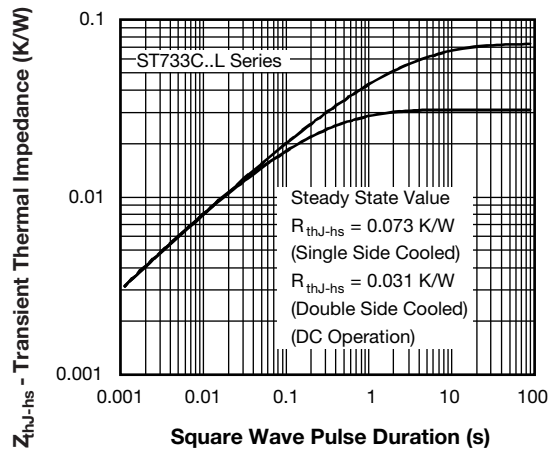

Fig. 10 - Thermal Impedance Z_{thJC} Characteristics

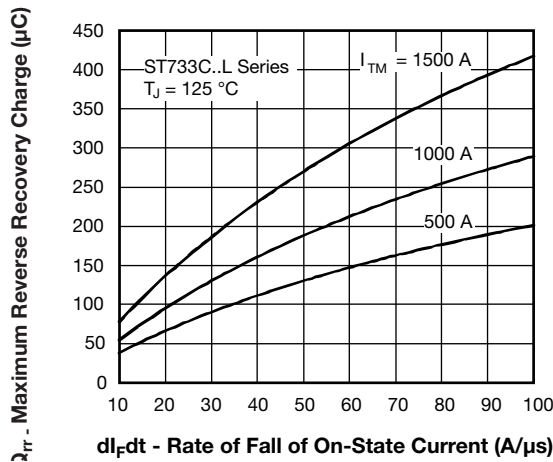

Fig. 11 - Reverse Recovered Charge Characteristics

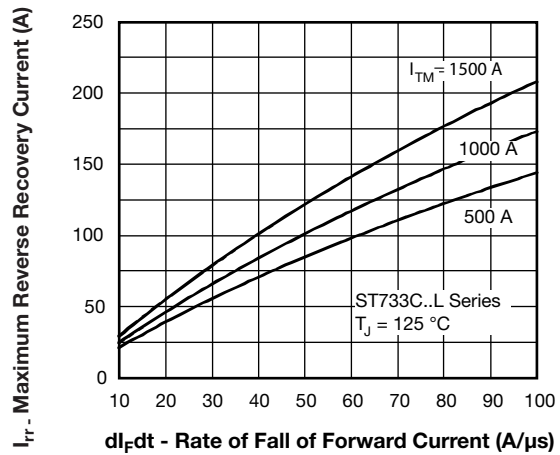

Fig. 12 - Reverse Recovered Current Characteristics

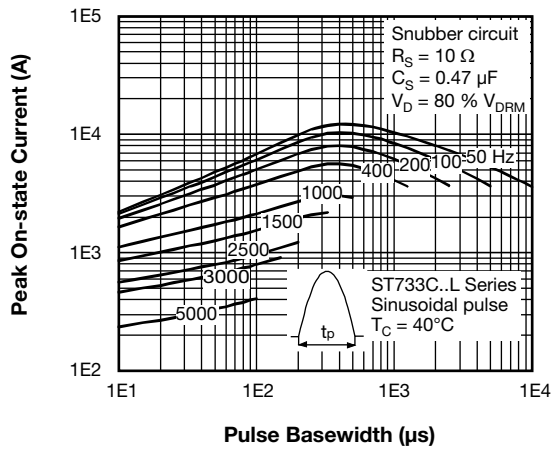

Fig. 13 - Frequency Characteristics

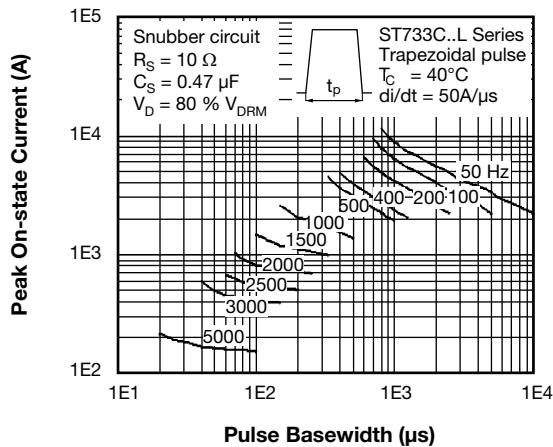
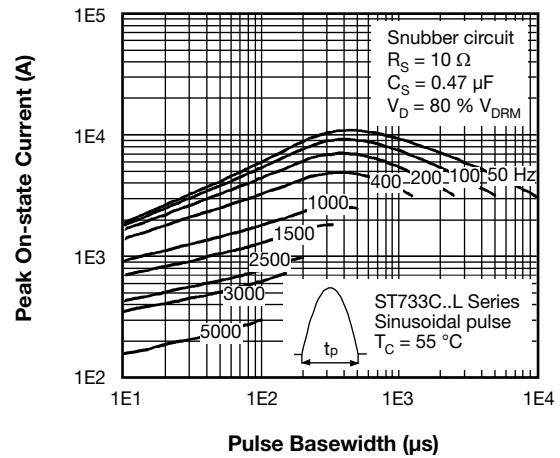
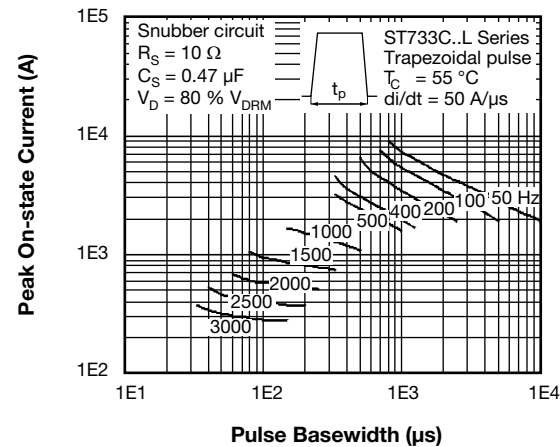

Fig. 14 - Frequency Characteristics



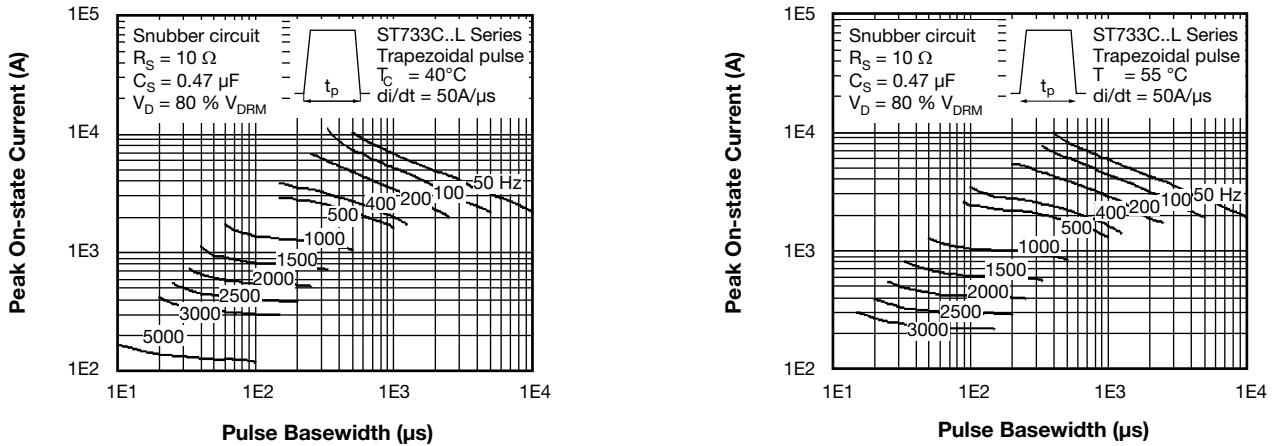

Fig. 15 - Frequency Characteristics

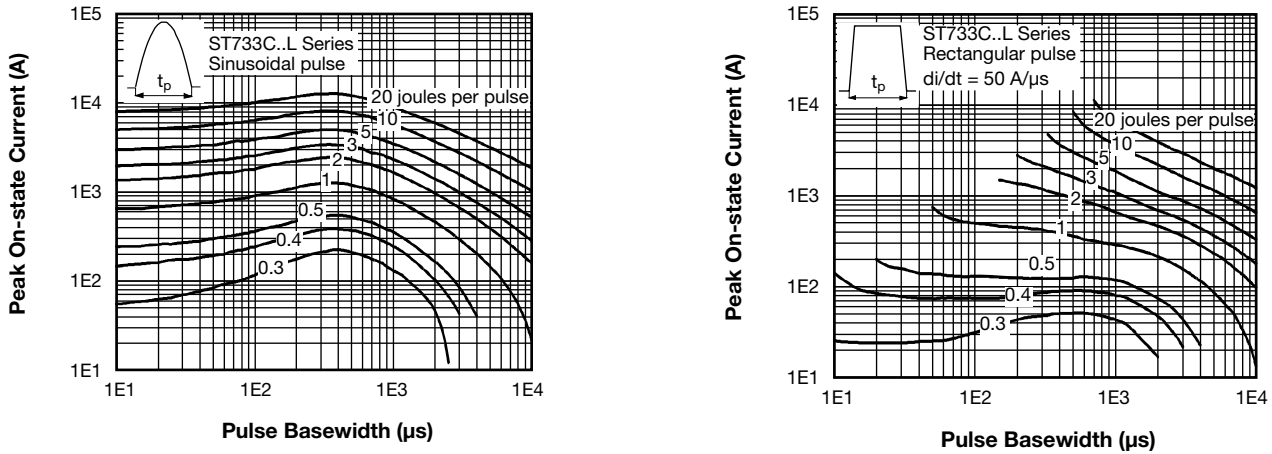

Fig. 16 - Maximum On-State Energy Power Loss Characteristics

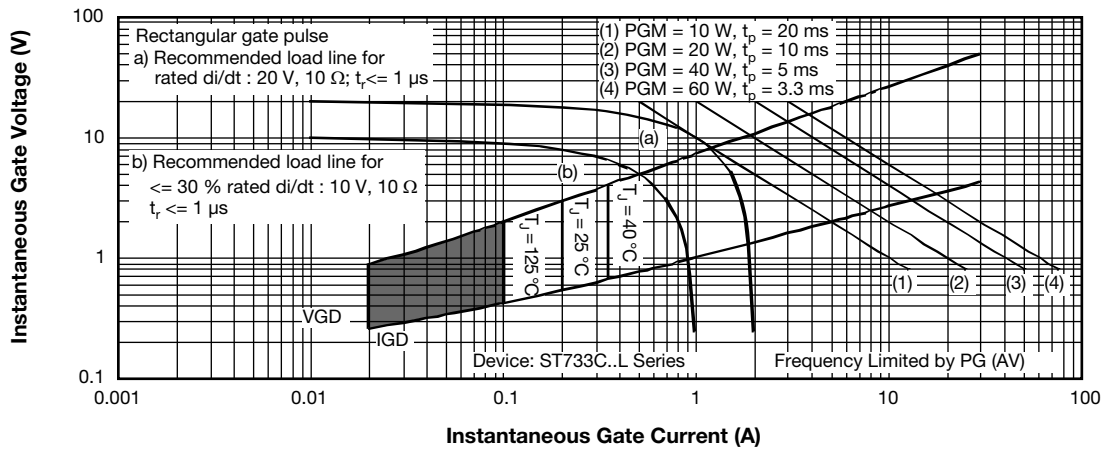

Fig. 17 - Gate Characteristics



ORDERING INFORMATION TABLE

| | | | | | | | | | | | |
|-------------|------------|-----------|-----------|----------|----------|-----------|----------|----------|----------|----------|----------|
| Device code | VS- | ST | 73 | 3 | C | 08 | L | H | K | 1 | - |
| | ① | ② | ③ | ④ | ⑤ | ⑥ | ⑦ | ⑧ | ⑨ | ⑩ | ⑪ |

- 1** - Vishay Semiconductors product
- 2** - Thyristor
- 3** - Essential part number
- 4** - 3 = fast turn-off
- 5** - C = ceramic PUK
- 6** - Voltage code x 100 = V_{RRM}
(see Voltage Ratings table)
- 7** - L = PUK case TO-200AC (B-PUK)
- 8** - Reapplied dV/dt code (for t_q test condition)
- 9** - t_q code
- 10** - 0 = eyelet terminals
(gate and auxiliary cathode unsoldered leads)
1 = fast-on terminals
(gate and auxiliary cathode unsoldered leads)
2 = eyelet terminals
(gate and auxiliary cathode soldered leads)
3 = fast-on terminals
(gate and auxiliary cathode soldered leads)
- 11** - Critical dV/dt:
 - None = 500 V/ μ s (standard value)
 - L = 1000 V/ μ s (special selection)

| dV/dt - t_q combinations available | | | | | | |
|--------------------------------------|--------------------|----|----|-----|-----|-----|
| | dV/dt (V/ μ s) | 20 | 50 | 100 | 200 | 400 |
| t_q (μ s) | 10 | CN | DN | EN | - | - |
| | 12 | CM | DM | EM | FM* | - |
| | 15 | CL | DL | EL | FL* | HL |
| | 18 | CP | DP | EP | FP | HP |
| | 20 | CK | DK | EK | FK | H |

* Standard part number.
All other types available only on request.

| LINKS TO RELATED DOCUMENTS | |
|----------------------------|--|
| Dimensions | www.vishay.com/doc?95076 |

TO-200AC (B-PUK)

DIMENSIONS in millimeters (inches)

Creepage distance: 36.33 (1.430) minimum
 Strike distance: 17.43 (0.686) minimum

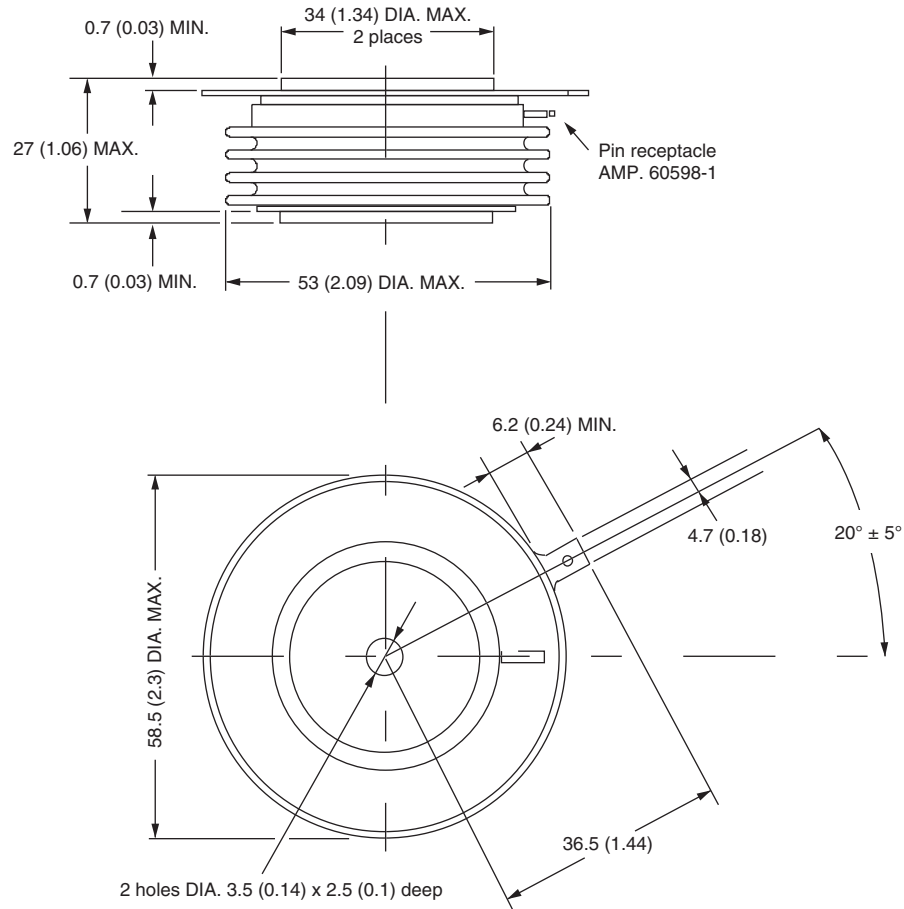

Quote between upper and lower pole pieces has to be considered after application of mounting force (see thermal and mechanical specification)



Disclaimer

ALL PRODUCT, PRODUCT SPECIFICATIONS AND DATA ARE SUBJECT TO CHANGE WITHOUT NOTICE TO IMPROVE RELIABILITY, FUNCTION OR DESIGN OR OTHERWISE.

Vishay Intertechnology, Inc., its affiliates, agents, and employees, and all persons acting on its or their behalf (collectively, "Vishay"), disclaim any and all liability for any errors, inaccuracies or incompleteness contained in any datasheet or in any other disclosure relating to any product.

Vishay makes no warranty, representation or guarantee regarding the suitability of the products for any particular purpose or the continuing production of any product. To the maximum extent permitted by applicable law, Vishay disclaims (i) any and all liability arising out of the application or use of any product, (ii) any and all liability, including without limitation special, consequential or incidental damages, and (iii) any and all implied warranties, including warranties of fitness for particular purpose, non-infringement and merchantability.

Statements regarding the suitability of products for certain types of applications are based on Vishay's knowledge of typical requirements that are often placed on Vishay products in generic applications. Such statements are not binding statements about the suitability of products for a particular application. It is the customer's responsibility to validate that a particular product with the properties described in the product specification is suitable for use in a particular application. Parameters provided in datasheets and/or specifications may vary in different applications and performance may vary over time. All operating parameters, including typical parameters, must be validated for each customer application by the customer's technical experts. Product specifications do not expand or otherwise modify Vishay's terms and conditions of purchase, including but not limited to the warranty expressed therein.

Except as expressly indicated in writing, Vishay products are not designed for use in medical, life-saving, or life-sustaining applications or for any other application in which the failure of the Vishay product could result in personal injury or death. Customers using or selling Vishay products not expressly indicated for use in such applications do so at their own risk. Please contact authorized Vishay personnel to obtain written terms and conditions regarding products designed for such applications.

No license, express or implied, by estoppel or otherwise, to any intellectual property rights is granted by this document or by any conduct of Vishay. Product names and markings noted herein may be trademarks of their respective owners.

Material Category Policy

Vishay Intertechnology, Inc. hereby certifies that all its products that are identified as RoHS-Compliant fulfill the definitions and restrictions defined under Directive 2011/65/EU of The European Parliament and of the Council of June 8, 2011 on the restriction of the use of certain hazardous substances in electrical and electronic equipment (EEE) - recast, unless otherwise specified as non-compliant.

Please note that some Vishay documentation may still make reference to RoHS Directive 2002/95/EC. We confirm that all the products identified as being compliant to Directive 2002/95/EC conform to Directive 2011/65/EU.

Vishay Intertechnology, Inc. hereby certifies that all its products that are identified as Halogen-Free follow Halogen-Free requirements as per JEDEC JS709A standards. Please note that some Vishay documentation may still make reference to the IEC 61249-2-21 definition. We confirm that all the products identified as being compliant to IEC 61249-2-21 conform to JEDEC JS709A standards.



Компания «ЭлектроПласт» предлагает заключение долгосрочных отношений при поставках импортных электронных компонентов на взаимовыгодных условиях!

Наши преимущества:

- Оперативные поставки широкого спектра электронных компонентов отечественного и импортного производства напрямую от производителей и с крупнейших мировых складов;
- Поставка более 17-ти миллионов наименований электронных компонентов;
- Поставка сложных, дефицитных, либо снятых с производства позиций;
- Оперативные сроки поставки под заказ (от 5 рабочих дней);
- Экспресс доставка в любую точку России;
- Техническая поддержка проекта, помощь в подборе аналогов, поставка прототипов;
- Система менеджмента качества сертифицирована по Международному стандарту ISO 9001;
- Лицензия ФСБ на осуществление работ с использованием сведений, составляющих государственную тайну;
- Поставка специализированных компонентов (Xilinx, Altera, Analog Devices, Intersil, Interpoint, Microsemi, Aeroflex, Peregrine, Syfer, Eurofarad, Texas Instrument, Miteq, Cobham, E2V, MA-COM, Hittite, Mini-Circuits, General Dynamics и др.);

Помимо этого, одним из направлений компании «ЭлектроПласт» является направление «Источники питания». Мы предлагаем Вам помощь Конструкторского отдела:

- Подбор оптимального решения, техническое обоснование при выборе компонента;
- Подбор аналогов;
- Консультации по применению компонента;
- Поставка образцов и прототипов;
- Техническая поддержка проекта;
- Защита от снятия компонента с производства.



Как с нами связаться

Телефон: 8 (812) 309 58 32 (многоканальный)

Факс: 8 (812) 320-02-42

Электронная почта: org@eplast1.ru

Адрес: 198099, г. Санкт-Петербург, ул. Калинина, дом 2, корпус 4, литера А.