

# HDSP-511x, HDSP-513x and HDSP-515A

## 14.22 mm (0.56 inch) General Purpose Seven-Segment Display



### Data Sheet



#### Description

This 14.22 mm (0.56 inch) LED seven-segment display uses industry standard size package and pinout. The device is available in either common anode or common cathode. The choice of colors includes High Efficiency Red (HER), Green, AlGaAs Red, and Yellow. The displays are suitable for indoor use.

#### Applications

- Suitable for indoor use
- Not recommended for industrial application i.e., operating temperature requirements exceeding +85°C or below -25°C [1]
- Extreme temperature cycling not recommended

Note 1. For additional details, please contact your local Avago sales office or an authorized distributor.

#### Features

- Industry standard size
- Industry standard pinout  
14.22 mm (0.56 inch)  
DIP lead on 2.54 mm
- Choice of colors  
High Efficiency Red (HER), Green, AlGaAs Red, and Yellow
- Excellent appearance  
Evenly lighted segments package gives optimum contrast  
± 50° viewing angle
- Design flexibility  
Common anode or common cathode  
Single digit  
Right hand decimal point
- Categorized for luminous intensity  
Green and yellow categorized for color

#### Devices

HER	Green	AlGaAs Red	Yellow	Description
HDSP-511E	HDSP-511G	HDSP-511A	HDSP-511Y	Common Anode, Gray Surface, Right Hand Decimal
HDSP-513E	HDSP-513G	HDSP-513A	HDSP-513Y	Common Cathode, Gray Surface, Right Hand Decimal
-	-	HDSP-515A	-	Common Cathode, Black Surface, Right Hand Decimal

## Part Numbering System

5082 -X X X X-X X X X X  
HDSP-X X X X-X X X X X

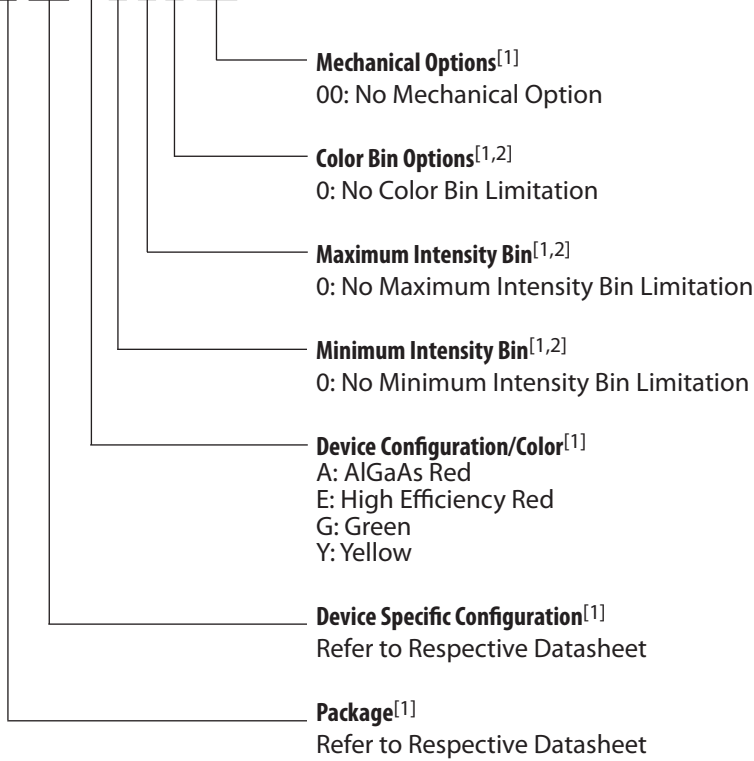

### Notes:

1. For codes not listed in the figure above, please refer to the respective datasheet or contact your nearest Avago representative for details.
2. Bin options refer to shippable bins for a part number. Color and Intensity Bins are typically restricted to 1 bin per tube (exceptions may apply). Please refer to respective datasheet for specific bin limit information.

## Package Dimensions

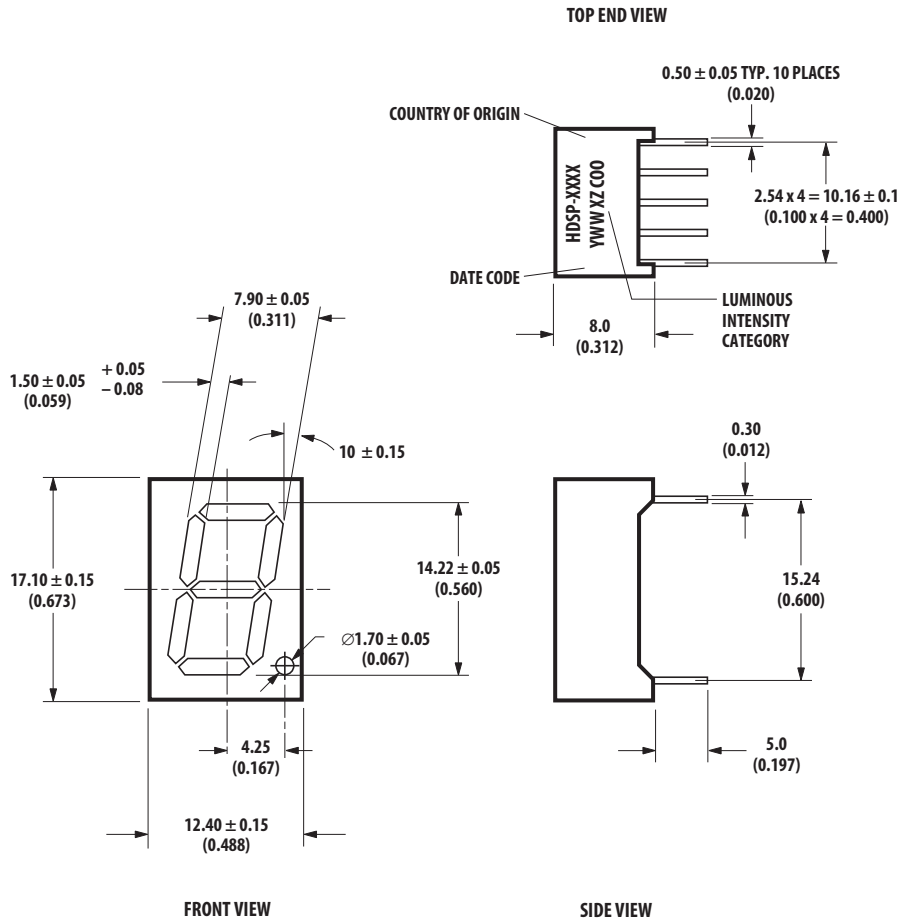

ALL DIMENSIONS ARE IN MILLIMETERS (INCHES).

## Internal Circuit Diagram

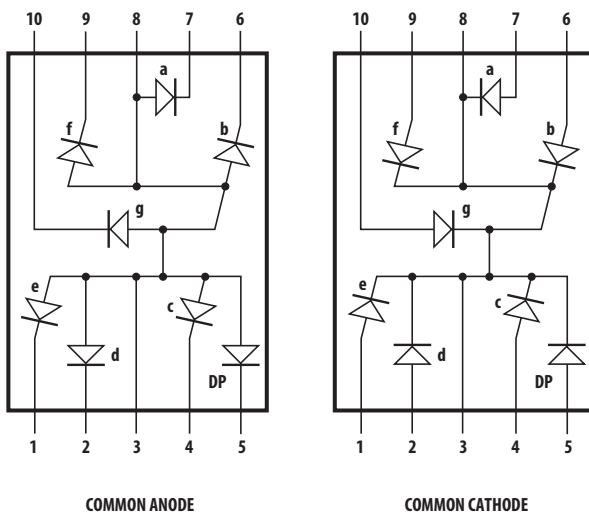

HDSP-511E/511G/511Y/511A		HDSP-513E/513G/513Y/513A	
COMMON ANODE		COMMON CATHODE	
PIN	FUNCTION	PIN	FUNCTION
1	CATHODE e	1	ANODE e
2	CATHODE d	2	ANODE d
3	COMMON ANODE	3	COMMON CATHODE
4	CATHODE c	4	ANODE c
5	CATHODE DP	5	ANODE DP
6	CATHODE b	6	ANODE b
7	CATHODE a	7	ANODE a
8	COMMON ANODE	8	COMMON CATHODE
9	CATHODE f	9	ANODE f
10	CATHODE g	10	ANODE g

### Absolute Maximum Ratings at T<sub>A</sub> = 25°C

Description	HER HDSP-51xE	Green HDSP-51xG	AlGaAs Red HDSP-51xA	Yellow HDSP-51xY	Units
Power Dissipation Segment	60	65	30	52	mW
Forward Current Segment	25 <sup>[1]</sup>	25 <sup>[2]</sup>	15 <sup>[3]</sup>	20 <sup>[4]</sup>	mA
Peak Forward Current per Segment (1/10 Duty Factor at 10 KHz)	100	100	80	80	mA
Operating Temperature Range	-35 to +85	-35 to +85	-35 to +85	-35 to +85	°C
Storage Temperature Range	-35 to +85	-35 to +85	-35 to +85	-35 to +85	°C
Reverse Voltage per Segment or DP	5	5	5	5	V
Wavesoldering Temperature for 3 seconds (at 2 mm Distance from the body)	250	250	250	250	°C

Notes:

1. Derate above 25°C at 0.33 mA/°C.
2. Derate above 25°C at 0.33 mA/°C.
3. Derate above 25°C at 0.2 mA/°C.
4. Derate above 25°C at 0.27 mA/°C.

### Electrical/Optical Characteristics at T<sub>A</sub> = 25°C

#### High Efficiency Red (HER)

Device	Parameter	Symbol	Min.	Typ.	Max.	Units	Test Conditions
511E	Luminous Intensity/Segment	I <sub>V</sub>		1.73		mcd	I <sub>F</sub> = 5 mA
513E			2.001	4.100		mcd	I <sub>F</sub> = 10 mA
	Forward Voltage	V <sub>F</sub>		2.05	2.40	V	I <sub>F</sub> = 20 mA
	Peak Wavelength	λ <sub>PEAK</sub>		635		nm	
	Dominant Wavelength	λ <sub>d</sub>		620		nm	
	Reverse Voltage	V <sub>R</sub>	5			V	I <sub>R</sub> = 100 μA

#### Green

Device	Parameter	Symbol	Min.	Typ.	Max.	Units	Test Conditions
511G	Luminous Intensity/Segment	I <sub>V</sub>	2.001	4.100		mcd	I <sub>F</sub> = 10 mA
513G	Forward Voltage	V <sub>F</sub>		2.06		V	I <sub>F</sub> = 10 mA
			1.80	2.25	2.60	V	I <sub>F</sub> = 20 mA
	Peak Wavelength	λ <sub>PEAK</sub>		568		nm	
	Dominant Wavelength	λ <sub>d</sub>		573		nm	
	Reverse Voltage	V <sub>R</sub>	5			V	I <sub>R</sub> = 100 μA

## AlGaAs Red

Device	Parameter	Symbol	Min.	Typ.	Max.	Units	Test Conditions
511A	Luminous Intensity/Segment	$I_V$	3.201	4.93		mcd	$I_F = 5 \text{ mA}$
513A				6.500		mcd	$I_F = 10 \text{ mA}$
515A	Forward Voltage	$V_F$		1.85	2.00	V	$I_F = 20 \text{ mA}$
	Peak Wavelength	$\lambda_{PEAK}$		660		nm	
	Dominant Wavelength	$\lambda_d$		643		nm	
	Reverse Voltage	$V_R$	5			V	$I_R = 100 \mu\text{A}$

## Yellow

Device	Parameter	Symbol	Min.	Typ.	Max.	Units	Test Conditions
511Y	Luminous Intensity/Segment	$I_V$	1.251	1.03		mcd	$I_F = 5 \text{ mA}$
513Y				2.600		mcd	$I_F = 10 \text{ mA}$
	Forward Voltage	$V_F$		2.15	2.60	V	$I_F = 20 \text{ mA}$
	Peak Wavelength	$\lambda_{PEAK}$		595		nm	
	Dominant Wavelength	$\lambda_d$		590		nm	
	Reverse Voltage	$V_R$	5			V	$I_R = 100 \mu\text{A}$

## Intensity Bin Limits (mcd at 10 mA)

Bin Name	HER/Green		Yellow		AlGaAs Red	
	Min. <sup>[1]</sup>	Max. <sup>[1]</sup>	Min. <sup>[1]</sup>	Max. <sup>[1]</sup>	Min. <sup>[1]</sup>	Max. <sup>[1]</sup>
H	NA	NA	1.251	2.000	NA	NA
I	2.001	3.200	2.001	3.200	NA	NA
J	3.201	5.050	3.201	5.050	3.201	5.050
K	5.051	8.000	NA	NA	5.051	8.000
L	NA	NA	NA	NA	8.001	12.650

Note:

1. Tolerance for each bin limit is  $\pm 10\%$ .

## Color Bin Limits (nm at 10 mA)

Color	Bin	Dominant Wavelength (nm)	
		Min. <sup>[1]</sup>	Max. <sup>[1]</sup>
Green	3	569.1	571.0
	4	571.1	573.0
	5	573.1	575.0
Yellow	1	585.5	588.5
	2	588.5	591.5
	3	591.5	594.5

Note:

1. Tolerance for each bin limit is 1 nm.

### High Efficiency Red (HER)

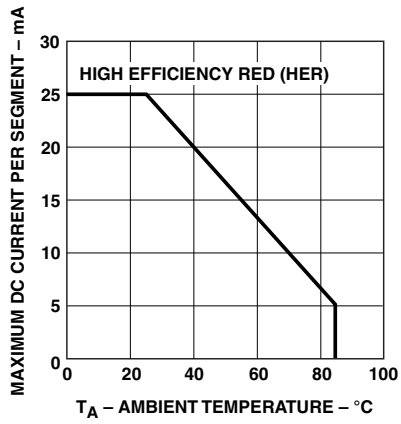

Figure 1. Maximum allowable average or DC current vs. ambient temperature.

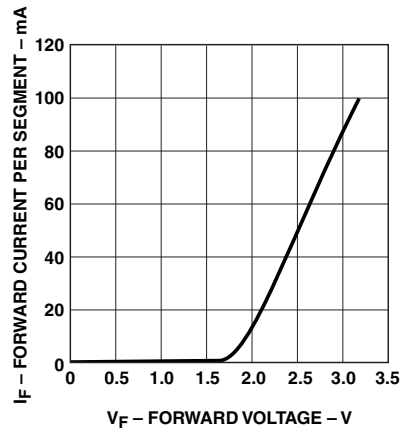

Figure 2. Forward current vs. forward voltage.

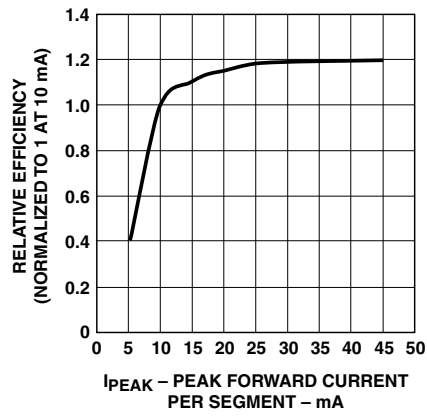

Figure 3. Relative luminous intensity vs. DC forward current.

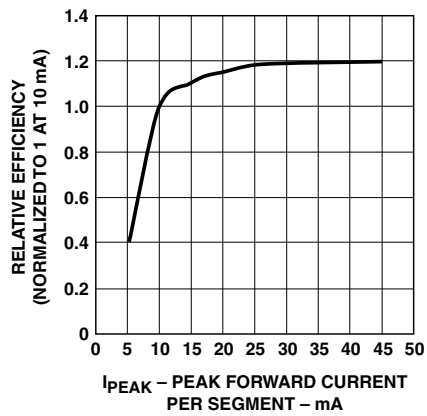

Figure 4. Relative efficiency (luminous intensity per unit current) vs. peak current.

Green

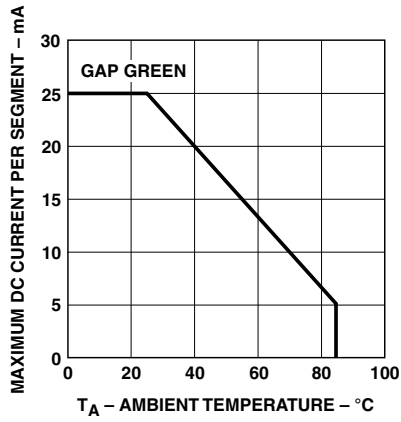

Figure 5. Maximum allowable average or DC current vs. ambient temperature.

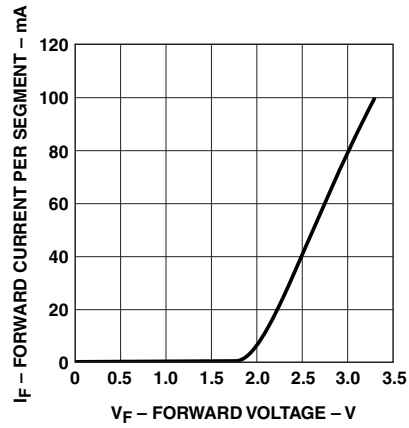

Figure 6. Forward current vs. forward voltage.

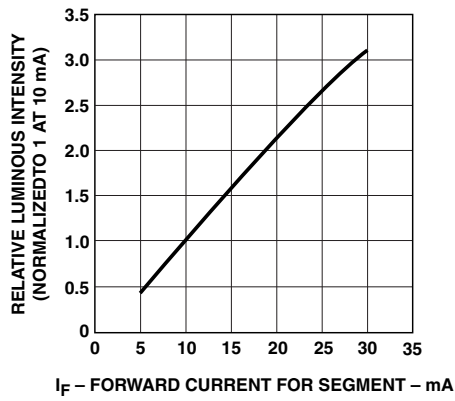

Figure 7. Relative luminous intensity vs. DC forward current.

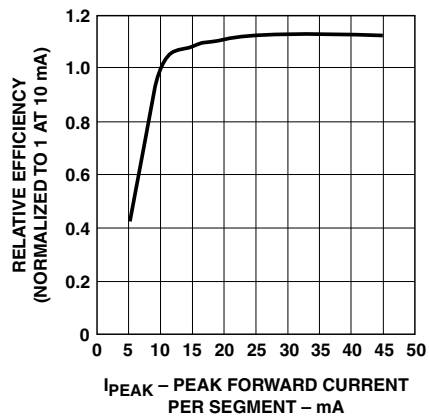

Figure 8. Relative efficiency (luminous intensity per unit current) vs. peak current.

**AlGaAs Red**

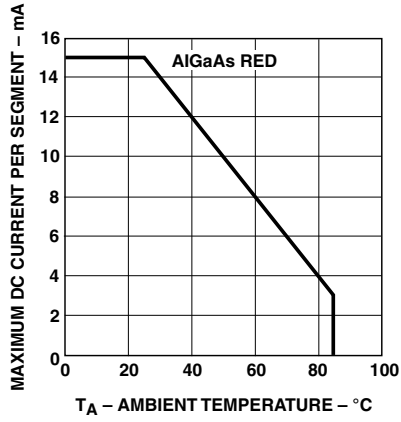

Figure 9. Maximum allowable average or DC current vs. ambient temperature.

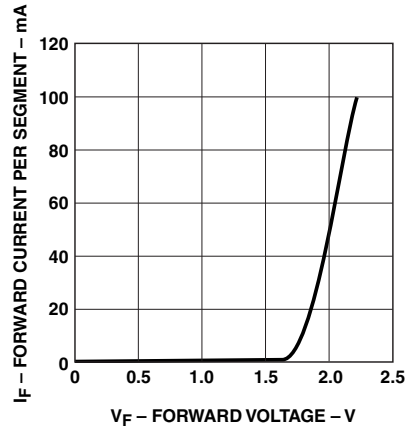

Figure 10. Forward current vs. forward voltage.

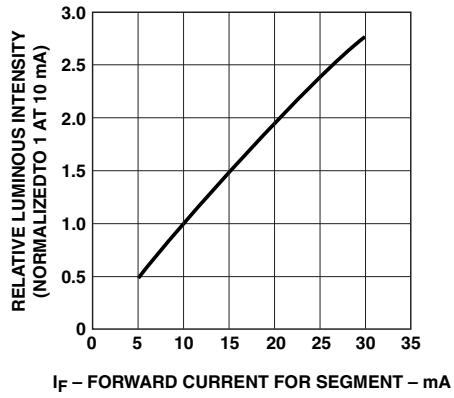

Figure 11. Relative luminous intensity vs. DC forward current.

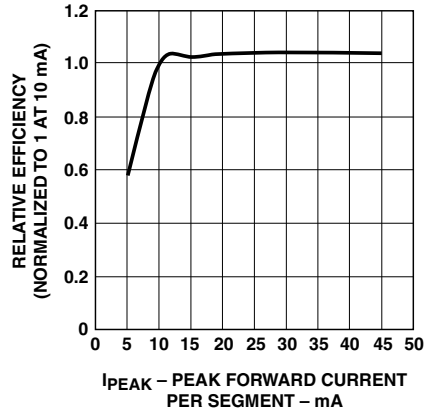

Figure 12. Relative efficiency (luminous intensity per unit current) vs. peak current.



**Yellow**

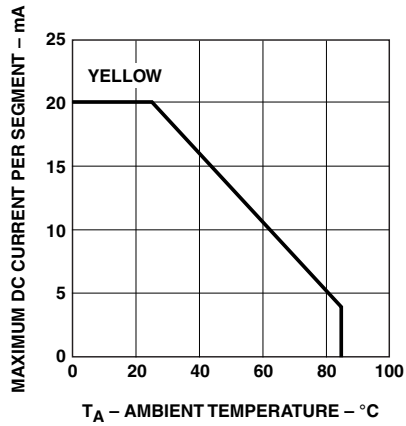

Figure 13. Maximum allowable average or DC current vs. ambient temperature.

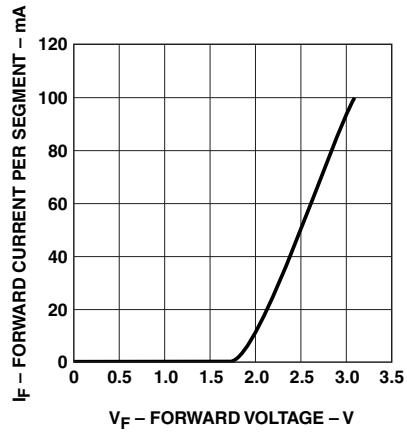

Figure 14. Forward current vs. forward voltage.

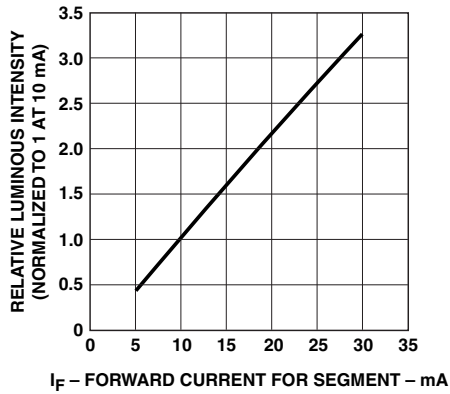

Figure 15. Relative luminous intensity vs. DC forward current.

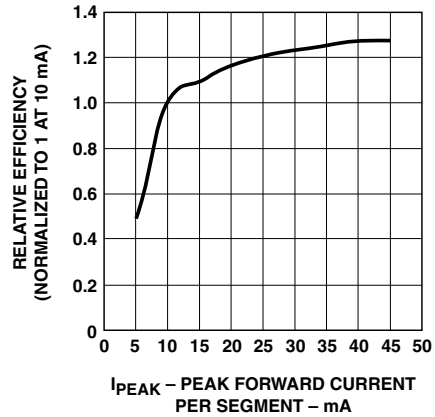

Figure 16. Relative efficiency (luminous intensity per unit current) vs. peak current.

For product information and a complete list of distributors, please go to our website: [www.avagotech.com](http://www.avagotech.com)

Avago, Avago Technologies, and the A logo are trademarks of Avago Technologies Limited in the United States and other countries. Data subject to change. Copyright © 2005-2008 Avago Technologies Limited. All rights reserved. Obsoletes 5988-2968EN AV02-1363EN - June 21, 2008





Компания «ЭлектроПласт» предлагает заключение долгосрочных отношений при поставках импортных электронных компонентов на взаимовыгодных условиях!

Наши преимущества:

- Оперативные поставки широкого спектра электронных компонентов отечественного и импортного производства напрямую от производителей и с крупнейших мировых складов;
- Поставка более 17-ти миллионов наименований электронных компонентов;
- Поставка сложных, дефицитных, либо снятых с производства позиций;
- Оперативные сроки поставки под заказ (от 5 рабочих дней);
- Экспресс доставка в любую точку России;
- Техническая поддержка проекта, помощь в подборе аналогов, поставка прототипов;
- Система менеджмента качества сертифицирована по Международному стандарту ISO 9001;
- Лицензия ФСБ на осуществление работ с использованием сведений, составляющих государственную тайну;
- Поставка специализированных компонентов (Xilinx, Altera, Analog Devices, Intersil, Interpoint, Microsemi, Aeroflex, Peregrine, Syfer, Eurofarad, Texas Instrument, Miteq, Cobham, E2V, MA-COM, Hittite, Mini-Circuits, General Dynamics и др.);

Помимо этого, одним из направлений компании «ЭлектроПласт» является направление «Источники питания». Мы предлагаем Вам помощь Конструкторского отдела:

- Подбор оптимального решения, техническое обоснование при выборе компонента;
- Подбор аналогов;
- Консультации по применению компонента;
- Поставка образцов и прототипов;
- Техническая поддержка проекта;
- Защита от снятия компонента с производства.



#### Как с нами связаться

**Телефон:** 8 (812) 309 58 32 (многоканальный)

**Факс:** 8 (812) 320-02-42

**Электронная почта:** [org@eplast1.ru](mailto:org@eplast1.ru)

**Адрес:** 198099, г. Санкт-Петербург, ул. Калинина, дом 2, корпус 4, литера А.