

Stable Contact Reliability and Long Life

- Easy to mount, wire, and use.
- A large selection of models including various contact forms, DC-switching models, and open models.
- Mechanical life: 5,000,000 operations; electrical life (under rated load): 500,000 operations.
- Models also available with built-in diodes and for use as auxiliary power relays.



 Refer to *Safety Precautions for All Relays*.

Ordering Information

Type	Contact form	Open structure		Cased
		Solder terminals	Screw terminals	Plug-in (octal pins) terminals
Standard	DPDT	MM2	MM2B	MM2P
	3PDT	MM3	MM3B	MM3P
	4PDT	MM4	MM4B	MM4P
DC-switching	DPDT	MM2X	MM2XB	MM2XP
	3PDT	MM3X	MM3XB	MM3XP
	4PDT	MM4X	MM4XB	MM4XP
With built-in diode	DPDT	---	---	MM2P-D
	4PDT	---	---	MM4P-D
DC-switching with built-in diode	DPDT	---	---	MM2XP-D
	4PDT	---	---	MM4XP-D
With operation indicator	DPDT	---	---	MM2PN
	3PDT	---	---	MM3PN
	4PDT	---	---	MM4PN
DC-switching with operation indicator	DPDT	---	---	MM2XPN
	3PDT	---	---	MM3XPN
	4PDT	---	---	MM4XPN
Conforming to auxiliary power relay specifications	4PDT	---	---	MM4P-JD
		---	---	MM4XP-JD

Available Models

Open Coils (with Solder Terminals)

Type	Contact form	Relay model	Available rated voltage
Standard	DP	MM2	6, 12, 24, 50, 100/(110), 200/(220) VAC 6, 12, 24, 48, 100/110, 200/220 VDC
	3P	MM3	100/(110), 200/(220) VAC 6, 12, 24, 48, 200/220 VDC
	4P	MM4	24, 100/(110), 200/(220) VAC 6, 12, 24, 48, 100/110, 200/220 VDC
DC-switching	DP	MM2X	100/(110), 200/(220) VAC 6, 12, 24, 48, 100/110, 200/220 VDC
	3P	MM3X	100/(110), 200/(220) VAC 12, 24, 100/110 VDC
	4P	MM4X	100/(110), 200/(220) VAC 12, 24, 48, 100/110 VDC

Open Coils (with Screw Terminals)

Type	Contact form	Relay model	Available rated voltage
Standard	DP	MM2B	6, 12, 24, 50, 100/(110), 200/(220) VAC 12, 24, 48, 100/110, 125, 200/220 VDC
	3P	MM3B	6, 100/(110), 200/(220) VAC 12, 24, 100/110 VDC
	4P	MM4B	6, 100/(110), 200/(220) VAC 12, 24, 48, 100/110 VDC
DC-switching	DP	MM2XB	24, 100/(110), 200/(220) VAC 12, 24, 48, 100/110, 125, 200/220 VDC
	3P	MM3XB	100/(110), 200/(220) VAC 12, 24, 48, 100/110, 125, 200/220 VDC
	4P	MM4XB	12, 24, 100/(110), 200/(220) VAC 6, 12, 24, 48, 100/110, 200/220 VDC

Cased Coils (Plug-in Terminals)

Type	Contact form	Relay model	Available rated voltage
Standard	DP	MM2P	6, 12, 24, 50, 100/(110), 200/(220) VAC 6, 12, 24, 48, 100/110, 125, 200/220 VDC
	3P	MM3P	6, 24, 100/(110), 200/(220) VAC 6, 12, 24, 48, 100/110, 125, 200/220 VDC
	4P	MM4P	6, 24, 50, 100/(110), 200/(220) VAC 12, 24, 48, 100/110, 125, 200/220 VDC
DC-switching	DP	MM2XP	6, 24, 100/(110), 125, 200/(220) VAC 6, 12, 24, 48, 100/110, 125, 200/220 VDC
	3P	MM3XP	24, 50, 100/(110), 200/(220) VAC 12, 24, 48, 100/110, 125, 200/220 VDC
	4P	MM4XP	12, 24, 50, 100/(110), 200/(220) VAC 6, 12, 24, 48, 100/110, 125, 200/220 VDC
With built-in diode	DP	MM2P-D MM4P-D	12, 24, 48, 100/110, 200/220 VDC 12, 24, 48, 100/110, 125, 200/220 VDC
DC-switching with built-in diode	DP	MM2XP-D MM4XP-D	12, 24, 48, 100/110, 125, 200/220 VDC 12, 24, 48, 100/110, 125, 200/220 VDC
With operation indicator	DP	MM2PN	6, 24, 100/(110), 200/(220) VAC 6, 12, 24, 48, 100/110, 125, 200/220 VDC
	3P	MM3PN	100/(110), 200/(220) VAC 6, 12, 24, 48, 100/110, 200/220 VDC
	4P	MM4PN	24, 100/(110), 200/(220) VAC 24, 48, 100/110, 125, 200/220 VDC
DC-switching with operation indicator	DP	MM2XP-N	100/(110), 200/(220) VAC 12, 24, 48, 100/110, 125, 200/220 VDC
	3P	MM3XP-N	100/(110), 200/(220) VAC 24, 48, 100/110, 200/220 VDC
	4P	MM4XP-N	100/(110), 200/(220) VAC 12, 24, 48, 100/110, 125, 200/220 VDC
Conforming to auxiliary power relay specifications	4P	MM4P-JD	100/(110), 110, 115, 200/(220), 220 VAC 24, 100/110, 125, 200/220 VDC
Conforming to auxiliary power relay specifications for DC-switching	4P	MM4XP-JD	100/(110), 110, 115, 200/(220) VAC 24, 48, 100/110, 125, 200/220 VDC

Models Conforming to Auxiliary Power Relay Specifications

The MM4P-JD and MM4XP-JD satisfy the ratings of auxiliary relays provided in JEC-2500 (1987) standards for power protective relays specified by the Japan Electromechanical Commission. Furthermore, the MM4P-JD and MM4XP-JD satisfy the ratings of multi-contact relays provided in JEC-174D (1979) standards for power auxiliary relays.

These models work at operation level B specified by JEC-174D (1979) standards and the hot start of the relays is possible after the coils radiate heat.

In accordance with JEC-2500 (1987) standards, the coil of each model withstands a 130% DC load or 115% AC load.

Note: 1. When ordering, add the rated coil voltage to the model number. Rated coil voltages are given in the coil ratings table.

Example: MM2, 6 VAC

Rated coil voltage

- Latching Relays based on the MM Series are also available. Refer to the MMK.
- Models with built-in varistors (AC operation) are also available in addition to those with built-in diodes. Ask your OMRON representative for details.

Model Number Legend

MM□□□□-□
 1 2 3 4 5

1. Contact Form

- 2: DPDT
- 3: 3PDT
- 4: 4PDT

2. Type (See Note.)

- None: Standard
- X: DC-switching

3. Terminal Shape

- None: Solder
- B: Screw
- P: Plug-in

4. Operation Indicator

- None: Not provided
- N: Provided

5. Built-in Diode

- None: Not provided
- D: Provided



Note: The suffix "JD" indicates models conforming to auxiliary power relay specifications.

■ Accessories (Order Separately)

Mounting Brackets

Mounting Bracket (S bracket)	R99-03MM
------------------------------	----------

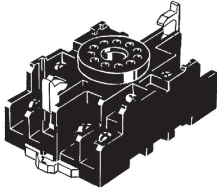
Sockets

Relay model	DIN Track/Front-connecting Socket (screw terminals)	Back-connecting Socket (solder terminals)
MM2(X)P(-D)	8PFA	PL08
MM3P	11PFA 	PL11 
MM3XP, MM4(X)P(-D)	14PFA	PL15
MM4(X)P-JD	14PFA	---

Specifications

■ Coil Ratings

Open Coils (with Solder or Screw Terminals)

	Rated voltage (V)	Rated current (mA)				Coil resistance (Ω)		Must-operate voltage	Must-release voltage	Max. voltage	Power consumption (VA or W)		
		DP		3P or 4P		DP	3P or 4P				% of rated voltage	Initial	Rated
		50 Hz	60 Hz	50 Hz	60 Hz								
AC	6	790	655	1,120	950	1.1	0.5	80% max.	30% min. (60 Hz) 25% min. (50 Hz)	110%	Approx. 4.1 (DP) Approx. 6.3 (3P or 4P)	Approx. 3.5 (DP) Approx. 5.1 (3P or 4P)	
	12	395	325	560	480	4.7	2.0						
	24	195	160	280	240	19	8.5						
	50	94	78	134	114	82	36						
	100/(110)	47	39/45	67	57/66	340	150						
	200/(220)	23.5	19.5/ 22.5	33.5	28.5/33	1,540	620						
DC	6	340		450		17.5	13.4	70% max.	10% min.		Approx. 2.1 (DP) Approx. 2.7 (3P or 4P)		
	12	176		220		68	54						
	24	87		94		275	255						
	48	41		52		1,180	930						
	100/110	17/19		22/24.5		5,750	4,500						
	200/220	8.6/9.5		11/12		23,200	18,000						

- Note:**
1. The rated current and coil resistance are measured at a coil temperature of 23°C with tolerances of +15%/–20% for AC rated current and ±15% for DC coil resistance.
 2. The AC coil resistance values are reference values.
 3. Performance characteristic data are measured at a coil temperature of 23°C.
 4. The maximum voltage is one that is applicable instantaneously to the Relay coil at an ambient temperature of 23°C and not continuously.

Cased Coils (Plug-in Terminals)

The rated current may vary if the Relay has a built-in operating indicator (See note 4.).

	Rated voltage (V)	Rated current (mA)				Coil resistance (Ω)		Coil inductance (H)				Must-operate voltage	Must-release voltage	Max. voltage	Power consumption (VA or W)		
		DP		3P or 4P		DP	3P or 4P	DP		3P or 4P					% of rated voltage	Initial	Rated
		50 Hz	60 Hz	50 Hz	60 Hz			Contact release	Contact operate	Contact release	Contact operate						
AC	6	690	590	975	850	1.1	0.5	0.02	0.02	0.01	0.03	80% max.	30% min. (60 Hz) 25% min. (50 Hz)	110%	Ap- prox. 4.1 (DP) Ap- prox. 6.3 (3P or 4P)	Ap- prox. 3.5 (DP) Ap- prox. 5.1 (3P or 4P)	
	12	345	295	490	430	4.7	2.0	0.07	0.01	0.04	0.07						
	24	170	145	245	210	19	8.5	0.28	0.41	0.18	0.28						
	50	82	70	117	102	82	36	1.2	1.7	0.75	1.2						
	100/(110)	41	35/40	58.5	51/58	340	150	4.8	6.7	3	4.5						
	200/(220)	20.5	17.5/ 20	29	25.5/ 29	1,540	620	20	25.6	12	19						
DC	6	340		450		17.5	13.4	0.2	0.36	0.23	0.35	70% max.	10% min.		Approx. 2.1 (DP) Approx. 2.7 (3P or 4P)		
	12	176		220		68	54	0.74	1.0	0.87	1.4						
	24	87		94		275	255	4.2	5.8	5.6	9.2						
	48	41		52		1,180	930	20.4	26	27.3	45.5						
	100/110	17/19		22/24.5		5,750	4,500	81.6	92.5	61.4	96.5						
	200/220	8.6/9.5		11/12		23,200	18,000	340	380	158	250						

- Note:**
1. The rated current and coil resistance are measured at a coil temperature of 23°C with tolerances of +15%/–20% for AC rated current and ±15% for DC coil resistance.
 2. The AC coil resistance and coil inductance values are for reference only.
 3. Performance characteristic data are measured at a coil temperature of 23°C.
 4. The maximum voltage is one that is applicable instantaneously to the Relay coil at an ambient temperature of 23°C and not continuously.
 5. The rated current of a model with a built-in LED indicator at 6, 12, 24, or 50 VAC or 6, 12, 24, or 48 VDC increases by approx. 10 mA due to the current consumption of the LED. The rated current of a model with a built-in neon lamp indicator at 100/(110) or 200/(220) VAC or 100/110 or 200/220 VDC increases by approx. 0.2 mA due to the current consumption of the neon lamp.

Coils (Conforming to Auxiliary Power Relay Specifications)

	Rated voltage (V)	Rated current (mA)		Coil resistance (Ω)	Coil inductance (H)		Must-operate voltage	Must-release voltage	Max. voltage	Operation level (JEC-174D)	Power consumption (VA or W)	
		50 Hz	60 Hz		Contact release	Contact operate					% of rated voltage	Initial
AC	24	245	210	8.5	0.18	0.28	80% max.	30% min. (60 Hz) 25% min. (50 Hz)	110%	B Hot start after coil heated	Approx. 6.3	Approx. 5.1
	50	117	102	36	0.75	1.2						
	100/(110)	58.5	51/58	150	3	4.5						
	110	53	46	182	3.6	5.5						
	115	51	44	210	4	6.2						
	200/(220)	29	25.5/29	620	12	19						
	220	26.5	23	780	15	21						
DC	24	94		255	5.6	9.2	70% max.	10% min.			Approx. 2.7	
	48	52		930	27.3	45.5						
	100/110	22/24.5		4,500	61.4	96.5						
	125	22		5,800	90	130						
	200/220	11/12		18,000	158	250						

- Note:**
- The rated current and coil resistance are measured at a coil temperature of 23°C with tolerances of +15%/–20% for AC rated current and \pm 15% for DC coil resistance.
 - The AC coil resistance and coil inductance values are for reference only.
 - Performance characteristic data are measured at a coil temperature of 23°C.
 - The maximum voltage is one that is applicable instantaneously to the Relay coil at 23°C and not continuously.

Contact Ratings

Standard Relays

Item	Open Relays		Cased Relays	
	MM2(B), MM3(B), MM4(B)		MM2P(N, -D), MM3P(N), MM4P(N, -D)	
	Resistive load ($\cos\phi = 1$)	Inductive load ($\cos\phi=0.4$, L/R=7 ms)	Resistive load ($\cos\phi = 1$)	Inductive load ($\cos\phi=0.4$, L/R=7 ms)
Contact type	Single			
Contact material	Ag			
Rated load	15 A at 220 VAC 10 A at 24 VDC		7.5 A at 220 VAC 5 A at 24 VDC	
Rated carry current	15 A		7.5 A	
Max. switching voltage	250 VAC, 250 VDC		250 VAC, 250 VDC	
Max. switching current	15 A		7.5 A	
Max. switching power (reference value)	3,300 VA at 240 W		1,700 VA at 120 W	
Minimum permissible load (reference value) (See note.)	5 VDC 10 mA			

Note: This value is measured at 60 operations/min.

DC-switching Relays/Built-in Diode Relays

Item	Open Relays		Cased Relays	
	MM2X(B), MM3X(B), MM4X(B)		MM2XP(-D), MM3XP, MM4XP(-D)	
	Resistive load ($\cos\phi = 1$)	Inductive load (L/R=7 ms)	Resistive load ($\cos\phi = 1$)	Inductive load (L/R=7 ms)
Contact type	Single			
Contact material	Ag			
Rated load	10 A at 110 VDC	7 A at 110 VDC	7 A at 110 VDC	6 A at 110 VDC
Rated carry current	15 A		7.5 A	
Max. switching voltage	250 VAC, 250 VDC		250 VAC, 250 VDC	
Max. switching current	15 A		7.5 A	
Max. switching power (reference value)	1,200 W at 20 VA *1	800 W at 20 VA *1	800 W at 20 VA *1	660 W at 20 VA *1
Minimum permissible load (reference value) *2	5 VDC at 10 mA			

- Note:**
- When switching DC inductive loads at 125 V or more, an unstable region exists for a contact current of between 0.5 and 2.5 A. The Relay will not turn OFF in this region. Use a contact current of 0.5 A or less when switching 125 VDC or more.
 - If L/R exceeds 7 ms when switching DC inductive loads, an arc-breaking time of up to 50 ms must be considered in application and the circuit must be designed to ensure that an arc-breaking time of 50 ms is not exceeded.
 - The switching capacity for an AC load is minute.
 - *1. Refer to *Switching an AC Load with a DC-switching Model ("X" Model)* on page 16.
 - *2. This value is measured at 60 operations/min.

Contacts (Conforming to Auxiliary Power Relay Specifications)

Item	MM4P-JD		MM4XP-JD	
	Resistive load	Inductive load ($\cos\phi = 0.4$, L/R = 7 ms)	Resistive load	Inductive load ($\cos\phi = 0.4$, L/R = 7 ms)
Contact type	Single			
Contact material	Ag			
Rated load	5 A at 220 VAC, 5 A at 24 VDC		5 A at 110 VDC	
Rated carry current	5 A			
Max. switching voltage	250 VAC, 250 VDC			
Max. switching current	5 A			
Max. switching power (reference value)	1,100 VA, 120 W, 30 W (L/R = 40 ms)		20 VA, 550 W, 40 W (L/R = 40 ms)	

Note: 1. A model for DC loads is not in stable operation when switching an inductive load within a operating current range between 0.5 and 2.5 A at a minimum of 125 VDC, where the load cannot be switched.

2. If L/R exceeds 7 ms when switching DC inductive loads, an arc-breaking time of up to 50 ms must be considered in application and the circuit must be designed to ensure that an arc-breaking time of 50 ms is not exceeded.

■ Characteristics

Standard Relays

Item	Open Relays	Cased Relays
Contact resistance (See note 2.)	25 mΩ max.	50 mΩ max.
Operate time (See note 3.)	AC: 25 ms max. DC: 50 ms max.	
Release time (See note 3.)	30 ms max. (100 ms max. for Built-in Diode Relays)	
Max. operating frequency	Mechanical: 7,200 operations/hr Electrical: 1,800 operations/hr (under rated load)	
Insulation resistance (See note 4.)	100 MΩ min. (at 500 VDC)	
Dielectric strength	1,500 VAC, 50/60 Hz for 1 min between contacts of same polarity 2,000 VAC, 50/60 Hz for 1 min between contacts of different polarity (and between coil and contacts)	
Vibration resistance	Destruction: 10 to 55 to 10 Hz, 0.75 mm single amplitude (1.5 mm double amplitude) Malfunction: 10 to 55 to 10 Hz, 0.5 mm single amplitude (1.0 mm double amplitude)	
Shock resistance	Destruction: 1,000 m/s ² Malfunction: 100 m/s ²	
Endurance	Mechanical: 5,000,000 operations min. (at 7,200 operations/hr) Electrical: 500,000 operations min. (at 1,800 operations/hr under rated load) (See note 5.)	
Ambient temperature	Operating: -10°C to 55°C (with no icing or condensation)	
Ambient humidity	Operating: 5% to 85%	
Weight	Standard models: DC-switching models MM2 approx. 160 g MM2X approx. 165 g MM2XP approx. 225 g MM3 approx. 270 g MM3X approx. 275 g MM3XP approx. 395 g MM4 approx. 300 g MM4X approx. 310 g MM4XP approx. 420 g MM2P approx. 220 g MM3P approx. 360 g MM4P approx. 410 g	

Note: 1. The data shown above are initial values.

2. The contact resistance was measured with 1 A at 5 VDC using the voltage drop method.

3. The operate or release time was measured with the rated voltage imposed with any contact bounce ignored at an ambient temperature of 23°C.

4. The insulation resistance was measured with a 500-VDC megger applied to the same places as those used for checking the dielectric strength.

5. The electrical endurance was measured at an ambient temperature of 23°C.

Relays (Conforming to Auxiliary Power Relay Specifications)

Item	Cased Relays
Contact resistance (See note 2.)	50 mΩ max.
Operate time (See note 3.)	AC: 25 ms max., DC: 50 ms max.
Release time (See note 3.)	30 ms max.
Max. operating frequency	Mechanical: 1,800 operations/hr Electrical: 1,800 operations/hr (under rated load)
Insulation resistance (See note 4.)	100 MΩ min.
Dielectric strength	Between coil and contact: 2,000 VAC, 50/60 Hz for 1 minute Between contacts of different polarity: 2,000 VAC, 50/60 Hz for 1 minute Between contacts of same polarity: 1,500 VAC, 50/60 Hz for 1 minute
Vibration resistance	Destruction: 10 to 55 to 10 Hz, 0.75 mm single amplitude (1.5 mm double amplitude) Malfunction: 10 to 22 to 10 Hz, 0.5 mm single amplitude (1.0 mm double amplitude)
Shock resistance	Destruction: 300 m/s ² Malfunction: 30 m/s ²
Endurance	Mechanical: 5,000,000 operations min. (at 1,800 operations/hr) Electrical: 500,000 operations min. (at 1,800 operations/hr with rated load) (see note 5)
Error rate (level P) (Reference value) (See note 6.)	10 mA at 5 VDC
Ambient temperature	Operating: -10°C to 40°C (with no icing or condensation)
Ambient humidity	Operating: 5% to 85%
Weight	MM4P-JD: approx. 410 g MM4XP-JD: approx. 420 g

- Note:**
- The data shown above are initial values.
 - The contact resistance was measured with 1 A at 5 VDC using the voltage drop method.
 - The operate or release time was measured with the rated voltage imposed with any contact bounce ignored at an ambient temperature of 23°C.
 - The insulation resistance was measured with a 500-VDC megger applied to the same places as those used for checking the dielectric strength.
 - The electrical endurance was measured at an ambient temperature of 23°C.
 - This value was measured at a switching frequency of 60 operations per minute.

Engineering Data

Standard Relays

Maximum Switching Power Open Relays

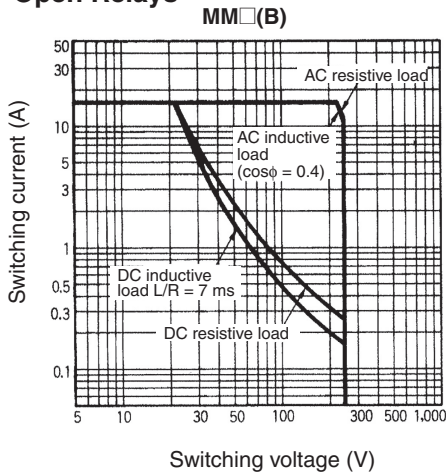

Cased Relays MM□P(N, -D)

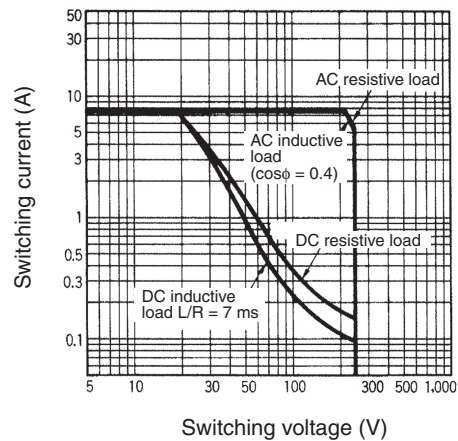

Endurance Curves

Open Relays

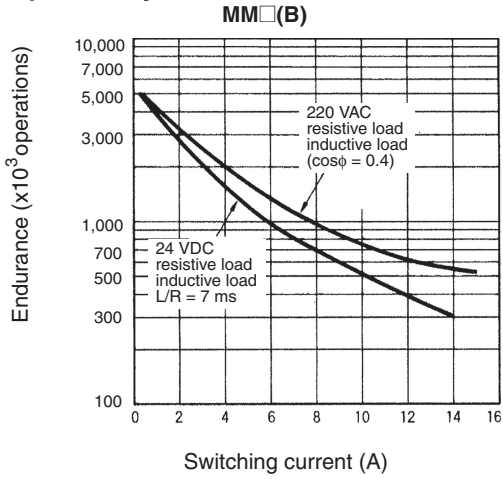

Cased Relays

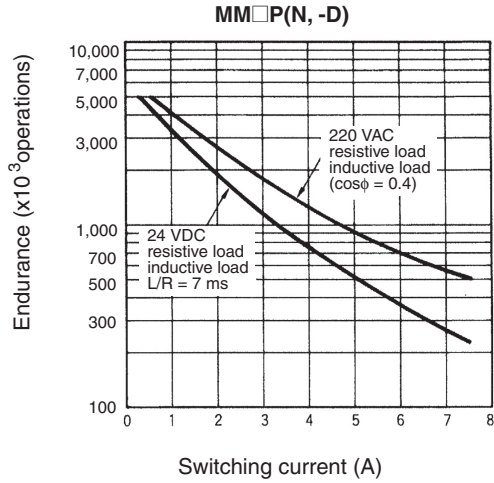

DC-switching Relays

**Maximum Switching Power
Open Relays**

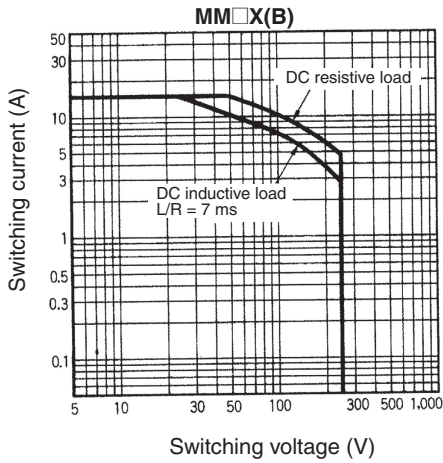

Cased Relays

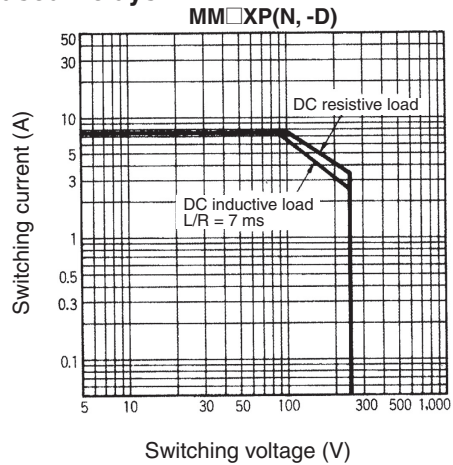

Endurance Curves

Open Relays

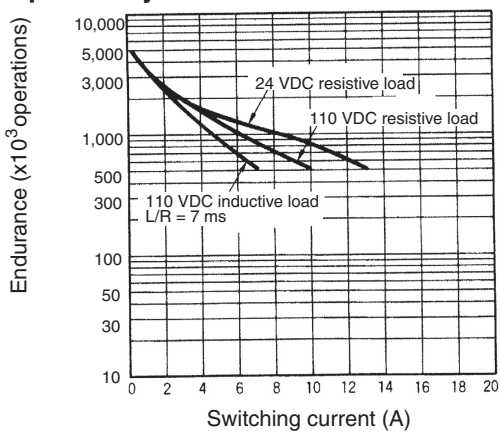

Cased Relays

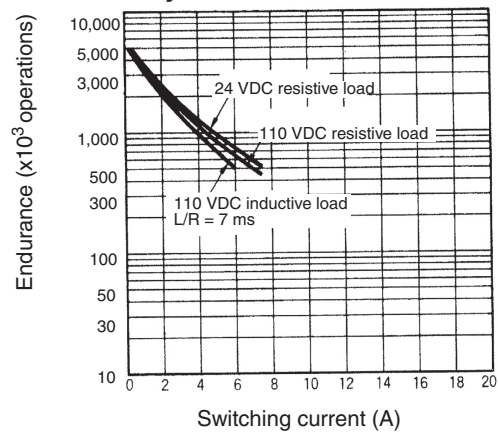

Relays Conforming to Auxiliary Power Relay Specifications

Maximum Switching Power

MM4P-JD

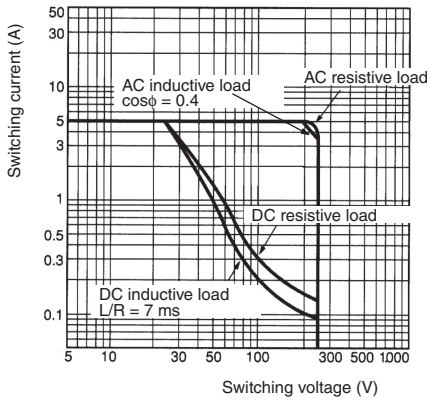

MM4XP-JD

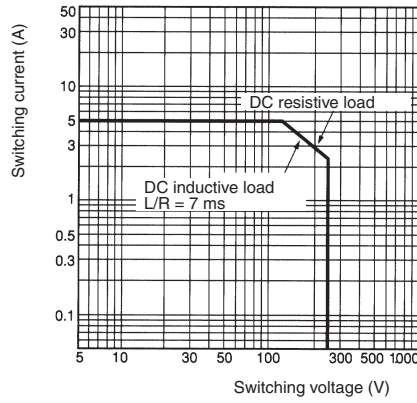

Endurance Curves

MM4P-JD

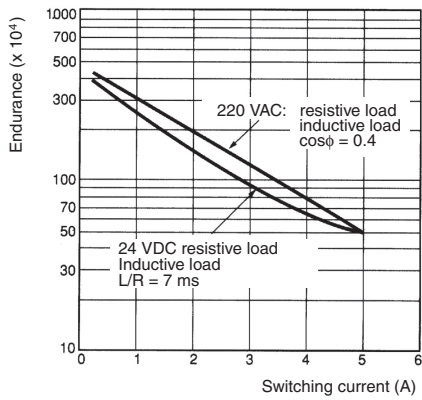

MM4XP-JD

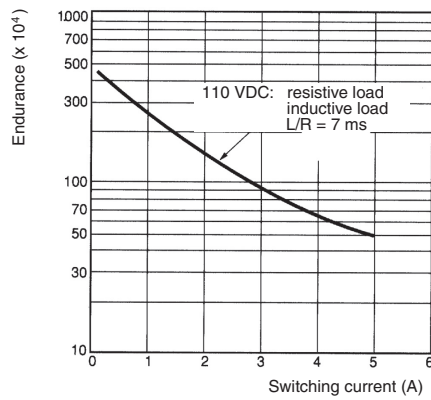

Ambient Temperature vs. Must-operate and Must-release Voltage

MM2P AC (60 Hz)

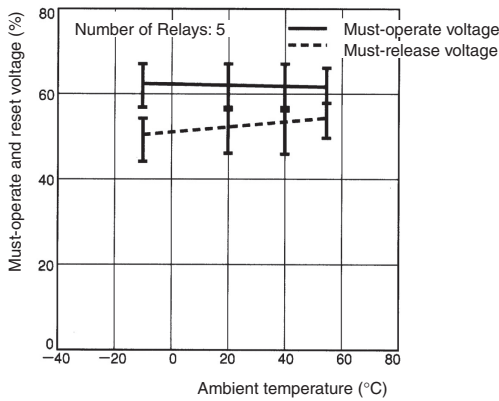

MM2P DC

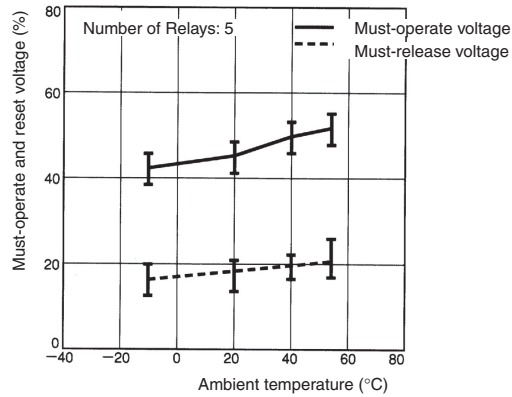

Ambient Temperature vs. Coil Temperature Rise

MM2P 110 VAC (60 Hz)

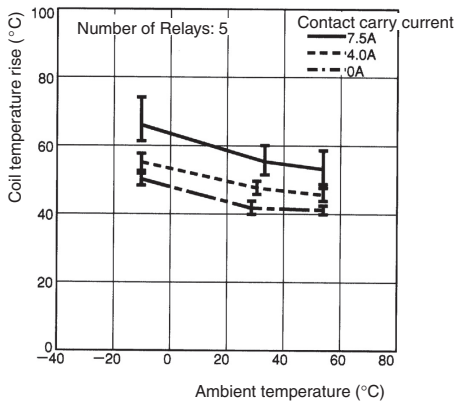

MM2P DC

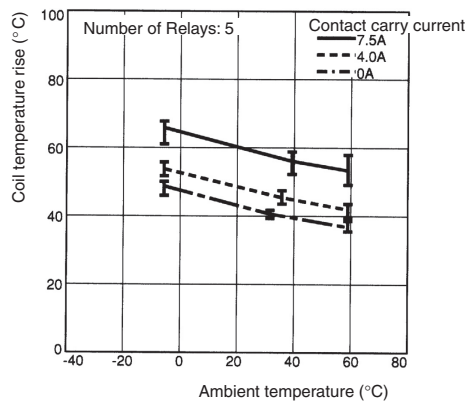

Malfunctioning Shock

MM2P AC

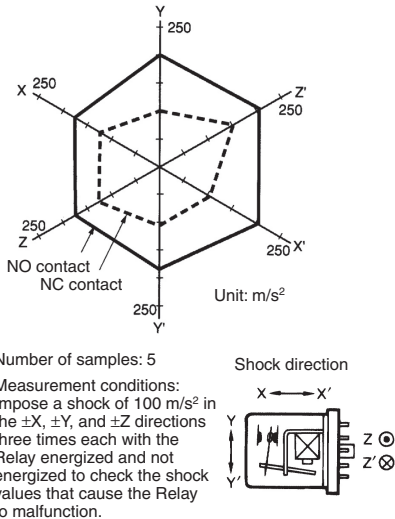

Contact Reliability

(Improved Allen-Bradley Test Circuit)

MM4P 24 VDC

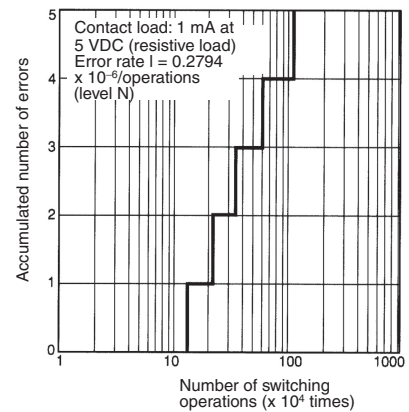
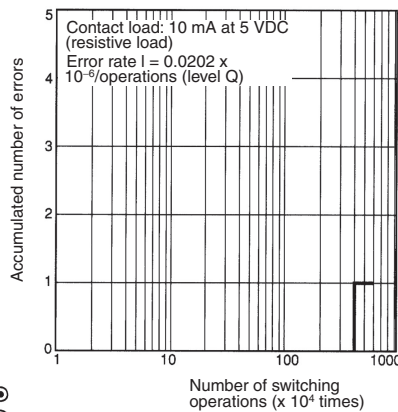

Relay Mounting Adjacent Distance vs. Coil Temperature Rise

MM4P 100 / (110) VAC

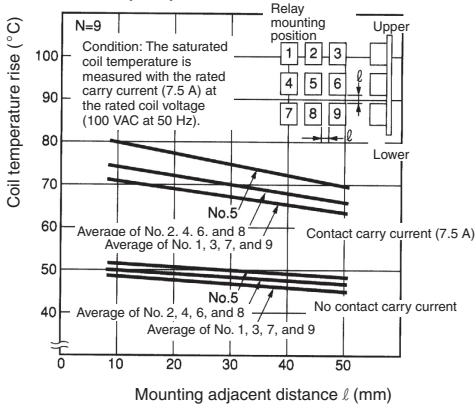

Dimensions

Note: All units are in millimeters unless otherwise indicated.

Standard Relays

Open Relays

Solder Terminals

MM2(X), MM4(X), MM3(X)

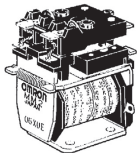

MM2

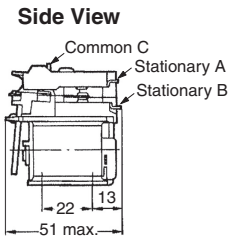
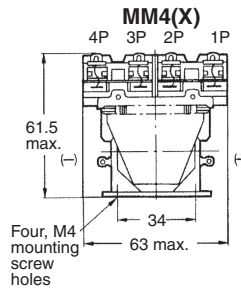
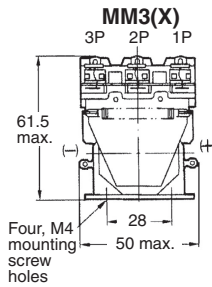
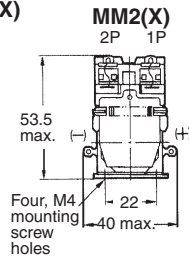

Note: Connect the common (C) of MM□X to positive (+).

Screw Terminals

MM2(X)B, MM3(X)B, MM4(X)B

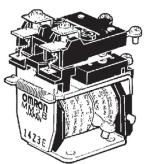

MM2B

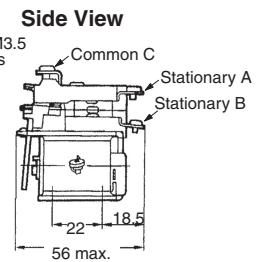
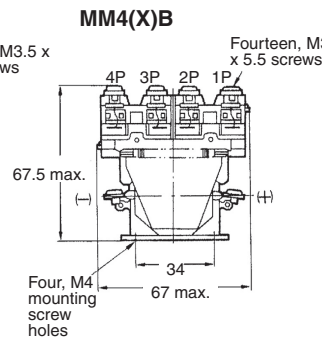
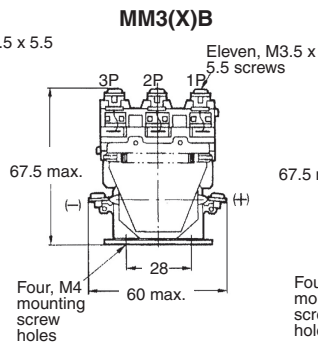
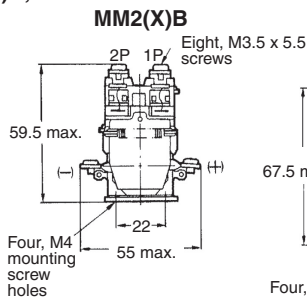

Note: Connect the common (C) of MM□XB to positive (+).

**Mounting Holes
(Bottom View)**

Direct mounting

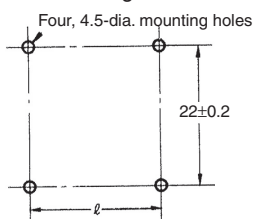

Length of ℓ
 DPDT: 22 ± 0.2
 3PDT: 28 ± 0.2
 4PDT: 34 ± 0.2

**Mounting Bracket (S Bracket)
R99-03 (S KANAGU) FOR MM□**

The S Bracket can be used to mount a Relay with open solder or screw terminals.

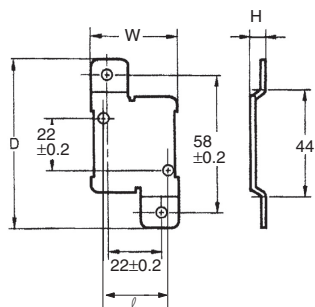
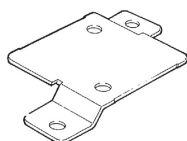

	R99-03 (S KANAGU) FOR MM2 (611) (DPDT)	R99-03 (S KANAGU) FOR MM3.4 (61) 3PDT, 4PDT
ℓ	22	28, 34
D	71 max.	71 max.
W	36 max.	46 max.
H	6 max.	6 max.

Cased Relays

Plug-in Terminals

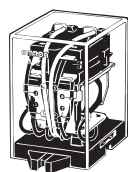

MM2P(N, -D)
MM2XP(N, -D)

MM2P

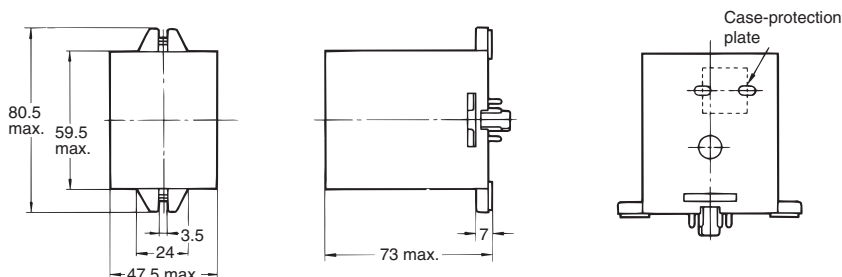

Note: As shown in the diagram, there are three 10-dia. holes in the side of the case for the MM2XP(N, -D).
When a case-protection plate is attached, the width of the Relay will be 48 mm max.

Terminal Arrangement (Bottom View)

Make sure that all common connections have the same polarity for the MM2XP-N/-D. The markings of the common connections on the casing all show "+" but the polarity of the common connections can be either negative or positive as long as they are all the same.

MM2P	MM2P-D	MM2PN	MM2PN	MM2PN
		6, 12, 24, 50 VAC 	6, 12, 24, 48 VDC 	100/(110), 200/(220) VAC 100/110, 200/220 VDC
MM2XP	MM2XP-D	MM2XPN	MM2XPN	MM2XPN
		6, 12, 24, 50 VAC 	6, 12, 24, 48 VDC 	100/(110), 200/(220) VAC 100/110, 200/220 VDC

Note: Wire the terminals correctly with no mistakes in coil polarity.

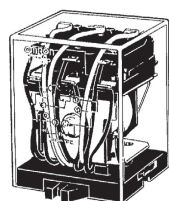

MM3P(N)

MM3P

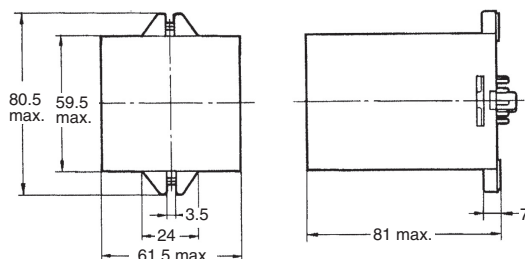

Terminal Arrangement (Bottom View)

MM3P	MM3PN	MM3PN	MM3PN
	6, 12, 24, 50 VAC 	6, 12, 24, 48 VDC 	100/(110), 200/(220) VAC 100/110, 200/220 VDC

Note: Wire the terminals correctly with no mistakes in coil polarity.

MM3XP(N)
MM4P(N, -D)
MM4XP(N, -D)

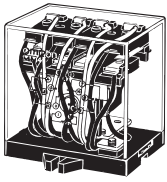

MM4P

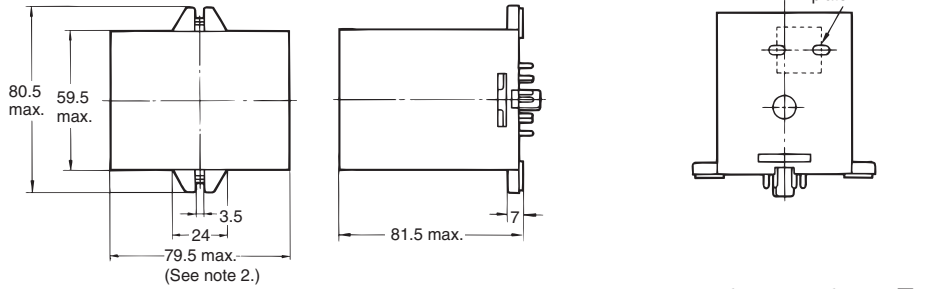

Note 1: As shown in the diagram, there are three 10-dia. holes in the side of the case for MM□XP(N, -D).
Note 2: When a case-protection plate is attached, the width of the Relay will be 80 mm max.

Terminal Arrangement (Bottom View)

Make sure that all common connections have the same polarity for the MM□XP-N/-D. The markings of the common connections on the casing all show "+" but the polarity of the common connections can be either negative or positive as long as they are all the same.

<p>MM3XP</p>	<p>MM3XPN 6, 12, 24, 50 VAC</p>	<p>MM3XPN 6, 12, 24, 48 VDC</p>	<p>MM3XPN 100/(110), 200/(220) VAC 100/110, 200/220 VDC</p>	
<p>MM4P</p>	<p>MM4P-D</p>	<p>MM4PN 6, 12, 24, 50 VAC</p>	<p>MM4PN 6, 12, 24, 48 VDC</p>	<p>MM4PN 100/(110), 200/(220) VAC 100/110, 200/220 VDC</p>
<p>MM4XP</p>	<p>MM4XP-D</p>	<p>MM4XPN 6, 12, 24, 50 VAC</p>	<p>MM4XPN 6, 12, 24, 48 VDC</p>	<p>MM4XPN 100/(110), 200/(220) VAC 100/110, 200/220 VDC</p>

Note: Wire the terminals correctly with no mistakes in coil polarity.

MM4P-JD

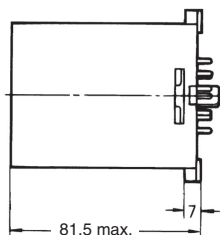
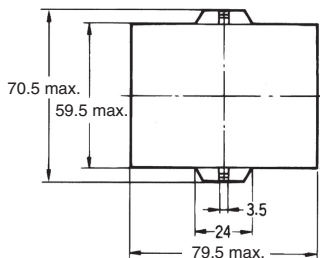
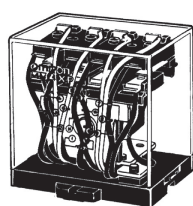

Terminal Arrangement (Bottom View)

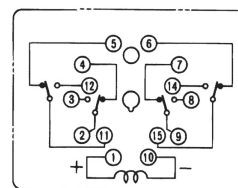

MM4XP-JD

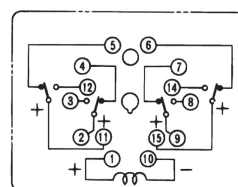
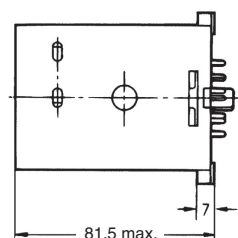
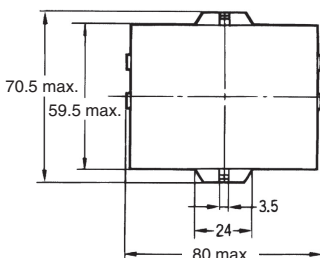
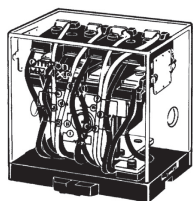

Note: Make sure that all common connections are the same in polarity. The markings of the common connections on the casing all show "+" but the polarity of the common connections can be either all negative or all positive.

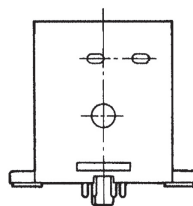

■ Relays with Operation Indicators

Dimensions are the same as those for standard Relays except that there are three 10-mm holes in the case as shown below.

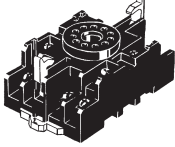

Accessories

■ Sockets

Relay model	DIN Track/Front-connecting Socket (screw terminals)	Back-connecting Socket (solder terminals)
MM2(X)P(-D)	8PFA	PL08
MM3P	11PFA 	PL11 
MM3XP, MM4(X)P(N)(-D)	14PFA	PL15
MM4(X)P-JD	14PFA	---

Note: When using the MM4(X)P-JD (i.e., a model conforming to auxiliary power relay specifications) by itself, the PL15 Back-connecting Socket cannot be used.

Height with Socket

DIN Track/Front-connecting Socket

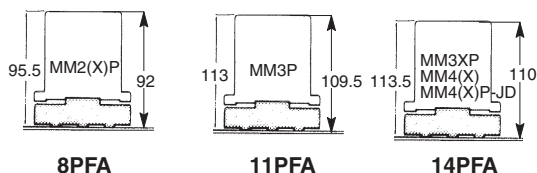

Back-connecting Socket

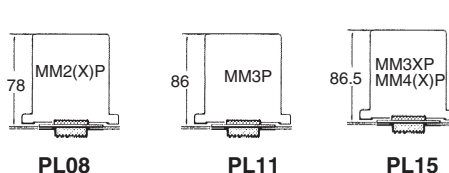

Safety Precautions

Refer to *Safety Precautions for All Relays*.

■ Connection

- Use proper crimp terminals or 1.2- to 2-mm-dia. single-conductor wire to connect screw terminals.
- Connect loads to DC-switching Relays so that arcs from adjacent terminals will not strike each other. E.g., connect all common terminals to the same polarity.
- Screw Terminal Model:
Do not bend the coil terminals, otherwise the coil wire may be disconnected. Make sure that the tightening torque applied to each terminal is 0.78 to 1.18 N·m and the insertion force is 49 N for 10 s.
- Do not reverse polarity when connecting open DC-switching Relays, including 3- and 4-pole models.

■ Installation

- Do not install the Relays where iron dust can adhere to the contacts or coil. Such dust can prevent the armature from moving freely and inhibit proper electrical contact.
- Relays can generate arcs externally. Either install the Relay in a location where a nearby object will not burn or use a covered Relay.
- DC-switching Relays contain a permanent magnet in the insulation base. Do not place a magnet or magnetic object near this base. Doing so will reduce the power of the permanent magnet, thus reducing Relay capacity.
- Insert PL Back-mounting Sockets from the back of the panel.
- To minimize the influence of heat, separate Relays from each other by at least 20 mm for cooling when mounting multiple Relays together.

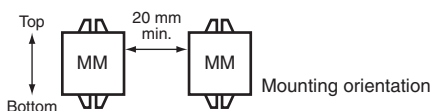

- Relays should be mounted with the armature facing down.

■ Wiring

When connecting a load to the contact terminals of a model for DC loads, consider the polarity of the contact terminals so that the generated arcs on the adjacent poles will not collide. If the common connections of the Relay are all positive or all negative, no arc collision will occur.

■ MMXP

The MMXP has a hole in the Relay case to allow gas to escape. Do not use this Relay in locations subject to excessive dust.

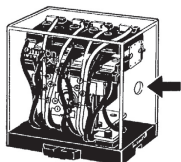

■ Contact Loads

The contact load should be greater than the power consumption of the coil. If it is less than this power consumption or if the Relay is operated very infrequently, the contact can change chemically thus causing unstable operation.

■ Soldering

When soldering solder terminals, do not let flux or other foreign matter adhere to contacts or do not let the coil terminals become bent. Also, solder as quickly as possible because excessive heat may damage the coil.

■ Diode Built into Relays

A diode is built into the Relays to absorb reverse electromotive force from the relay coil. The diode will be destroyed if a large external surge voltage is applied. If there is a possibility of a large external surge voltage being applied, take suitable measures to absorb the surge.

■ Storage

A model for DC loads incorporates a permanent magnetic for arc suppression. Keep floppy disks away from the Relay, otherwise the data on the floppy disk may be damaged.

■ Operating Environment

Do not use the Relay in places with flammable gas, otherwise an explosion may result due to an arc generated from the Relay

■ Switching an AC Load with a DC-switching Model (“X” Model)

DC-switching Relays (“X” models) use a magnet to extinguish arcs. The polarity must be correct when you connect the switching section. However, if you connect an AC load, the positive and negative poles of the power supply alternate. This can cause short-circuits due to the collision of arcs that occur when the Relay turns OFF. Therefore, the switching capacity for an AC load is specified as 20 VA or less to prevent short circuits caused by arc collisions. Take sufficient caution if you switch an AC Load with a DC-switching model (“X” models).

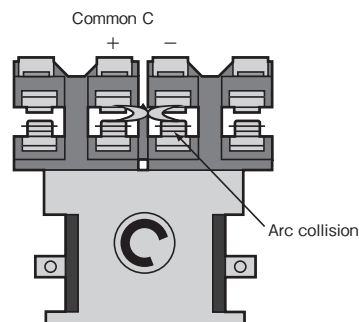

■ Refer to the technical guide on your OMRON website for technical descriptions and FAQs on the product.

ALL DIMENSIONS SHOWN ARE IN MILLIMETERS.

To convert millimeters into inches, multiply by 0.03937. To convert grams into ounces, multiply by 0.03527.

In the interest of product improvement, specifications are subject to change without notice.

Terms and Conditions Agreement

Read and understand this catalog.

Please read and understand this catalog before purchasing the products. Please consult your OMRON representative if you have any questions or comments.

Warranties.

(a) Exclusive Warranty. Omron's exclusive warranty is that the Products will be free from defects in materials and workmanship for a period of twelve months from the date of sale by Omron (or such other period expressed in writing by Omron). Omron disclaims all other warranties, express or implied.

(b) Limitations. OMRON MAKES NO WARRANTY OR REPRESENTATION, EXPRESS OR IMPLIED, ABOUT NON-INFRINGEMENT, MERCHANTABILITY OR FITNESS FOR A PARTICULAR PURPOSE OF THE PRODUCTS. BUYER ACKNOWLEDGES THAT IT ALONE HAS DETERMINED THAT THE PRODUCTS WILL SUITABLY MEET THE REQUIREMENTS OF THEIR INTENDED USE.

Omron further disclaims all warranties and responsibility of any type for claims or expenses based on infringement by the Products or otherwise of any intellectual property right. (c) Buyer Remedy. Omron's sole obligation hereunder shall be, at Omron's election, to (i) replace (in the form originally shipped with Buyer responsible for labor charges for removal or replacement thereof) the non-complying Product, (ii) repair the non-complying Product, or (iii) repay or credit Buyer an amount equal to the purchase price of the non-complying Product; provided that in no event shall Omron be responsible for warranty, repair, indemnity or any other claims or expenses regarding the Products unless Omron's analysis confirms that the Products were properly handled, stored, installed and maintained and not subject to contamination, abuse, misuse or inappropriate modification. Return of any Products by Buyer must be approved in writing by Omron before shipment. Omron Companies shall not be liable for the suitability or unsuitability or the results from the use of Products in combination with any electrical or electronic components, circuits, system assemblies or any other materials or substances or environments. Any advice, recommendations or information given orally or in writing, are not to be construed as an amendment or addition to the above warranty.

See <http://www.omron.com/global/> or contact your Omron representative for published information.

Limitation on Liability; Etc.

OMRON COMPANIES SHALL NOT BE LIABLE FOR SPECIAL, INDIRECT, INCIDENTAL, OR CONSEQUENTIAL DAMAGES, LOSS OF PROFITS OR PRODUCTION OR COMMERCIAL LOSS IN ANY WAY CONNECTED WITH THE PRODUCTS, WHETHER SUCH CLAIM IS BASED IN CONTRACT, WARRANTY, NEGLIGENCE OR STRICT LIABILITY.

Further, in no event shall liability of Omron Companies exceed the individual price of the Product on which liability is asserted.

Suitability of Use.

Omron Companies shall not be responsible for conformity with any standards, codes or regulations which apply to the combination of the Product in the Buyer's application or use of the Product. At Buyer's request, Omron will provide applicable third party certification documents identifying ratings and limitations of use which apply to the Product. This information by itself is not sufficient for a complete determination of the suitability of the Product in combination with the end product, machine, system, or other application or use. Buyer shall be solely responsible for determining appropriateness of the particular Product with respect to Buyer's application, product or system. Buyer shall take application responsibility in all cases.

NEVER USE THE PRODUCT FOR AN APPLICATION INVOLVING SERIOUS RISK TO LIFE OR PROPERTY OR IN LARGE QUANTITIES WITHOUT ENSURING THAT THE SYSTEM AS A WHOLE HAS BEEN DESIGNED TO ADDRESS THE RISKS, AND THAT THE OMRON PRODUCT(S) IS PROPERLY RATED AND INSTALLED FOR THE INTENDED USE WITHIN THE OVERALL EQUIPMENT OR SYSTEM.

Programmable Products.

Omron Companies shall not be responsible for the user's programming of a programmable Product, or any consequence thereof.

Performance Data.

Data presented in Omron Company websites, catalogs and other materials is provided as a guide for the user in determining suitability and does not constitute a warranty. It may represent the result of Omron's test conditions, and the user must correlate it to actual application requirements. Actual performance is subject to the Omron's Warranty and Limitations of Liability.

Change in Specifications.

Product specifications and accessories may be changed at any time based on improvements and other reasons. It is our practice to change part numbers when published ratings or features are changed, or when significant construction changes are made. However, some specifications of the Product may be changed without any notice. When in doubt, special part numbers may be assigned to fix or establish key specifications for your application. Please consult with your Omron's representative at any time to confirm actual specifications of purchased Product.

Errors and Omissions.

Information presented by Omron Companies has been checked and is believed to be accurate; however, no responsibility is assumed for clerical, typographical or proofreading errors or omissions.



Компания «ЭлектроПласт» предлагает заключение долгосрочных отношений при поставках импортных электронных компонентов на взаимовыгодных условиях!

Наши преимущества:

- Оперативные поставки широкого спектра электронных компонентов отечественного и импортного производства напрямую от производителей и с крупнейших мировых складов;
- Поставка более 17-ти миллионов наименований электронных компонентов;
- Поставка сложных, дефицитных, либо снятых с производства позиций;
- Оперативные сроки поставки под заказ (от 5 рабочих дней);
- Экспресс доставка в любую точку России;
- Техническая поддержка проекта, помощь в подборе аналогов, поставка прототипов;
- Система менеджмента качества сертифицирована по Международному стандарту ISO 9001;
- Лицензия ФСБ на осуществление работ с использованием сведений, составляющих государственную тайну;
- Поставка специализированных компонентов (Xilinx, Altera, Analog Devices, Intersil, Interpoint, Microsemi, Aeroflex, Peregrine, Syfer, Eurofarad, Texas Instrument, Miteq, Cobham, E2V, MA-COM, Hittite, Mini-Circuits, General Dynamics и др.);

Помимо этого, одним из направлений компании «ЭлектроПласт» является направление «Источники питания». Мы предлагаем Вам помощь Конструкторского отдела:

- Подбор оптимального решения, техническое обоснование при выборе компонента;
- Подбор аналогов;
- Консультации по применению компонента;
- Поставка образцов и прототипов;
- Техническая поддержка проекта;
- Защита от снятия компонента с производства.



Как с нами связаться

Телефон: 8 (812) 309 58 32 (многоканальный)

Факс: 8 (812) 320-02-42

Электронная почта: org@eplast1.ru

Адрес: 198099, г. Санкт-Петербург, ул. Калинина, дом 2, корпус 4, литера А.