

General Specifications

Toggle

Rockers

Pushbuttons

Illuminated PB

Programmable

Keylocks

Rotaries

Slides

Tactiles

Tilt

Touch

Indicators

Accessories

Supplement

Electrical Capacity (Resistive Load)

Low/Logic Level: 50mA @ 24V DC maximum for Standard Operating Force models
125mA @ 24V DC maximum for High Operating Force models

Other Ratings

| | Standard Operating Force | High Operating Force |
|---------------------------------|--------------------------------------|--------------------------------------|
| Contact Resistance: | 50 milliohms maximum | 50 milliohms maximum |
| Insulation Resistance: | 500 megohms minimum @ 250V DC | 500 megohms minimum @ 250V DC |
| Dielectric Strength: | 250V AC minimum for 1 minute minimum | 250V AC minimum for 1 minute minimum |
| Mechanical Life: | 5,000,000 operations minimum | 1,000,000 operations minimum |
| Electrical Life: | 5,000,000 operations minimum | 1,000,000 operations minimum |
| Nominal Operating Force: | 1.76N for JB15 | 2.65N for JB15H |
| Total Travel: | .010" (.250mm) | .012" (.300mm) |

Materials & Finishes

| | |
|-----------------------------|--|
| Actuator: | Glass fiber reinforced PBT for Extended actuator; PBT for Flat; Polyacetal for Short |
| Case: | Glass fiber reinforced polyamide (UL94V-0) |
| Seal: | Nitrile butadiene rubber |
| Base: | Glass fiber reinforced PBT (UL94V-0) |
| Movable Contacts: | Stainless steel |
| Stationary Contacts: | Brass with silver plating |
| Terminals: | Brass with silver plating |
| Mounting Bracket: | Phosphor bronze with tin plating |

Environmental Data

| | |
|-------------------------------------|--|
| Operating Temperature Range: | -25°C through +70°C (-13°F through +158°F) |
| Humidity: | 90 ~ 95% humidity for 240 hours @ 40°C (104°F) |
| Vibration: | 10 ~ 55Hz with peak-to-peak amplitude of 1.5mm traversing the frequency range & returning in 1 minute; 3 right angled directions for 2 hours |
| Shock: | 50G (490m/s ²) acceleration (tested in 6 right angled directions, with 5 shocks in each direction) |

PCB Processing

| | |
|-------------------|--|
| Soldering: | Wave Soldering Recommended. See Profile A in Supplement section. Manual Soldering: See Profile A in Supplement section. |
| Cleaning: | Automated cleaning. See Cleaning specifications in Supplement section. |

Standards & Certifications

| | |
|--------------------------------|--|
| Flammability Standards: | UL94V-0 rated case & base The JB Series tactiles have not been tested for UL recognition or CSA certification. These switches are designed for use in a low-voltage, low-current, logic-level circuit. When used as intended in a logic-level circuit, the results do not produce hazardous energy. |
|--------------------------------|--|

Distinctive Characteristics

Special bracket for right angle mounting provides added design variations.

Higher operating force type provides more pronounced operating feel.

Rubber seal construction prevents contact contamination and allows automated soldering and cleaning.

Choice of dimensions from PCB to top of cap allows design flexibility.

Dome contact gives crisp tactile feedback to positively indicate circuit transfer and assures high reliability and long life of up to 5,000,000 operations.

Slanted terminals provide a spring type action which ensures secure mounting and prevents dislodging during wave soldering.

Molded-in terminals are part of the sealed construction which allows automated soldering and washing.

Terminal spacing conforms to standard .100" (2.54mm) PCB grid.



Actual Size



Common Bus Matrix

These single pole, single throw switches can be used in a keyboard matrix and, using strapped terminals, achieve a common bus electrical configuration on a single-sided PC board.

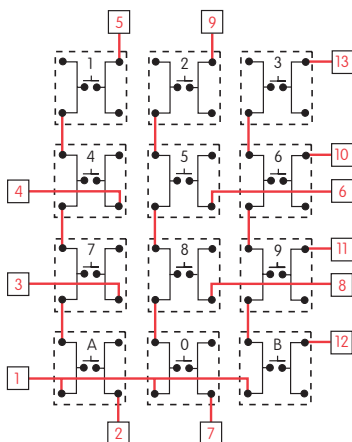

| | | PC Terminations | | | | | | | | | | | | |
|-----------------|---|-----------------|---|---|---|---|---|---|---|---|----|----|----|----|
| | | 1 | 2 | 3 | 4 | 5 | 6 | 7 | 8 | 9 | 10 | 11 | 12 | 13 |
| Keys (Switches) | 1 | | | | | | | | | | | | | |
| | 2 | | | | | | | | | | | | | |
| | 3 | | | | | | | | | | | | | |
| | 4 | | | | | | | | | | | | | |
| | 5 | | | | | | | | | | | | | |
| | 6 | | | | | | | | | | | | | |
| | 7 | | | | | | | | | | | | | |
| | 8 | | | | | | | | | | | | | |
| | 9 | | | | | | | | | | | | | |
| | 0 | | | | | | | | | | | | | |
| | A | | | | | | | | | | | | | |
| B | | | | | | | | | | | | | | |

● = ON

X-Y Matrix

These single pole, single throw switches can be arranged on a single-sided PC board matrix with strapped terminals to achieve an X-Y type electrical interconnection.



| | | PC Terminations | | | | | | |
|-----------------|---|-----------------|---|---|---|---|---|---|
| | | 1 | 2 | 3 | 4 | 5 | 6 | 7 |
| Keys (Switches) | 1 | | | | | | | |
| | 2 | | | | | | | |
| | 3 | | | | | | | |
| | 4 | | | | | | | |
| | 5 | | | | | | | |
| | 6 | | | | | | | |
| | 7 | | | | | | | |
| | 8 | | | | | | | |
| | 9 | | | | | | | |
| | 0 | | | | | | | |
| | A | | | | | | | |
| B | | | | | | | | |

● = ON

Red = PCB Trace Black = Switch Circuit

TYPICAL SWITCH ORDERING EXAMPLE

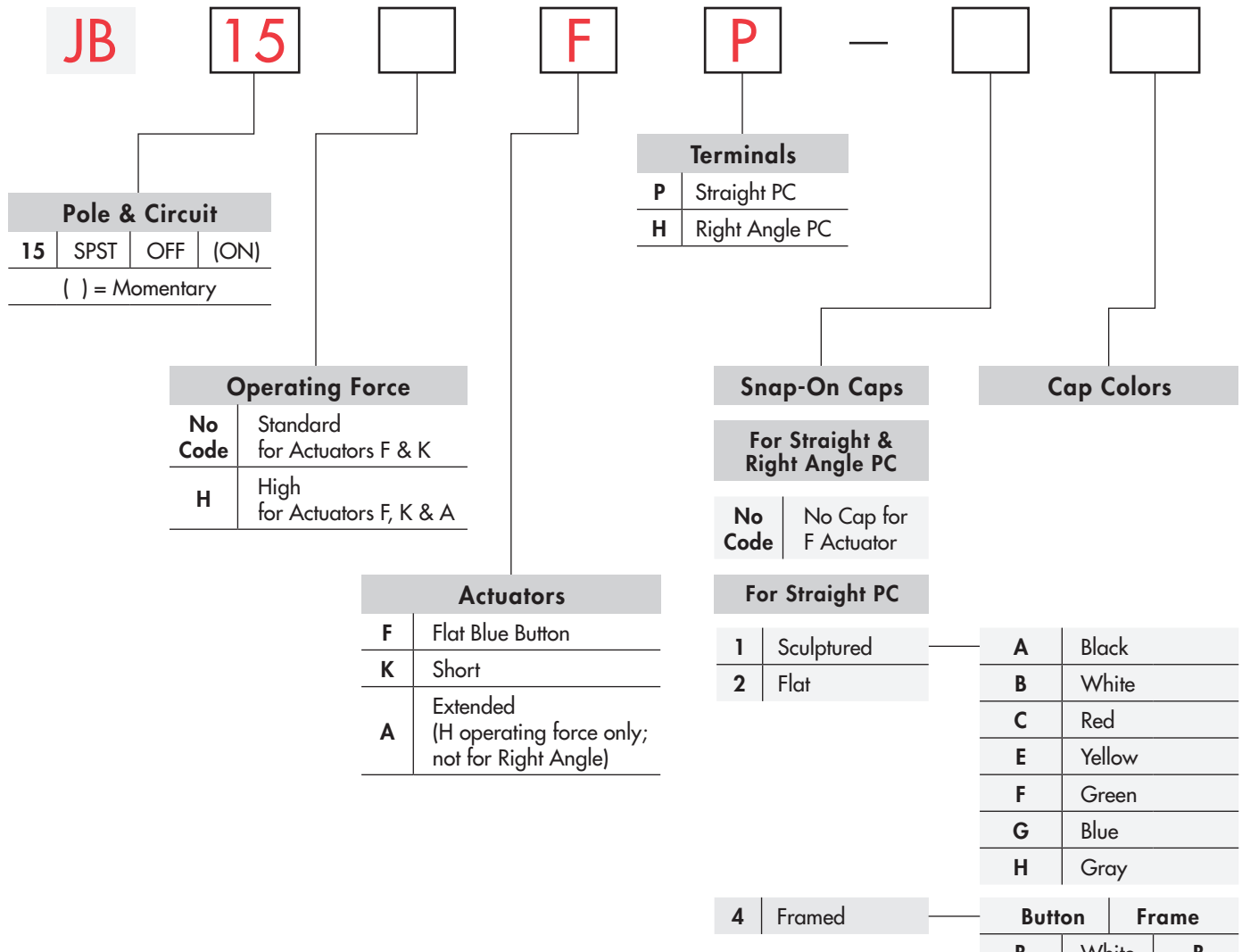

DESCRIPTION FOR TYPICAL ORDERING EXAMPLE

JB15FP

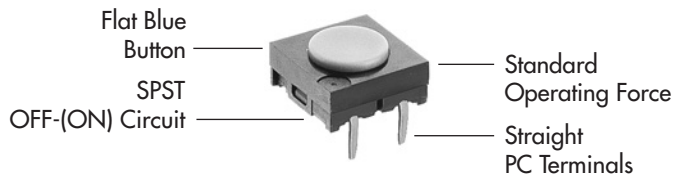

| | | | |
|---------------------------|------------------------|---|-------|
| 5 | Cap with Black Mounter | A | Black |
| | | B | White |
| | | C | Red |
| | | H | Gray |
| For Right Angle PC | | | |
| 6 | Flat | A | Black |
| | | B | White |
| | | C | Red |
| | | H | Gray |

Toggles
Rocker
Pushbuttons
Illuminated PB
Programmable
Keylocks
Rotaries
Slides
Tactiles
Tilt
Touch
Indicators
Accessories
Supplement

POLE & CIRCUIT

| | | Actuator Position () = Momentary | | Switch Throw & Schematic | Note: Terminal numbers are shown on the switch. |
|------|-------|--------------------------------------|------|--------------------------|---|
| Pole | Model | Normal | Down | | |
| SP | JB15 | OFF | (ON) | SPST | |

OPERATING FORCE

No Code

Standard Operating Force
1.76N

For F & K Actuators

H

High Operating Force
2.65N

For F, K & A Actuators

ACTUATORS

F

Flat Blue Button

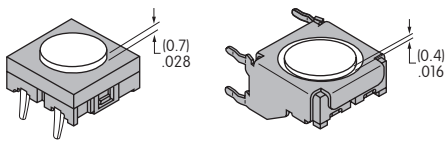

Flat button is an integral part of the switch and cannot be ordered separately.



Custom keyboards can be designed with flat buttons beneath an overlay. Not applicable for right angle mounting.



K

Short Actuator



Custom keyboards can be designed with caps installed through a panel cutout (illustration with framed cap AT4078 and button AT4077). Not applicable for right angle mounting.



A

Extended Actuator

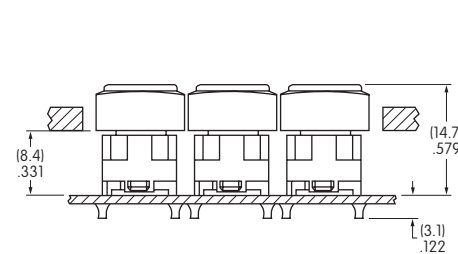

Custom keyboards can be designed with caps installed through a panel cutout (illustration with framed cap AT4078 and button AT4077).



Toggles
Rockers
Pushbuttons
Illuminated PB
Programmable
Keylocks
Rotaries
Slides
Tactiles
Tilt
Touch
Indicators
Accessories
Supplement

TERMINALS

P Straight PC

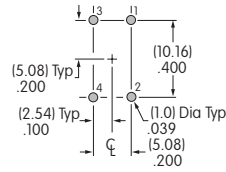

H Right Angle PC

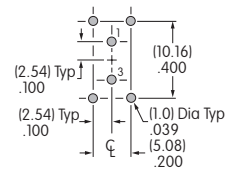

Further details shown in Typical Switch Dimensions

SNAP-ON CAPS

1 AT4058 Sculptured for Straight PC

Material: Polyamide
Finish: Matte
Colors: A B C E F G H

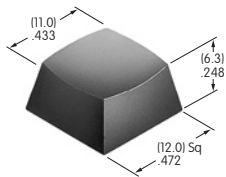

2 AT4059 Flat for Straight PC

Material: Polycarbonate
Finish: Glossy
Colors: A B C E F G H

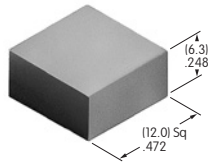

4 Framed: AT4077 Button & AT4078 Frame for Straight PC

Material: Polycarbonate
Finish: Matte
Colors: B C E F G H

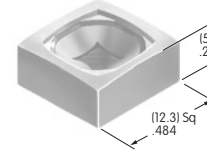
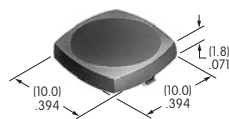

6 AT4139 Flat for Right Angle PC

Material: Polycarbonate
Finish: Glossy
Colors: A B C H

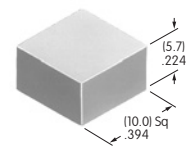

5 AT4140 Cap with AT547 Mounter for Straight PC

Cap
Material: Polycarbonate
Finish: Glossy
Colors: A B C H

Mounter
Material: Polyamide
Finish: Matte
Color: A

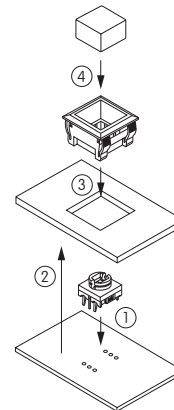

Assembly Procedure

1. Solder switch to PCB.
2. Install PCB in equipment.
3. Snap mounter into panel. Dimension from top of panel to top of PCB is .386" (9.8mm).
4. Snap cap onto plunger.

Panel Cutout & Footprint

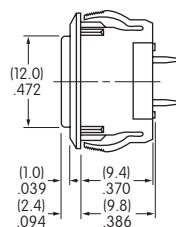
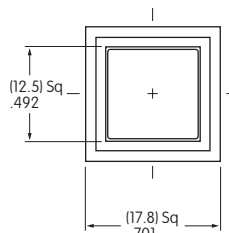

Panel Mounting Dimensions

Panel Thickness:
.039" ~ .079"
(1.0mm ~ 2.0mm)

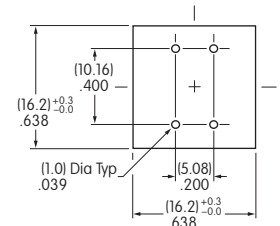

Cap Colors Available:

A Black

B White

C Red

E Yellow

F Green

G Blue

H Gray

Toggles
Rockers
Pushbuttons
Illuminated PB
Programmable
Keylocks
Rotaries
Slides
Tactiles
Tilt
Touch
Indicators
Accessories
Supplement

TYPICAL SWITCH DIMENSIONS

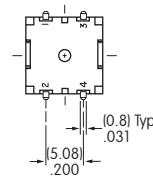
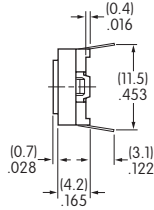
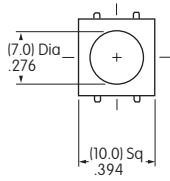

Flat Blue Button • Straight PC



Spring action terminals conform to .100" (2.54mm) PCB spacing

JB15FP

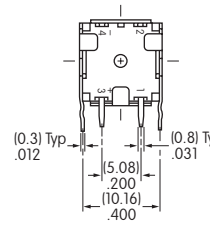
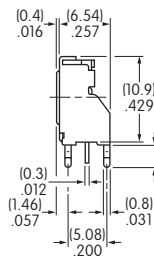

Flat Blue Button • Right Angle PC



JB15FH

Short Actuator

Extended Actuator

Sculptured Snap-on Cap • Straight PC



Spring action terminals conform to .100" (2.54mm) PCB spacing

JB15KP-1C

Short Actuator

Extended Actuator

Flat Snap-on Cap • Straight PC

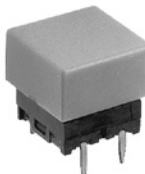
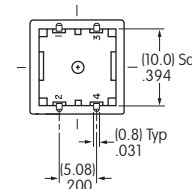
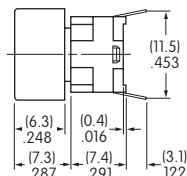
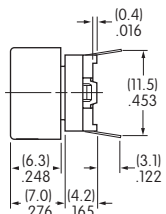
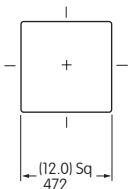

Spring action terminals conform to .100" (2.54mm) PCB spacing

JB15KP-2C

Short Actuator

Extended Actuator

Framed Snap-on Cap • Straight PC

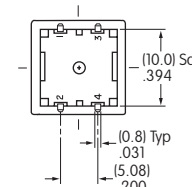
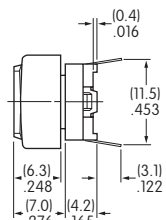

Spring action terminals conform to .100" (2.54mm) PCB spacing

JB15FHAP-4BC

Toggles
Rocker
Pushbuttons
Illuminated PB
Programmable
Keylocks
Rotaries
Slides
Tactiles
Tilt
Touch
Indicators
Accessories
Supplement

TYPICAL SWITCH DIMENSIONS

Flat Snap-on Cap • Right Angle PC



JB15KH-6C

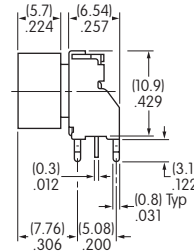
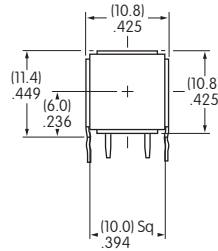

LEGENDS

NKK Switches can provide custom legends for caps. Contact factory for more information.

Shaded Areas are Printable Areas

AT4058

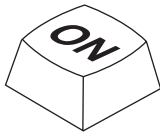

AT4059 & AT4140

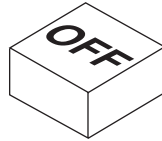

AT4077 Button

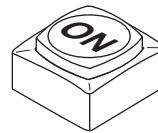

AT4139

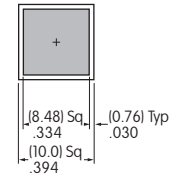
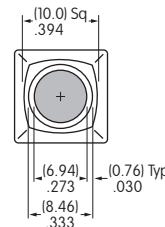
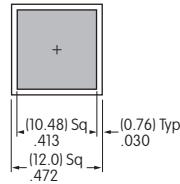
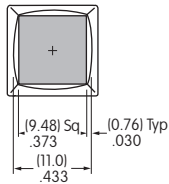

Recommended Print Method: Screen Print or Pad Print. Epoxy based ink is recommended.

Toggles
Rockers
Pushbuttons
Illuminated PB
Programmable
Keylocks
Rotaries
Slides
Tactiles
Tilt
Touch
Indicators
Accessories
Supplement



Компания «ЭлектроПласт» предлагает заключение долгосрочных отношений при поставках импортных электронных компонентов на взаимовыгодных условиях!

Наши преимущества:

- Оперативные поставки широкого спектра электронных компонентов отечественного и импортного производства напрямую от производителей и с крупнейших мировых складов;
- Поставка более 17-ти миллионов наименований электронных компонентов;
- Поставка сложных, дефицитных, либо снятых с производства позиций;
- Оперативные сроки поставки под заказ (от 5 рабочих дней);
- Экспресс доставка в любую точку России;
- Техническая поддержка проекта, помощь в подборе аналогов, поставка прототипов;
- Система менеджмента качества сертифицирована по Международному стандарту ISO 9001;
- Лицензия ФСБ на осуществление работ с использованием сведений, составляющих государственную тайну;
- Поставка специализированных компонентов (Xilinx, Altera, Analog Devices, Intersil, Interpoint, Microsemi, Aeroflex, Peregrine, Syfer, Eurofarad, Texas Instrument, Miteq, Cobham, E2V, MA-COM, Hittite, Mini-Circuits, General Dynamics и др.);

Помимо этого, одним из направлений компании «ЭлектроПласт» является направление «Источники питания». Мы предлагаем Вам помощь Конструкторского отдела:

- Подбор оптимального решения, техническое обоснование при выборе компонента;
- Подбор аналогов;
- Консультации по применению компонента;
- Поставка образцов и прототипов;
- Техническая поддержка проекта;
- Защита от снятия компонента с производства.



Как с нами связаться

Телефон: 8 (812) 309 58 32 (многоканальный)

Факс: 8 (812) 320-02-42

Электронная почта: org@eplast1.ru

Адрес: 198099, г. Санкт-Петербург, ул. Калинина, дом 2, корпус 4, литера А.