

# EE-SY1200

## Photomicrosensor (Reflective)

### ■ Dimensions

(Unit: mm)

Note.  
Unless otherwise specified tolerances are  $\pm 0.15$ .  
No burrs dimensions are included in out-line dimensions.  
The burrs dimensions are 0.15 MAX.  
Diagonal line indicate the region is part Au plating area.

**Recommended Soldering Pattern**

Note 1. The shaded portion in the above figure may cause shorting. Do not wire in this portion.  
2. The dimensional tolerance for the recommended soldering pattern is  $\pm 0.1$  mm.

**Internal Circuit**

Terminal No.	Name
A	Anode
K	Cathode
C	Collector
E	Emitter

### ■ Features

- Ultra-compact model.
- PCB surface mounting type.
- High S/N ratio  
(High light current / Low leakage current)

### ■ Absolute Maximum Ratings (Ta=25°C)

Item	Symbol	Rated value	Unit
Emitter	Forward current	$I_F$	50 <sup>*1</sup>
	Pulse forward current	$I_{FP}$	500 <sup>*2</sup>
	Reverse voltage	$V_R$	4
Detector	Collector-Emitter voltage	$V_{CEO}$	30
	Emitter-Collector voltage	$V_{ECO}$	5
	Collector current	$I_C$	20
	Collector dissipation	$P_C$	50 <sup>*1</sup>
Operating temperature	$T_{opr}$	-25 to +85	°C
Storage temperature	$T_{stg}$	-40 to +100	°C
Reflow soldering temperature	$T_{sol}$	240 <sup>*3</sup>	°C

- \*1. Refer to the temperature rating chart if the ambient temperature exceeds 25°C.  
\*2. The pulse width is 10  $\mu$ s maximum with a frequency of 100 Hz.  
\*3. Complete soldering within 10 seconds for reflow soldering.

### ■ Electrical and Optical Characteristics (Ta=25°C)

Item	Symbol	Value			Unit	Condition	
		MIN.	TYP.	MAX.			
Emitter	Forward voltage	$V_F$	---	1.2	1.4	V	$I_F = 20$ mA
	Reverse current	$I_R$	---	---	10	$\mu$ A	$V_R = 4$ V
	Peak emission wavelength	$\lambda_P$	---	940	---	nm	---
Detector	Light current 1	$I_{L1}$	200	---	1000	$\mu$ A	$I_F = 10$ mA, $V_{CE} = 2$ V, Aluminum-deposited surface, $d = 4$ mm <sup>*1</sup>
	Light current 2	$I_{L2}$	150	---	---	$\mu$ A	$I_F = 4$ mA, $V_{CE} = 2$ V, Aluminum-deposited surface, $d = 1$ mm <sup>*1</sup>
	Dark current	$I_D$	---	2	200	nA	$V_{CE} = 10$ V, 0 lx
	Leakage current 1	$I_{LEAK1}$	---	---	500	nA	$I_F = 10$ mA, $V_{CE} = 2$ V, with no reflection <sup>*2</sup>
	Leakage current 2	$I_{LEAK2}$	---	---	200	nA	$I_F = 4$ mA, $V_{CE} = 2$ V, with no reflection <sup>*2</sup>
	Collector-Emitter saturated voltage	$V_{CE(sat)}$	---	---	---	V	---
	Peak spectral sensitivity wavelength	$\lambda_P$	---	850	---	nm	---
Rising time	$t_r$	---	30	---	$\mu$ s	$V_{CC} = 2$ V, $R_L = 1$ k $\Omega$ , $I_L = 100$ $\mu$ A, $d = 1$ mm <sup>*1</sup>	
Falling time	$t_f$	---	30	---	$\mu$ s	$V_{CC} = 2$ V, $R_L = 1$ k $\Omega$ , $I_L = 100$ $\mu$ A, $d = 1$ mm <sup>*1</sup>	

\*1. The letter "d" indicates the distance between the top surface of the sensor and the sensing object.  
\*2. Depends on the installed condition of the Photomicrosensor, the detector may receive the sensor's LED light and/or the external light which is reflected from surroundings of the Photomicrosensor and/or the background object.  
Please confirm the condition of the Photomicrosensor by actual intended application prior to the mass production use.

Engineering Data

Fig 1. Forward Current vs. Collector Dissipation Temperature Rating

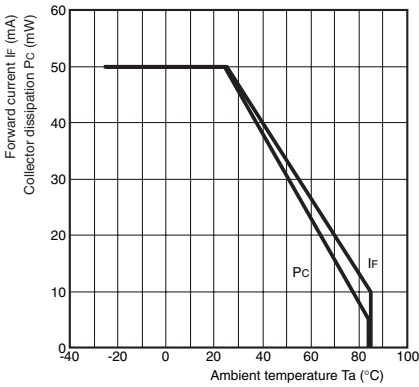

Fig 4. Light Current vs. Collector-Emitter Voltage Characteristics (Typical)

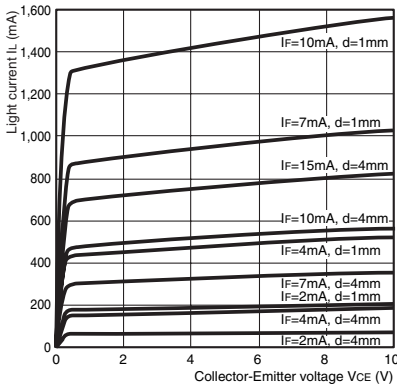

Fig 7. Response Time vs. Load Resistance Characteristics (Typical)

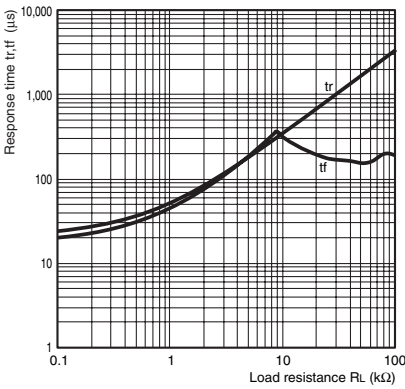

Fig 10. Sensing Position Characteristics (Typical)

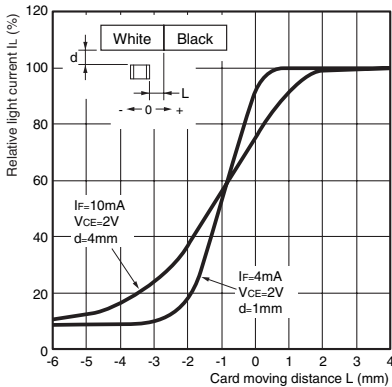

Fig 2. Forward Current vs. Forward Voltage Characteristics (Typical)

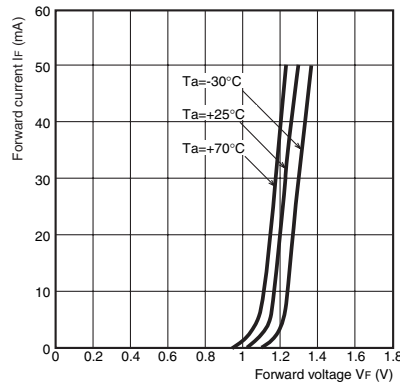

Fig 5. Relative Light Current vs. Ambient Temperature Characteristics (Typical)

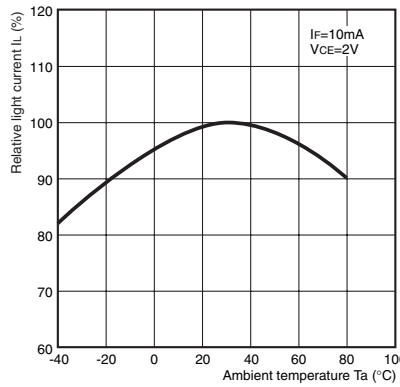

Fig 8. Sensing Distance Characteristics (Typical)

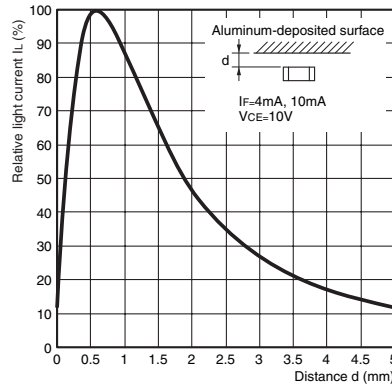

Fig 11. Response Time Measurement Circuit

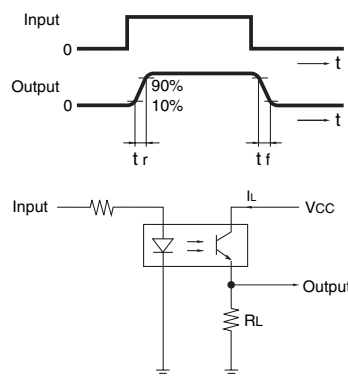

Fig 3. Light Current vs. Forward Current Characteristics (Typical)

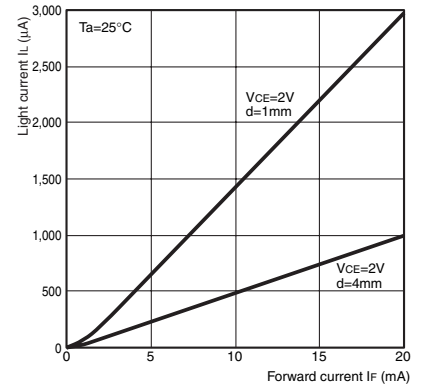

Fig 6. Dark Current vs. Ambient Temperature Characteristics (Typical)

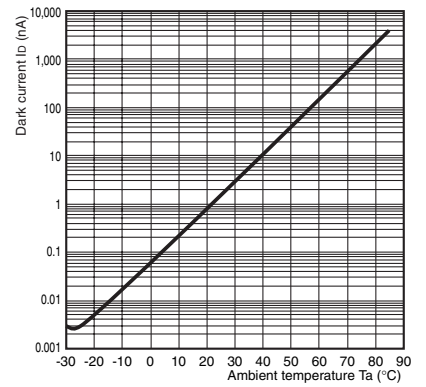

Fig 9. Sensing Position Characteristics (Typical)

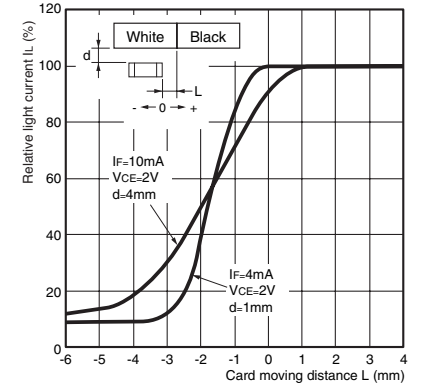
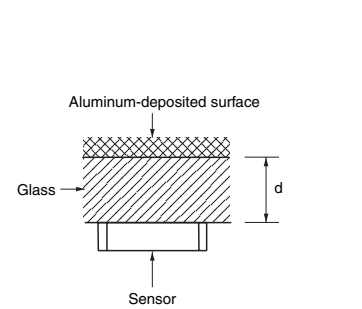

Fig 12. Light Current Measurement Setup Diagram



# EE-SY1200

## ■ Tape and Reel

### ● Reel Dimension (Unit: mm)

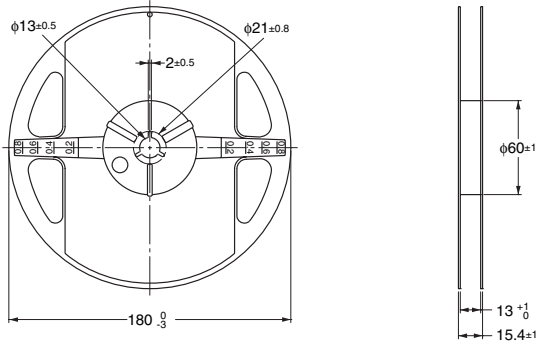

### ● Tape Dimension (Unit: mm)

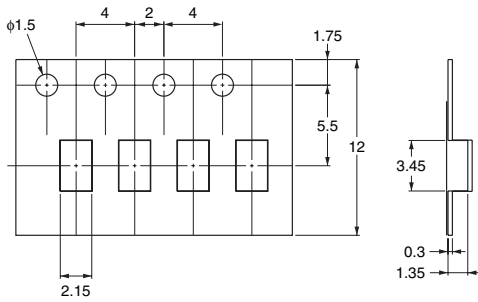

### ● Part Mounting Direction

- The devices are oriented in the rectangular holes in the carrier tape so that the edge with the LED faces the round feeding holes.

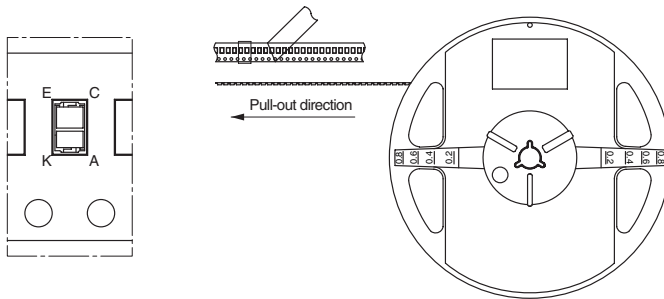

### ● Tape Quantity

2,000 pcs./reel

**■ Precautions to be taken on mounting**

**● Temperature Profile**

The reflow soldering can be implemented in two times complying with the following diagram. All the temperatures in the product must be within the diagram.

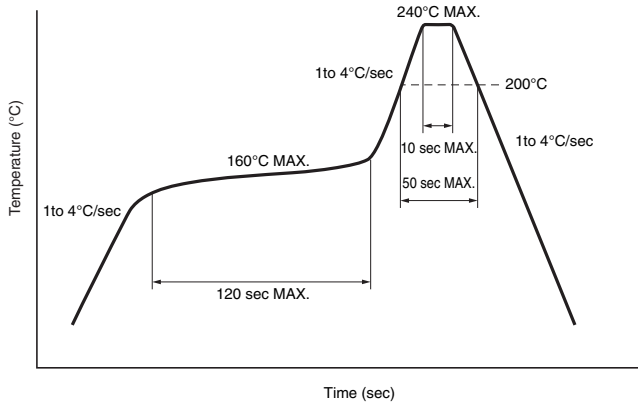

**● Manual soldering**

The manual soldering cannot be applied to the products. There is a possibility that the housing is deformed and/or Au plating is peeled off by heat.

**● Other Notes**

The use of infrared lamp causes the temperature at the resin to rise particularly too high. All the temperatures in the product must be within the above diagram. Do not immerse the resin part into the solder. Even if within the above temperature diagram, there is a possibility that the gold wire in the products is broken in case that the deformation of PCB gives the stress to the product terminals. Please confirm the conditions of the reflow soldering fully by actual solder reflow machine prior to the mass production use.

**■ Storage and Handling after Opening**

**● Storage Conditions**

In order to avoid the absorption of moisture, the products shall be stored in a dry box with desiccant or in the following conditions.  
 Storage temp. : 5 to 30°C  
 Storage humidity : 70%RH or less

**● Treatment after Opening**

1. Reflow soldering must be done within 48 hours stored at the conditions of humidity 60%RH or less and temperature 5 to 25°C.
2. In case of long time storage after open, please mount at the conditions of humidity 70%RH or less and temperature 5 to 30°C within 1 week by using dry box or resealing with desiccant in moisture-proof bag by sealer.

**● Baking before Mounting**

In case that it could not carry out the above treatment, it is able to mount by baking treatment. However baking treatment shall be limited only 1 time.  
 Recommended conditions : 60°C, 12 to 24 hours (reeled one)  
 100°C, 8 to 24 hours (loose one)



Компания «ЭлектроПласт» предлагает заключение долгосрочных отношений при поставках импортных электронных компонентов на взаимовыгодных условиях!

Наши преимущества:

- Оперативные поставки широкого спектра электронных компонентов отечественного и импортного производства напрямую от производителей и с крупнейших мировых складов;
- Поставка более 17-ти миллионов наименований электронных компонентов;
- Поставка сложных, дефицитных, либо снятых с производства позиций;
- Оперативные сроки поставки под заказ (от 5 рабочих дней);
- Экспресс доставка в любую точку России;
- Техническая поддержка проекта, помощь в подборе аналогов, поставка прототипов;
- Система менеджмента качества сертифицирована по Международному стандарту ISO 9001;
- Лицензия ФСБ на осуществление работ с использованием сведений, составляющих государственную тайну;
- Поставка специализированных компонентов (Xilinx, Altera, Analog Devices, Intersil, Interpoint, Microsemi, Aeroflex, Peregrine, Syfer, Eurofarad, Texas Instrument, Miteq, Cobham, E2V, MA-COM, Hittite, Mini-Circuits, General Dynamics и др.);

Помимо этого, одним из направлений компании «ЭлектроПласт» является направление «Источники питания». Мы предлагаем Вам помощь Конструкторского отдела:

- Подбор оптимального решения, техническое обоснование при выборе компонента;
- Подбор аналогов;
- Консультации по применению компонента;
- Поставка образцов и прототипов;
- Техническая поддержка проекта;
- Защита от снятия компонента с производства.



#### Как с нами связаться

**Телефон:** 8 (812) 309 58 32 (многоканальный)

**Факс:** 8 (812) 320-02-42

**Электронная почта:** [org@eplast1.ru](mailto:org@eplast1.ru)

**Адрес:** 198099, г. Санкт-Петербург, ул. Калинина, дом 2, корпус 4, литера А.