

| Description | Page Number(s) |
|--|-------------------|
| Portable Labeling Systems and Printers | 5-26 |
| Pan-Quik™ LS3E Hand-Held Dot-Matrix Printer | 6-11 |
| LS5 and LS5E Industrial Labeling Systems | 12-14 |
| LS4H Heat Shrink / Laminated Tape Labeling System | 15 |
| LS4M Multiple Line Portable Labeling System | 16 |
| PTR1 Flat-Bed Dot-Matrix Printer | 17-19 |
| DURA-MARK™ PTR2 Thermal Transfer Printer | 20-25 |
| PTR3 Thermal Transfer Printer | 26 |
| Software | 27-32 |
| PAN-MARK™ for WINDOWS^ | 28 |
| PAN-MARK LT for DOS | 29 |
| PROG-LITE Software for PTR1 Printer | 30 |
| SAFETY EASE™ Marker and Tag Software..... | 31-32 |
| Thermal Transfer Labels | 33-47 |
| Suggested Applications | 34-35 |
| Material Selection Guide | 36 |
| Label Listing by Material | 36-39 |
| Network Systems Labels..... | 40-41 |
| Label Drawings - Labels Listed by Size..... | 42-44 |
| Heat Shrink Labels for Thermal Transfer | 45 |
| Thermal Transfer Ribbons | 46-47 |
| Ink Jet Labels | 49-56 |
| Suggested Applications | 50-50 |
| Material Selection Guide | 51 |
| Label Listing by Material | 51-52 |
| Network Systems Labels..... | 53 |
| Label Drawings - Labels Listed by Size..... | 55-56 |
| Smear Resistant Ink Jet Cartridges and Refills | 54 |
| Laser Printable Labels | 57-77 |
| Suggested Applications | 58-59 |
| Material Selection Guide | 60 |
| Label Listing by Material | 60-66 |
| Network Systems Labels..... | 67-69 |
| Label Drawings - Labels Listed by Size..... | 70-77 |
| Dot-Matrix Labeling Products | 79-130 |
| Dot-Matrix Labels | 80-121 |
| Suggested Applications | 81-83 |
| Material Selection Guide | 84 |
| Self-Laminating Label Listing by Material | 85-87 |
| Blank Label Listing by Material | 88-96 |
| Network Systems Labels..... | 97-100 |
| Machinery Materials Identification Labels | 101 |
| Typewriter Sheets | 102 |
| Paper Labels..... | 103-105 |
| Self-Laminating Label Drawings - Labels Listed by Size | 106-111 |
| Blank Label Drawings - Labels Listed by Size | 112-121 |

Table of Contents

| Description | Page Number(s) |
|--|----------------|
| Dot-Matrix Heat Shrink Label Kits | 122 |
| Heat Shrink Tools and Accessories | 123 |
| Dot-Matrix Data Plates | 124-125 |
| Suggested Applications | 124 |
| Material Selection Guide | 125 |
| Label Drawings - Labels Listed by Size | 125 |
| Dot-Matrix Indelible Ink Ribbons | 126-128 |
| Suggested Applications | 126 |
| Ribbons by Printer Model..... | 127-128 |
| Marker Ties and Marker Plates..... | 129-130 |
| Wire Marking Products..... | 132-150 |
| Marker Books | 132-137 |
| Marker Cards | 138-147 |
| Wire Marker Tape Dispenser and Rolls | 148 |
| Slip-On Wire Markers | 149 |
| Clip-On Wire Markers..... | 150 |
| Cable Marking Products..... | 151-155 |
| Self-Laminating Cable Marker Holders | 152 |
| Clear Heat Shrink Tubing for Protected Wire and Cable Marking..... | 153 |
| Fiber Optic Cable Tags and Markers | 154 |
| Underground Hazard Tape..... | 155 |
| Electrical, Voltage and Fiber Optic Markers | 157-160 |
| Voltage and Fiber Optic Markers | 157-158 |
| Voltage and Ampere Markers | 159 |
| Electrical Symbols | 160 |
| Warning Labels | 161-167 |
| Static Awareness Labels | 162 |
| Electrical Hazard Labels | 163-164 |
| Packaging / Shipping Labels..... | 165 |
| ISO Labels..... | 166-167 |
| Quality Assurance, Inspection and Industrial Labels | 169-180 |
| Calibration Labels | 170-171 |
| Quality Assurance Labels and Tags..... | 172-175 |
| Inspection Labels and Tags | 176-178 |
| Production Control Tags..... | 179-180 |
| Reference Pages | 181-204 |
| Computer Printable Labels by Size | 181-195 |
| Wire Size Selection Guide | 196 |
| Alpha-Numeric Part Number Index..... | 197-204 |

Meet your on-site labeling needs *FAST* with the *Pan-Quik*[™] LS3E Hand-Held Printer from Panduit

With 20 Kb Memory to Save, Recall and Edit Label Files

Fast

Affordable

Easy to Use

Versatile

Other Features

- Flexibility to print self-laminating wire markers, heat shrink markers, component labels, asset identification labels and more
- Fast drying self-laminating labels reduce installation time
- Automatic recall of last legend entered
- Easy formatting options reduce set-up time
- Automatic serialization and legend repeat functions
- Quick change battery pack and optional AC adapter for reduced downtime
- More than 25 font styles and sizes
- Exact label registration

See [pages 6-11](#) for complete information



Printer Selection Matrix

| | Printers | | | | | | |
|----------|-----------------|----------------------|------------------|------------------|------------------|------------------|------------------|
| Features | LS3E (Pg. 6) | LS5/LS5E (Pg. 12) | LS4H (Pg. 15) | LS4M (Pg. 16) | PTR1 (Pg. 17) | PTR2 (Pg. 20) | PTR3 (Pg. 26) |

Label Options

| | | | | | | | |
|-------------------------------|-----|-----|-----|-----|-----|-----|-----|
| Self-Laminating Wire Markers | Yes | Yes | No | No | Yes | Yes | Yes |
| Solid Wire Markers | Yes | Yes | No | No | Yes | Yes | Yes |
| Heat Shrink Markers | Yes | Yes | Yes | No | Yes | Yes | Yes |
| Component Markers | Yes | Yes | No | No | Yes | Yes | Yes |
| Terminal Block Markers | Yes | No | No | No | Yes | No | No |
| Industrial Laminated Tape | No | Yes | Yes | Yes | No | No | No |
| Commercial Non-Laminated Tape | No | Yes | No | Yes | No | Yes | Yes |

Mechanical Specifications

| | | | | | | | |
|---|----------------------------------|-----------------------------------|----------------------|----------------------|---------------------------|---------------------------|---------------------------|
| Type | Hand-Held | Hand-Held | Portable | Portable | Desktop | Desktop | Desktop |
| Print Method | 9-Pin Dot-Matrix | Thermal Transfer | Thermal Transfer | Thermal Transfer | 24-Pin Dot-Matrix | Thermal Transfer | Thermal Transfer |
| Volume | Low | Low | Low | Low | Medium to High | Medium to High | High |
| Label Widths | 0.25" - 1.50" (6.4 - 38.1 mm) | 0.50" - 1.00" (12.7 - 25.4 mm) | 0.50" (12.7 mm) | 0.50" (12.7 mm) | Up to 8.50" (215.9 mm) | Up to 4.10" (104.1 mm) | Up to 5.00" (127.0 mm) |
| Weight | 2.7 lbs. (1.2 kg) | 4.7 lbs. (2.1 kg) | 3.5 lbs. (1.6 kg) | 3.5 lbs. (1.6 kg) | 10 lbs. (4.5 kg) | 4 lbs. (1.8 kg) | 40 lbs. (18 kg) |
| Power Supply | Battery Pack or AC | Batteries or AC | Batteries or AC | Batteries or AC | AC | AC | AC |
| PC Interface Required | No | No | No | No | Yes | Yes | Yes |
| Optical Registration for Exact Print Registration | Yes | Yes | N/A | N/A | N/A | Yes | Yes |
| Memory | 20 Kb | LS5 - 16Kb, LS5E - 450Kb | No | No | N/A | N/A | N/A |
| RS232 Port | No | Yes | No | No | Computer Interface | Computer Interface | Computer Interface |
| Cutter | No | Yes | Yes | Yes | No | No | No |

Print Options

| | | | | | | | |
|---------------------------------|--------------------------------------|---------------------|---------------------|----------------------------------|------------------------|----------------------------------|-----------------------------------|
| Print Sizes | Small, Compressed, Normal, Large | 6 point to 72 point | 8 point to 16 point | 6 point to 24 point | All WINDOWS* fonts | 0.06" - 3.50" (1.5 - 88.9 mm) | 0.06" - 4.10" (1.5 - 104.1 mm) |
| Lines of Variable Print | 47 | 6 | 1 | 4 | Dependent on software | Dependent on software | Dependent on software |
| Upper and Lower Case | Yes | Yes | Yes | Yes | Yes | Yes | Yes |
| Underline / Rotated / Bold Text | Yes | Yes | Yes | Yes | Yes | Yes | Yes |
| Serialization | Yes | Yes | Yes | Yes | Yes | Yes | Yes |
| Bar Codes | No | Yes | No | Yes (with optional font card) | Yes | Yes | Yes |
| Special Print Modes | Wire Marker, Center, Strip, Terminal | None | None | None | Yes (with software) | Yes | Yes |

PANDUIT® Portable Labeling Systems and Printers

Select the system that suits your labeling application:



Pan-Quik™ LS3E Hand-Held Dot-Matrix Printer **Pages 6 - 11**

- Lightweight, versatile printer for high quality labels that you can print anytime, anywhere
- Prints wire markers, heat shrink markers, component labels and network labels faster than other hand-held, dot-matrix printers
- Features the **Quik-Key™** Fast Label Formatting System



LS5 and LS5E Industrial Labeling Systems **Pages 12 - 14**

- Hand-held, thermal transfer labeling system designed to meet the rugged demands of industrial labeling applications
- Prints self-laminating markers, die-cut labels, heat shrink markers, tamper evident tape, laminated tape and non-laminated tape
- Alpha and numeric sequencing and bar code capabilities



LS4H Heat Shrink / Laminated Tape Labeling System **Page 15**

- High performance, self-contained thermal transfer labeling system that produces high quality, permanent tube markers and scratch resistant laminated polyester component markers
- Compact, portable size allows usage anywhere



LS4M Multiple Line Portable Labeling System **Page 16**

- High performance, self-contained labeling system that prints up to four lines of text on 0.50" (12.7 mm) wide adhesive tape
- Provides durable, high quality, permanent labels



PTR1 Flat-Bed, Dot-Matrix Printer **Pages 17 - 19**

- Produces **ON-DEMAND™** Wire Marker Cards, Self-Laminating Wire Markers, Heat Shrink Labels — any pin-fed label!
- Straight label path eliminates the potential for jamming
- Adjustable print head gap eliminates smearing, especially on thick material such as heat shrink



DURA-MARK™ PTR2 Thermal Transfer Printer **Pages 20 - 25**

- High quality, thermal transfer printer for medium to high volume printing applications
- Create your own custom wire markers, heat shrink markers, bin markers and large labels with characters up to 3.5" (89 mm) high
- Flexibility at your fingertips!



PTR3 Thermal Transfer Printer **Page 26**

- Fast, rugged, thermal transfer printer for high volume printing applications
- Prints crisp, quality 203 dpi resolution images at speeds up to 10 inches per second
- 16 bar code symbologies plus 12 fonts are built in for making labels with minimum programming and fast data transfer

Pan-Quik™ LS3E Hand-Held Dot-Matrix Printer Features

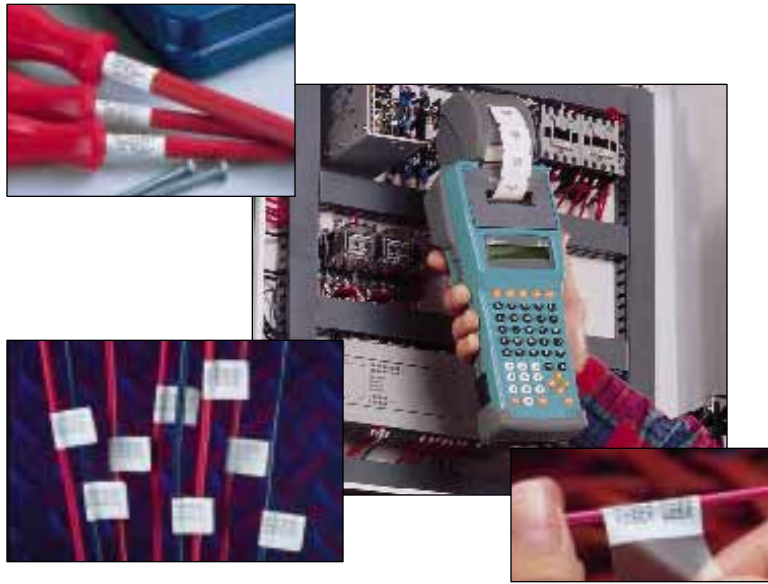

Finally, there's a fast, reliable hand-held printer that creates crisp, clear legends in a variety of sizes, is simple to use, easy to load and offers long battery life. All at an affordable price!

The **Pan-Quik** LS3E printer lets you quickly create custom or serialized labels, wire markers, heat shrink markers, component labels, and network labels, all for greater time savings and convenience. You can save and retrieve files so its easy to produce labels with frequently used formats and legends. Labels are available with widths from 0.25" to 1.50" (6.4 mm to 38.1 mm) in a variety of materials. It's the versatile, easy way to identify wires, cables, modular jacks, faceplates, terminal blocks and patch panels.

It's perfect for on-site project locations and quick maintenance applications.

Printing That Outperforms The Competition

| Features | Benefits |
|--|---|
| Instant Labels | Prints custom labels in a matter of seconds. |
| Print Head Travels Only as Far as Legend Requires | Labels with shorter legends print even faster! |
| Express Formatting Option to Set all Print Characteristics at One Time | Eliminate formatting set-up time for frequently used label formats such as wire marking, component identification and patch panel labeling. |
| Quik-Key™ Fast Label Formatting System | Fast set-up for: text font, size, case and position; print density and label format. |
| Automatic Recall of Last Label Entered | No need to reenter information after shut-off or recharging battery pack. |
| Save and Retrieve Files | Save time when printing frequently used labels. |
| Multi-Language Screen Prompts | Choose from English, German, French, Italian, Dutch, Spanish and Portuguese language screen prompts as needed. |
| Letter Quality Font | Produce top-quality labels with clear, crisp legends. |
| Rotated Text | Run type horizontal or rotated, whichever best meets your need. |
| Underlined Text | Separates headings or emphasizes words. |
| Small Text Size | More lines per lineal inch. |
| Automatic Serialization of Labels | Serialize in Numeric or Alphabetic sequence. Saves time when printing a series of labels. |
| Automatic Repeat of Legend | Able to print wire markers quickly and efficiently. Saves time when printing duplicate labels. |
| Portable / Battery-Operated | Able to go anywhere. Can go on-site easily to every job. No AC power required. |
| Long Battery Life | Increased efficiency with more labels produced between battery charges. |
| Easy Loading | Less downtime for changeover. |
| 9-Pin Dot-Matrix Print Head | Printed legends are easy to read. More pins for faster speed and better print quality. |
| Optical Sensor | Provides perfect label registration; minimizes set-up time and wasted labels. |
| Lightweight | Less operator fatigue. Easy to handle and use. |
| AC Adapters Available | Print more labels without having to recharge battery. |
| On-Demand Printing | Just-in-time labels. Creates the label you want, when you want it. |
| Versatile | One printer to print labels, vinyl cloth wire markers, self-laminating wire markers, heat shrink wire markers, component labels, and data communication labels. |
| Custom Markers at Lower Cost | Reduces inventory carrying costs. |
| Easy to Use / User Friendly | No special training required. Anyone can make labels. |

Pan-Quik™ LS3E Hand-Held Dot-Matrix Printer and Accessories



Printer Mechanical Information

Print Method: 9 pin dot-matrix print head

Size: Height: 3.6" (91.9 mm)
 Width: 4.2" (108.0 mm)
 Length: 13.2" (336.6 mm)
 Weight: 2.7 lbs. (1.2 kg)

Display: Two-line x 16 character liquid crystal display

Keyboard: 49 color coded keys with ergonomically designed keypad

Power Source: 12 VDC, 1200 mAh rechargeable Ni-Cad Battery Pack (Included)

Printer

| Part Number | Description | Plug Type | Manual Language | Std. Pkg. Qty.* |
|-------------|--|--------------------|-----------------|-----------------|
| LS3E† | Includes Printer, Battery Pack, Battery Charger, Printer Ribbon, Wrist Strap and Operator's Manual | North American 120 | English | 1 |
| LS3E-PS | | | Portuguese | |
| LS3E-ES | | | Spanish | |
| LS3E-KIT | Includes all components of LS3E printer shown above plus LS3EAK-S AC Adapter and Carrying Case | North American 120 | English | 1 |

†Also available with Euro 230, U.K. 240 and Australian 240 Plugs and Operator's Manuals in Chinese, Dutch, French, German, Italian and Japanese. Contact factory for complete part number information.



Replacement Parts and Optional Accessories

| Part Number | Description | Plug Type | Std. Pkg. Qty.* |
|-------------|--|--------------------|-----------------|
| LS3-RIB | Replacement Printer Ribbon | — | 1 |
| LS3E-BP | Replacement Battery Pack | — | 1 |
| LS3EC-S | Replacement North American 120V Battery Charger <i>Used only to charge LS3E battery. Cannot be used to power LS3E directly from Power Outlet.</i> | North American 120 | 1 |
| LS3E-MAN-A† | Replacement Operator's Manual - English | — | 1 |
| LS3EACS‡ | 1 each: Universal AC Adapter (LS3EA), Battery Charging Pack (LS3E-CP) and Power Cord Listed (CORD-*) <i>Power LS3E directly from Power Outlet and charge LS3E Battery Pack at the same time</i> | North American 120 | 1 |
| LS3EAK-S‡ | 1 each: Universal AC Adapter (LS3EA) and Power Cord Listed (CORD-*) <i>Power LS3E directly from Power Outlet</i> | North American 120 | 1 |
| LS3ECAP | 1 each: Battery Charging Pack (LS3E-CP) and Auto Plug (LS3EAP) <i>Power LS3E directly from Auto Cigarette Lighter and charge LS3E Battery Pack at the same time</i> | — | 1 |
| LS3EAP | Replacement Auto Plug <i>Power LS3E directly from Auto Cigarette Lighter</i> | — | 1 |

†To order Operator's Manual in other languages, replace -A with -C for Chinese, -N for Dutch, -F for French, -D for German, -I for Italian, -J for Japanese, -P for Portuguese, and -E for Spanish

‡Also available with Euro 230, U.K. 240 and Australian 240 Plugs. Contact factory for complete part number information.



LS3-RIB



LS3E-BP



LS3EC-S



LS3E-MAN-A



LS3EACS



LS3EAK-S



LS3ECAP



LS3EAP

PANUIT® Pan-Quik™ LS3E Hand-Held Printer

Optional Accessories (cont.)

| Part Number | Description | Plug Type | Std. Pkg. Qty.* |
|-------------|---|--------------------|-----------------|
| LS3E-CP | Replacement Battery Charging Pack <i>Power LS3E directly from AC Power Source and charge LS3E Battery Pack at the same time (Must be used with Universal AC Adapter and Power Cord - not included)</i> | — | 1 |
| LS3EA | Universal AC Adapter | — | 1 |
| CORD-S† | Replacement Power Cord | North American 120 | 1 |
| LS3-CASE | Carrying Case | — | 1 |
| LS3-BS | Printer Belt Holster | — | 1 |
| PTR-CLN | Printer Cleaning Kit Contains 4 oz. (116 ml) bottle cleaning solution with MSDS, cleaning pen, 100 swabs, 12 alcohol wipes and instructions | — | 1 |



LS3E-CP



LS3EA



CORD-S

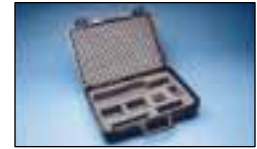

LS3-CASE



LS3-BS



PTR-CLN

†Also available with Euro 230, U.K. 240 and Australian 240 Plugs. Contact factory for complete part number information.

*Order number of accessories required in multiples of Std. Pkg. Qty.

Material Selection

| Material Type | Temperature Range | Description | Key Feature | Color | Outdoor Rated | Hazardous Environment* | UL Rec. | CSA |
|--------------------------|-------------------------------|---|---|---------------|---------------|------------------------|---------|-----|
| SELF-LAMINATING VINYL | -40° to 150°F (-40° to 68°C) | Self-laminating film for most general wire and cable labeling | Low cost, conformable material | Clear | No | No | Yes | Yes |
| SELF-LAMINATING TEDLAR † | -0° to 275°F (-18° to 135°C) | Self-laminating film for wire and cable labeling in outdoor, high temperature or harsh environments | Resistant to high temperatures and U.V. light | Clear | Yes | Yes | Yes | Yes |
| VINYL CLOTH | -50° to 170°F (-46° to 77°C) | General purpose material, vinyl impregnated cloth resists oil and abrasion | Material can be removed and reused | White | No | No | No | No |
| METALLIZED POLYESTER | -40° to 311°F (-40° to 154°C) | Metallized polyester for property and asset marking | Durable material; does not stretch or easily tear | Silver | Yes | Yes | No | No |
| HEAT SHRINK POLYOLEFIN | -22° to 220°F (-30° to 105°C) | Polyolefin heat shrink for wire marking applications, excellent print quality | Secure identification | White, Yellow | No | No | No | No |

†TEDLAR is the registered trademark of E. I. DuPont Co.

*For complete material specification information, contact Product Management at 1-888-506-5400, ext. 7337

The label codes shown in each chart are distinct codes used to tell the printer the size of the label.

NEW! Wire Marker Strips

- Eliminate the carrying costs, shelf-life and inventory concerns of preprinted marker cards
- Marker strips are perforated so they can be used as full size or half size markers in wrap-around or flag style
- Custom firmware for fast and easy on-site wire marking
- Backscore on liner makes strips easy to remove and apply
- Material: White Vinyl Cloth

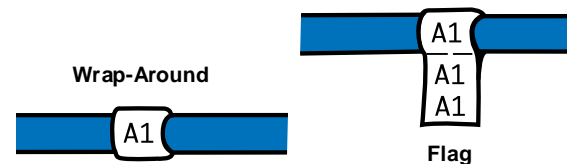

| Part Number | Label Code Half / Full | Width A In. (mm) | Length B In. (mm) | Normal Text | | Labels Per Roll | Std. Pkg. Qty.* |
|-------------|------------------------|------------------|-------------------|-----------------|---------------------|-----------------|-----------------|
| | | | | Lines Per Label | Characters Per Line | | |
| L3PCM36 | W107 / W207 | 1.50 (38.1) | 0.25 (6.4) | 3 / 6 | 1 | 500 | 1 Roll |
| L3PCM25 | W109 / W209 | 1.50 (38.1) | 0.36 (9.1) | 3 / 6 | 2 | 500 | |
| L3PCM18 | W113 / W213 | 1.50 (38.1) | 0.50 (12.7) | 3 / 6 | 4 | 500 | |

* Order number of rolls required in multiples of Std. Pkg. Qty.

Note: Based on printer manufacture date, firmware revision may be required to use these labels. Contact factory for upgrade information.

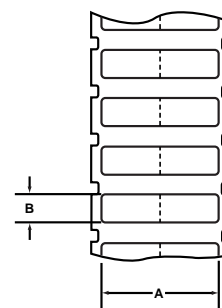

Wire Marker Labels

Self-Laminating Vinyl Wire Markers

- Designed to identify all sizes of wires and cables quickly and economically
- Clear overlamine protects legend
- Part numbers shown have white print-on area
- Multiple across labels available



| Part Number | Label Code | Total Area A x B In. (mm) | Print-On Area A x C In. (mm) | Normal Text‡ | | Outside Cable Diameter Range # In. (mm) | Labels Per Roll | Std. Pkg. Qty.* |
|---|------------|---------------------------------|------------------------------------|-----------------|---------------------|--|-----------------|-----------------|
| | | | | Lines Per Label | Characters Per Line | | | |
| Vinyl Material (Indoor Applications) | | | | | | | | |
| LWS-6 | 1310 | 0.50 x 0.75 (12.7 x 19.1) | 0.50 x 0.38 (12.7 x 9.5) | 2 | 4 | 0.12 - 0.12 (3.1 - 3.1) | 250 | 1 Roll |
| LWS-8 | 2510 | 0.50 x 0.75 (12.7 x 19.1) | 0.50 x 0.38 (12.7 x 9.5)• | 2 | 4 | | 500 | |
| LWS-7 | 2510 | 1.00 x 0.75 (25.4 x 19.1) | 1.00 x 0.38 (25.4 x 9.5) | 2 | 10 | | 250 | |
| LWS-4 | 1310 | 0.50 x 1.00 (12.7 x 25.4) | 0.50 x 0.38 (12.7 x 9.5) | 2 | 4 | 0.12 - 0.20 (3.1 - 5.1) | 250 | |
| LWS-5 | 2510 | 1.00 x 1.00 (25.4 x 25.4) | 1.00 x 0.38 (25.4 x 9.5) | 2 | 10 | | 250 | |
| LWS-1 | 1313 | 0.50 x 1.25 (12.7 x 31.8) | 0.50 x 0.50 (12.7 x 12.7) | 3 | 4 | 0.16 - 0.24 (4.1 - 6.1) | 250 | |
| LWS-9 | 2513 | 0.50 x 1.25 (12.7 x 31.8) | 0.50 x 0.50 (12.7 x 12.7)• | 3 | 4 | | 500 | |
| LWS-2† | 2513 | 1.00 x 1.25 (25.4 x 31.8) | 1.00 x 0.50 (25.4 x 12.7) | 3 | 10 | | 250 | |
| LWS-3 | 3813 | 1.50 x 1.25 (38.1 x 31.8) | 1.50 x 0.50 (38.1 x 12.7) | 3 | 16 | 250 | | |
| LWS-10† | 2519 | 1.00 x 2.50 (25.4 x 63.5) | 1.00 x 0.75 (25.4 x 19.1) | 5 | 10 | 0.24 - 0.56 (6.1 - 14.2) | 100 | |
| LWS-11 | 3819 | 1.50 x 2.50 (38.1 x 63.5) | 1.50 x 0.75 (38.1 x 19.1) | 5 | 16 | | 100 | |
| LWS-12† | 2525 | 1.00 x 4.00 (25.4 x 101.6) | 1.00 x 1.00 (25.4 x 25.4) | 7 | 10 | 0.32 - 0.95 (8.1 - 24.1) | 100 | |
| LWS-13 | 3825 | 1.50 x 4.00 (38.1 x 101.6) | 1.50 x 1.00 (38.1 x 25.4) | 7 | 16 | | 100 | |
| LWS-14 | 2525 | 1.00 x 6.00 (25.4 x 152.4) | 1.00 x 1.00 (25.4 x 25.4) | 7 | 10 | 0.32 - 1.59 (8.1 - 40.4) | 50 | |
| TEDLAR # Material (Indoor /Outdoor Applications) | | | | | | | | |
| LWS-54 | 2513 | 1.00 x 1.25 (25.4 x 31.8) | 1.00 x 0.50 (25.4 x 12.7) | 3 | 10 | 0.16 - 0.24 (4.1 - 6.1) | 250 | 1 Roll |

‡ Similar information for other text sizes provided in LS3E manual
 † Label available with colored print-on area. Colors may include YL for Yellow, RD for Red, BU for Blue, GR for Green, IG for Gray, OR for orange, PR for Purple and BR for Brown. To order, add appropriate suffix to part number. Contact factory for availability.
 • Denotes butt-cut label, 2 half-wide marker strips
 # TEDLAR is the registered trademark of E. I. DuPont Co.
 * Refer to Wire Size Selection Guide on page 196 to review diameters of commonly used cables
 * Order number of rolls required in multiples of Std. Pkg. Qty.



Standard



Butt-Cut

Wire Marker Labels

- Can be used as wrap-around or flag style markers
- Can also be used for component labeling
- Material: White Vinyl Cloth



| Part Number | Label Code | A Width In. (mm) | B Length In. (mm) | Normal Text‡ | | Labels Per Roll | Std. Pkg. Qty.* |
|-------------|------------|---------------------|----------------------|-----------------|---------------------|-----------------|-----------------|
| | | | | Lines Per Label | Characters Per Line | | |
| LW-4 | 1319 | 0.50 (12.7) | 0.75 (19.1) | 5 | 4 | 250 | 1 Roll |
| LW-6 | 2519 | 0.50 (12.7)• | 0.75 (19.1) | 5 | 4 | 500 | |
| LW-3 | 1325 | 0.50 (12.7) | 1.00 (25.4) | 7 | 4 | 250 | |
| LW-1 | 1332 | 0.50 (12.7) | 1.25 (31.8) | 9 | 4 | 250 | |
| LW-5 | 2532 | 0.50 (12.7)• | 1.25 (31.8) | 9 | 4 | 500 | |
| LW-2 | 2532 | 1.00 (25.4) | 1.25 (31.8) | 9 | 10 | 250 | |

‡ Similar information for other text sizes provided in LS3E manual
 • Denotes butt-cut label, 2 half-wide marker strips
 * Order number of rolls required in multiples of Std. Pkg. Qty.

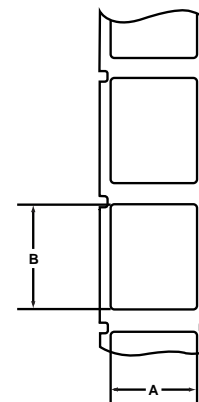

Standard

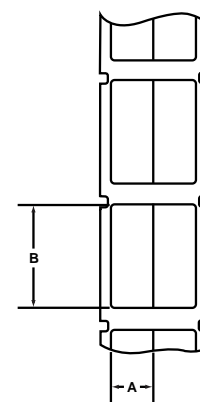

Butt-Cut

Heat Shrink Tubing for Permanent Wire and Cable Identification

- Service Temperature Range: -22°F to 220°F (-30°C to 105°C)
- Shrink Ratio: 3:1 @ 212°F (100°C)
- Flammability: Meets U.L. Standard 224 for flammability
- Material: Flattened Polyolefin
- Use with Panduit Heat Shrink Tools and Accessories shown on [page 25](#)

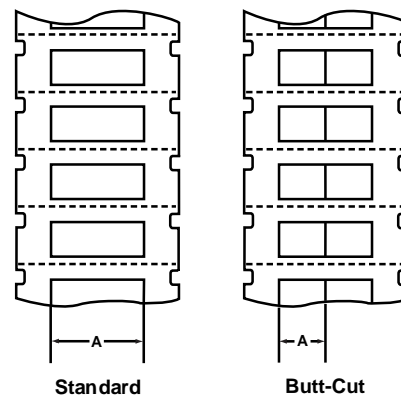
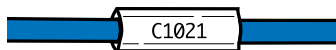

| Part Number | | Label Code | Width A In. (mm) | Markers Per Row | Outside Cable Diameter Range [■] In. (mm) | Normal Text [‡] | | Markers Per Roll | Std. Pkg. Qty.* |
|-------------|--------|------------|--------------------------|-----------------|--|--------------------------|---------------------|------------------|-----------------|
| White | Yellow | | | | | Lines Per Label | Characters Per Line | | |
| LHSW-1 | LHSY-1 | T206 | 0.50 (12.7) [•] | 2 | 0.04 - 0.13 (1.1 - 3.2) | 1 | 4 | 1 Roll | |
| LHSW-2 | LHSY-2 | T106 | 1.00 (25.4) | 1 | | 0.06 - 0.19 (1.6 - 4.8) | 1 | | |
| LHSW-6 | LHSY-6 | T208 | 0.50 (12.7) [•] | 2 | 0.08 - 0.25 (2.1 - 6.4) | | 2 | | |
| LHSW-7 | LHSY-7 | T108 | 1.00 (25.4) | 1 | | 0.17 - 0.50 (4.2 - 12.7) | 2 | | |
| LHSW-3 | LHSY-3 | T211 | 0.50 (12.7) [•] | 2 | | | 2 | | |
| LHSW-4 | LHSY-4 | T111 | 1.00 (25.4) | 1 | | | 2 | | |
| LHSW-5 | LHSY-5 | T121 | 1.00 (25.4) | 1 | | | 5 | | |

‡ Similar information for other text sizes provided in LS3E manual
 • Denotes butt-cut label, 2 half-wide marker strips
 ■ Refer to Wire Size Selection Guide on [page 196](#) to review diameters of commonly used cables
 * Order the number of rolls required in multiples of Std. Pkg. Qty.

Component Labels

- Available in a wide range of sizes
- Material: White Vinyl Cloth

| Part Number | Label Code | A Width In. (mm) | B Length In. (mm) | Color | Normal Text [‡] | | Labels Per Roll | Std. Pkg. Qty.* |
|-------------|------------|------------------|-------------------|-------|--------------------------|---------------------|-----------------|-----------------|
| | | | | | Lines Per Label | Characters Per Line | | |
| LC-6 | 1307 | 0.50 (12.7) | 0.28 (7.0) | White | 1 | 4 | 1 Roll | |
| LC-3 | 1313 | 0.50 (12.7) | 0.50 (12.7) | White | 3 | 4 | | |
| LC-7 | 2507 | 1.00 (25.4) | 0.28 (7.0) | White | 1 | 10 | | |
| LC-9 | 2510 | 1.00 (25.4) | 0.40 (10.2) | White | 2 | 10 | | |
| LC-10 | 2513 | 1.00 (25.4) | 0.50 (12.7) | White | 3 | 10 | | |
| LC-4 | 2519 | 1.00 (25.4) | 0.75 (19.1) | White | 5 | 10 | | |
| LC-2 | 2525 | 1.00 (25.4) | 1.00 (25.4) | White | 7 | 10 | | |
| LC-8 | 3807 | 1.50 (38.1) | 0.28 (7.0) | White | 1 | 16 | | |
| LC-11 | 3813 | 1.50 (38.1) | 0.50 (12.7) | White | 3 | 16 | | |
| LC-5 | 3819 | 1.50 (38.1) | 0.75 (19.1) | White | 5 | 16 | | |
| LC-1 | 3832 | 1.50 (38.1) | 1.25 (31.8) | White | 9 | 16 | | |

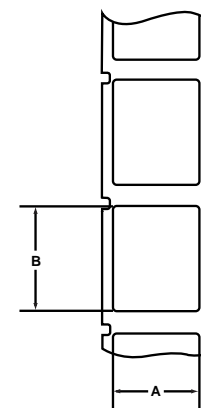

‡ Similar information for other text sizes provided in LS3E manual
 * Order number of rolls required in multiples of Std. Pkg. Qty.

Laminated Label

- Print and apply top white label and overlaminate with clear bottom label
- Material: GMV3 Vinyl

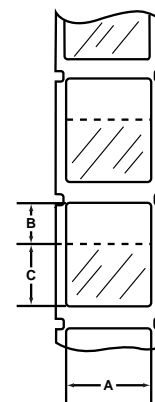

| Part Number | Label Code | Print-On Label Size A x B In. (mm) | Overlamine Label Size A x C In. (mm) | Normal Text‡ | | Labels/ Roll | Std. Pkg.* |
|-------------|------------|--|--|-----------------|---------------------|-----------------|------------|
| | | | | Lines Per Label | Characters Per Line | | |
| LWS-11P | 3819 | 1.50 x 0.75 (38 x 19) | 1.50 x 1.75 (38 x 25) | 5 | 16 | 100 | 1 Roll |

‡ Similar information using other text sizes available in LS3E Manual

* Order number of rolls required in multiples of Std. Pkg.

Terminal Block Labels

- Used to make on-demand terminal block label strips
- 35 ft. (10.7 m) continuous roll
- Material: White Vinyl Cloth

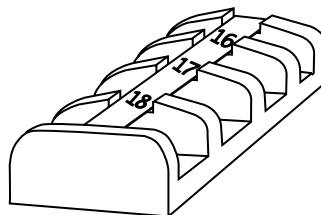

| Part Number | Label Code | Width A In. (mm) | Length B Ft. (m) | Labels Per Roll | Std. Pkg. Qty.* |
|-------------|------------|------------------------|------------------------|-----------------|-----------------|
| LC-14 | 0900 | 0.31 (7.9) | 35 ft. (10.7 m) | 1 | 1 Roll |
| LC-15 | 1000 | 0.38 (9.5) | 35 ft. (10.7 m) | 1 | |

* Order number of rolls required in multiples of Std. Pkg. Qty.

Asset / Quality Assurance Labels



LC-38



LC-39



LC-40



LC-41

| Part Number | Label Code | Width A In. (mm) | Length B In. (mm) | Material | Color (Legend/ Background) | Labels Per Roll | Std. Pkg. Qty.* |
|-------------|------------|------------------------|-------------------------|-------------|-------------------------------|-----------------|-----------------|
| LC-38 | 3611 | 1.50 (38.1) | 0.75 (19.1) | Polyester | Black/Silver | 250 | 1 Roll |
| LC-39 | 3811 | 1.50 (38.1) | 0.75 (19.1) | Vinyl Cloth | Green/White | 250 | |
| LC-40 | 3813 | 1.50 (38.1) | 0.75 (19.1) | Vinyl Cloth | Black/White | 250 | |
| LC-41 | 3617 | 1.50 (38.1) | 0.75 (19.1) | Polyester | Black/Silver | 250 | |

* Order number of rolls required in multiples of Std. Pkg. Qty.

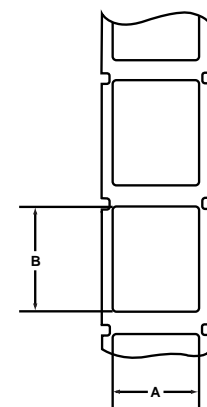

LS5 and LS5E Industrial Labeling Systems

Hand-held, portable labeling systems designed to meet the rugged demands of industrial labeling applications



Produces:

- Self-laminating labels and wire markers
- Continuous laminated tape including bar codes
- Non-laminated commercial tapes
- Heat shrink wire markers
- Tamper-evident labels
- Die-cut labels

Mechanical Information

| | |
|-------------------------------|--|
| Print Method: | Thermal transfer printing |
| Size: | Height: 4.5" H x 6.0" W x 11.5" D (114 mm x 152 mm x 292 mm) Weight: 4.7 lbs. (2.1 kg) with batteries |
| Graphics Resolution: | 203 dpi |
| Interface: | PCMCIA application card interface |
| Communications: | RS232 serial communication port |
| Display: | Two-line x 16 character display |
| Operating Temperature: | 32° to 104°F (0° to 40°C) |
| Power Source: | 6 C-Cell Ni-Cad batteries (Included) UL Listed, CSA Approved Power Adapter (Optional) |

Choose the System which best suits your application:

| | LS5 Printer Part Number: LS5-KIT | LS5 Data-Comm Printer Part Number: LS5-KITDC | LS5E Enhanced Printer Part Number: LS5E |
|--|---|---|---|
| Usable Memory | 16K | 16K | 450K |
| Inherent Bar Codes | Code 39, Code 128, Codabar, I 2 of 5, EAN 8, EAN 13, UPC A, UPC E | Code 39, Code 128, Codabar, I 2 of 5, EAN 8, EAN 13, UPC A, UPC E | Code 39, Code 128, Codabar, I 2 of 5, EAN 8, EAN 13, UPC A, UPC E, PDF417, MSI Plessey |
| Enhanced Printer Features | — | — | Time and Date Clock Tape Feed Control Annunciator |
| Prompting Languages | English, Spanish, French, German, Portuguese, Italian | English, Spanish, French, German, Portuguese, Italian | English, Spanish, French, German, Portuguese, Italian, Swedish, Danish, Dutch, Norwegian and Finish |
| Print Styles | Outline, Shadow, Underline, Bold, Frame, Italic, Mirror and Rotated | Outline, Shadow, Underline, Bold, Frame, Italic, Mirror and Rotated | Underline, Bold, Frame, Italic, Mirror and Rotated |
| Edit Feature | Yes | Yes | Yes |
| Alpha/Numeric Sequencing | Yes | Yes | Yes |
| Repeat 999 times | Yes | Yes | Yes |
| Left/Right/Center Justification | Yes | Yes | Yes |
| Scaling | Yes | Yes | Yes |
| Up to 6 Lines of Text | Yes | Yes | Yes |
| Data-Comm Templates | No | Yes | No |

Printers

| Part Number | Description | Std. Pkg. Qty.* |
|-------------|--|-----------------|
| LS5-KIT | Industrial Labeling System Kit: (Includes LS5 Printer, 6 C-Cell Ni-Cad Batteries, Ni-Cad Battery Charger, one LS5-33 Laminated 1" Industrial Tape Cartridge, 8 resident bar code fonts) | 1 |
| LS5-KITDC | Data-Comm Labeling System Kit: same components as LS5-KIT above, plus preloaded with Data-Comm Label Formats | |
| LS5E | Enhanced Industrial Labeling System Kit: (Includes LS5E Printer, 6 C-Cell Ni-Cad Batteries, Ni-Cad Battery Charger, one LS5-33 Laminated 1" Industrial Tape Cartridge, one 9 pin null modem cable, 10 resident bar code fonts) | 1 |

PANDUIT® LS5 and LS5E Industrial Portable Labeling Systems

Accessories

| Part Number | Description | Std. Pkg. Qty.* |
|-------------|---|-----------------|
| LS5-1 | Replacement Battery Charger | 1 |
| LS5-2 | Soft Sided Carrying Case (Optional) | 1 |
| LS5-3 | Hand Strap (Optional) | 1 |
| LS5-60 | AC Power Supply (Optional) | 1 |
| LS5-DCT | Data-Comm Templates Disk and 9-pin null modem cable | 1 |

| Part Number | Description | Std. Pkg. Qty.* |
|-------------|--|-----------------|
| LS5-D | WINDOWS [®] Driver Disk (Optional) For WINDOWS 3.1, 3.11 and 95 | 1 |
| PTR-CLN | Printer Cleaning Kit; Contains 4 oz. (116 ml) bottle cleaning solution with MSDS, cleaning pen, 100 swabs, 12 alcohol wipes and instructions | 1 |

*Order number of pieces required in multiples of Std. Pkg. Qty.
[^] WINDOWS is a registered trademark of Microsoft Corporation

Selecting the Correct Font Size

The charts below show the Font Point Size to use based on the tape or tubing size used and lines of text desired:

| Tape Width In. (mm) | Lines of Text | | | | | |
|------------------------|---------------|---------|---------|---------|---------|---------|
| | 1 Line | 2 Lines | 3 Lines | 4 Lines | 5 Lines | 6 Lines |
| 0.50 (12.7) | 30 pt | 14 pt | 8 pt | 6 pt | — | — |
| 0.80 (20.3) | 55 pt | 24 pt | 16 pt | 12 pt | 9 pt | 7 pt |
| 1.00 (25.4) | 72 pt | 33 pt | 21 pt | 16 pt | 12 pt | 10 pt |

| Tubing Diameter In. (mm) | Lines of Text | | | | | |
|-----------------------------|---------------|---------|---------|---------|---------|---------|
| | 1 Line | 2 Lines | 3 Lines | 4 Lines | 5 Lines | 6 Lines |
| 0.25 (6.4) | 24 pt | 10 pt | 6 pt | — | — | — |
| 0.38 (9.5) | 36 pt | 16 pt | 10 pt | 8 pt | 6 pt | — |
| 0.50 (12.7) | 46 pt | 20 pt | 13 pt | 10 pt | 7 pt | 6 pt |

Laminated Industrial Tape Cartridges

- Laminated Industrial Tape is designed for tough jobs and can withstand extremes of heat and cold, resist abrasion, UV light exposure, and the most commonly used chemicals and solvent

| Part Number | Tape Width In. (mm) | Tape Length Ft. (m) | Legend/ Background Color | Std. Pkg. Qty.* |
|-------------|------------------------|------------------------|--------------------------------|-----------------|
| LS5-530 | 0.50 (12.7) | 40 (12.2) | Black/Clear | 1 |
| LS5-533 | | | Black/White | 1 |
| LS5-535 | | | Red/White | 1 |
| LS5-537 | | | Black/Red | 1 |
| LS5-538 | | | Black/Yellow | 1 |
| LS5-544 | | | White/Black | 1 |
| LS5-547 | | | White/Blue | 1 |
| LS5-548 | | | White/Red | 1 |
| LS5-70 | | | 0.80 (20.3) | 40 (12.2) |
| LS5-72 | Red/Clear | 1 | | |
| LS5-73 | Black/White | 1 | | |
| LS5-74 | Blue/White | 1 | | |
| LS5-75 | Red/White | 1 | | |
| LS5-77 | Black/Red | 1 | | |
| LS5-78 | Black/Yellow | 1 | | |
| LS5-79 | Black/Green | 1 | | |
| LS5-82 | White/Clear | 1 | | |
| LS5-87 | White/Blue | 1 | | |
| LS5-88 | White/Red | 1 | | |
| LS5-89 | White/Green | 1 | | |
| LS5-90 | Black/Orange | 1 | | |

| Part Number | Tape Width In. (mm) | Tape Length Ft. (m) | Legend/ Background Color | Std. Pkg. Qty.* |
|-------------|------------------------|------------------------|--------------------------------|-----------------|
| LS5-30 | 1.00 (25.4) | 40 (12.2) | Black/Clear | 1 |
| LS5-32 | | | Red/Clear | 1 |
| LS5-33 | | | Black/White | 1 |
| LS5-34 | | | Blue/White | 1 |
| LS5-35 | | | Red/White | 1 |
| LS5-37 | | | Black/Red | 1 |
| LS5-38 | | | Black/Yellow | 1 |
| LS5-39 | | | Black/Green | 1 |
| LS5-42 | | | White/Clear | 1 |
| LS5-44 | | | White/Black | 1 |
| LS5-47 | | | White/Blue | 1 |
| LS5-48 | | | White/Red | 1 |
| LS5-49 | | | White/Green | 1 |
| LS5-50 | | | Black/Orange | 1 |

*Order number of cartridges required in multiples of Std. Pkg. Qty.

Laminated Tamper-Evident Tape Cartridge

| Part Number | Tape Width In. (mm) | Tape Length Ft. (m) | Legend/ Background Color | Std. Pkg. Qty.* |
|-------------|------------------------|------------------------|--------------------------------|-----------------|
| LS5-33T | 1.00 (25.4) | 40 (12.2) | Black/White | 1 |

*Order number of cartridges required in multiples of Std. Pkg. Qty.

PANDUIT® LS5 and LS5E Industrial Portable Labeling Systems

- Non-Laminated Commercial Tape Supply is designed for indoor applications where abrasion and chemical resistance are not required.

Non-Laminated Commercial Tape Cartridge

| Part Number | Tape Width In. (mm) | Tape Length Ft. (m) | Legend/Background Color | Std. Pkg. Qty.* |
|-------------|---------------------|---------------------|-------------------------|-----------------|
| LS5-30C | 1.00 (25.4) | 4.00 (12.2) | Black/Clear | 1 |
| LS5-33C | | | Black/White | 1 |
| LS5-35C | | | Red/White | 1 |
| LS5-38C | | | Black/Yellow | 1 |



Electronic Component Labeling

Die-Cut Label Cartridges

| Part Number | Material | Color | Label Size Width x Length In. (mm) | Labels/Cartridge | Std. Pkg. Qty.* |
|-------------|-----------------|-------|---|------------------|-----------------|
| LS5-17 | Polyester | White | 0.50 x 1.00 (12.7 x 25.4) | 174 | 1 |
| LS5-18 | Polyester | White | 0.66 x 3.44 (16.8 x 87.4) File Folder Size | 92 | 1 |
| LS5-19 | Synthetic Paper | White | 0.66 x 3.44 (16.8 x 87.4) File Folder Size | 92 | 1 |
| LS5-20 | Synthetic Paper | White | 1.00 x 4.00 (25.4 x 101.6) | 82 | 1 |



Marking Wires and Cables

Self-Laminating Wire Marker Cartridges

| Part Number | Material | Print-On Area Color | Label Size Width x Length In. (mm) | Print-On Area Width x Length In. (mm) | Nominal Cable O.D. # In. (mm) | Labels/Cartridge | Std. Pkg. Qty.* |
|-------------|---------------------|---------------------|------------------------------------|---------------------------------------|-------------------------------|------------------|-----------------|
| LS5-11 | Vinyl | White | 1.00 x 0.75 (25.4 x 19.1) | 1.00 x 0.38 (25.4 x 9.5) | 0.12 - 0.12 (3.1 - 3.1) | 200 | 1 |
| LS5-12 | TEDLAR [▲] | White | 1.00 x 0.75 (25.4 x 19.1) | 1.00 x 0.38 (25.4 x 9.5) | | 200 | 1 |
| LS5-13 | Vinyl | White | 1.00 x 1.25 (25.4 x 31.8) | 1.00 x 0.50 (25.4 x 12.7) | 0.16 - 0.24 (4.1 - 6.1) | 160 | 1 |
| LS5-14 | TEDLAR | White | 1.00 x 1.25 (25.4 x 31.8) | 1.00 x 0.50 (25.4 x 12.7) | | 160 | 1 |
| LS5-15 | Vinyl | White | 1.00 x 2.50 (25.4 x 63.5) | 1.00 x 0.75 (25.4 x 19.1) | 0.24 - 0.56 (6.1 - 14.2) | 110 | 1 |
| LS5-16 | TEDLAR | White | 1.00 x 2.50 (25.4 x 63.5) | 1.00 x 0.75 (25.4 x 19.1) | | 110 | 1 |
| LS5-10 | Vinyl | White | 1.00 x 4.00 (25.4 x 101.6) | 1.00 x 1.00 (25.4 x 25.4) | 0.32 - 0.95 (8.1 - 24.1) | 83 | 1 |

[▲]TEDLAR is a registered trademark of E.I. DuPont Co.

*Refer to Wire Size Selection Guide on [page 196](#) to review diameters of commonly used cables



Flattened Polyolefin Heat Shrink Tubing Supply Cartridges

| Part Number | Diameter In. (mm) | Nominal Cable O.D. # In. (mm) | Color | Length In. (mm) | Std. Pkg. Qty.* |
|-------------|-------------------|-------------------------------|--------------|-----------------|-----------------|
| LS5-HS3 | 0.25 (6.4) | 0.08 - 0.25 (2.1 - 6.4) | Black/White | 100 (2540) | 1 |
| LS5-HS4 | 0.38 (9.5) | 0.13 - 0.38 (3.2 - 9.5) | | | 1 |
| LS5-HS5 | 0.50 (12.7) | 0.17 - 0.50 (4.2 - 12.7) | | | 1 |
| LS5-HS8 | 0.25 (6.4) | 0.08 - 0.25 (2.1 - 6.4) | Black/Yellow | 100 (2540) | 1 |
| LS5-HS9 | 0.38 (9.5) | 0.13 - 0.38 (3.2 - 9.5) | | | 1 |
| LS5-HS10 | 0.50 (12.7) | 0.17 - 0.50 (4.2 - 12.7) | | | 1 |

*Refer to Wire Size Selection Guide on [page 196](#) to review diameters of commonly used cables

- Service Temperature Range: -22°F to 220°F (-30°C to 105°C)
- Shrink Ratio 3:1 @ 212°F (100°C)
- Flammability: Meets U.L. Standard 224 for flammability

See [page 25](#) for Heat Shrink Tools and Accessories

LS4H Heat Shrink Tube Marking System

High performance, self-contained marking system that produces heat shrink tube markers for wire and cable identification and laminated component markers.



- Provides durable, high quality permanent tube markers
- Indestructible 3:1 flattened polyolefin heat shrink tubing cartridge meets UL-224 requirements
- Laminated tape cartridge supplies built in thermal transfer ribbon that prints up to four sizes of text on 0.50" (12.7mm) wide adhesive tape
- Can also be powered by 4 D-Cell Ni-Cad batteries in locations where power is not available

Printer Features

- Prints in 4 standard font sizes: 8, 10, 12, and 16 point Helvetica
- Prints in **bold type** or underline text for positive identification of numbers
- Prints markers either horizontally or vertically
- Scratch resistant marking
- Repeat legend up to 99 times, eliminating the need to re-key repetitive information
- Automatic alpha and numeric sequencing saves time
- Legend can be centered automatically on tube size selected



Vertical and underlining capability



Automatic Sequencing



Repeat for short runs



Scratch resistant marking

Printer and Accessories

| Part Number | Description | Std. Pkg.* |
|-------------|---|------------|
| LS4H | Heat Shrink Tube Marker Kit: Includes LS4H Printer, 115 VAC Power Adaptor, one black / white cartridge 0.19" (4.8mm) tubing, and one black / white cartridge 0.25"(6.4mm) tubing | 1 |
| LS4-60 | Replacement 115 VAC Power Adaptor | 1 |
| LS4-53 | Ni-Cad Battery Charger (Optional) | 1 |
| LS4H-7 | Black Carrying Case (Optional) | 1 |
| LS4H-9 | Scissors (Optional) | 1 |

Laminated Industrial Supply Cartridges

| Part Number | Width In. (mm) | Length Ft. (m) | Color | Std. Pkg.* |
|-------------|----------------|----------------|--------------|------------|
| LS4H-30I | 0.50 (12.7) | 50 (15.2) | Black/Clear | 1 |
| LS4H-33I | 0.50 (12.7) | 50 (15.2) | Black/White | 1 |
| LS4H-37I | 0.50 (12.7) | 50 (15.2) | Black/Red | 1 |
| LS4H-38I | 0.50 (12.7) | 50 (15.2) | Black/Yellow | 1 |

Heat Shrink Tubing Supply Cartridges

- Material: Flattened Polyolefin
- Shrink ratio 3:1 @ 212°F (100°C)
- Flammability: Meets U.S. Standard 224 for flammability
- Used with Panduit Heat Shrink Tools and Accessories shown on [page 25](#)

| Part Number | Diameter In. (mm) | Nominal Cable O.D. In. (mm) | Length In. (mm) | Color | Std. Pkg.* |
|-------------|-------------------|-----------------------------|-----------------|--------------|------------|
| LS4H-1 | 0.13 (3.2) | 0.04 - 0.13 (1.1 - 3.2) | 100 (2540) | Black/White | 1 |
| LS4H-2 | 0.19 (4.8) | 0.06 - 0.19 (1.6 - 4.8) | 100 (2540) | | 1 |
| LS4H-3 | 0.25 (6.4) | 0.08 - 0.25 (2.1 - 6.4) | 100 (2540) | | 1 |
| LS4H-4 | 0.13 (3.2) | 0.04 - 0.13 (1.1 - 3.2) | 100 (2540) | Black/Yellow | 1 |
| LS4H-5 | 0.19 (4.8) | 0.06 - 0.19 (1.6 - 4.8) | 100 (2540) | | 1 |
| LS4H-6 | 0.25 (6.4) | 0.08 - 0.25 (2.1 - 6.4) | 100 (2540) | | 1 |

*Order number of Std. Pkgs. required in multiples of Std. Pkg. Qty.

LS4M Multiple Line Portable Labeling System

High performance, self-contained labeling system that prints up to four lines of text on 0.50" (12.7 mm) wide adhesive tape.



- Laminated, adhesive backed polyester tape is heat and scratch resistant, supplied in convenient cartridges
- Label cartridges feature built-in thermal transfer ribbon, overlamine and cutter for trouble-free performance
- Indestructible polyester laminate insures no loss of readability
- Compact, portable size allows usage anywhere
- Use with AC Power Adapter (included) or four Ni-Cad batteries (not included)

Printer Features

- Prints in 3 standard font sizes 6, 8, and 12 point Helvetica
- Prints in bold, outline, vertical, negative image, mirror image, shadow and underline
- Prints marker either horizontally or vertically
- Automatic alpha and numeric sequencing
- Prints up to 15 characters per second
- Text may be scaled 2X for larger more legible print
- 16-character display screen allows text verification prior to printing
- Prints from 1-4 lines on single strip of tape



Circuit board labeling



Label switches, relays and other devices



Telecommunications labeling



Inventory and bin-marking

Printer and Accessories

| Part Number | Description | Std. Pkg.* |
|-------------|---|------------|
| LS4M | Multiple Line Labeling System (Includes AC Power Adapter, batteries not included) | 1 |
| LS4-60 | Replacement 115 VAC Power Adapter | 1 |
| LS4-53 | Ni-Cad Battery Charger (Optional) | 1 |
| LS4-54 | 3 of 9 Bar Code Font Card (Optional) | 1 |
| LS4-57 | 6 point Helvetica Regular Font Card (Optional) | 1 |
| LS4-58 | 18 point Helvetica Regular Font Card (Optional) | 1 |
| LS4-59 | 36 point Helvetica Regular Font Card (Optional) | 1 |
| LS4H-7 | Black Carrying Case (Optional) | 1 |

LS4M Industrial Labeling Tape (Heavy duty, outdoor)

- Withstand extremes of heat and cold, resist abrasion, UV light exposure, and the most commonly used chemicals and solvents.

| Part Number | Width In. (mm) | Length Ft. (m) | Color | Std. Pkg.* |
|-------------|----------------|----------------|--------------|------------|
| LS4-30I | 0.50 (12.7) | 50 (15.2) | Black/Clear | 1 |
| LS4-33I | | | Black/White | 1 |
| LS4-38I | | | Black/Yellow | 1 |
| LS4-42I | | | White/Clear | 1 |
| LS4-44I | | | White/Black | 1 |

Standard Labeling Tapes

- Designed for indoor applications where abrasion and chemical resistance are not required

| Part Number | Width In. (mm) | Length Ft. (m) | Color | Std. Pkg.* |
|-------------|----------------|----------------|--------------|------------|
| LS4-30 | 0.50 (12.7) | 50 (15.2) | Black/Clear | 1 |
| LS4-31 | | | Blue/Clear | 1 |
| LS4-32 | | | Red/Clear | 1 |
| LS4-33 | | | Black/White | 1 |
| LS4-34 | | | Blue/White | 1 |
| LS4-35 | | | Red/White | 1 |
| LS4-36 | | | Black/Blue | 1 |
| LS4-37 | | | Black/Red | 1 |
| LS4-38 | | | Black/Yellow | 1 |
| LS4-39 | | | Black/Green | 1 |
| LS4-42 | | | White/Clear | 1 |
| LS4-43 | | | Green/White | 1 |
| LS4-44 | | | White/Black | 1 |
| LS4-45 | | | Black/Silver | 1 |
| LS4-46 | | | Black/Gold | 1 |
| LS4-47 | | | White/Blue | 1 |
| LS4-48 | | | White/Red | 1 |
| LS4-49 | | | White/Green | 1 |
| LS4-50 | | | Black/Orange | 1 |

PTR1 Flat-Bed, Dot-Matrix Printer



Produces Custom Markers Instantly!

- Use with Panduit Dot-Matrix and Heat Shrink labels
- Use with Panduit **ON-DEMAND™** Wire Marker Cards
- Provides excellent print quality and sharp, permanent characters
- Adjustable print head gap eliminates smearing, especially on thick material
- Straight label path eliminates the potential for jamming or peeling of labels
- Durable rugged metal construction is ideal for industrial environments
- Compatible with **PAN-MARK™** for **WINDOWS^ 2.X** or higher, **PAN-MARK LT** and **PROG-LITE** Labeling Software Programs (see [pages 27-32](#) for complete software product information).

Mechanical Information

Print Method: 24-pin dot-matrix print head

Size:

| | | |
|---------|---------|----------|
| Height: | 4.8" | (122 mm) |
| Width: | 15.1" | (384 mm) |
| Depth: | 7.5" | (190 mm) |
| Weight: | 10 lbs. | (4.5 kg) |

Print Speed: Draft: 166 Characters Per Second
Near Letter Quality: 83 Characters Per Second

Print Buffer: 8 KB

Graphics Horizontal: 180 dpi

Resolution: Vertical: 120 dpi

Forms Control: Adjustable width tractors accommodate 1.50" (38.1 mm) to 10.25" (260.3 mm) width pinfeed forms

Interface and Communications: Centronics parallel 36 pin and DB25 (RS232) serial interface

Ribbon Width: 0.50" (12.7 mm)

Voltage: Autoranging 115 VAC +/- 10% to 230 VAC +/- 10%

Fuse: 1 Amp Fast-Blow for 115/230 VAC

| Part Number | Description | Std. Pkg. Qty.* |
|-------------|--|-----------------|
| PTR1 | Dot-Matrix Printer Kit (Includes Printer, AC Power Cord, Operator Manual and Indelible Ribbon) | 1 |
| PTR1-AC | Replacement AC Power Cord up to 115V | 1 |
| PTR1-AC220 | Replacement AC Power Cord up to 220V | 1 |
| PTR1-RIB | Replacement Indelible Ink Ribbon | 1 |
| PTR1-STD | Standard Ink Ribbon (Optional) | 1 |
| PTR1-MAN | Replacement PTR1 Operating Manual | 1 |
| PTR-CLN | Printer Cleaning Kit Contains 4 oz. (116 ml) bottle cleaning solution with MSDS, cleaning pen, 100 swabs, 12 alcohol wipes and instructions | 1 |

*Order number of printers or accessories required in multiples of Std. Pkg. Qty.

^WINDOWS is a registered trademark of Microsoft Corp.

Computer Printable Heat Shrink Tubing for Permanent Wire and Cable Identification



- Pre-cut tubing mounted on pin-fed plastic carrier
- Material: Flattened Polyolefin
- Service Temperature Range: -22°F to 220°F (-30°C to 105°C)
- Shrink Ratio 3:1 @ 212°F (100°C)
- Flammability: Meets U.L. Standard 224 for flammability
- Use with Panduit Heat Shrink Tools and Accessories shown on [page 25](#)

| Part Number | Diameter In. (mm) | Marker Width In. (mm) | Markers Per Row | Nominal Cable Outside Diameter [■] In. (mm) | Carrier Width In. (mm) | Color | Markers Per Roll | Std. Pkg. Qty.* |
|-------------|-------------------|-----------------------|-----------------|--|------------------------|-------|------------------|-----------------|
| LHS12W1 | 0.13 (3.2) | 2.00 (50.8) | 1 | 0.04 - 0.13 (1.1 - 3.2) | 3.50 (88.9) | White | 500 | 1 |
| LHS12W2 | 0.13 (3.2) | 1.00 (25.4) | 2 | | | | 1000 | 1 |
| LHS12W4 | 0.13 (3.2) | 0.50 (12.7) | 4 | | | | 2000 | 1 |
| LHS18W1 | 0.18 (4.8) | 2.00 (50.8) | 1 | 0.06 - 0.18 (1.6 - 4.8) | | | 500 | 1 |
| LHS18W2 | 0.18 (4.8) | 1.00 (25.4) | 2 | | | | 1000 | 1 |
| LHS18W4 | 0.18 (4.8) | 0.50 (12.7) | 4 | | | | 2000 | 1 |
| LHS25W1 | 0.25 (6.4) | 2.00 (50.8) | 1 | 0.08 - 0.25 (2.1 - 6.4) | | | 500 | 1 |
| LHS25W2 | 0.25 (6.4) | 1.00 (25.4) | 2 | | | | 1000 | 1 |
| LHS25W4 | 0.25 (6.4) | 0.50 (12.7) | 4 | | | | 2000 | 1 |
| LHS50W1 | 0.50 (12.7) | 2.00 (50.8) | 1 | 0.17 - 0.50 (4.2 - 12.7) | | | 500 | 1 |
| LHS50W2 | 0.50 (12.7) | 1.00 (25.4) | 2 | | | | 1000 | 1 |
| LHS12Y1 | 0.13 (3.2) | 2.00 (50.8) | 1 | 0.04 - 0.13 (1.1 - 3.2) | | | 3.50 (88.9) | Yellow |
| LHS12Y2 | 0.13 (3.2) | 1.00 (25.4) | 2 | | 1000 | 1 | | |
| LHS12Y4 | 0.13 (3.2) | 0.50 (12.7) | 4 | | 2000 | 1 | | |
| LHS18Y1 | 0.18 (4.8) | 2.00 (50.8) | 1 | 0.06 - 0.18 (1.6 - 4.8) | 500 | 1 | | |
| LHS18Y2 | 0.18 (4.8) | 1.00 (25.4) | 2 | | 1000 | 1 | | |
| LHS18Y4 | 0.18 (4.8) | 0.50 (12.7) | 4 | | 2000 | 1 | | |
| LHS25Y1 | 0.25 (6.4) | 2.00 (50.8) | 1 | 0.08 - 0.25 (2.1 - 6.4) | 500 | 1 | | |
| LHS25Y2 | 0.25 (6.4) | 1.00 (25.4) | 2 | | 1000 | 1 | | |
| LHS25Y4 | 0.25 (6.4) | 0.50 (12.7) | 4 | | 2000 | 1 | | |
| LHS50Y1 | 0.50 (12.7) | 2.00 (50.8) | 1 | 0.17 - 0.50 (4.2 - 12.7) | 500 | 1 | | |
| LHS50Y2 | 0.50 (12.7) | 1.00 (25.4) | 2 | | 1000 | 1 | | |

[■]Refer to Wire Size Selection Guide on [page 196](#) to review diameters of commonly used cables

*Order number of rolls required in multiples of Std. Pkg. Qty

For information on our complete line of Dot-Matrix Labels and Data Plates that can be used with the PTR1 Dot-Matrix Printer, see [pages 80-125](#).

ON-DEMAND™ Wire Marker Cards for Standard and Custom Wire Markers



Marker card rolls make the process easy. Simply create the custom legend using **PROG-LITE** Label Printing Software...



...print using the PTR1 Printer and tear off the plastic liner. Your custom card is ready to go!

BLANK CLOTH MARKER (Perforated to provide half markers)



36 Markers Per Card



33 Markers Per Card



25 Markers Per Card



20 Markers Per Card



18 Markers Per Card

| Part Number | Material | Markers Per Card | Print-On Area Width x Length In. (mm) | Total Marker Size Width x Length In. (mm) | Characters Per Line Per Marker† | Std. Pkg. Qty* |
|-------------|--------------------|------------------|---------------------------------------|---|---------------------------------|----------------|
| PCM36R-TL | White Vinyl Cloth | 36 | 0.25 x 1.50 (6.4 x 38.1) | 0.25 x 1.50 (6.4 x 38.1) | 1 to 2 | 250 |
| PCM33R-TL | | 33 | 0.27 x 1.50 (6.9 x 38.1) | 0.27 x 1.50 (6.9 x 38.1) | 1 to 2 | 250 |
| PCM25R-TL | | 25 | 0.36 x 1.50 (9.1 x 38.1) | 0.36 x 1.50 (9.1 x 38.1) | 1 to 3 | 250 |
| PCM20R-TL | | 20 | 0.45 x 1.50 (11.3 x 38.1) | 0.45 x 1.50 (11.3 x 38.1) | 1 to 4 | 250 |
| PCM18R-TL | | 18 | 0.50 x 1.50 (12.6 x 38.1) | 0.50 x 1.50 (12.6 x 38.1) | 1 to 5 | 250 |
| PCM36RY-TL | Yellow Vinyl Cloth | 36 | 0.25 x 1.50 (6.4 x 38.1) | 0.25 x 1.50 (6.4 x 38.1) | 1 to 2 | 250 |
| PCM33RY-TL | | 33 | 0.27 x 1.50 (6.9 x 38.1) | 0.27 x 1.50 (6.9 x 38.1) | 1 to 2 | 250 |
| PCM25RY-TL | | 25 | 0.36 x 1.50 (9.1 x 38.1) | 0.36 x 1.50 (9.1 x 38.1) | 1 to 3 | 250 |
| PCM20RY-TL | | 20 | 0.45 x 1.50 (11.3 x 38.1) | 0.45 x 1.50 (11.3 x 38.1) | 1 to 4 | 250 |
| PCM18RY-TL | | 18 | 0.50 x 1.50 (12.6 x 38.1) | 0.50 x 1.50 (12.6 x 38.1) | 1 to 5 | 250 |

*Order number of cards required in multiples of Std. Pkg. Qty.
 To order 100 cards/roll substitute "-C" for "-TL" in the above part numbers.
 For example PCM36R-TL = 250 cards/roll. PCM36R-C = 100 cards/roll.
 † Print 6 lines of identical information on each individual full size cloth marker.
 Print 3 lines of identical information on each half size cloth marker.

See [page 30](#) for information on **PROG-LITE** Labeling Software to generate **ON-DEMAND** Marker Cards

DURA-MARK™ PTR2 Thermal Transfer Printer And Accessories



Create a variety of high quality, custom labels

- *It's Quick!* — Custom capability allows labels to be produced in-house, anytime, anywhere.
- Choose from an assortment of colored thermal transfer rolls, self-laminating wire markers, blank labels and heat shrink markers shown on **pages 21-25**.
- Print legends up to 3.5" (89 mm) high.
- Works with most standard PC's and label printing software including Panduit® **PAN-MARK™ 2.X** or higher for **WINDOWS^** Label Printing Software (See **page 28** for complete software information).

Mechanical Information

Print Method: Thermal transfer and direct thermal printing

Size:
 Height: 5.3" (135 mm)
 Width: 7.9" (200 mm)
 Depth: 8.9" (226 mm)
 Weight: 4 lbs. (1.8 kg)

Print Speed: Select constant print speeds of 1", 1.5" or 2" (25.4, 38.1, or 50.8 mm) per second

Media:
 Roll Width: 1.1" - 4.6" (28 mm - 118 mm)
 Max. Roll Diameter: 3.8" (96 mm)
 Core Diameter: 1.0" (25 mm)
Use PTR2-RS Roll Stand for rolls with a core diameter > 1.0" (25 mm)

Memory: 128 Kb Standard

Double Buffer: Contains a double buffer which makes the printer capable of printing continuously from WINDOWS

Sensors: See through sensor designed for die-cut labels

Graphics Resolution: Up to 203 dpi

Print Information

- Fonts can be printed in four directions: 0°, 90°, 180° and 270°
- Capable of reverse print, bar coding and graphics
- Prints up to 32" (813 mm) length x 3.5" (89 mm) high characters
- 4.09" (104 mm) maximum print width
- Capable of horizontal and vertical print

| Part Number | Description | Std. Pkg. Qty* |
|-------------|--|----------------|
| PTR2 | Thermal Transfer Printer | 1 |
| PTR2-RS | External Label Roll Stand <i>Used to rear feed labels that are not supplied on 1.00" (25.4 mm) cores</i> | 1 |
| PTR-CLN | Printer Cleaning Kit Contains 4 oz. (116 ml) bottle cleaning solution with MSDS, cleaning pen, 100 swabs, 12 alcohol wipes and instructions | |

*Order number required in multiples of Std. Pkg. Qty.

^WINDOWS is a trademark of Microsoft Corp.

PTR2 Ribbons and Continuous Roll Supplies

Thermal Transfer Ribbons

| Part Number | Material | Size Width x Length | Use | Color | Std. Pkg. Qty* |
|-------------|----------|----------------------------------|---|-------|----------------|
| TTR-BL | Resin | 4.33" x 280' (110.0 mm x 85.3 m) | Vinyl and Polyester Applications | Black | 1 |
| TTR2-BL | Resin | 2.50" x 280' (63.5 mm x 85.3 m) | | Black | 1 |
| TTR-WH | Resin | 4.33" x 262' (110.0 mm x 79.8 m) | | White | 1 |
| TTR2-WH | Resin | 2.50" x 262' (63.5 mm x 79.8 m) | | White | 1 |
| TTRW-BL | Wax | 4.33" x 280' (110.0 mm x 85.3 m) | Self-Laminating Labels, Heat Shrink Labels and Paper Labels | Black | 1 |
| TTRW2-BL | Wax | 2.50" x 280' (63.5 mm x 85.3 m) | | Black | 1 |

*Order number of ribbons required in multiples of Std. Pkg. Qty.

Roll Material Selection Guide

| Material Type | Temperature Range | Key Feature | Color | Outdoor Rated | Hazardous Environment | UL Rec. | CSA |
|---------------|------------------------------|---|---|---------------|-----------------------|---------|-----|
| TTPA Paper | -65° to 160°F (-54° to 71°C) | Standard paper material for general indoor labeling | White | No | No | No | No |
| TTV Vinyl | -40° to 176°F (-40° to 80°C) | Conformable material for flat applications in indoor or outdoor environments. Can be overlaminated with clear polyester material to increase durability | White Yellow Red Green Blue Orange | Yes, 2 years | No | No | No |
| TTP Polyester | 0° to 275°F (-18° to 135°C) | TTP2-CLR/TTP4-CLR are used to produce markers with a clear background; TTP2-LAM/TTP4-LAM are used as an overlaminate to increase durability of vinyl or paper markers | Clear | Yes, 2 years | No | No | No |



2" (50.8 mm) Wide Rolls

| Part Number | Description | Roll Width In. (mm) | Roll Length Ft. (m) | Color | Material | Std. Pkg. Qty* |
|--|-----------------------|---------------------|---------------------|---|-------------------------|----------------|
| TTP2-CLR | Thermal Transfer Roll | 2.00 (50.8) | 100 (30.5) | Clear | Polyester | 1 |
| TTV2-WHT TTV2-YEL TTV2-RED TTV2-GRN TTV2-BLU TTV2-ORG | Thermal Transfer Roll | 2.00 (50.8) | 100 (30.5) | White Yellow Red Green Blue Orange | Vinyl | 1 |
| TTPA2-WHT | Thermal Transfer Roll | 2.00 (50.8) | 125 (38.1) | White | Paper | 1 |
| TTP2-LAM | Overlaminated Roll | 2.25 (57.1) | 100 (30.5) | Clear | Polyester Overlaminated | 1 |

Rolls are on 1.00" (25.4 mm) cores

*Order number of rolls required in multiples of Std. Pkg. Qty



4" (101.6 mm) Wide Rolls

| Part Number | Description | Roll Width In. (mm) | Roll Length Ft. (m) | Color | Material | Std. Pkg. Qty* |
|--|-----------------------|---------------------|---------------------|---|-------------------------|----------------|
| TTP4-CLR | Thermal Transfer Roll | 4.00 (101.6) | 100 (30.5) | Clear | Polyester | 1 |
| TTV4-WHT TTV4-YEL TTV4-RED TTV4-GRN TTV4-BLU TTV4-ORG | Thermal Transfer Roll | 4.00 (101.6) | 100 (30.5) | White Yellow Red Green Blue Orange | Vinyl | 1 |
| TTPA4-WHT | Thermal Transfer Roll | 4.00 (101.6) | 125 (38.1) | White | Paper | 1 |
| TTP4-LAM | Overlaminated Roll | 4.25 (108.0) | 100 (30.5) | Clear | Polyester Overlaminated | 1 |

Rolls are on 1.00" (25.4 mm) cores

*Order number of rolls required in multiples of Std. Pkg. Qty.



PTR2 Self-Laminating Labels



- Designed to identify all sizes of wires and cables quickly and economically
- Overlaminates protects legends for clear, permanent identification
- Available in a variety of sizes and 9 colors
- Vinyl material for indoor applications and TEDLAR[▲] material for outdoor and high temperature applications
- Labels are on 1.0" (25.4 mm) cores for PTR2 Printer

Choose the material that best suits your application:

| Material Code | Material Type | Temperature Range | Key Features | Color | Outdoor Rated | Hazardous Environment | UL Rec. | CSA |
|---------------|-------------------------------------|-----------------------------------|---|---------------------------------------|---------------|-----------------------|---------|-----|
| GMV3 | Self-Laminating Vinyl Film | -40°F to 176°F (-40°C to 80°C) | General purpose vinyl self-laminating labels | Clear w/ White Print-On Area | No | No | Yes | Yes |
| GMT1 | Self-Laminating TEDLAR [▲] | 0°F to 275°F (-18°C to 135°C) | Self-extinguishing, outdoor rated material; ideal for wire and cable labeling in harsh environments | Clear w/ White Print-On Area | Yes | Yes | Yes | Yes |

| Part Number | Total Area Width x Length In. (mm) | Print-On Area Width x Length In. (mm) | Labels Per Row | Nominal Cable O.D. * In. (mm) | Color | Material | Std. Pkg. Qty.* |
|-------------|------------------------------------|---------------------------------------|----------------|-------------------------------|-----------------------------|---------------------|-----------------|
| TTSL-247 | 0.80 x 0.94 (20.3 x 23.9) | 0.80 x 0.38 (20.3 x 9.7) | 5 | 0.12 - 0.18 (3.0 - 4.5) | White | Vinyl | 5000 |
| TTSL-246 | 0.80 x 0.94 (20.3 x 23.9) | 0.80 x 0.38 (20.3 x 9.7) | 5 | | White | TEDLAR [▲] | 5000 |
| TTSL-249 | 1.00 x 0.75 (25.4 x 19.1) | 1.00 x 0.38 (25.4 x 9.7) | 4 | 0.13 - 0.13 (3.0 - 3.0) | White | Vinyl | 2500 |
| TTSL-249YL† | 1.00 x 0.75 (25.4 x 19.1) | 1.00 x 0.38 (25.4 x 9.7) | 4 | | Yellow† | Vinyl | 2500 |
| TTSL-248 | 1.00 x 0.75 (25.4 x 19.1) | 1.00 x 0.38 (25.4 x 9.7) | 4 | 0.12 - 0.19 (3.0 - 4.5) | White | TEDLAR | 2500 |
| TTSL-251 | 1.00 x 0.94 (25.4 x 23.9) | 1.00 x 0.38 (25.4 x 9.7) | 4 | | White | Vinyl | 2500 |
| TTSL-251YL† | 1.00 x 0.94 (25.4 x 23.9) | 1.00 x 0.38 (25.4 x 9.7) | 4 | | Yellow† | Vinyl | 2500 |
| TTSL-250 | 1.00 x 0.94 (25.4 x 23.9) | 1.00 x 0.38 (25.4 x 9.7) | 4 | | White | TEDLAR | 2500 |
| TTSL-1 | 0.50 x 1.50 (12.7 x 38.1) | 0.50 x 0.50 (12.7 x 12.7) | 8 | 0.16 - 0.32 (4.0 - 8.1) | White | Vinyl | 5000 |
| TTSL-1YL† | 0.50 x 1.50 (12.7 x 38.1) | 0.50 x 0.50 (12.7 x 12.7) | 8 | | Yellow† | Vinyl | 5000 |
| TTSL-53 | 0.50 x 1.50 (12.7 x 38.1) | 0.50 x 0.50 (12.7 x 12.7) | 8 | | White | TEDLAR | 5000 |
| TTSL-2 | 1.00 x 1.50 (25.4 x 38.1) | 1.00 x 0.50 (25.4 x 12.7) | 4 | | White | Vinyl | 2500 |
| TTSL-2YL† | 1.00 x 1.50 (25.4 x 38.1) | 1.00 x 0.50 (25.4 x 12.7) | 4 | | Yellow† | Vinyl | 2500 |
| TTSL-54 | 1.00 x 1.50 (25.4 x 38.1) | 1.00 x 0.50 (25.4 x 12.7) | 4 | | White | TEDLAR | 2500 |
| TTSL-3 | 2.00 x 1.50 (50.8 x 38.1) | 2.00 x 0.50 (50.8 x 12.7) | 2 | | White | Vinyl | 1000 |
| TTSL-3YL† | 2.00 x 1.50 (50.8 x 38.1) | 2.00 x 0.50 (50.8 x 12.7) | 2 | | Yellow† | Vinyl | 1000 |
| TTSL-55 | 2.00 x 1.50 (50.8 x 38.1) | 2.00 x 0.50 (50.8 x 12.7) | 2 | | White | TEDLAR | 1000 |
| TTSL-4 | 1.00 x 2.44 (25.4 x 62.0) | 1.00 x 1.00 (25.4 x 25.4) | 4 | | 0.32 - 0.46 (8.1 - 11.6) | White | Vinyl |
| TTSL-4YL† | 1.00 x 2.44 (25.4 x 62.0) | 1.00 x 1.00 (25.4 x 25.4) | 4 | Yellow† | | Vinyl | 1500 |
| TTSL-56 | 1.00 x 2.44 (25.4 x 62.0) | 1.00 x 1.00 (25.4 x 25.4) | 4 | White | | TEDLAR | 1500 |
| TTSL-5 | 2.00 x 2.44 (50.8 x 62.0) | 2.00 x 1.00 (50.8 x 25.4) | 2 | White | | Vinyl | 500 |
| TTSL-5YL† | 2.00 x 2.44 (50.8 x 62.0) | 2.00 x 1.00 (50.8 x 25.4) | 2 | 0.32 - 0.93 (8.1 - 23.7) | Yellow† | Vinyl | 500 |
| TTSL-57 | 2.00 x 2.44 (50.8 x 62.0) | 2.00 x 1.00 (50.8 x 25.4) | 2 | | White | TEDLAR | 500 |
| TTSL-6 | 1.00 x 3.94 (25.4 x 100.1) | 1.00 x 1.00 (25.4 x 25.4) | 4 | 0.32 - 0.93 (8.1 - 23.7) | White | Vinyl | 1000 |
| TTSL-6YL† | 1.00 x 3.94 (25.4 x 100.1) | 1.00 x 1.00 (25.4 x 25.4) | 4 | | Yellow† | Vinyl | 1000 |
| TTSL-58 | 1.00 x 3.94 (25.4 x 100.1) | 1.00 x 1.00 (25.4 x 25.4) | 4 | | White | TEDLAR | 1000 |
| TTSL-7 | 2.00 x 3.94 (50.8 x 100.1) | 2.00 x 1.00 (50.8 x 25.4) | 2 | | White | Vinyl | 500 |
| TTSL-59 | 2.00 x 3.94 (50.8 x 100.1) | 2.00 x 1.00 (50.8 x 25.4) | 2 | White | TEDLAR | 500 | |

*Order number of labels required in multiples of Std. Pkg. Qty.

†For other TIA colors, substitute the following suffixes: RD=Red, VL=Violet, BR=Brown, GR=Green, IG=Gray, OR=Orange, BU=Blue

▲TEDLAR is a registered trademark of E.I. DuPont Co.

*Refer to Wire Size Selection Guide on page 196 to review diameters of commonly used cables

PTR2 Blank Labels



- Labels are on 3.0" (76.2 mm) cores and must be rear fed from PTR2 External Stand (see [page 20](#))

Choose the material that best suits your application:

| Material Code | Material Type | Temperature Range | Key Features | Color | Outdoor Rated | Hazardous Environment | UL Rec. | CSA |
|---------------|---------------------------|---------------------------------|---|--------|---------------|-----------------------|---------|-----|
| GMP4-W | Destructible Paper | -65°F to 160°F (-54°C to 71°C) | Tamper resistant litho paper for permanent applications | White | No | No | No | No |
| GMPE4-W | Destructible Polyethylene | -40°F to 176°F (-40°C to 80°C) | Destructible adhesive for permanent applications | White | No | No | No | No |
| GMY4-C | Clear Polyester | -40°F to 302°F (-40°C to 150°C) | Durable; high temperature; does not stretch or easily tear | Clear | Yes | Yes | No | No |
| GMY4-W | White Polyester | -40°F to 302°F (-40°C to 150°C) | Durable; high temperature; does not stretch or easily tear | White | Yes | Yes | No | No |
| GMY4-S | Metallized Polyester | -40°F to 302°F (-40°C to 150°C) | Durable; high temperature; does not stretch or easily tear; protects data EPROM by blocking out light | Silver | Yes | Yes | No | No |
| GMY4-STE | Tamper Evident Polyester | -40°F to 104°F (-40°C to 40°C) | Destructible material; label cannot be completely removed once applied | Silver | Yes | No | No | No |
| GMT4-W | TEDLAR * | -40°F to 275°F (-40°C to 135°C) | Indoor/outdoor high temperature labels; Self-extinguishing | White | Yes | Yes | No | No |

| Part Number | Material | Color | Label Width In. (mm) | Label Length In. (mm) | Horizontal Repeat In. (mm) | Vertical Repeat In. (mm) | Labels Per Row | Web Width In. (mm) | Std. Pkg. Qty.* |
|--------------|---------------------------|--------|----------------------|-----------------------|----------------------------|--------------------------|----------------|--------------------|-----------------|
| TTC3YS-10 | Polyester | Silver | 0.50 (12.7) | 0.44 (11.1) | 0.66 (16.8) | 0.48 (12.1) | 5 | 3.35 (85.1) | 10,000 |
| TTC3Y-10 | Polyester | White | 0.50 (12.7) | 0.44 (11.1) | 0.66 (16.8) | 0.48 (12.1) | 5 | 3.35 (85.1) | 10,000 |
| TTC3YST-10 | Tamper Evident Polyester | Silver | 0.50 (12.7) | 0.44 (11.1) | 0.66 (16.8) | 0.48 (12.1) | 5 | 3.35 (85.1) | 10,000 |
| TTC45Y-1 | Polyester | White | 0.50 (12.7) | 0.75 (19.1) | 0.50 (12.7) | 0.88 (22.2) | 8 | 4.25 (108.0) | 1000 |
| TTC-DS110-1 | Polyester | White | 0.50 (12.7) | 7.88 (200.0) | — | 8.13 (206.4) | 1 | 1.25 (31.8) | 1000 |
| TTC6Y-10 | Polyester | White | 0.90 (22.9) | 0.25 (6.4) | 1.13 (28.6) | 0.35 (8.9) | 3 | 3.35 (85.1) | 10,000 |
| TTC6T-10 | TEDLAR * | White | 0.90 (22.9) | 0.25 (6.4) | 1.13 (28.6) | 0.35 (8.9) | 3 | 3.35 (85.1) | 10,000 |
| TTC7YS-10 | Polyester | Silver | 1.00 (25.4) | 0.38 (9.5) | 1.08 (27.3) | 0.48 (12.1) | 3 | 3.35 (85.1) | 10,000 |
| TTC7Y-10 | Polyester | White | 1.00 (25.4) | 0.38 (9.5) | 1.08 (27.3) | 0.48 (12.1) | 3 | 3.35 (85.1) | 10,000 |
| TTC8ET-10 | Destructible Polyethylene | White | 1.00 (25.4) | 0.50 (12.7) | 1.08 (27.3) | 0.60 (15.2) | 3 | 3.35 (85.1) | 10,000 |
| TTC8YS-10 | Polyester | Silver | 1.00 (25.4) | 0.50 (12.7) | 1.08 (27.3) | 0.60 (15.2) | 3 | 3.35 (85.1) | 10,000 |
| TTC8YC-10 | Polyester | Clear | 1.00 (25.4) | 0.50 (12.7) | 1.08 (27.3) | 0.63 (15.9) | 3 | 3.35 (85.1) | 10,000 |
| TTC8Y-10 | Polyester | White | 1.00 (25.4) | 0.50 (12.7) | 1.08 (27.3) | 0.60 (15.2) | 3 | 3.35 (85.1) | 10,000 |
| TTC8YST-10 | Tamper Evident Polyester | Silver | 1.00 (25.4) | 0.50 (12.7) | 1.08 (27.3) | 0.60 (15.2) | 3 | 3.35 (85.1) | 10,000 |
| TTC8T-10 | TEDLAR | White | 1.00 (25.4) | 0.50 (12.7) | 1.08 (27.3) | 0.60 (15.2) | 3 | 3.35 (85.1) | 10,000 |
| TTC-MJ-5 | Polyester | Clear | 1.38 (34.9) | 0.19 (4.8) | — | 0.38 (9.5) | 1 | 2.25 (57.2) | 5000 |
| TTC-MJWH-5 | Polyester | White | 1.38 (34.9) | 0.19 (4.8) | — | 0.38 (9.5) | 1 | 2.25 (57.2) | 5000 |
| TTC15P-2.5 | Paper | White | 1.50 (38.1) | 1.00 (25.4) | — | 1.63 (41.3) | 1 | 1.75 (44.5) | 2500 |
| TTC15Y-2.5 | Polyester | White | 1.50 (38.1) | 1.00 (25.4) | — | 1.63 (41.3) | 1 | 1.75 (44.5) | 2500 |
| TTC17Y-2.5 | Polyester | White | 1.63 (41.3) | 1.25 (31.8) | — | 1.38 (34.9) | 1 | 2.20 (55.9) | 2500 |
| TTC-EFPLC-1 | Polyester | Clear | 1.80 (45.7) | 0.38 (9.5) | — | 0.63 (15.9) | 1 | 2.25 (57.2) | 1000 |
| TTC-EFPL-1 | Polyester | White | 1.80 (45.7) | 0.38 (9.5) | — | 0.63 (15.9) | 1 | 2.25 (57.2) | 1000 |
| TTC18Y-2.5 | Polyester | White | 2.00 (50.8) | 0.25 (6.4) | — | 0.38 (9.5) | 1 | 2.20 (55.9) | 2500 |
| TTC19Y-2.5 | Polyester | White | 2.00 (50.8) | 0.50 (12.7) | — | 0.60 (15.2) | 1 | 2.20 (55.9) | 2500 |
| TTC20YS-2.5 | Polyester | Silver | 2.00 (50.8) | 1.00 (25.4) | — | 1.13 (28.6) | 1 | 2.20 (55.9) | 2500 |
| TTC20P-2.5 | Paper | White | 2.00 (50.8) | 1.00 (25.4) | — | 1.13 (28.6) | 1 | 2.20 (55.9) | 2500 |
| TTC20YC-2.5 | Polyester | Clear | 2.00 (50.8) | 1.00 (25.4) | — | 1.13 (28.6) | 1 | 2.20 (55.9) | 2500 |
| TTC20Y-2.5 | Polyester | White | 2.00 (50.8) | 1.00 (25.4) | — | 1.13 (28.6) | 1 | 2.20 (55.9) | 2500 |
| TTC20YST-2.5 | Tamper Evident Polyester | Silver | 2.00 (50.8) | 1.00 (25.4) | — | 1.13 (28.6) | 1 | 2.20 (55.9) | 2500 |
| TTC21P-2.5 | Paper | White | 2.00 (50.8) | 1.25 (31.8) | — | 1.38 (34.9) | 1 | 2.20 (55.9) | 2500 |
| TTC22YS-2.5 | Polyester | Silver | 2.75 (69.9) | 1.25 (31.8) | — | 1.38 (34.9) | 1 | 2.95 (74.9) | 2500 |
| TTC22P-2.5 | Paper | White | 2.75 (69.9) | 1.25 (31.8) | — | 1.38 (34.9) | 1 | 2.95 (74.9) | 2500 |
| TTC22Y-2.5 | Polyester | White | 2.75 (69.9) | 1.25 (31.8) | — | 1.38 (34.9) | 1 | 2.95 (74.9) | 2500 |

Labels are roll mounted on 3.00" (76.2 mm) core.
 *Order number of labels required in multiples of Std. Pkg. Qty.
 *TEDLAR is the registered trademark of E. I. DuPont Co.

PTR2 Blank Labels (cont.)

| Part Number | Material | Color | Label Width In. (mm) | Label Length In. (mm) | Horizontal Repeat In. (mm) | Vertical Repeat In. (mm) | Labels Per Row | Web Width In. (mm) | Std. Pkg. Qty.* |
|--------------|--------------------------|--------|----------------------|-----------------------|----------------------------|--------------------------|----------------|--------------------|-----------------|
| TTC-EFPL10-1 | Polyester | White | 2.90 (73.7) | 0.30 (7.6) | — | 0.55 (14.0) | 1 | 3.25 (82.6) | 1000 |
| TTC23Y-2.5 | Polyester | White | 3.00 (76.2) | 0.25 (6.4) | — | 0.38 (9.5) | 1 | 3.20 (81.3) | 2500 |
| TTC46P-5 | Paper | White | 3.00 (76.2) | 0.94 (23.8) | — | 1.06 (27.0) | 1 | 3.35 (85.1) | 5000 |
| TTC24YS-2.5 | Polyester | Silver | 3.00 (76.2) | 1.00 (25.4) | — | 1.13 (28.6) | 1 | 3.20 (81.3) | 2500 |
| TTC24P-2.5 | Paper | White | 3.00 (76.2) | 1.00 (25.4) | — | 1.13 (28.6) | 1 | 3.20 (81.3) | 2500 |
| TTC24YC-2.5 | Polyester | Clear | 3.00 (76.2) | 1.00 (25.4) | — | 1.13 (28.6) | 1 | 3.20 (81.3) | 2500 |
| TTC24Y-2.5 | Polyester | White | 3.00 (76.2) | 1.00 (25.4) | — | 1.13 (28.6) | 1 | 3.20 (81.3) | 2500 |
| TTC24YST-2.5 | Tamper Evident Polyester | Silver | 3.00 (76.2) | 1.00 (25.4) | — | 1.13 (28.6) | 1 | 3.20 (81.3) | 2500 |
| TTC25YS-1 | Polyester | Silver | 3.00 (76.2) | 2.00 (50.8) | — | 2.13 (54.0) | 1 | 3.20 (81.3) | 1000 |
| TTC25P-1 | Paper | White | 3.00 (76.2) | 2.00 (50.8) | — | 2.13 (54.0) | 1 | 3.20 (81.3) | 1000 |
| TTC25YC-1 | Polyester | Clear | 3.00 (76.2) | 2.00 (50.8) | — | 2.13 (54.0) | 1 | 3.20 (81.3) | 1000 |
| TTC25Y-1 | Polyester | White | 3.00 (76.2) | 2.00 (50.8) | — | 2.13 (54.0) | 1 | 3.20 (81.3) | 1000 |
| TTC25YST-1 | Tamper Evident Polyester | Silver | 3.00 (76.2) | 2.00 (50.8) | — | 2.13 (54.0) | 1 | 3.20 (81.3) | 1000 |
| TTC26P-1 | Paper | White | 3.00 (76.2) | 5.00 (127.0) | — | 5.13 (130.2) | 1 | 3.20 (81.3) | 1000 |
| TTC27Y-10 | Polyester | White | 3.25 (82.6) | 0.31 (7.9) | — | 0.44 (11.1) | 1 | 4.20 (106.7) | 10,000 |
| TTC28Y-10 | Polyester | White | 3.25 (82.6) | 0.50 (12.7) | — | 0.63 (15.9) | 1 | 4.20 (106.7) | 10,000 |
| TTC29Y-5 | Polyester | White | 3.25 (82.6) | 0.63 (15.9) | — | 0.75 (19.1) | 1 | 4.20 (106.7) | 5000 |
| TTC30Y-2.5 | Polyester | White | 3.25 (82.6) | 0.81 (20.6) | — | 0.94 (23.8) | 1 | 4.20 (106.7) | 2500 |
| TTC31P-1 | Paper | White | 3.50 (88.9) | 1.00 (25.4) | — | 1.13 (28.6) | 1 | 3.75 (95.3) | 1000 |
| TTC31Y-1 | Polyester | White | 3.50 (88.9) | 1.00 (25.4) | — | 1.13 (28.6) | 1 | 3.75 (95.3) | 1000 |
| TTC32P-1 | Paper | White | 3.50 (88.9) | 8.00 (203.2) | — | 8.13 (206.4) | 1 | 3.75 (95.3) | 1000 |
| TTC32Y-1 | Polyester | White | 3.50 (88.9) | 8.00 (203.2) | — | 8.13 (206.4) | 1 | 3.75 (95.3) | 1000 |
| TTC34P-.5 | Paper | White | 3.63 (92.1) | 4.20 (107.1) | — | 4.34 (110.3) | 1 | 4.20 (106.7) | 500 |
| TTC33P-.5 | Paper | White | 3.63 (92.1) | 5.79 (147.1) | — | 5.92 (150.3) | 1 | 4.20 (106.7) | 500 |
| TTC35P-2.5 | Paper | White | 4.00 (101.6) | 1.00 (25.4) | — | 4.13 (104.8) | 1 | 4.20 (106.7) | 2500 |
| TTC35Y-2.5 | Polyester | White | 4.00 (101.6) | 1.00 (25.4) | — | 4.13 (104.8) | 1 | 4.20 (106.7) | 2500 |
| TTC36YS-1 | Polyester | Silver | 4.00 (101.6) | 2.00 (50.8) | — | 2.13 (54.0) | 1 | 4.20 (106.7) | 1000 |
| TTC36P-1 | Paper | White | 4.00 (101.6) | 2.00 (50.8) | — | 2.13 (54.0) | 1 | 4.20 (106.7) | 1000 |
| TTC36Y-1 | Polyester | White | 4.00 (101.6) | 2.00 (50.8) | — | 2.13 (54.0) | 1 | 4.20 (106.7) | 1000 |
| TTC37P-1 | Paper | White | 4.00 (101.6) | 3.00 (76.2) | — | 3.13 (79.4) | 1 | 4.20 (106.7) | 1000 |
| TTC37Y-1 | Polyester | White | 4.00 (101.6) | 3.00 (76.2) | — | 3.13 (79.4) | 1 | 4.20 (106.7) | 1000 |
| TTC38P-1 | Paper | White | 4.00 (101.6) | 4.00 (101.6) | — | 4.13 (104.8) | 1 | 4.20 (106.7) | 1000 |
| TTC38Y-1 | Polyester | White | 4.00 (101.6) | 4.00 (101.6) | — | 4.13 (104.8) | 1 | 4.20 (106.7) | 1000 |
| TTC39P-1 | Paper | White | 4.00 (101.6) | 5.00 (127.0) | — | 5.13 (130.2) | 1 | 4.20 (106.7) | 1000 |
| TTC39Y-1 | Polyester | White | 4.00 (101.6) | 5.00 (127.0) | — | 5.13 (130.2) | 1 | 4.20 (106.7) | 1000 |
| TTC40P-1 | Paper | White | 4.00 (101.6) | 6.00 (152.4) | — | 6.06 (154.0) | 1 | 4.20 (106.7) | 1000 |
| TTC41P-1 | Paper | White | 4.00 (101.6) | 6.50 (165.1) | — | 6.63 (168.3) | 1 | 4.20 (106.7) | 1000 |
| TTC41Y-1 | Polyester | White | 4.00 (101.6) | 6.50 (165.1) | — | 6.63 (168.3) | 1 | 4.20 (106.7) | 1000 |
| TTC42P-1 | Paper | White | 4.00 (101.6) | 12.88 (327.0) | — | 13.00 (330.2) | 1 | 4.20 (106.7) | 500 |
| TTC42Y-1 | Polyester | White | 4.00 (101.6) | 12.88 (327.0) | — | 13.00 (330.2) | 1 | 4.20 (106.7) | 500 |

Labels are roll mounted on 3.00" (76.2 mm) core.
 *Order number of labels required in multiples of Std. Pkg. Qty.

PTR2 Heat Shrink Wire and Cable Markers and Accessories



Heat Shrink Wire and Cable Markers

- Produce durable, high quality permanent heat shrink markers
- Pre-cut tubing mounted on plastic carrier
- Service Temperature Range: -22°F to 220°F (-30°C to 105°C)
- Shrink Ratio 3:1 @ 212°F (100°C)
- Flammability: Meets U.L. Standard 224 for flammability
- For best results, print with TTRW-BL Wax Ribbon

| Part Number | Diameter In. (mm) | Marker Width In. (mm) | Markers Per Row | Nominal Cable O.D. In. (mm) | Material | Color | Mkrs Per Roll | Std. Pkg. Qty.* |
|-------------|-------------------|-----------------------|-----------------|-----------------------------|--------------------------|--------|---------------|-----------------|
| LHS12W1 | 0.13 (3.2) | 2.00 (50.8) | 1 | 0.04 - 0.13 (1.1 - 3.2) | 3:1 Flattened Polyolefin | White | 500 | 1 |
| LHS12W2 | 0.13 (3.2) | 1.00 (25.4) | 2 | | | | 1000 | 1 |
| LHS12W4 | 0.13 (3.2) | 0.50 (12.7) | 4 | | | | 2000 | 1 |
| LHS18W1 | 0.18 (4.8) | 2.00 (50.8) | 1 | 0.06 - 0.18 (1.6 - 4.8) | | | 500 | 1 |
| LHS18W2 | 0.18 (4.8) | 1.00 (25.4) | 2 | | | | 1000 | 1 |
| LHS18W4 | 0.18 (4.8) | 0.50 (12.7) | 4 | | | | 2000 | 1 |
| LHS25W1 | 0.25 (6.4) | 2.00 (50.8) | 1 | 0.08 - 0.25 (2.1 - 6.4) | | | 500 | 1 |
| LHS25W2 | 0.25 (6.4) | 1.00 (25.4) | 2 | | | | 1000 | 1 |
| LHS25W4 | 0.25 (6.4) | 0.50 (12.7) | 4 | | | | 2000 | 1 |
| LHS50W1 | 0.50 (12.7) | 2.00 (50.8) | 1 | 0.17 - 0.50 (4.2 - 12.7) | | | 500 | 1 |
| LHS50W2 | 0.50 (12.7) | 1.00 (25.4) | 2 | | | | 1000 | 1 |
| LHS100W1 | 1.00 (25.4) | 2.00 (50.8) | 1 | 0.33 - 1.00 (8.4 - 25.4) | | | 250 | 1 |
| LHS100W2 | 1.00 (25.4) | 1.00 (25.4) | 2 | | 500 | 1 | | |
| LHS12Y1 | 0.13 (3.2) | 2.00 (50.8) | 1 | 0.04 - 0.13 (1.1 - 3.2) | 3:1 Flattened Polyolefin | Yellow | 500 | 1 |
| LHS12Y2 | 0.13 (3.2) | 1.00 (25.4) | 2 | | | | 1000 | 1 |
| LHS12Y4 | 0.13 (3.2) | 0.50 (12.7) | 4 | | | | 2000 | 1 |
| LHS18Y1 | 0.18 (4.8) | 2.00 (50.8) | 1 | 0.06 - 0.18 (1.6 - 4.8) | | | 500 | 1 |
| LHS18Y2 | 0.18 (4.8) | 1.00 (25.4) | 2 | | | | 1000 | 1 |
| LHS18Y4 | 0.18 (4.8) | 0.50 (12.7) | 4 | | | | 2000 | 1 |
| LHS25Y1 | 0.25 (6.4) | 2.00 (50.8) | 1 | 0.08 - 0.25 (2.1 - 6.4) | | | 500 | 1 |
| LHS25Y2 | 0.25 (6.4) | 1.00 (25.4) | 2 | | | | 1000 | 1 |
| LHS25Y4 | 0.25 (6.4) | 0.50 (12.7) | 4 | | | | 2000 | 1 |
| LHS50Y1 | 0.50 (12.7) | 2.00 (50.8) | 1 | 0.17 - 0.50 (4.2 - 12.7) | | | 500 | 1 |
| LHS50Y2 | 0.50 (12.7) | 1.00 (25.4) | 2 | | | | 1000 | 1 |
| LHS100Y1 | 1.00 (25.4) | 2.00 (50.8) | 1 | 0.33 - 1.00 (8.4 - 25.4) | | | 250 | 1 |
| LHS100Y2 | 1.00 (25.4) | 1.00 (25.4) | 2 | | 500 | 1 | | |

*Order number of rolls required in multiples of Std. Pkg. Qty.

*Refer to Wire Size Selection Guide on page 196 to review diameters of commonly used cables

PAN-SHRINK Heat Shrink Tools and Accessories

- For use with all Panduit Heat Shrink Markers
- Other Heat Shrink Tools and replacement parts available. Contact factory for details.



| Part Number | Description | Std. Pkg. Qty.* |
|--------------|--|-----------------|
| HSG-115V-500 | General Purpose Tool – Air intake regulator varies temperature from 500°F (260°C) to 620°F (344°C), 115 Vdlt, 11 AMP. Neoprene jacketed cord with molded strain relief | 1 |
| HSG-115V-300 | Low Temperature Tool – For use on small sizes of heat shrink when under or near heat sensitive items. Air intake regulator varies temperature from 300°F (145°C) to 450°F (232°C), 115 Volt, 8 AMP. Neoprene jacketed cord with molded strain relief | 1 |
| HSG-A1 | Shrink tube reflector for tubing up to 0.75" (19.1 mm) inside diameter – Directs heat around the tubing to reduce shrink time. | 1 |
| HSG-A2 | Shrink tube reflector for tubing up to 1.50" (38.1 mm) inside diameter – Directs heat around the tubing to reduce shrink time. | 1 |
| HSG-A3 | Shrink tube concentrator – Directs heat toward tubing and away from heat sensitive items. | 1 |
| HSG-A4 | Black polyethylene case – Stores heat tool, stand and all three accessories. | 1 |

*Order number of heat shrink accessories required in multiples of Std. Pkg. Qty.



PTR3 Thermal Transfer Printer



Fast, rugged printer for high volume applications

- High speed 32-bit RISC processor provides maximum performance at speeds up to 10 inches per second
- Prints on all Panduit Thermal Transfer Labels including self-laminating labels, component labels and heat shrink (see [pages 33-45](#))
- Prints crisp, superior quality 203 dpi resolution images
- Compatible with Panduit® **PAN-MARK™ 2.5 or higher for WINDOWS^** Label Printing Software (See [page 28](#) for complete software information)

Mechanical Information

Print Method: Thermal transfer and direct thermal printing

Size:
 Height: 13.5" (341 mm)
 Width: 10.4" (265 mm)
 Depth: 17.0" (430 mm)
 Weight: 40 lbs. (18 kg)

Print Speed: Up to 10 inches per second (254 mm per second)

Print Width: 4.1" (104 mm)

Media:
 Roll Width: 1.0" - 5.0" (25 mm - 125 mm)
 Min. Core Diameter: 1.5" (38 mm)
 Max. Roll Diameter: 8.6" (220 mm)

Sensors: Adjustable position transmissive sensor for die cut labels and tags.
 Reflective sensor for use with preprinted sensing marks.
 Automatic, programmable setting of top of form.

Resolution: 203 dpi (8 dots/mm)

Print Information

- Inherent Bar Codes:

| | | |
|-------------|--------------------|-------------|
| Bookland | EAN 8 | MSI Plessey |
| Code 39 | EAN 13 | PDF417 |
| Code 93 | Industrial 2 of 5 | Postnet |
| Code 128 | Interleaved 2 of 5 | UPC-A |
| CODABAR | Matrix 2 of 5 | UPC-E |
| Data Matrix | Maxicode | |

- Text and bar codes can be printed in four directions: 0°, 90°, 180°, 270°
- Character expansion horizontally and vertically in 12 steps
- Dot-addressable graphics
- Sequential numbering
- Form overlay for high speed editing of complex formats

Printer and Accessories

| Part Number | Description | Std. Pkg. Qty.* |
|-------------|--|-----------------|
| PTR3 | Thermal Transfer Printer | 1 |
| PTR-CLN | Printer Cleaning Kit Contains 4 oz. (116 ml) bottle cleaning solution with MSDS, cleaning pen, 100 swabs, 12 alcohol wipes and instructions | 1 |

*Order number of printers required in multiples of Std. Pkg. Qty.

Ribbons

| Part Number | Width In. (mm) | Length Ft. (m) | Type | Color | Std. Pkg. Qty.* |
|-------------|----------------|----------------|-------|-------|-----------------|
| TTR4-BL-S | 4.30 (109.2) | 1181 (360.0) | Resin | Black | 1 |
| TTR4W-BL-S | | | Wax | Black | |

*Order number of ribbons required in multiples of Std. Pkg. Qty.

See [pages 33-45](#) for complete label information.

Panduit Software



PAN-MARK for WINDOWS 2.5[^]

Page 28

Part Number: PROG-WIN2

- Designed to be used in WINDOWS
- Extensive bar code, serialization and importing features
- Supports all WINDOWS printer drivers and can be used to drive Panduit LS5E Thermal Transfer Labeling Systems, PTR1 Dot-Matrix Printer, **DURA-MARK™** PTR2 Thermal Transfer Printer and the PTR3 Thermal Transfer Printer (see **pages 12 - 26**)
- Easy to install
- Suggested minimum 486 processor with 8 Mb of RAM



PAN-MARK LT Labeling Software

Page 29

Part Number: PDL-PROG-LT

- Quickest of all DOS packages
- Requires 2 Mb of RAM
- Creates labels quickly and prints quickly
- Used with both dot-matrix and laser printers
- Features serialization, alpha and numeric
- Suggested minimum 286 processor with 2 Mb of RAM



PROG-LITE for DOS Labeling Software

Page 30

Part Number: PROG-LITE

- Used to drive Panduit PTR1 Dot-Matrix Printer to create **ON-DEMAND™** Wire Marker Cards in a DOS environment
- Suggested minimum 286 processor with 2 Mb of RAM



SAFETY EASE™ Marker and Tag Software

Page 31-32

Part Number: SEZ-PM

- Create Custom Electrical Markers, Tags and Pipe Markers
- Can be used with the **DURA-MARK™** PTR2 Thermal Transfer Printer or your own ink jet or laser printer
- Includes pictographs, serialization and the ability to add additional information
- System Requirements: WINDOWS 3.1 or higher, 386 processor or higher, 4 MB RAM for Windows 3.1 and 3.11, 8 MB RAM for Windows 95, 5 MB hard drive space

[^]WINDOWS is a registered trademark of Microsoft Corp.



Easy serialization, bar code, and graphic import options make complex labels seem simple

PAN-MARK™ for WINDOWS^ 2.5

- 21 Resident Bar Code Symbologies
- Ability to create spreadsheets and databases within the program for data import and information storage
- Import data from most Microsoft databases such as EXCEL^ and ACCESS^
- Easy to enter different text on each label — simply type the text and press Page Down for the next label!
- Easy to install and available on CD-ROM
- Includes all of the latest label formats for Panduit Thermal Transfer, Ink Jet, Laser and Dot-Matrix Labels

Software Features

- Uses all WINDOWS printer drivers and can be used to drive Panduit LS5E, PTR1, PTR2 and PTR3 Printers (see pages 12-26)
- ODBC (Open Data-Base Connectivity) allows importing of information from electronic databases such as EXCEL^ and ACCESS^ directly onto the label formats
- Tool menu allows user to add to favorite WINDOWS tools
- Uses a full range of WINDOWS fonts including TrueType* fonts
- Print from 2 pt. to 300 pt. + on the same label
- Panduit label formats ready to use
- Create custom label formats
- Wire Marker designs
- Image and text scaling
- Date, time, series, graphic and data import fields
- Format and label previews
- Print preview
- Multiple print range selection
- Text rotation and alignment

Edit Functions

- Standard copy, cut and paste
- Copy multiple labels
- Remove, Insert and Find a label

Serialization

- Alpha, numeric, octal, hexadecimal and combinations
- Multiple serialized strings in same file
- Easy text and serialization combination
- Insert constants in an existing file



Create multiple legends for wire marking



Bar code pull down menu provides fast and easy editing

Bar Code Features

- Easily create certified bar codes
- Resident Bar Code Symbologies
 - Codabar
 - Code 128 (A, Auto, B, C)
 - Code 39 (Std, Ext)
 - Code 93 (Std, Ext)
 - EAN/JAN 13
 - EAN/JAN 8
 - HIBC/HIBC-LIC
 - Interleaved 2 of 5
 - MSI Plessey
 - PDF 417
 - UCC 128
 - UPC (A, E: 11 Digit, System 0, System 1)
 - Zip+4 Postal Codes

Image Functions

- Import Bitmap (.BMP) graphic images into a label — add you own company logo to labels!
- Copy image from one label to others
- Image library includes common electrical and datacomm symbols

System Requirements

- Designed for 3.1, 3.11, WINDOWS 95, 98 and NT
- Mouse or keyboard driven
- Recommend 486 processor, min. 8 Mb of RAM
- 30 Mb of hard drive space

| Part Number | Format | Std. Pkg. Qty.* |
|-------------|------------|-----------------|
| PROG-WIN2 | 3.5" Disks | 1 |
| PROG-WIN2CD | CD-ROM | 1 |

*Order number of programs required in multiples of Std. Pkg. Qty.

^WINDOWS is a registered trademark of Microsoft Corp.

*TrueType is a registered trademark of Apple Computing, Inc.

PAN-MARK™ LT Labeling Software

Part Number

PDL-PROG-LT



- Available in 3.5" and 5.25" disk types.

- Fastest label generation of any DOS package
- Designed for anyone who desires a labeling system, but is concerned with cost
- Used with Panduit Computer Printable Labels to meet unique labeling applications



SOFTWARE FEATURES

- Easy to change printers
- Ability to add special ASCII characters to legend
- Context sensitive help screens throughout
- Supplied with 5.25" and 3.5" disks
- Ability to append label files
- Ability to change work directory
- Capacity to add custom label formats
- Supports mouse
- DOS Shell
- Prints without saving
- Pull-down menus and selection of menu colors
- Selection of video mode

EDIT FUNCTIONS

- Copy fields between labels in a file
- Copy fields between label files
- Selection of various character sizes
- Multiple copy of constant text
- Remove label
- Insert label
- Copy label

SERIALIZATION

- Alpha and Numeric
- In conjunction with standard text
- One or several serializations in the same file

SYSTEM REQUIREMENTS

- IBM PC or compatible
- 286 processor or higher
- 2 Mb of RAM (or higher)

SUPPORTED PRINTERS

- ALPS Model 24
- ALPS ASP1000
- Epson EX (Series)
- Epson FX (Series)
- Epson FX-286e
- Epson LQ-800 / 850 / 570 / 870 / 950 / 1000 / 1050 / 2500
- Epson LX
- Epson RX
- HP Laser (in text mode) 10, 12 and 16.7 cpi
- IBM Proprinter X24 / XL24
- Okidata 193 / 320 / 390
- Panasonic KX-P1092 / KX-P1124 / KX-P1524 / KX-P1592 / KX-P1595
- Practical Automation
- NEC Pinwriter 2200 / 5200 / 5300
- Seikosua SP2400

PAN-MARK LT will also work on an Epson or IBM Proprinter X24 / XL24 compatible

PROG-LITE for DOS Labeling Software

| |
|-------------|
| Part Number |
| PROG-LITE |

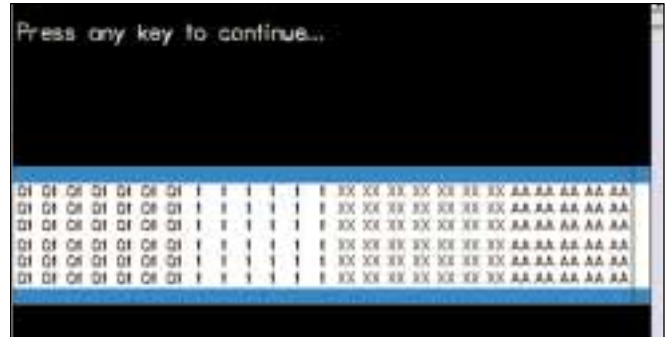

- Used to drive Panduit PTR1 Dot-Matrix Printer to create **ON-DEMAND™** Wire Marker Cards in a DOS environment
- See [page 17](#) for complete information on the Panduit PTR1 Printer
- Provided on 3.5" disks

SYSTEM REQUIREMENTS

- IBM PC or compatible
- 286 processor or higher
- 2 Mb of RAM (or higher)



SAFETY EASE™ Marker and Tag Software

Create Custom Markers and Tags — Just In Time!

- Produce English, Spanish and Bilingual electrical markers, tags and pipe markers with your own computer
- Can be used with the **DURA-MARK™** PTR2 Thermal Transfer Printer or your own ink jet or laser printer
- Requires no instruction manual
- Includes pictographs, serialization and the ability to add additional information
- Installs in less than 5 minutes!
- System Requirements: WINDOWS^ 3.1 or higher, 386 processor or higher, 4 MB RAM for Windows 3.1 and 3.11, 8 MB RAM for Windows 95, 5 MB hard drive space

| Part Number | Description | Std. Pkg. Qty.* |
|-------------|---|-----------------|
| SEZ-PM | SAFETY EASE Marker and Tag Software | 1 |

*Order number of programs required in multiples of Std. Pkg. Qty.



SAFETY EASE / DURA-MARK System:

Use your own computer and the PTR2 Printer with **SAFETY EASE** Software to produce vivid indoor/outdoor adhesive vinyl markers and signs

- Order supplies individually (see [pages 20-21](#)) or in kits shown below
- Sign blanks are shown below to convert adhesive markers to non-adhesive signs

SAFETY EASE Electrical Marker and Tag Kit

- To create tags and 2" high yellow and orange markers
- Part Number: SEZ-ELECKIT1

| Supplies Included | Description | Qty. |
|-------------------|---|------|
| PTR2 | DURA-MARK Printer | 1 |
| SEZ-PM | SAFETY EASE Software | 1 |
| TTV2-YEL | 2" x 100' Yellow Thermal Transfer Roll | 1 |
| TTV2-ORG | 2" x 100' Orange Thermal Transfer Roll | 1 |
| TTR2-BL | 2" Black Ribbon | 1 |
| PST-4 | 3.50" x 5.75" Self-laminating Tag with Nylon ties | 25 |

Order number of kits required

SAFETY EASE Pipe Marker and Tag Kit

- To create tags and 2" high yellow and green markers
- Part Number: SEZ-PIPEKIT1

| Supplies Included | Description | Qty. |
|-------------------|---|------|
| PTR2 | DURA-MARK Printer | 1 |
| SEZ-PM | SAFETY EASE Software | 1 |
| TTV2-YEL | 2" x 100' Yellow Thermal Transfer Roll | 1 |
| TTV2-GRN | 2" x 100' Orange Thermal Transfer Roll | 1 |
| TTR2-WH | 2" White Ribbon | 1 |
| TTR2-BL | 2" Black Ribbon | 1 |
| PST-4 | 3.50" x 5.75" Self-laminating Tag with Nylon ties | 25 |

Order number of kits required

Sign Blanks

- Print legend on clear tape (see [page 21](#)) and adhere marker to any of the sign blanks shown



| Header | Color (Legend/Background) | Size Height x Length In. (mm) | Polyester Film Self-Adhesive | Rigid Polyethylene Non-Adhesive |
|----------------------|---------------------------|--|---|---|
| CAUTION | Black/Yellow | 7 x 10 (178 x 254) 10 x 14 (254 x 356) 14 x 20 (256 x 508) | PPS0710C442 PPS1014C442 PPS1420C442 | PRS0710C442 PRS1014C442 PRS1420C442 |
| DANGER | Red and Black/White | 7 x 10 (178 x 254) 10 x 14 (254 x 356) 14 x 20 (256 x 508) | PPS0710D440 PPS1014D440 PPS1420D440 | PRS0710D440 PRS1014D440 PRS1420D440 |
| NOTICE | Black and Blue/White | 7 x 10 (178 x 254) 10 x 14 (254 x 356) 14 x 20 (256 x 508) | PPS0710N443 PPS1014N443 PPS1420N443 | PRS0710N443 PRS1014N443 PRS1420N443 |
| Blank Sign-No Header | White | 7 x 10 (178 x 254) 10 x 14 (254 x 356) 14 x 20 (256 x 508) | PPS0710BWHT PPS1014BWHT PPS1420BWHT | PRS0710BWHT PRS1014BWHT PRS1420BWHT |
| Blank Sign-No Header | Yellow | 7 x 10 (178 x 254) 10 x 14 (254 x 356) 14 x 20 (256 x 508) | PPS0710BYEL PPS1014BYEL PPS1420BYEL | PRS0710BYEL PRS1014BYEL PRS1420BYEL |

Order number of signs required

^WINDOWS is a registered trademark of Microsoft corp.

SAFETY EASE™ Products (cont.)



SAFETY EASE / Laser or Ink Jet Printer System:

Use your own computer and laser or ink jet printer with **SAFETY EASE** Software to create indoor electrical markers, tags and pipe markers

- Create paper markers and tags on your printer
- Self-Laminating Adhesive carriers convert paper to adhesive indoor markers
- Safety Tag Carriers convert paper to rigid indoor tags
- Card Stock Tag sheets available to create temporary tags

Self-Laminating Indoor Polyester Adhesive Carriers

- Convert paper to adhesive indoor markers
- For clean and dry surfaces
- Cut out paper marker and insert into the self-laminating adhesive carrier

| Part Numbers | For Maximum Marker Size W X L In. (mm) | Carriers/Pkg | Std. Pkg. Qty.* |
|--------------|--|--------------|-----------------|
| SEZ-PMC.75 | 9.00 x 1.50 (228.6 x 38.1) | 5 | 1 Pkg. |
| SEZ-PMC1 | 12.00 x 2.00 (304.8 x 50.8) | | |
| SEZ-PMC2 | 16.00 x 3.00 (406.4 x 76.2) | | |
| SEZ-PMC6 | 23.00 x 4.00 (584.2 x 101.6) | | |
| SEZ-PMC8 | 32.00 x 9.00 (812.8 x 228.6) | | |

* Order number of Std. Pkg's required.

Indoor Rigid Vinyl Safety Tag Carriers for Laser and Ink Jet Printers

- Create your own rigid indoor tags with protected legends in minutes! Using the PST Tag carrier allows tags to be resistant to mild chemicals and acids. Sturdy brass grommet provides extra durability
- Panduit PLT2S (7.4") nylon ties included for quick and easy installation

| Part Numbers | Description | Lamination | No. of Carriers and Ties/ Pkg. | Std. Pkg. Qty.* |
|--------------|---------------------------------|----------------------|--------------------------------|-----------------|
| PST-4 | Tag Carriers with overlaminated | Front Side Only | 25 | 1 Pkg. |
| PST-6 | | | 100 | |
| PST-5 | | Front and Back Sides | 25 | |
| PST-7 | | | 100 | |

* Order number of Std. Pkg's required.



Print paper tag using a laser or ink-jet printer. Use scissors to cut out tag.



Place tag between self-adhesive laminate liner and rigid vinyl backing. Fasten tag with Panduit Cable Tie.

Economical Card Stock Tags for Ink Jet Printers

- Economical solution for temporary, indoor tags



Print sheet of tag stock using an ink-jet printer. Tear tags apart on perforation.

| Part Numbers | Description | Color | Sheets/ Pkg. | Std. Pkg. Qty.* |
|--------------|--|--------|--------------|-----------------|
| SEZ-TAGWH | Perforated card stock, four blank tags per sheet | White | 25 | 1 Pkg. |
| SEZ-TAGOR | | Orange | | |
| SEZ-TAGY | | Yellow | | |
| SEZ-TAGRD | | Red | | |
| SEZ-TAGGR | | Green | | |
| SEZ-TAGBU | | Blue | | |

* Order number of Std. Pkg's required.



Panduit offers high quality thermal transfer labels in a variety of materials, sizes and styles.

Panduit Thermal Transfer Labels are used for a wide variety of identification purposes including wire marking, bar code labeling, and shipment tracking. Label materials are available that provide weather and chemical resistance and withstand temperature extremes and UV exposure. With a full range of sizes, there is a label available for every application. The need for large inventories of custom preprinted labels and long lead times is eliminated, providing an economical solution to all of your labeling needs.

All labels in this section are roll mounted on 3.00" (76.2 mm) cores.



Self-Laminating Thermal Transfer Labels

- These labels are used most commonly for marking wires, cables, test tubes and other cylindrical objects in applications where a protective overlamine is needed.



Specialized Blank Thermal Transfer Labels

- Panduit offers labels in a variety of high performance materials for a wide range of applications from labeling circuit boards to asset management to wire identification. These labels are designed for specific purposes and are available in five materials to meet your application requirements.



Heat Shrink Labels

- Durable, high quality permanent heat shrink markers for wire and cable identification.
- Available in white and yellow for wire diameters from 0.04" to 1.00".



Thermal Transfer Ribbons

- Designed specifically for outstanding images in harsh environments on a wide spectrum of materials.
- Available in two types:
 - Resin for harsh environments
 - Wax for self-laminating labels, heat shrink labels and general purpose labeling

Suggested Applications for Thermal Transfer Labels:



Circuit Board Labeling

Recommended Materials

| Material | Color | Usage | Part Number Listing on Page |
|-----------------------------------|--------|------------------|-----------------------------|
| GMP4-W Paper | White | Indoor | 37 |
| GMY4-C Polyester | Clear | Indoor / Outdoor | 38 |
| GMY4-W Polyester | White | Indoor / Outdoor | 38 |
| GMY4-S Polyester | Silver | Indoor / Outdoor | 39 |
| GMY4-STE Tamper Evident Polyester | Silver | Indoor / Outdoor | 39 |
| GMPE4-W Destructible Polyethylene | White | Indoor | 37 |



Rating Plate Labeling

Recommended Materials

| Material | Color | Usage | Part Number Listing on Page |
|-----------------------------------|--------|------------------|-----------------------------|
| GMP4-W Paper | White | Indoor | 37 |
| GMY4-C Polyester | Clear | Indoor / Outdoor | 38 |
| GMY4-W Polyester | White | Indoor / Outdoor | 38 |
| GMY4-S Polyester | Silver | Indoor / Outdoor | 39 |
| GMY4-STE Tamper Evident Polyester | Silver | Indoor / Outdoor | 39 |
| GMPE4-W Destructible Polyethylene | White | Indoor | 37 |



Laboratory and Health Care Labeling

Recommended Materials

| Material | Color | Usage | Part Number Listing on Page |
|-----------------------------------|---------------|------------------|-----------------------------|
| GMP4-W Paper | White | Indoor | 37 |
| GMY4-C Polyester | Clear | Indoor / Outdoor | 38 |
| GMY4-W Polyester | White | Indoor / Outdoor | 38 |
| GMY4-STE Tamper Evident Polyester | Silver | Indoor / Outdoor | 39 |
| GMPE4-W Destructible Polyethylene | White | Indoor | 37 |
| GMV3 Self-Laminating Vinyl | White / Clear | Indoor | 36 |



Asset Labeling

Recommended Materials

| Material | Color | Usage | Part Number Listing on Page |
|-----------------------------------|--------|------------------|-----------------------------|
| GMP4-W Paper | White | Indoor | 37 |
| GMY4-C Polyester | Clear | Indoor / Outdoor | 38 |
| GMY4-W Polyester | White | Indoor / Outdoor | 38 |
| GMY4-S Polyester | Silver | Indoor / Outdoor | 39 |
| GMY4-STE Tamper Evident Polyester | Silver | Indoor / Outdoor | 39 |

Suggested Applications for Thermal Transfer Labels:



Bar Code Labeling

Recommended Materials

| Material | Color | Usage | Part Number Listing on Page |
|-----------------------------------|--------|------------------|-----------------------------|
| GMP4-W Paper | White | Indoor | 37 |
| GMV4-C Polyester | Clear | Indoor / Outdoor | 38 |
| GMV4-W Polyester | White | Indoor / Outdoor | 38 |
| GMV4-S Polyester | Silver | Indoor / Outdoor | 39 |
| GMV4-STE Tamper Evident Polyester | Silver | Indoor / Outdoor | 39 |



Wire and Cable Identification

Recommended Materials

| Material | Color | Usage | Part Number Listing on Page |
|----------------------------|---------------|------------------|-----------------------------|
| GMV3 Self-Laminating Vinyl | White / Clear | Indoor | 36 |
| GMT4-W TEDLAR * | White | Indoor / Outdoor | 39 |



Shipment Tracking

Recommended Materials

| Material | Color | Usage | Part Number Listing on Page |
|------------------|-------|------------------|-----------------------------|
| GMP4-W Paper | White | Indoor | 37 |
| GMV4-W Polyester | White | Indoor / Outdoor | 38 |



Network Systems Labeling

Recommended Materials

| Material | Color | Usage | Part Number Listing on Page |
|------------------|-------|------------------|-----------------------------|
| GMV4-W Polyester | White | Indoor / Outdoor | 40-41 |
| GMV4-C Polyester | Clear | Indoor / Outdoor | 41 |

*TEDLAR is the registered trademark of E. I. DuPont Co.

Thermal Transfer Material Selection Guide

Choose the material that best suits your application:

| Material Code | Material Type | Temperature Range | Key Features | Color | Outdoor Rated | Hazardous Environment | UL Rec. | CSA |
|---------------|----------------------------|---------------------------------|---|--------|---------------|-----------------------|---------|-----|
| GMV3 | Self-Laminating Vinyl Film | -40°F to 176°F (-40°C to 80°C) | General purpose vinyl self-laminating labels | Clear | No | No | Yes | Yes |
| GMP4-W | Destructible Paper | -65°F to 160°F (-54°C to 71°C) | Tamper resistant litho paper for permanent applications | White | No | No | No | No |
| GMPE4-W | Destructible Polyethylene | -40°F to 176°F (-40°C to 80°C) | Destructible adhesive for permanent applications | White | No | No | No | No |
| GMV4-C | Clear Polyester | -40°F to 302°F (-40°C to 150°C) | Durable; high temperature; does not stretch or easily tear | Clear | Yes | Yes | No | No |
| GMV4-W | White Polyester | -40°F to 302°F (-40°C to 150°C) | Durable; high temperature; does not stretch or easily tear | White | Yes | Yes | No | No |
| GMV4-S | Metallized Polyester | -40°F to 302°F (-40°C to 150°C) | Durable; high temperature; does not stretch or easily tear; protects data EPROM by blocking out light | Silver | Yes | Yes | No | No |
| GMV4-STE | Tamper Evident Polyester | -40°F to 104°F (-40°C to 40°C) | Destructible material; label cannot be completely removed once applied | Silver | Yes | No | No | No |
| GMT4-W | TEDLAR * | -40°F to 225°F (-40°C to 106°C) | Indoor/outdoor high temperature labels; Self-extinguishing | White | Yes | Yes | No | No |

*TEDLAR is the registered trademark of E. I. DuPont Co.

Self-Laminating Thermal Transfer Labels

GMV3 Self-Laminating Vinyl — Indoor Applications

Suggested Uses

- Laboratory and Health Care
- Wire and Cable Identification

Key Features

- General purpose self-laminating labels

| Part Number | Material | Print-On Area Color | Label Size Width x Length In. (mm) | Print-On Area Width x Length In. (mm) | Nominal Cable Outside Diameter * In. (mm) | Dwg. Page No. | Std. Pkg. Qty.* |
|----------------|----------------------------|---------------------|------------------------------------|---------------------------------------|---|---------------|-----------------|
| TTSL8VC3-10 | GMV3 Self-Laminating Vinyl | White | 0.50 x 0.75 (12.7 x 19.1) | 0.50 x 0.41 (12.7 x 10.4) | 0.10 (2.5) | 44 | 10,000 |
| TTSL1VC3-10 | | | 0.50 x 1.50 (12.7 x 38.1) | 0.50 x 0.50 (12.7 x 12.7) | 0.16 - 0.32 (4.1 - 8.1) | 44 | 10,000 |
| TTSL10VC3-5 | | | 0.50 x 2.00 (12.7 x 50.8) | 0.50 x 1.00 (12.7 x 25.4) | 0.32 (8.1) | 44 | 5000 |
| TTSL247VC3-10 | | | 0.80 x 0.94 (20.3 x 23.9) | 0.80 x 0.38 (20.3 x 9.6) | 0.12 - 0.18 (3.0 - 4.6) | 44 | 10,000 |
| TTSL9VC3-10 | | | 1.00 x 0.75 (25.4 x 19.1) | 1.00 x 0.38 (25.4 x 9.6) | 0.12 (3.0) | 44 | 10,000 |
| TTSL250VC3-2.5 | | | 1.00 x 0.94 (25.4 x 23.9) | 1.00 x 0.38 (25.4 x 9.6) | 0.12 - 0.18 (3.0 - 4.5) | 44 | 2500 |
| TTSL2VC3-10 | | | 1.00 x 1.50 (25.4 x 38.1) | 1.00 x 0.50 (25.4 x 12.7) | 0.16 - 0.32 (4.1 - 8.1) | 44 | 10,000 |
| TTSL4VC3-5 | | | 1.00 x 2.44 (25.4 x 62.0) | 1.00 x 1.00 (25.4 x 25.4) | 0.32 - 0.46 (8.1 - 11.6) | 44 | 5000 |
| TTSL6VC3-2.5 | | | 1.00 x 3.94 (25.4 x 100.1) | 1.00 x 1.00 (25.4 x 25.4) | 0.32 - 0.94 (8.1 - 23.8) | 44 | 2500 |
| TTSL3VC3-1 | | | 2.00 x 1.50 (50.8 x 38.1) | 2.00 x 0.50 (50.8 x 12.7) | 0.16 - 0.32 (4.1 - 8.1) | 44 | 1000 |
| TTSL7VC3-1 | | | 2.00 x 3.94 (50.8 x 100.1) | 2.00 x 1.00 (50.8 x 25.4) | 0.32 - 0.94 (8.1 - 23.8) | 44 | 1000 |

*Order number of labels required in multiples of Std. Pkg. Qty.

*Refer to Wire Size Selection Guide on page 196 to review diameters of commonly used cables

Blank Thermal Transfer Labels by Material

GMP4-W Paper — Indoor Applications

Key Features

- Tamper resistant litho paper for permanent applications

Suggested Uses

- Rating Plates
- Laboratory and Health Care
- Asset Identification
- Bar Code Labels
- Shipment Tracking
- Hazardous Material Identification

| Part Number | Material | Color | Label Size Width x Length In (mm) | Dwg. Page No. | Std. Pkg. Qty.* |
|-------------|-----------------------------|-------|-----------------------------------|---------------|-----------------|
| TTC15P-2.5 | GMP4-W Paper | White | 1.50 x 1.00 (38.1 x 25.4) | 42 | 2500 |
| TTC20P-2.5 | | | 2.00 x 1.00 (50.8 x 25.4) | 42 | 2500 |
| TTC21P-2.5 | | | 2.00 x 1.25 (50.8 x 31.8) | 42 | 2500 |
| TTC22P-2.5 | | | 2.75 x 1.25 (69.9 x 31.8) | 43 | 2500 |
| TTC46P-5 | | | 3.00 x 0.94 (76.2 x 23.8) | 43 | 5000 |
| TTC24P-2.5 | | | 3.00 x 1.00 (76.2 x 25.4) | 43 | 2500 |
| TTC25P-1 | | | 3.00 x 2.00 (76.2 x 50.8) | 43 | 1000 |
| TTC26P-1 | | | 3.00 x 5.00 (76.2 x 127.0) | 43 | 1000 |
| TTC31P-1 | | | 3.50 x 1.00 (88.9 x 25.4) | 43 | 1000 |
| TTC32P-1 | | | 3.50 x 8.00 (88.9 x 203.2) | 43 | 1000 |
| TTC34P-5 | | | 3.63 x 4.2 (92.1 x 107.1) | 43 | 500 |
| TTC33P-5 | | | 3.63 x 5.79 (92.1 x 147.1) | 43 | 500 |
| TTC35P-2.5 | | | 4.00 x 1.00 (101.6 x 25.4) | 43 | 2500 |
| TTC36P-1 | | | 4.00 x 2.00 (101.6 x 50.8) | 43 | 1000 |
| TTC37P-1 | | | 4.00 x 3.00 (101.6 x 76.2) | 43 | 1000 |
| TTC38P-1 | | | 4.00 x 4.00 (101.6 x 101.6) | 43 | 1000 |
| TTC39P-1 | | | 4.00 x 5.00 (101.6 x 127.0) | 43 | 1000 |
| TTC40P-1 | | | 4.00 x 6.00 (101.6 x 152.4) | 43 | 1000 |
| TTC41P-1 | | | 4.00 x 6.50 (101.6 x 165.1) | 43 | 1000 |
| TTC42P-5 | | | 4.00 x 12.88 (101.6 x 327.0) | 43 | 500 |
| TTC43P-1 | 5.00 x 4.00 (127.0 x 101.6) | 44 | 1000 | | |
| TTC44P-1 | 6.00 x 4.00 (152.4 x 101.6) | 44 | 1000 | | |

GMPE4-W Destructible Polyethylene — Indoor Applications

Key Features

- Tamper evident

Suggested Uses

- Circuit Board Labeling
- Rating Plates
- Laboratory and Health Care

| Part Number | Material | Color | Label Size Width x Length In (mm) | Dwg. Page No. | Std. Pkg. Qty.* |
|-------------|-----------------------------------|-------|-----------------------------------|---------------|-----------------|
| TTC8ET-10 | GMPE4-W Destructible Polyethylene | White | 1.00 x 0.50 (25.4 x 12.7) | 42 | 10,000 |

*Order number of labels required in multiples of Std. Pkg. Qty.

Blank Thermal Transfer Labels by Material (cont.)

GMY4-C Clear Polyester — Indoor/Outdoor Applications

Key Features

- Durable
- High temperature
- Does not stretch or easily tear

Suggested Uses

- Circuit Board Labeling
- Rating Plates
- Asset Identification
- Bar Code Labels

| Part Number | Material | Color | Label Size Width x Length In (mm) | Dwg. Page No. | Std. Pkg. Qty.* |
|-------------|------------------|-------|-----------------------------------|---------------|-----------------|
| TTC8YC-10 | GMY4-C Polyester | Clear | 1.00 x 0.50 (25.4 x 12.7) | 42 | 10,000 |
| TTC20YC-2.5 | | | 2.00 x 1.00 (50.8 x 25.4) | 42 | 2500 |
| TTC24YC-2.5 | | | 3.00 x 1.00 (76.2 x 25.4) | 43 | 2500 |
| TTC25YC-1 | | | 3.00 x 2.00 (76.2 x 50.8) | 43 | 1000 |

GMY4-W White Polyester — Indoor/Outdoor Applications

Key Features

- Durable
- High temperature
- Does not stretch or easily tear

Suggested Uses

- Circuit Board Labeling
- Rating Plates
- Laboratory and Health Care
- Asset Identification
- Bar Code Labels
- Shipment Tracking
- Hazardous Material Identification

| Part Number | Material | Color | Label Size Width x Length In (mm) | Dwg. Page No. | Std. Pkg. Qty.* |
|-------------|------------------|-------|-----------------------------------|---------------|-----------------|
| TTC1Y-10 | GMY4-W Polyester | White | 0.25 x 0.25 (6.4 x 6.4) | 42 | 10,000 |
| TTC2Y-10 | | | 0.38 x 0.38 (9.5 x 9.5) | 42 | 10,000 |
| TTC3Y-10 | | | 0.50 x 0.44 (12.7 x 11.1) | 42 | 10,000 |
| TTC45Y-1 | | | 0.50 x 0.75 (12.7 x 19.1) | 42 | 1000 |
| TTC4Y-10 | | | 0.65 x 0.20 (16.5 x 5.1) | 42 | 10,000 |
| TTC5Y-10 | | | 0.75 x 0.25 (19.1 x 6.4) | 42 | 10,000 |
| TTC6Y-10 | | | 0.90 x 0.25 (22.9 x 6.4) | 42 | 10,000 |
| TTC7Y-10 | | | 1.00 x 0.38 (25.4 x 9.5) | 42 | 10,000 |
| TTC8Y-10 | | | 1.00 x 0.50 (25.4 x 12.7) | 42 | 10,000 |
| TTC9Y-10 | | | 1.25 x 0.25 (31.8 x 6.4) | 42 | 10,000 |
| TTC10Y-10 | | | 1.25 x 0.38 (31.8 x 9.5) | 42 | 10,000 |
| TTC11Y-10 | | | 1.50 x 0.25 (38.1 x 6.4) | 42 | 10,000 |
| TTC12Y-10 | | | 1.50 x 0.50 (38.1 x 12.7) | 42 | 10,000 |
| TTC13Y-10 | | | 1.50 x 0.75 (38.1 x 19.1) | 42 | 10,000 |
| TTC14Y-2.5 | | | 1.50 x 0.81 (38.1 x 20.6) | 42 | 2500 |
| TTC15Y-2.5 | | | 1.50 x 1.00 (38.1 x 25.4) | 42 | 2500 |
| TTC16Y-2.5 | | | 1.50 x 1.13 (38.1 x 28.6) | 42 | 2500 |
| TTC17Y-2.5 | | | 1.63 x 1.25 (41.3 x 31.8) | 42 | 2500 |
| TTC18Y-2.5 | | | 2.00 x 0.25 (50.8 x 6.4) | 42 | 2500 |
| TTC19Y-2.5 | | | 2.00 x 0.50 (50.8 x 12.7) | 42 | 2500 |
| TTC20Y-2.5 | | | 2.00 x 1.00 (50.8 x 25.4) | 42 | 2500 |
| TTC22Y-2.5 | | | 2.75 x 1.25 (69.9 x 31.8) | 43 | 2500 |
| TTC23Y-2.5 | | | 3.00 x 0.25 (76.2 x 6.4) | 43 | 2500 |
| TTC24Y-2.5 | | | 3.00 x 1.00 (76.2 x 25.4) | 43 | 2500 |
| TTC25Y-1 | | | 3.00 x 2.00 (76.2 x 50.8) | 43 | 1000 |
| TTC27Y-10 | | | 3.25 x 0.31 (82.6 x 7.92) | 43 | 10,000 |
| TTC28Y-10 | | | 3.25 x 0.50 (82.6 x 12.7) | 43 | 10,000 |
| TTC29Y-5 | | | 3.25 x 0.63 (82.6 x 15.9) | 43 | 5000 |
| TTC30Y-2.5 | | | 3.25 x 0.81 (82.6 x 20.6) | 43 | 2500 |
| TTC31Y-1 | | | 3.50 x 1.00 (88.9 x 25.4) | 43 | 1000 |
| TTC32Y-1 | | | 3.50 x 8.00 (88.9 x 203.2) | 43 | 1000 |
| TTC35Y-2.5 | | | 4.00 x 1.00 (101.6 x 25.4) | 43 | 2500 |
| TTC36Y-1 | | | 4.00 x 2.00 (101.6 x 50.8) | 43 | 1000 |
| TTC37Y-1 | | | 4.00 x 3.00 (101.6 x 76.2) | 43 | 1000 |
| TTC38Y-1 | | | 4.00 x 4.00 (101.6 x 101.6) | 43 | 1000 |
| TTC39Y-1 | | | 4.00 x 5.00 (101.6 x 127.0) | 43 | 1000 |
| TTC41Y-1 | | | 4.00 x 6.50 (101.6 x 165.1) | 43 | 1000 |
| TTC42Y-5 | | | 4.00 x 12.88 (101.6 x 327.0) | 43 | 500 |
| TTC43Y-1 | | | 5.00 x 4.00 (127.0 x 101.6) | 44 | 1000 |
| TTC44Y-1 | | | 6.00 x 4.00 (152.4 x 101.6) | 44 | 1000 |

Blank Thermal Transfer Labels by Material (cont.)

GMY4-S Silver Polyester — Indoor/Outdoor Applications

Key Features

- Durable
- High temperature
- Does not stretch or easily tear
- Protects data EPROM by blocking out light

Suggested Uses

- Circuit Board Labeling
- Rating Plates
- Asset Identification
- Bar Code Labels

| Part Number | Material | Color | Label Size Width x Length In (mm) | Dwg. Page No. | Std. Pkg. Qty.* |
|-------------|------------------|--------|-----------------------------------|---------------|-----------------|
| TTC3YS-10 | GMY4-S Polyester | Silver | 0.50 x 0.44 (12.7 x 11.1) | 42 | 10,000 |
| TTC5YS-10 | | | 0.75 x 0.25 (19.1 x 6.4) | 42 | 10,000 |
| TTC7YS-10 | | | 1.00 x 0.38 (25.4 x 9.5) | 42 | 10,000 |
| TTC8YS-10 | | | 1.00 x 0.50 (25.4 x 12.7) | 42 | 10,000 |
| TTC13YS-10 | | | 1.50 x 0.75 (38.1 x 19.1) | 42 | 10,000 |
| TTC20YS-2.5 | | | 2.00 x 1.00 (50.8 x 25.4) | 42 | 2500 |
| TTC22YS-2.5 | | | 2.75 x 1.25 (69.9 x 31.8) | 43 | 2500 |
| TTC24YS-2.5 | | | 3.00 x 1.00 (76.2 x 25.4) | 43 | 2500 |
| TTC25YS-1 | | | 3.00 x 2.00 (76.2 x 50.8) | 43 | 1000 |
| TTC36YS-1 | | | 4.00 x 2.00 (101.6 x 50.8) | 43 | 1000 |

GMY4-STE Tamper Evident Polyester — Indoor/Outdoor Applications

Key Features

- Tamper evident

Suggested Uses

- Circuit Board Labeling
- Rating Plates
- Laboratory and Health Care
- Asset Identification

| Part Number | Material | Color | Label Size Width x Length In (mm) | Dwg. Page No. | Std. Pkg. Qty.* |
|--------------|-----------------------------------|--------|-----------------------------------|---------------|-----------------|
| TTC3YST-10 | GMY4-STE Tamper Evident Polyester | Silver | 0.50 x 0.44 (12.7 x 11.1) | 42 | 10,000 |
| TTC4YST-10 | | | 0.65 x 0.20 (16.5 x 5.1) | 42 | 10,000 |
| TTC5YST-10 | | | 0.75 x 0.25 (19.1 x 6.4) | 42 | 10,000 |
| TTC8YST-10 | | | 1.00 x 0.50 (25.4 x 12.7) | 42 | 10,000 |
| TTC20YST-2.5 | | | 2.00 x 1.00 (50.8 x 25.4) | 42 | 2500 |
| TTC24YST-2.5 | | | 3.00 x 1.00 (76.2 x 25.4) | 43 | 2500 |
| TTC25YST-1 | | | 3.00 x 2.00 (76.2 x 50.8) | 43 | 1000 |

GMT4-W TEDLAR ^ — Indoor/Outdoor Applications

Key Features

- High temperature
- Self-extinguishing

Suggested Uses

- Wire and Cable Identification
- Outdoor Applications

| Part Number | Material | Color | Label Size Width x Length In (mm) | Dwg. Page No. | Std. Pkg. Qty.* |
|-------------|-----------------|-------|-----------------------------------|---------------|-----------------|
| TTC4T-10 | GMT4-W TEDLAR ^ | White | 0.65 x 0.20 (16.5 x 5.1) | 42 | 10,000 |
| TTC5T-10 | | | 0.75 x 0.25 (19.1 x 6.4) | 42 | 10,000 |
| TTC6T-10 | | | 0.90 x 0.25 (22.9 x 6.4) | 42 | 10,000 |
| TTC8T-10 | | | 1.00 x 0.50 (25.4 x 12.7) | 42 | 10,000 |
| TTC10T-10 | | | 1.25 x 0.38 (31.8 x 9.5) | 42 | 10,000 |

*TEDLAR is the registered trademark of E. I. DuPont Co.

TIA/EIA-606 Compliant Network Systems Labeling



What is TIA/EIA-606?

TIA/EIA-606 is a standard from the Telecommunications Industry Association which requires labeling and administration of the telecommunication infrastructure in commercial buildings. TIA-606 applies to Cables, Connectors, Hub Facilities, Termination Facilities (Patch Panels), Conduits and Pathways.

Panduit manufactures a broad range of labeling products to help you conform to TIA/EIA-606.

Along with the labels already shown in this section, the following pages feature labels designed specifically for Network Systems Labeling.

*For more information on the complete line of **PAN-NET™** Network Cabling System Products, ask for the Communication Products Catalog.*

Termination Hardware Labeling



Adhesive 110 Punchdown Block Labels

- Eliminate the need for standard paper designation strips
- Labels are placed on top of label holders

| Part Number | Material | Color | Label Width In. (mm) | Label Length In. (mm) | Horizontal Repeat In. (mm) | Vertical Repeat In. (mm) | Labels Per Row | Web Width In. (mm) | Std. Pkg. Qty.* |
|-------------|------------------|-------|----------------------|-----------------------|----------------------------|--------------------------|----------------|--------------------|-----------------|
| TTC-DS110-5 | GMY4-W Polyester | White | 0.50 (12.7) | 7.88 (200.0) | — | 8.13 (206.4) | 1 | 1.25 (31.8) | 500 |

*Order number of labels required in multiples of Std. Pkg. Qty.



Adhesive Label for Patch Panels and Modular Furniture Faceplates

- Label is perforated on black lines to be used in 2 position, 4 position, or 6 position applications

| Part Number | Material | Color | Label Width In. (mm) | Label Length In. (mm) | Horizontal Repeat In. (mm) | Vertical Repeat In. (mm) | Labels Per Row | Web Width In. (mm) | Std. Pkg. Qty.* |
|-------------|------------------|-------|----------------------|-----------------------|----------------------------|--------------------------|----------------|--------------------|-----------------|
| TTC-CPL-1 | GMY4-W Polyester | White | 0.33 (8.4) | 0.61 (15.5) | 0.33 (8.4) | 0.61 (15.5) | 1 | 1.25 (31.8) | 1000 |

*Order number of labels required in multiples of Std. Pkg. Qty.

Network Systems Labeling — Termination Position Labeling



MINI-JACK™ Modular Jack and OPTI-JACK™ Fiber Optic Connector Labels

- Identify individual jacks and connectors
- Wrap around design allows for quick and secure installation
- Labels attach directly to jacks

| Part Number | Material | Color | Label Width In. (mm) | Label Length In. (mm) | Horizontal Repeat In. (mm) | Vertical Repeat In. (mm) | Labels Per Row | Web Width In. (mm) | Std. Pkg. Qty.* |
|-------------|----------------|-------|----------------------|-----------------------|----------------------------|--------------------------|----------------|--------------------|-----------------|
| TTC-MJ-5 | GMY4 Polyester | Clear | 1.38 (34.9) | 0.19 (4.8) | — | 0.38 (9.5) | 1 | 2.25 (57.2) | 5000 |
| TTC-MJWH-5 | | White | | | | | | | |

*Order number of labels required in multiples of Std. Pkg. Qty.



Faceplate Adhesive Labels

- For use with **MINI-COM**® Executive and Designer Series Faceplates
- Designed to fit on vinyl insert provided with faceplate
- Single and Double Gang versions available
- Can also be used to identify **MINI-COM** Surface Mount Boxes

| Part Number | Faceplate Type | Material | Color | Label Width In. (mm) | Label Length In. (mm) | Horizontal Repeat In. (mm) | Vertical Repeat In. (mm) | Labels Per Row | Web Width In. (mm) | Std. Pkg. Qty.* |
|--------------|----------------|------------------|-------|----------------------|-----------------------|----------------------------|--------------------------|----------------|--------------------|-----------------|
| TTC-EFPL-1 | Single Gang | GMY4-W Polyester | White | 1.80 (45.7) | 0.38 (9.5) | — | 0.63 (15.9) | 1 | 2.25 (57.2) | 1000 |
| TTC-EFPLC-1 | | | Clear | | | | | | | |
| TTC-EFPL10-1 | Double Gang | | White | 2.90 (73.7) | 0.30 (7.6) | — | 0.55 (14.0) | 1 | 3.25 (82.6) | 1000 |

*Order number of labels required in multiples of Std. Pkg. Qty.

For more information on the complete line of **PAN-NET**™ Network Cabling System Products, ask for the Communication Products Catalog.

Blank Thermal Transfer Labels by Size



| Part Number | Material | Color | Label Width A In. (mm) | Label Length B In. (mm) | Horizontal Repeat D In. (mm) | Vertical Repeat E In. (mm) | Labels Per Row | Web Width F In. (mm) | Std. Pkg. Qty.* |
|--------------|---------------------------|--------|---------------------------|----------------------------|---------------------------------|-------------------------------|----------------|-------------------------|-----------------|
| TTC1Y-10 | Polyester | White | 0.25 (6.4) | 0.25 (6.4) | 0.25 (6.4) | 0.38 (9.5) | 12 | 3.20 (81.3) | 10,000 |
| TTC-CPL-1 | Polyester | White | 0.33 (8.4) | 0.61 (15.5) | 0.33 (8.4) | 0.61 (15.5) | 1 | 1.25 (31.8) | 1000 |
| TTC2Y-10 | Polyester | White | 0.38 (9.5) | 0.38 (9.5) | 0.44 (11.1) | 0.48 (12.1) | 7 | 3.20 (81.3) | 10,000 |
| TTC3YS-10 | Polyester | Silver | 0.50 (12.7) | 0.44 (11.1) | 0.66 (16.8) | 0.48 (12.1) | 5 | 3.35 (85.1) | 10,000 |
| TTC3Y-10 | Polyester | White | 0.50 (12.7) | 0.44 (11.1) | 0.66 (16.8) | 0.48 (12.1) | 5 | 3.35 (85.1) | 10,000 |
| TTC3YST-10 | Tamper Evident Polyester | Silver | 0.50 (12.7) | 0.44 (11.1) | 0.66 (16.8) | 0.48 (12.1) | 5 | 3.35 (85.1) | 10,000 |
| TTC45Y-1 | Polyester | White | 0.50 (12.7) | 0.75 (19.1) | 0.50 (12.7) | 0.88 (22.2) | 1 | 4.25 (108.0) | 1000 |
| TTC-DS110-.5 | Polyester | White | 0.50 (12.7) | 7.88 (200.0) | — | 8.13 (206.4) | 1 | 1.25 (31.8) | 500 |
| TTC4Y-10 | Polyester | White | 0.65 (16.5) | 0.20 (5.1) | 0.70 (17.8) | 0.28 (7.0) | 4 | 2.95 (74.9) | 10,000 |
| TTC4YST-10 | Tamper Evident Polyester | Silver | 0.65 (16.5) | 0.20 (5.1) | 0.70 (17.8) | 0.28 (7.0) | 4 | 2.95 (74.9) | 10,000 |
| TTC4T-10 | TEDLAR [▲] | White | 0.65 (16.5) | 0.20 (5.1) | 0.70 (17.8) | 0.28 (7.0) | 4 | 2.95 (74.9) | 10,000 |
| TTC5YS-10 | Polyester | Silver | 0.75 (19.1) | 0.25 (6.4) | 0.80 (20.3) | 0.35 (8.9) | 4 | 3.35 (85.1) | 10,000 |
| TTC5Y-10 | Polyester | White | 0.75 (19.1) | 0.25 (6.4) | 0.80 (20.3) | 0.35 (8.9) | 4 | 3.35 (85.1) | 10,000 |
| TTC5YST-10 | Tamper Evident Polyester | Silver | 0.75 (19.1) | 0.25 (6.4) | 0.80 (20.3) | 0.35 (8.9) | 4 | 3.35 (85.1) | 10,000 |
| TTC5T-10 | TEDLAR | White | 0.75 (19.1) | 0.25 (6.4) | 0.80 (20.3) | 0.35 (8.9) | 4 | 3.35 (85.1) | 10,000 |
| TTC6Y-10 | Polyester | White | 0.90 (22.9) | 0.25 (6.4) | 1.13 (28.6) | 0.35 (8.9) | 3 | 3.35 (85.1) | 10,000 |
| TTC6T-10 | TEDLAR | White | 0.90 (22.9) | 0.25 (6.4) | 1.13 (28.6) | 0.35 (8.9) | 3 | 3.35 (85.1) | 10,000 |
| TTC7YS-10 | Polyester | Silver | 1.00 (25.4) | 0.38 (9.5) | 1.08 (27.3) | 0.48 (12.1) | 3 | 3.35 (85.1) | 10,000 |
| TTC7Y-10 | Polyester | White | 1.00 (25.4) | 0.38 (9.5) | 1.08 (27.3) | 0.48 (12.1) | 3 | 3.35 (85.1) | 10,000 |
| TTC8ET-10 | Destructible Polyethylene | White | 1.00 (25.4) | 0.50 (12.7) | 1.08 (27.3) | 0.60 (15.2) | 3 | 3.35 (85.1) | 10,000 |
| TTC8YS-10 | Polyester | Silver | 1.00 (25.4) | 0.50 (12.7) | 1.08 (27.3) | 0.60 (15.2) | 3 | 3.35 (85.1) | 10,000 |
| TTC8YC-10 | Polyester | Clear | 1.00 (25.4) | 0.50 (12.7) | 1.08 (27.3) | 0.63 (15.9) | 3 | 3.35 (85.1) | 10,000 |
| TTC8Y-10 | Polyester | White | 1.00 (25.4) | 0.50 (12.7) | 1.08 (27.3) | 0.60 (15.2) | 3 | 3.35 (85.1) | 10,000 |
| TTC8YST-10 | Tamper Evident Polyester | Silver | 1.00 (25.4) | 0.50 (12.7) | 1.08 (27.3) | 0.60 (15.2) | 3 | 3.35 (85.1) | 10,000 |
| TTC8T-10 | TEDLAR | White | 1.00 (25.4) | 0.50 (12.7) | 1.08 (27.3) | 0.60 (15.2) | 3 | 3.35 (85.1) | 10,000 |
| TTC9Y-10 | Polyester | White | 1.25 (31.8) | 0.25 (6.4) | 1.30 (33.0) | 0.38 (9.5) | 2 | 2.75 (69.9) | 10,000 |
| TTC10Y-10 | Polyester | White | 1.25 (31.8) | 0.38 (9.5) | 1.30 (33.0) | 0.48 (12.1) | 2 | 2.75 (69.9) | 10,000 |
| TTC10T-10 | TEDLAR | White | 1.25 (31.8) | 0.38 (9.5) | 1.30 (33.0) | 0.48 (12.1) | 2 | 2.75 (69.9) | 10,000 |
| TTC-MJ-5 | Polyester | Clear | 1.38 (34.9) | 0.19 (4.8) | — | 0.38 (9.5) | 1 | 2.25 (57.2) | 5000 |
| TTC-MJWH-5 | Polyester | White | 1.38 (34.9) | 0.19 (4.8) | — | 0.38 (9.5) | 1 | 2.25 (57.2) | 5000 |
| TTC11Y-10 | Polyester | White | 1.50 (38.1) | 0.25 (6.4) | 1.65 (41.9) | 0.35 (8.9) | 2 | 3.35 (85.1) | 10,000 |
| TTC12Y-10 | Polyester | White | 1.50 (38.1) | 0.50 (12.7) | 1.65 (41.9) | 0.63 (15.9) | 2 | 3.35 (85.1) | 10,000 |
| TTC13YS-10 | Polyester | Silver | 1.50 (38.1) | 0.75 (19.1) | 1.65 (41.9) | 0.88 (22.2) | 2 | 3.35 (85.1) | 10,000 |
| TTC13Y-10 | Polyester | White | 1.50 (38.1) | 0.75 (19.1) | 1.65 (41.9) | 0.88 (22.2) | 2 | 3.35 (85.1) | 10,000 |
| TTC14Y-2.5 | Polyester | White | 1.50 (38.1) | 0.81 (20.6) | 1.65 (41.9) | 0.94 (23.8) | 2 | 3.35 (85.1) | 2500 |
| TTC15P-2.5 | Paper | White | 1.50 (38.1) | 1.00 (25.4) | — | 1.63 (41.3) | 1 | 1.75 (44.5) | 2500 |
| TTC15Y-2.5 | Polyester | White | 1.50 (38.1) | 1.00 (25.4) | — | 1.63 (41.3) | 1 | 1.75 (44.5) | 2500 |
| TTC16Y-2.5 | Polyester | White | 1.50 (38.1) | 1.13 (28.6) | 1.65 (41.9) | 1.25 (31.8) | 2 | 3.35 (85.1) | 2500 |
| TTC17Y-2.5 | Polyester | White | 1.63 (41.3) | 1.25 (31.8) | — | 1.38 (34.9) | 1 | 2.20 (55.9) | 2500 |
| TTC-EFPLC-1 | Polyester | Clear | 1.80 (45.7) | 0.38 (9.5) | — | 0.63 (15.9) | 1 | 2.25 (57.2) | 1000 |
| TTC-EFPL-1 | Polyester | White | 1.80 (45.7) | 0.38 (9.5) | — | 0.63 (15.9) | 1 | 2.25 (57.2) | 1000 |
| TTC18Y-2.5 | Polyester | White | 2.00 (50.8) | 0.25 (6.4) | — | 0.38 (9.5) | 1 | 2.20 (55.9) | 2500 |
| TTC19Y-2.5 | Polyester | White | 2.00 (50.8) | 0.50 (12.7) | — | 0.60 (15.2) | 1 | 2.20 (55.9) | 2500 |
| TTC20YS-2.5 | Polyester | Silver | 2.00 (50.8) | 1.00 (25.4) | — | 1.13 (28.6) | 1 | 2.20 (55.9) | 2500 |
| TTC20P-2.5 | Paper | White | 2.00 (50.8) | 1.00 (25.4) | — | 1.13 (28.6) | 1 | 2.20 (55.9) | 2500 |
| TTC20YC-2.5 | Polyester | Clear | 2.00 (50.8) | 1.00 (25.4) | — | 1.13 (28.6) | 1 | 2.20 (55.9) | 2500 |
| TTC20Y-2.5 | Polyester | White | 2.00 (50.8) | 1.00 (25.4) | — | 1.13 (28.6) | 1 | 2.20 (55.9) | 2500 |
| TTC20YST-2.5 | Tamper Evident Polyester | Silver | 2.00 (50.8) | 1.00 (25.4) | — | 1.13 (28.6) | 1 | 2.20 (55.9) | 2500 |
| TTC21P-2.5 | Paper | White | 2.00 (50.8) | 1.25 (31.8) | — | 1.38 (34.9) | 1 | 2.20 (55.9) | 2500 |

Thermal Transfer Labels

Blank Thermal Transfer Labels by Size (cont.)



| Part Number | Material | Color | Label Width A In. (mm) | Label Length B In. (mm) | Horizontal Repeat D In. (mm) | Vertical Repeat E In. (mm) | Labels Per Row | Web Width F In. (mm) | Std. Pkg. Qty.* |
|--------------|--------------------------|--------|---------------------------|----------------------------|---------------------------------|-------------------------------|----------------|-------------------------|-----------------|
| TTC22YS-2.5 | Polyester | Silver | 2.75 (69.9) | 1.25 (31.8) | — | 1.38 (34.9) | 1 | 2.95 (74.9) | 2500 |
| TTC22P-2.5 | Paper | White | 2.75 (69.9) | 1.25 (31.8) | — | 1.38 (34.9) | 1 | 2.95 (74.9) | 2500 |
| TTC22Y-2.5 | Polyester | White | 2.75 (69.9) | 1.25 (31.8) | — | 1.38 (34.9) | 1 | 2.95 (74.9) | 2500 |
| TTC-EFPL10-1 | Polyester | White | 2.90 (73.7) | 0.30 (7.6) | — | 0.55 (14.0) | 1 | 3.25 (82.6) | 1000 |
| TTC23Y-2.5 | Polyester | White | 3.00 (76.2) | 0.25 (6.4) | — | 0.38 (9.5) | 1 | 3.20 (81.3) | 2500 |
| TTC46P-5 | Paper | White | 3.00 (76.2) | 0.94 (23.8) | — | 1.06 (27.0) | 1 | 3.35 (85.1) | 5000 |
| TTC24YS-2.5 | Polyester | Silver | 3.00 (76.2) | 1.00 (25.4) | — | 1.13 (28.6) | 1 | 3.20 (81.3) | 2500 |
| TTC24P-2.5 | Paper | White | 3.00 (76.2) | 1.00 (25.4) | — | 1.13 (28.6) | 1 | 3.20 (81.3) | 2500 |
| TTC24YC-2.5 | Polyester | Clear | 3.00 (76.2) | 1.00 (25.4) | — | 1.13 (28.6) | 1 | 3.20 (81.3) | 2500 |
| TTC24Y-2.5 | Polyester | White | 3.00 (76.2) | 1.00 (25.4) | — | 1.13 (28.6) | 1 | 3.20 (81.3) | 2500 |
| TTC24YST-2.5 | Tamper Evident Polyester | Silver | 3.00 (76.2) | 1.00 (25.4) | — | 1.13 (28.6) | 1 | 3.20 (81.3) | 2500 |
| TTC25YS-1 | Polyester | Silver | 3.00 (76.2) | 2.00 (50.8) | — | 2.13 (54.0) | 1 | 3.20 (81.3) | 1000 |
| TTC25P-1 | Paper | White | 3.00 (76.2) | 2.00 (50.8) | — | 2.13 (54.0) | 1 | 3.20 (81.3) | 1000 |
| TTC25YC-1 | Polyester | Clear | 3.00 (76.2) | 2.00 (50.8) | — | 2.13 (54.0) | 1 | 3.20 (81.3) | 1000 |
| TTC25Y-1 | Polyester | White | 3.00 (76.2) | 2.00 (50.8) | — | 2.13 (54.0) | 1 | 3.20 (81.3) | 1000 |
| TTC25YST-1 | Tamper Evident Polyester | Silver | 3.00 (76.2) | 2.00 (50.8) | — | 2.13 (54.0) | 1 | 3.20 (81.3) | 1000 |
| TTC26P-1 | Paper | White | 3.00 (76.2) | 5.00 (127.0) | — | 5.13 (130.2) | 1 | 3.20 (81.3) | 1000 |
| TTC27Y-10 | Polyester | White | 3.25 (82.6) | 0.31 (7.9) | — | 0.44 (11.1) | 1 | 4.20 (106.7) | 10,000 |
| TTC28Y-10 | Polyester | White | 3.25 (82.6) | 0.50 (12.7) | — | 0.63 (15.9) | 1 | 4.20 (106.7) | 10,000 |
| TTC29Y-5 | Polyester | White | 3.25 (82.6) | 0.63 (15.9) | — | 0.75 (19.1) | 1 | 4.20 (106.7) | 5000 |
| TTC30Y-2.5 | Polyester | White | 3.25 (82.6) | 0.81 (20.6) | — | 0.94 (23.8) | 1 | 4.20 (106.7) | 2500 |
| TTC31P-1 | Paper | White | 3.50 (88.9) | 1.00 (25.4) | — | 1.13 (28.6) | 1 | 3.75 (95.3) | 1000 |
| TTC31Y-1 | Polyester | White | 3.50 (88.9) | 1.00 (25.4) | — | 1.13 (28.6) | 1 | 3.75 (95.3) | 1000 |
| TTC32P-1 | Paper | White | 3.50 (88.9) | 8.00 (203.2) | — | 8.13 (206.4) | 1 | 3.75 (95.3) | 1000 |
| TTC32Y-1 | Polyester | White | 3.50 (88.9) | 8.00 (203.2) | — | 8.13 (206.4) | 1 | 3.75 (95.3) | 1000 |
| TTC34P-.5 | Paper | White | 3.63 (92.1) | 4.20 (107.1) | — | 4.34 (110.3) | 1 | 4.20 (106.7) | 500 |
| TTC33P-.5 | Paper | White | 3.63 (92.1) | 5.79 (147.1) | — | 5.92 (150.3) | 1 | 4.20 (106.7) | 500 |
| TTC35P-2.5 | Paper | White | 4.00 (101.6) | 1.00 (25.4) | — | 4.13 (104.8) | 1 | 4.20 (106.7) | 2500 |
| TTC35Y-2.5 | Polyester | White | 4.00 (101.6) | 1.00 (25.4) | — | 4.13 (104.8) | 1 | 4.20 (106.7) | 2500 |
| TTC36YS-1 | Polyester | Silver | 4.00 (101.6) | 2.00 (50.8) | — | 2.13 (54.0) | 1 | 4.20 (106.7) | 1000 |
| TTC36P-1 | Paper | White | 4.00 (101.6) | 2.00 (50.8) | — | 2.13 (54.0) | 1 | 4.20 (106.7) | 1000 |
| TTC36Y-1 | Polyester | White | 4.00 (101.6) | 2.00 (50.8) | — | 2.13 (54.0) | 1 | 4.20 (106.7) | 1000 |
| TTC37P-1 | Paper | White | 4.00 (101.6) | 3.00 (76.2) | — | 3.13 (79.4) | 1 | 4.20 (106.7) | 1000 |
| TTC37Y-1 | Polyester | White | 4.00 (101.6) | 3.00 (76.2) | — | 3.13 (79.4) | 1 | 4.20 (106.7) | 1000 |
| TTC38P-1 | Paper | White | 4.00 (101.6) | 4.00 (101.6) | — | 4.13 (104.8) | 1 | 4.20 (106.7) | 1000 |
| TTC38Y-1 | Polyester | White | 4.00 (101.6) | 4.00 (101.6) | — | 4.13 (104.8) | 1 | 4.20 (106.7) | 1000 |
| TTC39P-1 | Paper | White | 4.00 (101.6) | 5.00 (127.0) | — | 5.13 (130.2) | 1 | 4.20 (106.7) | 1000 |
| TTC39Y-1 | Polyester | White | 4.00 (101.6) | 5.00 (127.0) | — | 5.13 (130.2) | 1 | 4.20 (106.7) | 1000 |
| TTC40P-1 | Paper | White | 4.00 (101.6) | 6.00 (152.4) | — | 6.06 (154.0) | 1 | 4.20 (106.7) | 1000 |
| TTC41P-1 | Paper | White | 4.00 (101.6) | 6.50 (165.1) | — | 6.63 (168.3) | 1 | 4.20 (106.7) | 1000 |
| TTC41Y-1 | Polyester | White | 4.00 (101.6) | 6.50 (165.1) | — | 6.63 (168.3) | 1 | 4.20 (106.7) | 1000 |
| TTC42P-.5 | Paper | White | 4.00 (101.6) | 12.88 (327.0) | — | 13.00 (330.2) | 1 | 4.20 (106.7) | 500 |
| TTC42Y-.5 | Polyester | White | 4.00 (101.6) | 12.88 (327.0) | — | 13.00 (330.2) | 1 | 4.20 (106.7) | 500 |

Labels are roll mounted on 3.00" (76.2 mm) core.
*Order number of labels required in multiples of Std. Pkg. Qty.

Blank Thermal Transfer Labels by Size (cont.)



| Part Number | Material | Color | Label Width A In. (mm) | Label Length B In. (mm) | Horizontal Repeat D In. (mm) | Vertical Repeat E In. (mm) | Labels Per Row | Web Width F In. (mm) | Std. Pkg. Qty.* |
|-------------|-----------|-------|---------------------------|----------------------------|---------------------------------|-------------------------------|----------------|-------------------------|-----------------|
| TTC43P-1 | Paper | White | 5.00 (127.0) | 4.00 (101.6) | — | 4.13 (104.8) | 1 | 5.20 (132.1) | 1000 |
| TTC43Y-1 | Polyester | White | 5.00 (127.0) | 4.00 (101.6) | — | 4.13 (104.8) | 1 | 5.20 (132.1) | 1000 |
| TTC44P-1 | Paper | White | 6.00 (152.4) | 4.00 (101.6) | — | 4.13 (104.8) | 1 | 6.20 (157.5) | 1000 |
| TTC44Y-1 | Polyester | White | 6.00 (152.4) | 4.00 (101.6) | — | 4.13 (104.8) | 1 | 6.20 (157.5) | 1000 |

Self-Laminating Thermal Transfer Labels by Size



| Part Number | Material | Print-On Area Color | Label Width A In. (mm) | Label Length B In. (mm) | Print-On Length C In. (mm) | Horizontal Repeat D In. (mm) | Vertical Repeat E In. (mm) | Labels Per Row | Web Width F In. (mm) | Std. Pkg. Qty.* |
|----------------|----------|---------------------|---------------------------|----------------------------|-------------------------------|---------------------------------|-------------------------------|----------------|-------------------------|-----------------|
| TTSL8VC3-10 | GMV3 SL | White | 0.50 (12.7) | 0.75 (19.1) | 0.41 (10.4) | 0.50 (12.7) | 0.88 (22.2) | 8 | 4.25 (108.0) | 10,000 |
| TTSL1VC3-10 | GMV3 SL | White | 0.50 (12.7) | 1.50 (38.1) | 0.50 (12.7) | 0.50 (12.7) | 1.80 (45.7) | 8 | 4.25 (108.0) | 10,000 |
| TTSL10VC3-5 | GMV3 SL | White | 0.50 (12.7) | 2.00 (50.8) | 1.00 (25.4) | 0.50 (12.7) | 2.13 (54.0) | 4 | 4.25 (108.0) | 5000 |
| TTSL247VC3-10 | GMV3 SL | White | 0.80 (20.3) | 0.94 (23.9) | 0.38 (9.6) | 0.80 (20.3) | 1.25 (31.8) | 5 | 4.25 (108.0) | 10,000 |
| TTSL9VC3-10 | GMV3 SL | White | 1.00 (25.4) | 0.75 (19.1) | 0.35 (8.9) | 1.00 (25.4) | 0.88 (22.2) | 4 | 4.25 (108.0) | 10,000 |
| TTSL250VC3-2.5 | GMV3 SL | White | 1.00 (25.4) | 0.94 (23.9) | 0.38 (9.6) | 1.00 (25.4) | 1.25 (31.8) | 4 | 4.25 (108.0) | 2500 |
| TTSL2VC3-10 | GMV3 SL | White | 1.00 (25.4) | 1.50 (38.1) | 0.50 (12.7) | 1.00 (25.4) | 1.80 (45.7) | 4 | 4.25 (108.0) | 10,000 |
| TTSL4VC3-5 | GMV3 SL | White | 1.00 (25.4) | 2.44 (62.0) | 1.00 (25.4) | 1.00 (25.4) | 2.83 (72.0) | 4 | 4.25 (108.0) | 5000 |
| TTSL6V3-2.5 | GMV3 SL | White | 1.00 (25.4) | 3.94 (100.1) | 1.00 (25.4) | 1.00 (25.4) | 4.25 (108.0) | 4 | 4.25 (108.0) | 2500 |
| TTSL3VC3-1 | GMV3 SL | White | 2.00 (50.8) | 1.50 (38.1) | 0.50 (12.7) | 2.00 (50.8) | 1.80 (45.7) | 2 | 4.25 (108.0) | 1000 |
| TTSL7VC3-1 | GMV3 SL | White | 2.00 (50.8) | 3.94 (100.1) | 1.00 (25.4) | 2.00 (50.8) | 4.25 (108.0) | 2 | 4.25 (108.0) | 1000 |



Heat Shrink Wire and Cable Markers

- Produce durable, high quality permanent heat shrink markers
- Pre-cut tubing mounted on plastic carrier
- Service Temperature Range: -22°F to 220°F (-30°C to 105°C)
- Shrink Ratio 3:1 @ 212°F (100°C)
- Flammability: Meets U.L. Standard 224 for flammability
- Panduit Heat Shrink Tools and Accessories shown on [page 123](#)
- For best results use with Panduit Wax Thermal Transfer Ribbons shown on [page 46](#)

| Part Number | Diameter In. (mm) | Marker Width In. (mm) | Markers Per Row | Nominal Cable Outside Diameter [■] In. (mm) | Material | Color | Mkrs Per Roll | Std. Pkg. Qty.* |
|-------------|-------------------|-----------------------|-----------------|--|--------------------------------|--------|---------------|-----------------|
| LHS12W1 | 0.13 (3.2) | 2.00 (50.8) | 1 | 0.04 - 0.13 (1.1 - 3.2) | 3:1 Flattened Polyolefin | White | 500 | 1 Roll |
| LHS12W2 | 0.13 (3.2) | 1.00 (25.4) | 2 | | | | 1000 | 1 Roll |
| LHS12W4 | 0.13 (3.2) | 0.50 (12.7) | 4 | | | | 2000 | 1 Roll |
| LHS18W1 | 0.18 (4.8) | 2.00 (50.8) | 1 | 0.06 - 0.18 (1.6 - 4.8) | | | 500 | 1 Roll |
| LHS18W2 | 0.18 (4.8) | 1.00 (25.4) | 2 | | | | 1000 | 1 Roll |
| LHS18W4 | 0.18 (4.8) | 0.50 (12.7) | 4 | | | | 2000 | 1 Roll |
| LHS25W1 | 0.25 (6.4) | 2.00 (50.8) | 1 | 0.08 - 0.25 (2.1 - 6.4) | | 500 | 1 Roll | |
| LHS25W2 | 0.25 (6.4) | 1.00 (25.4) | 2 | | | 1000 | 1 Roll | |
| LHS25W4 | 0.25 (6.4) | 0.50 (12.7) | 4 | | | 2000 | 1 Roll | |
| LHS50W1 | 0.50 (12.7) | 2.00 (50.8) | 1 | 0.17 - 0.50 (4.2 - 12.7) | | 500 | 1 Roll | |
| LHS50W2 | 0.50 (12.7) | 1.00 (25.4) | 2 | | | 1000 | 1 Roll | |
| LHS100W1 | 1.00 (25.4) | 2.00 (50.8) | 1 | 0.33 - 1.00 (8.4 - 25.4) | | 250 | 1 Roll | |
| LHS100W2 | 1.00 (25.4) | 1.00 (25.4) | 2 | | 500 | 1 Roll | | |
| LHS12Y1 | 0.13 (3.2) | 2.00 (50.8) | 1 | 0.04 - 0.13 (1.1 - 3.2) | 3:1 Flattened Polyolefin | Yellow | 500 | 1 Roll |
| LHS12Y2 | 0.13 (3.2) | 1.00 (25.4) | 2 | | | | 1000 | 1 Roll |
| LHS12Y4 | 0.13 (3.2) | 0.50 (12.7) | 4 | | | | 2000 | 1 Roll |
| LHS18Y1 | 0.18 (4.8) | 2.00 (50.8) | 1 | 0.06 - 0.18 (1.6 - 4.8) | | | 500 | 1 Roll |
| LHS18Y2 | 0.18 (4.8) | 1.00 (25.4) | 2 | | | | 1000 | 1 Roll |
| LHS18Y4 | 0.18 (4.8) | 0.50 (12.7) | 4 | | | | 2000 | 1 Roll |
| LHS25Y1 | 0.25 (6.4) | 2.00 (50.8) | 1 | 0.08 - 0.25 (2.1 - 6.4) | | 500 | 1 Roll | |
| LHS25Y2 | 0.25 (6.4) | 1.00 (25.4) | 2 | | | 1000 | 1 Roll | |
| LHS25Y4 | 0.25 (6.4) | 0.50 (12.7) | 4 | | | 2000 | 1 Roll | |
| LHS50Y1 | 0.50 (12.7) | 2.00 (50.8) | 1 | 0.17 - 0.50 (4.2 - 12.7) | | 500 | 1 Roll | |
| LHS50Y2 | 0.50 (12.7) | 1.00 (25.4) | 2 | | | 1000 | 1 Roll | |
| LHS100Y1 | 1.00 (25.4) | 2.00 (50.8) | 1 | 0.33 - 1.00 (8.4 - 25.4) | | 250 | 1 Roll | |
| LHS100Y2 | 1.00 (25.4) | 1.00 (25.4) | 2 | | 500 | 1 Roll | | |

[■]Refer to Wire Size Selection Guide on [page 196](#) to review diameters of commonly used cables
^{*}Order number of rolls required in multiples of Std. Pkg. Qty.

Thermal Transfer Ribbons



Designed specifically for outstanding images in harsh environments on a wide spectrum of materials.

Available in two types:

- Resin for harsh environments
- Wax for general purpose labeling

High Performance Resin Ribbons

Key Features

- Excellent durability
- High speed (up to 12 inches per second)
- Extended print head life because they use a low heat setting

Resistant To

- Gasoline, Alcohol, Abrasion, UV Light, Other Chemicals (contact factory for detailed technical data)

Perfect For

- Electrical / Electronic Marking
- Rating Plate Labeling
- Laboratory and Health Care Labeling
- Automotive Identification
- Asset Labeling
- Shelf Labeling
- Shipment Tracking

General Purpose Wax Ribbons

Key Features

- Economical
- High print speed (up to 12 inches per second)
- Recommended for printing on Panduit Self-Laminating Labels (see [pg. 36](#)) and Heat Shrink Labels (see [pg. 45](#))

Perfect For

- General Purpose Labeling
- Product Labeling
- Graphics
- Inventory Labeling
- Shipment Tracking

| Ribbon Style | Width In. (mm) | Length Ft. (m) | Type | Color | Part Number | Std. Pkg. Qty.* |
|--------------|----------------|----------------|-------|-------|-------------|-----------------|
| E | 2.50 (63.5) | 280 (85.3) | Resin | Black | TTR2-BL | 1 |
| | | | Resin | White | TTR2-WH | |
| | | | Wax | Black | TTRW2-BL | |
| | 4.33 (110.0) | | Resin | Black | TTR-BL | |
| | | | Resin | White | TTR-WH | |
| | | | Wax | Black | TTRW-BL | |
| S | 4.33 (110.0) | 1181 (360.0) | Resin | Black | TTR4-BL-S | |
| | | | Wax | Black | TTR4W-BL-S | |
| | 6.50 (165.1) | | Resin | Black | TTR6-BL-S | |
| | | | Wax | Black | TTR6W-BL-S | |
| Z | 4.33 (110.0) | 984 (300.0) | Resin | Black | TTR4-BL-Z | |
| | | | Wax | Black | TTR4W-BL-Z | |
| | 6.50 (165.1) | | Resin | Black | TTR6-BL-Z | |
| | | | Wax | Black | TTR6W-BL-Z | |

*Order number of ribbons required in multiples of Std. Pkg. Qty.

To determine which ribbon style is designed for your printer, see chart on the following page.

Thermal Transfer Ribbons

Use the chart below to determine which ribbon style is designed for your printer. See previous page for part numbers available in each style.

| Printer | Ribbon Style (see pg. 46) |
|---|------------------------------|
| A | |
| Acumark 3000 | S |
| Allegro | S |
| Antonson 407 | Z |
| Astromed LC 5000 | S |
| Atec Swedot 201, 205 | S |
| Atech 196 | Z |
| Auto Label XT-500 | S |
| Avery Dennison 3000, 3500, 3520, 4200, 4500, 5000, 5300, 5350, TLP 40, TLP 46 | S |
| B | |
| Brady 200 Series, 300 Series | Z |
| Brady 2024, 2034 | S |
| C | |
| C. Itoh T-4 | S |
| Codewriter 5106 | Z |
| Codewriter Legacy, UTICoder 2104T | S |
| Cognitive Solutions Blazer | S |
| Computer Identics | Z |
| Computype Sigma | S |
| Comstar, All | S |
| D | |
| Data Ply 909, 989, 990 | S |
| Datamax, All | S |
| DH Technology Blaster Advantage | S |
| Diagraph, All | S |
| DPC 5207 | S |
| E | |
| Eltron 2242 | E |
| F | |
| Facit T400 | Z |
| Fargo, All | S |
| I | |
| Imtec 3100, 3130, 3500 | Z |
| Intacs 3528 | S |
| Intermec 3400, 3600, 4000, 4100 | S |
| K | |
| Kimball MEQ 1634 | S |

| Printer | Ribbon Style (see pg. 46) |
|--|------------------------------|
| L | |
| Label Jet 2600 | S |
| Labelaire 2136, 2137-P, 2138 | S |
| Labelaire 2137-Z | Z |
| Lowery 4090, 4130, 4140, 4142, 4220 | Z |
| Lowery 4120, 4121 | S |
| M | |
| Markem SK 4200 | Z |
| Mars MEQ 1634 | S |
| Matthews 1300 | Z |
| Matthews 4100, 4101 | S |
| N | |
| Novexx, All | S |
| P | |
| Panduit PTR2 | E |
| Panduit PTR3 | S |
| Printstar 90-130 | Z |
| R | |
| RJS, All except near edge printers | Z |
| Ring, All | Z |
| S | |
| Sato, All | S |
| Soabar SPX 30, 320, 350, 360, 362, 370, 380, 386, 390, Travier | S |
| Swedot 196 | Z |
| T | |
| Tharo, All | S |
| U | |
| Universal DP1300, DP2300 | Z |
| Unimark V300, 301, 340, 400, 420, 500, 522 | S |
| W | |
| Weber 75, 76 | S |
| Weber Legtronic 78, 79, 80, 81,82, 85, 86, 93 | Z |
| Willett 2600, 2610, 8400, 8450 | S |
| Willett 2603 | Z |
| Z | |
| Zebra, All | Z |

Contact factory for information on printer models not listed.



Panduit offers high quality ink jet labels in a variety of materials, sizes and styles.

Panduit Ink Jet Labels are used for a wide variety of identification purposes including bar code labeling, asset identification and shipment tracking. The wide range of label sizes available provides a label for every application. The need for large inventories of custom preprinted labels and long lead times is eliminated, providing an economical solution to all of your labeling needs. Labels are supplied on 8.50" x 11.00" (215.9 x 279.4 mm) sheets.

Smear resistant ink jet cartridges and refills are also available to provide optimal smear resistance. The ink is formulated for superior performance with Panduit Ink Jet Label Coatings.



Self-Laminating Ink Jet Labels

- These labels are used most commonly for marking wires, cables, test tubes and other cylindrical objects in applications where a protective overlaminate is needed.



Specialized Blank Ink Jet Labels

- Panduit offers labels in a variety of high performance materials for a wide range of applications from labeling circuit boards to asset management to wire identification. These labels are designed for specific purposes and are available in four materials to meet your application requirements.

Suggested Applications for Ink Jet Labels



Electronic Labeling

Recommended Materials

| Material | Color | Usage | Part Number Listing on Page |
|--------------------|-------|--------|-----------------------------|
| GMC5-W Vinyl Cloth | White | Indoor | 53 |



Bar Code and General Labeling

Recommended Materials

| Material | Color | Usage | Part Number Listing on Page |
|---------------------------|-------|--------|-----------------------------|
| GMP5-W Destructible Paper | White | Indoor | 51 |
| GM5-W Polyester | White | Indoor | 52 |



Shipment Tracking Labels

Recommended Materials

| Material | Color | Usage | Part Number Listing on Page |
|---------------------------|-------|--------|-----------------------------|
| GMP5-W Destructible Paper | White | Indoor | 51 |
| GM5-W Polyester | White | Indoor | 52 |



Network Systems Labeling

Recommended Materials

| Material | Color | Usage | Part Number Listing on Page |
|--------------------|-------|--------|-----------------------------|
| GMPO5-W Polyolefin | White | Indoor | 53 |

Ink Jet Labels

Ink Jet Material Selection Guide

Choose the material that best suits your application:

| Material Code | Material Type | Temperature Range | Key Features | Color | Outdoor Rated | Hazardous Environment | UL Rec. | CSA |
|---------------|--------------------|---------------------------------|---|-------|---------------|-----------------------|---------|-----|
| GMP5-W | Destructible Paper | -65°F to 200°F (-54°C to 93°C) | Tamper resistant litho paper for permanent applications | White | No | No | No | No |
| GMPO5-W | Polyolefin | -50°F to 120°F (-46°C to 49°C) | Durable, pliable material with permanent adhesive | White | No | No | No | No |
| GMC5-W | Vinyl Cloth | -50°F to 170°F (-46°C to 77°C) | Repositionable adhesive; pliable material good for rough, textured surfaces | White | No | No | No | No |
| GMY5-W | White Polyester | -40°F to 311°F (-40°C to 154°C) | Durable; high temperature; does not stretch or tear | White | No | No | No | No |

Self-Laminating Ink Jet Labels

- Clear overlamine protects legend for permanent, clean identification
- Ideal for wire and cable marking

| Part Number | Material | Print-On Area Color | Label Size Width x Length In. (mm) | Print-On Area Width x Length In. (mm) | Nominal Cable Outside Diameter " In. (mm) | Dwg. Page No. | Std. Pkg. Qty.* |
|-------------|---------------------------|---------------------|------------------------------------|---------------------------------------|---|---------------|-----------------|
| JSL1-Y3-5 | Self-Laminating Polyester | White | 0.50 x 0.75 (12.7 x 19.1) | 0.50 x 0.34 (12.7 x 8.6) | 0.11 - 0.13 (2.8 - 3.3) | 54 | 5000 |
| JSL2-Y3-5 | | | 0.50 x 1.50 (12.7 x 38.1) | 0.50 x 0.50 (12.7 x 12.7) | 0.16 - 0.32 (4.0 - 8.1) | 54 | 5000 |
| JSL9-Y3-2.5 | | | 0.70 x 1.33 (17.8 x 33.8) | 0.70 x 0.33 (17.8 x 8.4) | 0.10 - 0.32 (2.7 - 8.1) | 54 | 2500 |
| JSL10-Y3-1 | | | 0.90 x 2.17 (22.9 x 55.1) | 0.90 x 0.50 (22.9 x 12.7) | 0.16 - 0.53 (4.0 - 13.5) | 54 | 1000 |
| JSL3-Y3-2.5 | | | 1.00 x 0.75 (25.4 x 19.1) | 1.00 x 0.34 (25.4 x 8.6) | 0.11 - 0.13 (2.8 - 3.3) | 54 | 2500 |
| JSL4-Y3-2.5 | | | 1.00 x 1.00 (25.4 x 25.4) | 1.00 x 0.34 (25.4 x 8.6) | 0.11 - 0.21 (2.8 - 5.3) | 54 | 2500 |
| JSL5-Y3-2.5 | | | 1.00 x 1.33 (25.4 x 33.8) | 1.00 x 0.47 (25.4 x 11.9) | 0.15 - 0.27 (3.8 - 6.9) | 54 | 2500 |
| JSL11-Y3-1 | | | 1.00 x 2.67 (25.4 x 67.8) | 1.00 x 0.67 (25.4 x 16.9) | 0.21 - 0.64 (5.4 - 16.2) | 54 | 1000 |
| JSL6-Y3-1 | | | 1.00 x 3.17 (25.4 x 80.5) | 1.00 x 0.97 (25.4 x 24.6) | 0.31 - 0.70 (7.8 - 17.8) | 54 | 1000 |
| JSL12-Y3-1 | | | 1.20 x 2.67 (30.5 x 67.8) | 1.20 x 0.83 (30.5 x 21.1) | 0.26 - 0.58 (6.7 - 14.9) | 54 | 1000 |
| JSL7-Y3-1 | | | 2.00 x 1.50 (50.8 x 38.1) | 2.00 x 0.50 (50.8 x 12.7) | 0.16 - 0.32 (4.0 - 8.1) | 54 | 1000 |
| JSL8-Y3-1 | | | 2.00 x 3.17 (50.8 x 80.5) | 2.00 x 1.00 (50.8 x 25.4) | 0.32 - 0.69 (8.1 - 17.5) | 54 | 1000 |

*Refer to Wire Size Selection Guide on [page 196](#) to review diameters of commonly used cables

Blank Ink Jet Labels by Material

GMP5-W Destructible Paper—Indoor Applications

Key Features

- Tamper resistant litho paper for permanent applications
- Most economical labeling solution

Suggested Uses

- Bar Code and General Labeling
- Shipment Tracking
- Short term applications

| Part Number | Material | Color | Label Size Width x Length In. (mm) | Dwg. Page No. | Std. Pkg. Qty.* |
|-------------|---------------------------|-------|------------------------------------|---------------|-----------------|
| JL7P-10 | GMP5-W Destructible Paper | White | 0.25 x 1.00 (6.4 x 25.4) | 55 | 10,000 |
| JL8P-10 | | | 0.38 x 1.00 (9.5 x 25.4) | 55 | 10,000 |
| JL172P-10 | | | 0.50 x 0.80 (12.7 x 20.3) | 55 | 10,000 |
| JL9P-10 | | | 0.50 x 1.00 (12.7 x 25.4) | 55 | 10,000 |
| JL12P-5 | | | 0.50 x 1.50 (12.7 x 38.1) | 55 | 5000 |
| JL10P-5 | | | 0.75 x 1.00 (19.1 x 25.4) | 55 | 5000 |
| JL35P-2.5 | | | 0.75 x 1.50 (19.1 x 38.1) | 55 | 2500 |
| JL17P-2.5 | | | 0.83 x 1.88 (21.2 x 47.6) | 56 | 2500 |
| JL902P-2.5 | | | 1.00 x 1.75 (25.4 x 44.5) | 56 | 2500 |
| JL903P-0.5 | | | 2.75 x 2.75 (69.9 x 69.9) | 56 | 500 |
| JL25P-SH | | | 8.50 x 11.00 (215.9 x 279.4) | 56 | 25 |

*Order number of labels required in multiples of Std. Pkg. Qty.

Blank Ink Jet Labels by Material (cont.)

GMPO5-W Polyolefin—Indoor Applications

Key Features

- Provides excellent print quality
- Perfect for flat or curved surfaces
- Adhesive becomes permanent on most surfaces after 24 hours

Suggested Uses

- Asset Labeling
- Tool Check-In and Check-Out

| Part Number | Material | Color | Label Size Width x Length In. (mm) | Dwg. Page No. | Std. Pkg. Qty.* |
|-------------|--------------------|-------|------------------------------------|---------------|-----------------|
| JL7PO-10 | GMPO5-W Polyolefin | White | 0.25 x 1.00 (6.4 x 25.4) | 55 | 10,000 |
| JL14PO-10 | | | 0.25 x 1.50 (6.4 x 38.1) | 55 | 10,000 |
| JLEFPD-1 | | | 0.30 x 2.90 (7.6 x 73.7) | 55 | 1000 |
| JL8PO-10 | | | 0.38 x 1.00 (9.5 x 25.4) | 55 | 10,000 |
| JL16PO-2.5 | | | 0.38 x 1.88 (9.5 x 47.6) | 55 | 2500 |
| JL19PO-1 | | | 0.38 x 3.00 (9.5 x 76.2) | 55 | 1000 |
| JL9PO-10 | | | 0.50 x 1.00 (12.7 x 25.4) | 55 | 10,000 |
| JL24PO-5 | | | 0.56 x 0.19 (14.3 x 4.8) | 55 | 5000 |
| JL23PO-1 | | | 0.56 x 0.56 (14.3 x 14.3) | 55 | 1000 |
| JLCPL-1 | | | 0.61 x 0.33 (15.5 x 8.4) | 55 | 1000 |
| JL901PO-5 | | | 0.75 x 1.25 (19.1 x 31.8) | 55 | 5000 |
| JL35PO-2.5 | | | 0.75 x 1.50 (19.1 x 38.1) | 55 | 2500 |
| JL42PO-1 | | | 0.80 x 1.50 (20.3 x 38.1) | 56 | 1000 |
| JL17PO-1 | | | 0.83 x 1.88 (21.2 x 47.6) | 56 | 1000 |
| JL17PO-2.5 | | | 0.83 x 1.88 (21.2 x 47.6) | 56 | 2500 |
| JL412PO-1 | | | 1.38 x 0.19 (34.9 x 4.8) | 56 | 1000 |
| JL33PO-2.5 | | | 1.44 x 0.50 (36.5 x 12.7) | 56 | 2500 |
| JLEFPS-1 | | | 1.80 x 0.38 (45.7 x 9.5) | 56 | 1000 |
| JL18PO-1 | | | 1.88 x 1.33 (47.8 x 33.8) | 56 | 1000 |
| JL41PO-0.5 | | | 2.00 x 0.90 (50.8 x 22.9) | 56 | 500 |
| JL22PO-1 | | | 7.88 x 0.50 (200.0 x 12.7) | 56 | 1000 |

GM5-W Polyester—Indoor Applications

Key Features

- Tough polyester provides excellent durability and UV resistance
- Adhesive becomes permanent on most surfaces after 24 hours
- Does not stretch or easily tear

Suggested Uses

- High Performance labeling
- Bar Code and General labeling
- Inventory Tracking

| Part Number | Material | Color | Label Size Width x Length In. (mm) | Dwg. Page No. | Std. Pkg. Qty.* |
|-------------|-----------------|-------|------------------------------------|---------------|-----------------|
| JL32Y-10 | GM5-W Polyester | White | 0.20 x 0.65 (5.1 x 16.5) | 55 | 10,000 |
| JL4Y-10 | | | 0.25 x 0.65 (6.4 x 16.5) | 55 | 10,000 |
| JL274Y-10 | | | 0.25 x 0.75 (6.4 x 19.1) | 55 | 10,000 |
| JL5Y-10 | | | 0.25 x 0.80 (6.4 x 20.3) | 55 | 10,000 |
| JL287Y-10 | | | 0.25 x 0.90 (6.4 x 22.9) | 55 | 10,000 |
| JL7Y-10 | | | 0.25 x 1.00 (6.4 x 25.4) | 55 | 10,000 |
| JL14Y-10 | | | 0.25 x 1.50 (6.4 x 38.1) | 55 | 10,000 |
| JL15Y-10 | | | 0.25 x 1.88 (6.4 x 47.6) | 55 | 10,000 |
| JL2Y-10 | | | 0.38 x 0.38 (9.5 x 9.5) | 55 | 10,000 |
| JL8Y-10 | | | 0.38 x 1.00 (9.5 x 25.4) | 55 | 10,000 |
| JL16Y-5 | | | 0.38 x 1.88 (9.5 x 47.6) | 55 | 5000 |
| JL111Y-5 | | | 0.38 x 2.00 (9.5 x 50.8) | 55 | 5000 |
| JL19Y-2.5 | | | 0.38 x 3.00 (9.5 x 76.2) | 55 | 2500 |
| JL172Y-10 | | | 0.50 x 0.80 (12.7 x 20.3) | 55 | 10,000 |
| JL9Y-10 | | | 0.50 x 1.00 (12.7 x 25.4) | 55 | 10,000 |
| JL12Y-5 | | | 0.50 x 1.50 (12.7 x 38.1) | 55 | 5000 |
| JL3Y-10 | | | 0.75 x 0.50 (19.1 x 12.7) | 55 | 10,000 |
| JL10Y-5 | | | 0.75 x 1.00 (19.1 x 25.4) | 55 | 5000 |
| JL901Y-5 | | | 0.75 x 1.25 (19.1 x 31.8) | 55 | 5000 |
| JL35Y-2.5 | | | 0.75 x 1.50 (19.1 x 38.1) | 55 | 2500 |
| JL17Y-2.5 | | | 0.83 x 1.88 (21.2 x 47.6) | 56 | 2500 |
| JL902Y-2.5 | | | 1.00 x 1.75 (25.4 x 44.5) | 56 | 2500 |
| JL33Y-5 | | | 1.44 x 0.50 (36.5 x 12.7) | 56 | 5000 |
| JL25Y-SH | | | 8.50 x 11.00 (215.9 x 279.4) | 56 | 25 |

Blank Ink Jet Labels by Material (cont.)

GMC5-W Vinyl Cloth, Repositionable Adhesive—Indoor Applications

Key Features

- Repositionable adhesive ideal for identification of chips, boards and other electronic labeling
- Label removes with no sticky residue
- Pliable

Suggested Uses

- Electronic Labeling
- Good for rough, textured surfaces

| Part Number | Material | Color | Label Size Width x Length In. (mm) | Dwg. Page No. | Std. Pkg. Qty.* |
|-------------|--------------------|-------|------------------------------------|---------------|-----------------|
| JL32C-10 | GMC5-W Vinyl Cloth | White | 0.20 x 0.65 (5.1 x 16.5) | 55 | 10,000 |
| JL14C-10 | | | 0.25 x 1.50 (6.4 x 38.1) | 55 | 10,000 |
| JL8C-10 | | | 0.38 x 1.00 (9.5 x 25.4) | 55 | 10,000 |
| JL111C-5 | | | 0.38 x 2.00 (9.5 x 50.8) | 55 | 5000 |
| JL9C-10 | | | 0.50 x 1.00 (12.7 x 25.4) | 55 | 10,000 |
| JL3C-10 | | | 0.75 x 0.50 (19.1 x 12.7) | 55 | 10,000 |
| JL10C-5 | | | 0.75 x 1.00 (19.1 x 25.4) | 55 | 5000 |
| JL901C-5 | | | 0.75 x 1.25 (19.1 x 31.8) | 55 | 5000 |
| JL35C-2.5 | | | 0.75 x 1.50 (19.1 x 38.1) | 55 | 2500 |
| JL33C-5 | | | 1.44 x 0.50 (36.5 x 12.7) | 56 | 5000 |
| JL900C-2.5 | | | 1.44 x 0.80 (36.5 x 20.3) | 56 | 2500 |

TIA/EIA-606 Compliant Network Systems Labeling



Adhesive 110 Punchdown Block Labels

- Eliminate the need for standard paper designation strips
- Labels are placed on top of label holders

| Part Number | Material | Color | Label Width In. (mm) | Label Length In. (mm) | Labels Per Sheet | Std. Pkg. Qty.* |
|-------------|--------------------|-------|----------------------|-----------------------|------------------|-----------------|
| JL22PO-1 | GMPO5-W Polyolefin | White | 7.88 (200.0) | 0.50 (12.7) | 15 | 1000 |

*Order number of labels required in multiples of Std. Pkg. Qty.



Adhesive Label for Patch Panels and Modular Furniture Faceplates

- Label is perforated on black lines to be used in 2 position, 4 position, or 6 position applications

| Part Number | Material | Color | Label Width In. (mm) | Label Length In. (mm) | Labels Per Sheet | Std. Pkg. Qty.* |
|-------------|--------------------|-------|----------------------|-----------------------|------------------|-----------------|
| JLCPL-1 | GMPO5-W Polyolefin | White | 0.61 (15.5) | 0.33 (8.4) | 276 | 1000 |

*Order number of labels required in multiples of Std. Pkg. Qty.



Faceplate Adhesive Labels

- For use with **MINI-COM®** Executive and Designer Series Faceplates
- Designed to fit on vinyl insert provided with faceplate
- Single and Double Gang versions available
- Can also be used to identify **MINI-COM** Surface Mount Boxes

| Part Number | Faceplate Type | Material | Color | Label Width In. (mm) | Label Length In. (mm) | Labels Per Sheet | Std. Pkg. Qty.* |
|-------------|----------------|--------------------|-------|----------------------|-----------------------|------------------|-----------------|
| JLEFPS-1 | Single Gang | GMPO5-W Polyolefin | White | 1.80 (45.7) | 0.38 (9.5) | 84 | 1000 |
| JLEFPD-1 | Double Gang | | White | 0.30 (7.6) | 2.90 (73.7) | 63 | 1000 |

*Order number of labels required in multiples of Std. Pkg. Qty.

Smear Resistant Ink Jet Cartridges and Refills

- Recommended for use with Panduit Ink Jet Labels to provide optimal smear resistance
- Ink is formulated for superior performance with our ink jet label coatings
- Cartridges and refill kits are available for Hewlett Packard^ HP500 and HP600 printers
- Standard ink jet inks may be used, but may not provide best smear resistance characteristics

^Hewlett Packard is a registered trademark of Hewlett Packard Company

| Part Number | Description | Std. Pkg. Qty.* |
|-------------|---------------------|-----------------|
| JT500 | Cartridge for H500 | 1 |
| JT600 | Cartridge for HP600 | 1 |
| JTK | Refill Kit | 1 |
| JT1 | Ink for Refills | 1 |

*Order number required in multiples of Std. Pkg. Qty.

Self-Laminating Ink Jet Labels by Size

- For best results use with Panduit Smear Resistant Ink Jet Cartridges and Refills.

Note: Panduit Ink Jet Labels are designed for light to medium ink coverage. Graphics or heavy ink coverage may result in smearing, ink bleed or excessive dry time.

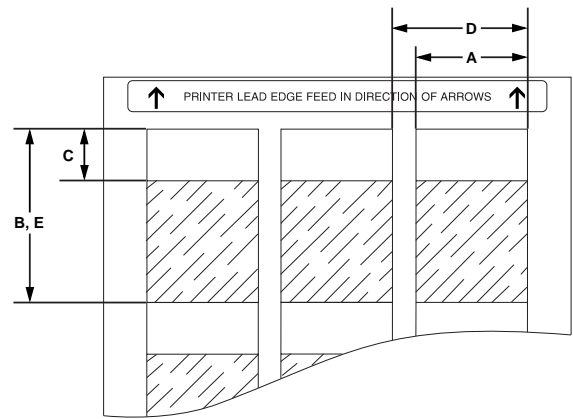

| Part Number | Material | Print-On Area Color | Label Width A In. (mm) | Label Length B In. (mm) | Print-On Area Length C In. (mm) | Horizontal Repeat D In. (mm) | Vertical Repeat E In. (mm) | No. of Col. | No. of Rows | Labels Per Sheet | Sheets Per Pkg. | Std. Pkg. Qty.* |
|-------------|---------------------------|---------------------|------------------------|-------------------------|---------------------------------|------------------------------|----------------------------|-------------|-------------|------------------|-----------------|-----------------|
| JSL1-Y3-5 | Self-Laminating Polyester | White | 0.50 (12.7) | 0.75 (19.1) | 0.34 (8.6) | 0.60 (15.2) | 0.75 (19.1) | 13 | 12 | 156 | 33 | 5000 |
| JSL2-Y3-5 | | | 0.50 (12.7) | 1.50 (38.1) | 0.50 (12.7) | 0.60 (15.2) | 1.50 (38.1) | 13 | 6 | 78 | 65 | 5000 |
| JSL9-Y3-2.5 | | | 0.70 (17.8) | 1.33 (33.8) | 0.33 (8.4) | 0.70 (17.8) | 1.33 (33.8) | 10 | 8 | 80 | 32 | 2500 |
| JSL10-Y3-1 | | | 0.90 (22.9) | 2.17 (55.1) | 0.50 (12.7) | 0.90 (22.9) | 2.17 (55.1) | 8 | 5 | 40 | 25 | 1000 |
| JSL3-Y3-2.5 | | | 1.00 (25.4) | 0.75 (19.1) | 0.34 (8.6) | 1.10 (27.9) | 0.75 (19.1) | 7 | 12 | 84 | 30 | 2500 |
| JSL4-Y3-2.5 | | | 1.00 (25.4) | 1.00 (25.4) | 0.34 (8.6) | 1.10 (27.9) | 1.00 (25.4) | 7 | 10 | 70 | 36 | 2500 |
| JSL5-Y3-2.5 | | | 1.00 (25.4) | 1.33 (33.8) | 0.47 (11.9) | 1.10 (27.9) | 1.33 (33.8) | 7 | 7 | 49 | 52 | 2500 |
| JSL11-Y3-1 | | | 1.00 (25.4) | 2.67 (67.8) | 0.67 (16.9) | 1.00 (25.4) | 2.67 (67.8) | 7 | 4 | 28 | 36 | 1000 |
| JSL6-Y3-1 | | | 1.00 (25.4) | 3.17 (80.5) | 0.97 (24.6) | 1.10 (27.9) | 3.17 (80.5) | 7 | 3 | 21 | 48 | 1000 |
| JSL12-Y3-1 | | | 1.20 (30.5) | 2.67 (67.8) | 0.83 (21.1) | 1.20 (30.5) | 2.67 (67.8) | 6 | 4 | 24 | 42 | 1000 |
| JSL7-Y3-1 | | | 2.00 (50.8) | 1.50 (38.1) | 0.50 (12.7) | 2.00 (50.8) | 1.50 (38.1) | 4 | 6 | 24 | 42 | 1000 |
| JSL8-Y3-1 | | | 2.00 (50.8) | 3.17 (80.5) | 1.00 (25.4) | 2.50 (63.5) | 3.17 (80.5) | 3 | 3 | 9 | 112 | 1000 |

*Order number of labels required in multiples of Std. Pkg. Qty.

Blank Ink Jet Labels by Size



| Part Number | Material | Color | Label Width A In. (mm) | Label Length B In. (mm) | Horizontal Repeat D In. (mm) | Vertical Repeat E In. (mm) | No. of Col. | No. of Rows | Labels Per Sheet | Sheets Per Pkg. | Std. Pkg. Qty. * |
|-------------|--------------------|-------|---------------------------|----------------------------|---------------------------------|-------------------------------|-------------|-------------|------------------|-----------------|------------------|
| JL32C-10 | Vinyl Cloth | White | 0.20 (5.1) | 0.65 (16.5) | 0.31 (7.8) | 0.74 (18.8) | 26 | 13 | 338 | 30 | 10,000 |
| JL32Y-10 | Polyester | White | 0.20 (5.1) | 0.65 (16.5) | 0.31 (7.8) | 0.74 (18.8) | 26 | 13 | 338 | 30 | 10,000 |
| JL4Y-10 | Polyester | White | 0.25 (6.4) | 0.65 (16.5) | 0.32 (8.1) | 0.74 (18.8) | 25 | 13 | 325 | 31 | 10,000 |
| JL274Y-10 | Polyester | White | 0.25 (6.4) | 0.75 (19.1) | 0.32 (8.1) | 0.85 (21.6) | 25 | 11 | 275 | 37 | 10,000 |
| JL5Y-10 | Polyester | White | 0.25 (6.4) | 0.80 (20.3) | 0.31 (7.9) | 0.87 (22.1) | 25 | 11 | 275 | 37 | 10,000 |
| JL287Y-10 | Polyester | White | 0.25 (6.4) | 0.90 (22.9) | 0.32 (8.1) | 0.97 (24.6) | 25 | 10 | 250 | 40 | 10,000 |
| JL7P-10 | Destructible Paper | White | 0.25 (6.4) | 1.00 (25.4) | 0.32 (8.1) | 1.07 (27.2) | 25 | 9 | 225 | 45 | 10,000 |
| JL7PO-10 | Polyolefin | White | 0.25 (6.4) | 1.00 (25.4) | 0.32 (8.1) | 1.07 (27.2) | 25 | 9 | 225 | 45 | 10,000 |
| JL7Y-10 | Polyester | White | 0.25 (6.4) | 1.00 (25.4) | 0.32 (8.1) | 1.07 (27.2) | 25 | 9 | 225 | 45 | 10,000 |
| JL14C-10 | Vinyl Cloth | White | 0.25 (6.4) | 1.50 (38.1) | 0.32 (8.1) | 1.63 (41.3) | 25 | 6 | 150 | 67 | 10,000 |
| JL14PO-10 | Polyolefin | White | 0.25 (6.4) | 1.50 (38.1) | 0.32 (8.1) | 1.63 (41.3) | 25 | 6 | 150 | 67 | 10,000 |
| JL14Y-10 | Polyester | White | 0.25 (6.4) | 1.50 (38.1) | 0.32 (8.1) | 1.63 (41.3) | 25 | 6 | 150 | 67 | 10,000 |
| JL15Y-10 | Polyester | White | 0.25 (6.4) | 1.88 (47.6) | 0.32 (8.1) | 1.95 (49.4) | 25 | 5 | 125 | 80 | 10,000 |
| JLEFPD-1 | Polyolefin | White | 0.30 (7.6) | 2.90 (73.7) | 0.38 (9.5) | 3.30 (83.8) | 21 | 3 | 63 | 16 | 1000 |
| JL2Y-10 | Polyester | White | 0.38 (9.5) | 0.38 (9.5) | 0.47 (11.9) | 0.45 (11.6) | 17 | 21 | 357 | 29 | 10,000 |
| JL8C-10 | Vinyl Cloth | White | 0.38 (9.5) | 1.00 (25.4) | 0.47 (11.9) | 1.07 (27.2) | 17 | 9 | 153 | 66 | 10,000 |
| JL8P-10 | Destructible Paper | White | 0.38 (9.5) | 1.00 (25.4) | 0.47 (11.9) | 1.07 (27.2) | 17 | 9 | 153 | 66 | 10,000 |
| JL8PO-10 | Polyolefin | White | 0.38 (9.5) | 1.00 (25.4) | 0.47 (11.9) | 1.07 (27.2) | 17 | 9 | 153 | 66 | 10,000 |
| JL8Y-10 | Polyester | White | 0.38 (9.5) | 1.00 (25.4) | 0.47 (11.9) | 1.07 (27.2) | 17 | 9 | 153 | 66 | 10,000 |
| JL16PO-2.5 | Polyolefin | White | 0.38 (9.5) | 1.88 (47.6) | 0.47 (11.9) | 1.95 (49.4) | 17 | 5 | 85 | 30 | 2500 |
| JL16Y-5 | Polyester | White | 0.38 (9.5) | 1.88 (47.6) | 0.47 (11.9) | 1.95 (49.4) | 17 | 5 | 85 | 59 | 5000 |
| JL111C-5 | Vinyl Cloth | White | 0.38 (9.5) | 2.00 (50.8) | 0.47 (11.9) | 2.25 (57.2) | 17 | 4 | 68 | 74 | 5000 |
| JL111Y-5 | Polyester | White | 0.38 (9.5) | 2.00 (50.8) | 0.47 (11.9) | 2.25 (57.2) | 17 | 4 | 68 | 74 | 5000 |
| JL19PO-1 | Polyolefin | White | 0.38 (9.5) | 3.00 (76.2) | 0.47 (11.9) | 3.20 (81.3) | 17 | 3 | 51 | 20 | 1000 |
| JL19Y-2.5 | Polyester | White | 0.38 (9.5) | 3.00 (76.2) | 0.47 (11.9) | 3.20 (81.3) | 17 | 3 | 51 | 50 | 2500 |
| JL172P-10 | Destructible Paper | White | 0.50 (12.7) | 0.80 (20.3) | 0.57 (14.5) | 0.87 (22.1) | 14 | 11 | 154 | 65 | 10,000 |
| JL172Y-10 | Polyester | White | 0.50 (12.7) | 0.80 (20.3) | 0.57 (14.5) | 0.87 (22.1) | 14 | 11 | 154 | 65 | 10,000 |
| JL9C-10 | Vinyl Cloth | White | 0.50 (12.7) | 1.00 (25.4) | 0.57 (14.5) | 1.07 (27.2) | 14 | 9 | 126 | 80 | 10,000 |
| JL9P-10 | Destructible Paper | White | 0.50 (12.7) | 1.00 (25.4) | 0.57 (14.5) | 1.07 (27.2) | 14 | 9 | 126 | 80 | 10,000 |
| JL9PO-10 | Polyolefin | White | 0.50 (12.7) | 1.00 (25.4) | 0.57 (14.5) | 1.07 (27.2) | 14 | 9 | 126 | 80 | 10,000 |
| JL9Y-10 | Polyester | White | 0.50 (12.7) | 1.00 (25.4) | 0.57 (14.5) | 1.07 (27.2) | 14 | 9 | 126 | 80 | 10,000 |
| JL12P-5 | Destructible Paper | White | 0.50 (12.7) | 1.50 (38.1) | 0.57 (14.5) | 1.63 (41.3) | 14 | 6 | 84 | 60 | 5000 |
| JL12Y-5 | Polyester | White | 0.50 (12.7) | 1.50 (38.1) | 0.57 (14.5) | 1.63 (41.3) | 14 | 6 | 84 | 60 | 5000 |
| JL24PO-5 | Polyolefin | White | 0.56 (14.3) | 0.19 (4.8) | 0.66 (16.8) | 0.25 (6.4) | 12 | 38 | 456 | 11 | 5000 |
| JL23PO-1 | Polyolefin | White | 0.56 (14.3) | 0.56 (14.3) | 0.66 (16.8) | 0.64 (16.2) | 12 | 15 | 180 | 6 | 1000 |
| JLCLP-1 | Polyolefin | White | 0.61 (15.5) | 0.33 (8.4) | 0.61 (15.5) | 0.41 (10.4) | 12 | 23 | 276 | 4 | 1000 |
| JL3C-10 | Vinyl Cloth | White | 0.75 (19.1) | 0.50 (12.7) | 0.89 (22.7) | 0.58 (14.6) | 9 | 17 | 153 | 66 | 10,000 |
| JL3Y-10 | Polyester | White | 0.75 (19.1) | 0.50 (12.7) | 0.89 (22.7) | 0.58 (14.6) | 9 | 17 | 153 | 66 | 10,000 |
| JL10C-5 | Vinyl Cloth | White | 0.75 (19.1) | 1.00 (25.4) | 0.89 (22.7) | 1.07 (27.2) | 9 | 9 | 81 | 62 | 5000 |
| JL10P-5 | Destructible Paper | White | 0.75 (19.1) | 1.00 (25.4) | 0.89 (22.7) | 1.07 (27.2) | 9 | 9 | 81 | 62 | 5000 |
| JL10Y-5 | Polyester | White | 0.75 (19.1) | 1.00 (25.4) | 0.89 (22.7) | 1.07 (27.2) | 9 | 9 | 81 | 62 | 5000 |
| JL901C-5 | Vinyl Cloth | White | 0.75 (19.1) | 1.25 (31.8) | 0.89 (22.7) | 1.38 (35.1) | 9 | 7 | 63 | 80 | 5000 |
| JL901PO-5 | Polyolefin | White | 0.75 (19.1) | 1.25 (31.8) | 0.89 (22.7) | 1.38 (35.1) | 9 | 7 | 63 | 80 | 5000 |
| JL901Y-5 | Polyester | White | 0.75 (19.1) | 1.25 (31.8) | 0.89 (22.7) | 1.38 (35.1) | 9 | 7 | 63 | 80 | 5000 |

Labels are supplied on 8.50" x 11.00" (215.9 x 279.4 mm) sheets.
*Order number of labels required in multiples of Std. Pkg. Qty.

Blank Ink Jet Labels by Size (cont.)

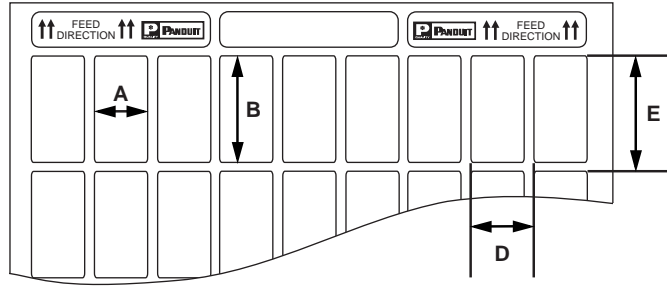

| Part Number | Material | Color | Label Width A In. (mm) | Label Length B In. (mm) | Horizontal Repeat D In. (mm) | Vertical Repeat E In. (mm) | No. of Col. | No. of Rows | Labels Per Sheet | Sheets Per Pkg. | Std. Pkg. Qty.* |
|-------------|--------------------|-------|------------------------|-------------------------|------------------------------|----------------------------|-------------|-------------|------------------|-----------------|-----------------|
| JL35C-2.5 | Vinyl Cloth | White | 0.75 (19.1) | 1.50 (38.1) | 0.89 (22.7) | 1.63 (41.3) | 9 | 6 | 54 | 47 | 2500 |
| JL35P-2.5 | Destructible Paper | White | 0.75 (19.1) | 1.50 (38.1) | 0.89 (22.7) | 1.63 (41.3) | 9 | 6 | 54 | 47 | 2500 |
| JL35PO-2.5 | Polyolefin | White | 0.75 (19.1) | 1.50 (38.1) | 0.89 (22.7) | 1.63 (41.3) | 9 | 6 | 54 | 47 | 2500 |
| JL35Y-2.5 | Polyester | White | 0.75 (19.1) | 1.50 (38.1) | 0.89 (22.7) | 1.63 (41.3) | 9 | 6 | 54 | 47 | 2500 |
| JL42PO-1 | Polyolefin | White | 0.80 (20.3) | 1.50 (38.1) | 0.89 (22.5) | 1.58 (40.0) | 9 | 6 | 54 | 19 | 1000 |
| JL17P-2.5 | Destructible Paper | White | 0.83 (21.2) | 1.88 (47.6) | 1.01 (25.7) | 1.95 (49.4) | 8 | 5 | 40 | 63 | 2500 |
| JL17PO-1 | Polyolefin | White | 0.83 (21.2) | 1.88 (47.6) | 1.01 (25.7) | 1.95 (49.4) | 8 | 5 | 40 | 25 | 1000 |
| JL17PO-2.5 | Polyolefin | White | 0.83 (21.2) | 1.88 (47.6) | 1.01 (25.7) | 1.95 (49.4) | 8 | 5 | 40 | 63 | 2500 |
| JL17Y-2.5 | Polyester | White | 0.83 (21.2) | 1.88 (47.6) | 1.01 (25.7) | 1.95 (49.4) | 8 | 5 | 40 | 63 | 2500 |
| JL902P-2.5 | Destructible Paper | White | 1.00 (25.4) | 1.75 (44.5) | 1.15 (29.2) | 1.88 (47.6) | 7 | 5 | 35 | 72 | 2500 |
| JL902Y-2.5 | Polyester | White | 1.00 (25.4) | 1.75 (44.5) | 1.15 (29.2) | 1.88 (47.6) | 7 | 5 | 35 | 72 | 2500 |
| JL412PO-1 | Polyolefin | White | 1.38 (34.9) | 0.19 (4.8) | 1.63 (41.4) | 0.25 (6.4) | 5 | 38 | 190 | 6 | 1000 |
| JL33C-5 | Vinyl Cloth | White | 1.44 (36.5) | 0.50 (12.7) | 1.62 (41.0) | 0.58 (14.6) | 5 | 17 | 85 | 59 | 5000 |
| JL33PO-2.5 | Polyolefin | White | 1.44 (36.5) | 0.50 (12.7) | 1.62 (41.0) | 0.58 (14.6) | 5 | 17 | 85 | 30 | 2500 |
| JL33Y-5 | Polyester | White | 1.44 (36.5) | 0.50 (12.7) | 1.62 (41.0) | 0.58 (14.6) | 5 | 17 | 85 | 59 | 5000 |
| JL900C-2.5 | Vinyl Cloth | White | 1.44 (36.5) | 0.80 (20.3) | 1.62 (41.0) | 0.87 (22.1) | 5 | 11 | 55 | 46 | 2500 |
| JLEFPS-1 | Polyolefin | White | 1.80 (45.7) | 0.38 (9.5) | 2.01 (51.1) | 0.45 (11.6) | 4 | 21 | 84 | 12 | 1000 |
| JL18PO-1 | Polyolefin | White | 1.88 (47.8) | 1.33 (33.8) | 2.01 (51.1) | 1.58 (40.13) | 4 | 6 | 24 | 42 | 1000 |
| JL41PO-0.5 | Polyolefin | White | 2.00 (50.8) | 0.90 (22.9) | 2.95 (74.9) | 1.05 (26.7) | 3 | 9 | 27 | 19 | 500 |
| JL903P-0.5 | Destructible Paper | White | 2.75 (69.9) | 2.75 (69.9) | 2.75 (69.9) | 3.15 (80.0) | 3 | 3 | 9 | 56 | 500 |
| JL22PO-1 | Polyolefin | White | 7.88 (200.0) | 0.50 (12.7) | — | 0.63 (15.9) | 1 | 15 | 15 | 67 | 1000 |
| JL25P-SH | Paper | White | 8.50 (215.9) | 11.00 (279.4) | — | — | 1 | 1 | 1 | 25 | 25 |
| JL25Y-SH | Polyester | White | 8.50 (215.9) | 11.00 (279.4) | — | — | 1 | 1 | 1 | 25 | 25 |

Labels are supplied on 8.50" x 11.00" (215.9 x 279.4 mm) sheets.
 *Order number of labels required in multiples of Std. Pkg. Qty.

Ink Jet Labels

Laser Printable Labels - Introduction

General Information:

Panduit Laser Labels are designed to function in most desk-top laser printers.

Polyester materials are provided on a clear liner to assure clear movement throughout your printer's paper path. Most Panduit Labels are intended for flat application labeling, with the exception of Self-Laminating Polyester Labels (GMY3) and Permanent Polyolefin Labels (GMPO).

All labels can also be used in a wide variety of copiers. If you need to make many of the same label, a copier might be the quickest solution. Note: Some copiers do reduce the legend slightly so we suggest you print your legend on paper and then test transferring it to your laser label sheet with your copier.

Sheet Formats:

Panduit Laser Labels are provided in two sheet formats:

- PLL labels are provided on U.S. Letter Sheets which are 8.5" x 11.0" (215.9 mm x 279.4 mm).
- PEL labels are provided on DIN A4 Sheets which are 8.27" x 11.69" (210 mm x 297 mm).

Test Labels on Your Printer:

The rapid advances in laser printing technology make it increasingly difficult to test all laser materials on the ever increasing number of individual printer models.

The suitability of a specific material in a particular printer and for a particular application depends greatly on the printer model and operating conditions. We recommend that each user test the suggested material on their printer and in each unique application.

To order sample sheets of a specific label call your local Panduit distributor or sales office.

Choose from three types of Panduit Laser Printable Labels for excellent print quality using your own printer:



Self-Laminating Laser Printable Labels

- Panduit Blank Self-Laminating Laser Labels provide excellent print quality and clear, crisp legends. These labels are available in a thin polyester film for indoor/outdoor applications. Print on the white print-on area, then protect the legend using the clear over-laminate.



Blank Laser Printable Labels

- Panduit Blank Laser Labels are available in specific sizes for different flat labeling applications.



Litho Paper Laser Printable Labels

- These labels are made from standard litho paper and are available in common sizes. These labels can be used for a wide variety of general labeling applications.

Suggested Applications for Laser Labels



Wire and Cable Labeling

Recommended Materials

| Material | Color | Usage | Part Number Listing on Page |
|-----------------|---------------|------------------|-----------------------------|
| GMPO Polyolefin | White | Indoor | 61 |
| GMY3 Polyester | White / Clear | Indoor / Outdoor | 60-61 |



Flat Ribbon Cable Labeling

Recommended Materials

| Material | Color | Usage | Part Number Listing on Page |
|-----------------|---------------|------------------|-----------------------------|
| GMPO Polyolefin | White | Indoor | 61 |
| GMY3 Polyester | White / Clear | Indoor / Outdoor | 60-61 |



Electronic Labeling

Recommended Materials

| Material | Color | Usage | Part Number Listing on Page |
|-----------------------------------|--------|------------------|-----------------------------|
| GMPO Polyolefin | White | Indoor | 61 |
| GMPOR Removable Polyolefin | White | Indoor | 61 |
| GMY3-C Polyester | Clear | Indoor / Outdoor | 62 |
| GMY2-W Polyester | White | Indoor / Outdoor | 63-64 |
| GMY2-Y Polyester | Yellow | Indoor / Outdoor | 64-65 |
| GMY2-S Polyester | Silver | Indoor / Outdoor | 65 |
| GMY2-STE Tamper Evident Polyester | Silver | Indoor / Outdoor | 66 |



Name and Rating Plates

Recommended Materials

| Material | Color | Usage | Part Number Listing on Page |
|-----------------------------------|--------|------------------|-----------------------------|
| GMPO Polyolefin | White | Indoor | 61 |
| GMY3-C Polyester | Clear | Indoor / Outdoor | 62 |
| GMY2-W Polyester | White | Indoor / Outdoor | 63-64 |
| GMY2-Y Polyester | Yellow | Indoor / Outdoor | 64-65 |
| GMY2-S Polyester | Silver | Indoor / Outdoor | 65 |
| GMY2-STE Tamper Evident Polyester | Silver | Indoor / Outdoor | 66 |

Suggested Applications for Laser Labels (cont.)



Network Systems Labeling

Recommended Materials

| Material | Color | Usage | Part Number Listing on Page |
|------------------|-------|------------------|-----------------------------|
| GMPO Polyolefin | White | Indoor | 67-69 |
| GMY3-C Polyester | Clear | Indoor / Outdoor | 67-69 |
| GMY2-W Polyester | White | Indoor / Outdoor | 67-69 |



Asset Labeling

Recommended Materials

| Material | Color | Usage | Part Number Listing on Page |
|------------------|--------|------------------|-----------------------------|
| GMY3-C Polyester | Clear | Indoor / Outdoor | 62 |
| GMY2-W Polyester | White | Indoor / Outdoor | 63-64 |
| GMY2-Y Polyester | Yellow | Indoor / Outdoor | 64-65 |



Bar Code Labeling

Recommended Materials

| Material | Color | Usage | Part Number Listing on Page |
|------------------|-------|------------------|-----------------------------|
| GMPO Polyolefin | White | Indoor | 61 |
| GMY2-W Polyester | White | Indoor / Outdoor | 63-64 |



General Labeling

Recommended Materials

| Material | Color | Usage | Part Number Listing on Page |
|-------------|-------|--------|-----------------------------|
| Litho Paper | White | Indoor | 62 |

Laser Label Material Selection Guide

Choose the material that best suits your application:

| Material Code | Material Type | Temperature Range | Key Features | Color | Outdoor Rated | Hazardous Environment | UL Rec. | CSA |
|---------------|--------------------------|---------------------------------|--|-------------|---------------|-----------------------|---------|-----|
| — | Litho Paper | -65°F to 200°F (-54°C to 93°C) | Standard litho paper for general indoor labeling | White | No | No | No | No |
| GMPO | Polyolefin | -50°F to 120°F (-46°C to 49°C) | For general identification and wire marking; excellent print quality | White | No | No | No | No |
| GMPOR | Removable Polyolefin | -40°F to 200°F (-40°C to 93°C) | Removable adhesive for temporary indoor applications; excellent print quality | White | No | No | No | No |
| GMY3 | Polyester | 0°F to 275°F (-18°C to 135°C) | Used for high quality indoor/outdoor self-laminating labels | Clear | Yes | Yes | No | No |
| GMY3-C | Polyester | 0°F to 275°F (-18°C to 135°C) | Provides durability, high temperature resistance, and dimensional stability; Use on colored or clear surface | Clear | Yes | Yes | No | No |
| GMY3M | Polyester | 0°F to 275°F (-18°C to 135°C) | Provides durability, high temperature resistance, and dimensional stability; Use on colored or clear surface | Matte Clear | Yes | Yes | No | No |
| GMY2-W | Polyester | 0°F to 275°F (-18°C to 135°C) | Provides durability, high temperature resistance, and dimensional stability | White | Yes | Yes | Yes | Yes |
| GMY2-Y | Polyester | 0°F to 275°F (-18°C to 135°C) | Provides durability, high temperature resistance, and dimensional stability | Yellow | Yes | Yes | Yes | Yes |
| GMY2-S | Polyester | 0°F to 275°F (-18°C to 135°C) | Metallized polyester provides opacity, durability, high temperature resistance, and dimensional stability | Silver | Yes | Yes | No | No |
| GMY2-STE | Tamper Evident Polyester | -40°F to 302°F (-40°C to 150°C) | Destructible material; label cannot be completely removed; for tamper evident applications | Silver | Yes | No | No | No |



Self-Laminating Labels

- Print on the white print-on area and over-laminate with clear portion for permanent, clean identification
- Preferred material chosen for most OEM applications
- Thin film with permanent adhesive

Clear Polyester – Indoor/Outdoor Applications

U.S. Letter Sheet Format (8.5" x 11" / 215.9 mm x 279.4 mm)

| Part Number | Material | Print-On Area Color | Label Size Width x Length In. (mm) | Print-On Area Width x Length In. (mm) | Nominal Cable Outside Diameter * In. (mm) | Dwg. Page No. | Std. Pkg. Qty.* |
|----------------|----------------------------------|---------------------|------------------------------------|---------------------------------------|---|-------------------------|-----------------|
| PLL-3-Y3-5 | GMY3-C Self-Laminating Polyester | White | 0.50 x 0.75 (12.7 x 19.1) | 0.50 x 0.34 (12.7 x 8.64) | 0.11 - 0.13 (2.7 - 3.3) | 70 | 5000 |
| PLL-33-Y3-5 | | White | 0.50 x 1.50 (12.7 x 38.1) | 0.50 x 0.50 (12.7 x 12.7) | | 70 | 5000 |
| PLL-10-Y3-2.5 | | White | 1.00 x 0.75 (25.4 x 19.1) | 1.00 x 0.34 (25.4 x 8.64) | | 0.11 - 0.13 (2.7 - 3.3) | 70 |
| PLL-10-Y3-5 | | White | 1.00 x 0.75 (25.4 x 19.1) | 1.00 x 0.34 (25.4 x 8.64) | 70 | | 5000 |
| PLL-11-Y3-2.5† | | White | 1.00 x 1.00 (25.4 x 25.4) | 1.00 x 0.34 (25.4 x 8.64) | 0.11 - 0.21 (2.7 x 5.3) | 70 | 2500 |
| PLL-12-Y3-1 | | White | 1.00 x 1.33 (25.4 x 33.8) | 1.00 x 0.50 (25.4 x 12.7) | | 0.16 - 0.26 (4.0 - 6.7) | 70 |
| PLL-12-Y3-2.5† | | White | 1.00 x 1.33 (25.4 x 33.8) | 1.00 x 0.50 (25.4 x 12.7) | 70 | | 2500 |
| PLL-39-Y3-1 | | White | 1.00 x 1.33 (25.4 x 33.8) | 1.00 x 0.50 (25.4 x 12.7) | 70 | | 1000 |
| PLL-13-Y3-D | | White | 1.00 x 3.17 (25.4 x 80.5) | 1.00 x 0.97 (25.4 x 24.6) | 0.31 - 0.70 (7.8 - 17.8) | 70 | 500 |
| PLL-13-Y3-1 | | White | 1.00 x 3.17 (25.4 x 80.5) | 1.00 x 0.97 (25.4 x 24.6) | | 70 | 1000 |
| PLL-38-Y3-1 | | White | 1.00 x 5.45 (25.4 x 138.4) | 1.00 x 1.00 (25.4 x 25.4) | 0.32 - 1.42 (8.1 - 36.1) | 70 | 1000 |
| PLL-37-Y3-1 | | White | 1.88 x 3.17 (47.6 x 80.5) | 1.88 x 0.97 (47.6 x 24.6) | 0.31 - 0.70 (7.8 - 17.8) | 70 | 1000 |
| PLL-40-Y3-1 | | White | 2.00 x 1.50 (50.8 x 38.1) | 2.00 x 0.50 (50.8 x 12.7) | 0.16 - 0.32 (4.0 - 8.1) | 70 | 1000 |
| PLL-21-Y3-1 | | White | 2.00 x 3.17 (50.8 x 80.5) | 2.00 x 1.00 (50.8 x 25.4) | 0.32 - 0.69 (8.1 - 17.5) | 70 | 1000 |

*Refer to Wire Size Selection Guide on page 196 to review diameters of commonly used cables

†Labels available with TIA Specified Colored Print-On Area; to order, add the following letters after-Y3 in the part number: B for Blue, BR for Brown, G for Green, IG for Gray, OR for Orange, PR for Purple, RD for Red and Y for Yellow. i.e. PLL-11-Y3B-2.5 has a Blue Print-On Area.

Self-Laminating Labels by Material (cont.)

Clear Polyester – Indoor/Outdoor Applications (cont.)

DIN A4 Sheet Format (8.26" x 11.69" / 210 mm x 297 mm)

| Part Number | Material | Print-On Area Color | Label Size Width x Length In. (mm) | Print-On Area Width x Length In. (mm) | Nominal Cable Outside Diameter* In. (mm) | Dwg. Page No. | Std. Pkg. Qty.* |
|----------------|----------------------------------|---------------------|------------------------------------|---------------------------------------|--|---------------|-----------------|
| PEL-17-Y3-2.5† | GMY3-C Self-Laminating Polyester | White | 0.70 x 1.33 (17.8 x 33.9) | 0.70 x 0.33 (17.8 x 8.5) | 0.11 - 0.32 (2.8 - 8.1) | 71 | 2500 |
| PEL-18-Y3-1† | | White | 0.90 x 2.17 (22.9 x 55.0) | 0.90 x 0.50 (22.9 x 12.7) | 0.16 - 0.53 (4.1 - 13.5) | 71 | 1000 |
| PEL-19-Y3-1† | | White | 1.00 x 2.67 (25.4 x 67.7) | 1.00 x 0.67 (25.4 x 16.9) | 0.21 - 0.64 (5.3 - 16.2) | 71 | 1000 |
| PEL-20-Y3-1 | | White | 1.20 x 2.67 (30.5 x 67.7) | 1.20 x 0.83 (30.5 x 21.1) | 0.26 - 0.58 (6.6 - 14.7) | 71 | 1000 |
| PEL-21-Y3-0.5† | | White | 1.40 x 3.67 (35.6 x 93.1) | 1.40 x 1.00 (35.6 x 25.4) | 0.32 - 0.85 (8.1 - 21.6) | 71 | 500 |
| PEL-22-Y3-0.5 | | White | 1.40 x 5.50 (35.6 x 140.0) | 1.40 x 1.00 (35.6 x 25.4) | 0.32 - 1.40 (8.1 - 35.6) | 71 | 500 |
| PEL-23-Y3-0.5 | | White | 1.80 x 5.50 (45.7 x 140.0) | 1.80 x 1.167 (45.7 x 29.6) | 0.37 - 1.38 (9.4 - 35.0) | 71 | 500 |

*Refer to Wire Size Selection Guide on page 196 to review diameters of commonly used cables

†Labels available with TIA Specified Colored Print-On Areas; to order replace -Y3 with -BLU for Blue, -BRN for Brown, -GRN for Green, -GRY for Gray, -ORN for Orange, -PUR for Purple, -RED for Red, and -YEL for Yellow. i.e. PEL-17-BLU-2.5 has a Blue Print-On Area.

Clear Polyolefin – Indoor Applications

DIN A4 Sheet Format (8.26" x 11.69" / 210 mm x 297 mm)

| Part Number | Material | Print-On Area Color | Label Size Width x Length In. (mm) | Print-On Area Width x Length In. (mm) | Nominal Cable Outside Diameter* In. (mm) | Dwg. Page No. | Std. Pkg. Qty.* |
|--------------|-----------------|---------------------|------------------------------------|---------------------------------------|--|---------------|-----------------|
| PEL-18-PO3-1 | GMPO Polyolefin | White | 0.90 x 2.17 (22.9 x 55.0) | 0.90 x 0.50 (22.9 x 12.7) | 0.16 - 0.53 (4.1 - 13.5) | 71 | 1000 |

*Refer to Wire Size Selection Guide on page 196 to review diameters of commonly used cables

Blank Labels by Material



- Non-laminated material used in indoor applications
- Permanent adhesive
- Excellent print quality, limited resistance to solvents and oil

Polyolefin - Indoor Applications

U.S. Letter Sheet Format (8.5" x 11" / 215.9 mm x 279.4 mm)

| Part Number | Material | Color | Label Size Width x Length In. (mm) | Dwg. Page No. | Std. Pkg. Qty.* |
|---------------|-----------------|-------|------------------------------------|---------------|-----------------|
| PLL-33-PO-5 | GMPO Polyolefin | White | 0.50 x 1.50 (12.7 x 38.1) | 72 | 5000 |
| PLL-8-PO-10 | | | 1.00 x 0.38 (25.4 x 9.5) | 72 | 10,000 |
| PLL-10-PO-5 | | | 1.00 x 0.75 (25.4 x 19.1) | 73 | 5000 |
| PLL-14-PO-5 | | | 1.50 x 0.25 (38.1 x 6.4) | 73 | 5000 |
| PLL-35-PO-2.5 | | | 1.50 x 0.75 (38.1 x 19.1) | 73 | 2500 |
| PLL-16-PO-2.5 | | | 1.88 x 0.38 (47.6 x 9.5) | 73 | 2500 |
| PLL-17-PO-2.5 | | | 1.88 x 0.83 (47.6 x 21.1) | 74 | 2500 |
| PLL-36-PO-1 | | | 2.50 x 1.00 (63.5 x 25.4) | 74 | 1000 |
| PLL-22-PO-1† | | | 7.88 x 0.50 (200.0 x 12.7) | 74 | 1000 |
| PLL-25-PO-SH | | | 8.50 x 11.00 (215.9 x 279.4) | 74 | 25 |

†Labels available in colors; to order add the following suffix to part number: -Y for Yellow, -R for Red, -B for Blue, -G for Green, -GR for Gray, -PR for Purple and -BR for Brown



- Used for temporary identification

Removable Polyolefin - Indoor Applications

U.S. Letter Sheet Format (8.5" x 11" / 215.9 mm x 279.4 mm)

| Part Number | Material | Color | Label Size Width x Length In. (mm) | Dwg. Page No. | Std. Pkg. Qty.* |
|----------------|----------------------------|-------|------------------------------------|---------------|-----------------|
| PLL-31-POR-10 | GMPOR Removable Polyolefin | White | 0.50 x 0.44 (12.7 x 11.1) | 72 | 10,000 |
| PLL-9-POR-10 | | | 1.00 x 0.50 (25.4 x 12.7) | 73 | 10,000 |
| PLL-34-POR-10 | | | 1.25 x 0.38 (31.8 x 9.5) | 73 | 10,000 |
| PLL-14-POR-5 | | | 1.50 x 0.25 (38.1 x 6.4) | 73 | 5000 |
| PLL-35-POR-2.5 | | | 1.50 x 0.75 (38.1 x 19.1) | 73 | 2500 |
| PLL-36-POR-1 | | | 2.50 x 1.00 (63.5 x 25.4) | 74 | 1000 |
| PLL-19-POR-2.5 | | | 3.00 x 0.38 (76.2 x 9.5) | 74 | 2500 |
| PLL-25-POR-SH | | | 8.50 x 11.00 (215.9 x 279.4) | 74 | 25 |

*Order number of labels required in multiples of Std. Pkg. Qty.

Blank Labels by Material (cont.)



- Used for shipping or labeling
- Excellent black/white contrast for bar code applications
- Most economical labeling solution

Litho Paper - Indoor/Temporary Applications

U.S. Letter Sheet Format (8.5" x 11" / 215.9 mm x 279.4 mm)

| Part Number | Material | Color | Label Size Width x Length In. (mm) | Dwg. Page No. | Sheets Per Pkg. | Std. Pkg. Qty.* |
|--------------|-------------|-------|------------------------------------|---------------|-----------------|-----------------|
| LL2561-100G | Litho Paper | White | 2.83 x 1.00 (72.0 x 25.4) | 75 | 100 | 1 Pkg. |
| LL2561-100 | | | 2.83 x 1.00 (72.0 x 25.4) | 75 | 100 | 1 Pkg. |
| LL2561-250 | | | 2.83 x 1.00 (72.0 x 25.4) | 75 | 250 | 1 Pkg. |
| LL2561-500 | | | 2.83 x 1.00 (72.0 x 25.4) | 75 | 500 | 1 Pkg. |
| LL256138-100 | | | 2.83 x 1.38 (72.0 x 34.9) | 75 | 100 | 1 Pkg. |
| LL25615-100G | | | 2.83 x 1.50 (72.0 x 38.1) | 75 | 100 | 1 Pkg. |
| LL4252-100G | | | 4.25 x 2.00 (108.0 x 50.8) | 75 | 100 | 1 Pkg. |
| LL425275-250 | | | 4.25 x 2.00 (108.0 x 50.8) | 75 | 250 | 1 Pkg. |
| LL42513-100G | | | 4.25 x 13.00 (108.0 x 330.2) | 75 | 100 | 1 Pkg. |
| LL8511-100 | | | 8.50 x 11.00 (215.9 x 279.4) | 75 | 100 | 1 Pkg. |

*Order number of packages required in multiples of Std. Pkg. Qty.

- Use on colored or clear surfaces
- Durable polyester material is UV and temperature resistant
- Apply to flat, clean surfaces only

Clear Polyester - Indoor/Outdoor Applications

U.S. Letter Sheet Format (8.5" x 11" / 215.9 mm x 279.4 mm)

| Part Number | Material | Color | Label Size Width x Length In. (mm) | Dwg. Page No. | Std. Pkg. Qty.* |
|----------------|----------------|-------|------------------------------------|---------------|-----------------|
| PLL-24-Y3-1 | GMY3 Polyester | Clear | 0.56 x 0.19 (14.3 x 4.8) | 72 | 1000 |
| PLL-24-Y3-5 | | | 0.56 x 0.19 (14.3 x 4.8) | 72 | 5000 |
| PLL-23-Y3-1 | | | 0.56 x 0.56 (14.3 x 14.3) | 72 | 1000 |
| PLL-23-Y3-5 | | | 0.56 x 0.56 (14.3 x 14.3) | 72 | 5000 |
| PLL-9-Y3C-5 | | | 1.00 x 0.50 (25.4 x 12.7) | 73 | 5000 |
| PLL-10-Y3C-2.5 | | | 1.00 x 0.75 (25.4 x 19.1) | 73 | 2500 |
| PLL-11-Y3C-2.5 | | | 1.00 x 1.00 (25.4 x 25.4) | 73 | 2500 |
| PLL-22-Y3-1 | | | 7.88 x 0.50 (200.0 x 12.7) | 74 | 1000 |
| PLL-25-Y3C-SH | | | 8.50 x 11.00 (215.9 x 279.4) | 74 | 25 |

*Order number of labels required in multiples of Std. Pkg. Qty.

DIN A4 Sheet Format (8.26" x 11.69" / 210 mm x 297 mm)

| Part Number | Material | Color | Label Size Width x Length In. (mm) | Dwg. Page No. | Std. Pkg. Qty.* |
|--------------|----------------|-------|------------------------------------|---------------|-----------------|
| PEL-A4-Y3-25 | GMY3 Polyester | Clear | 8.27 x 11.69 (210.0 x 297.0) | 77 | 25 |

*Order number of labels required in multiples of Std. Pkg. Qty.

- Matte clear finish
- Use on colored or clear surfaces
- Durable polyester material is UV and temperature resistant
- Apply to flat, clean surfaces only

Matte Clear Polyester - Indoor/Outdoor Applications

DIN A4 Sheet Format (8.26" x 11.69" / 210 mm x 297 mm)

| Part Number | Material | Color | Label Size Width x Length In. (mm) | Dwg. Page No. | Std. Pkg. Qty.* |
|---------------|-----------------|-------------|------------------------------------|---------------|-----------------|
| PEL-29-Y3M-10 | GMY3M Polyester | Matte Clear | 0.56 x 0.25 (14.3 x 6.4) | 76 | 10,000 |
| PEL-28-Y3M-5 | | | 0.56 x 0.56 (14.3 x 14.3) | 76 | 5000 |
| PEL-10-Y3M-5 | | | 0.70 x 0.50 (17.8 x 12.7) | 76 | 5000 |
| PEL-2-Y3M-10 | | | 1.00 x 0.25 (25.4 x 6.4) | 76 | 10,000 |
| PEL-7-Y3M-5 | | | 1.50 x 0.33 (38.1 x 8.5) | 77 | 5000 |
| PEL-A4-Y3M-25 | | | 8.27 x 11.69 (210.0 x 297.0) | 77 | 25 |

*Order number of labels required in multiples of Std. Pkg. Qty.

Blank Labels by Material (cont.)



- Adhesive becomes permanent after 24 hours
- Durable polyester, ideal for the top of circuit boards
- Can be used (on top) before wave solder process
- UV resistant for outdoor applications
- Apply to flat, clean surfaces only

White Polyester - Indoor/Outdoor Applications

U.S. Letter Sheet Format (8.5" x 11" / 215.9 mm x 279.4 mm)

| Part Number | Material | Color | Label Size Width x Length In. (mm) | Dwg. Page No. | Std. Pkg. Qty.* |
|---------------|------------------------------|-------|--|---------------------|-----------------------|
| PLL-30-Y2-10 | GMY2-W Polyester | White | 0.25 x 0.25 (6.4 x 6.4) | 75 | 10,000 |
| PLL-1-Y2-10 | | | 0.30 x 0.25 (7.6 x 6.4) | 75 | 10,000 |
| PLL-2-Y2-10 | | | 0.38 x 0.38 (9.5 x 9.5) | 72 | 10,000 |
| PLL-31-Y2-10 | | | 0.50 x 0.44 (12.7 x 11.1) | 72 | 10,000 |
| PLL-24-Y2-1 | | | 0.56 x 0.19 (14.3 x 4.8) | 72 | 1000 |
| PLL-24-Y2-5 | | | 0.56 x 0.19 (14.3 x 4.8) | 72 | 5000 |
| PLL-23-Y2-1 | | | 0.56 x 0.56 (14.3 x 14.3) | 72 | 1000 |
| PLL-23-Y2-5 | | | 0.56 x 0.56 (14.3 x 14.3) | 72 | 5000 |
| PLL-32-Y2-10 | | | 0.65 x 0.20 (16.5 x 5.1) | 72 | 10,000 |
| PLL-4-Y2-10 | | | 0.65 x 0.25 (16.5 x 6.4) | 72 | 10,000 |
| PLL-20-Y2-10 | | | 0.80 x 0.20 (20.3 x 5.1) | 72 | 10,000 |
| PLL-5-Y2-10 | | | 0.80 x 0.25 (20.3 x 6.4) | 72 | 10,000 |
| PLL-6-Y2-5 | | | 0.80 x 0.50 (20.3 x 12.7) | 72 | 5000 |
| PLL-6-Y2-10 | | | 0.80 x 0.50 (20.3 x 12.7) | 72 | 10,000 |
| PLL-7-Y2-10 | | | 1.00 x 0.25 (25.4 x 6.4) | 72 | 10,000 |
| PLL-8-Y2-5 | | | 1.00 x 0.38 (25.4 x 9.5) | 72 | 5000 |
| PLL-8-Y2-10 | | | 1.00 x 0.38 (25.4 x 9.5) | 72 | 10,000 |
| PLL-9-Y2-5 | | | 1.00 x 0.50 (25.4 x 12.7) | 73 | 5000 |
| PLL-9-Y2-10 | | | 1.00 x 0.50 (25.4 x 12.7) | 72 | 10,000 |
| PLL-10-Y2-2.5 | | | 1.00 x 0.75 (25.4 x 19.1) | 73 | 2500 |
| PLL-11-Y2-2.5 | | | 1.00 x 1.00 (25.4 x 25.4) | 73 | 2500 |
| PLL-12-Y2-1 | | | 1.00 x 1.33 (25.4 x 33.8) | 73 | 1000 |
| PLL-12-Y2-2.5 | | | 1.00 x 1.33 (25.4 x 33.8) | 73 | 2500 |
| PLL-34-Y2-10 | | | 1.25 x 0.38 (31.8 x 9.5) | 73 | 10,000 |
| PLL-14-Y2-5 | | | 1.50 x 0.25 (38.1 x 6.4) | 73 | 5000 |
| PLL-14-Y2-10 | | | 1.50 x 0.25 (38.1 x 6.4) | 73 | 10,000 |
| PLL-15-Y2-5 | | | 1.88 x 0.25 (47.6 x 6.4) | 73 | 5000 |
| PLL-15-Y2-10 | | | 1.88 x 0.25 (47.6 x 6.4) | 73 | 10,000 |
| PLL-16-Y2-2.5 | | | 1.88 x 0.38 (47.6 x 9.5) | 73 | 2500 |
| PLL-16-Y2-5 | | | 1.88 x 0.38 (47.6 x 9.5) | 73 | 5000 |
| PLL-17-Y2-1 | | | 1.88 x 0.83 (47.6 x 21.1) | 73 | 1000 |
| PLL-17-Y2-2.5 | | | 1.88 x 0.83 (47.6 x 21.1) | 73 | 2500 |
| PLL-18-Y2-1 | | | 1.88 x 1.33 (47.6 x 33.8) | 74 | 1000 |
| PLL-18-Y2-1.5 | | | 1.88 x 1.33 (47.6 x 33.8) | 74 | 1500 |
| PLL-36-Y2-1 | 2.50 x 1.00 (63.5 x 25.4) | 74 | 1000 | | |
| PLL-26-Y2-1 | 2.83 x 1.00 (72.0 x 25.4) | 74 | 1000 | | |
| PLL-27-Y2-1 | 2.83 x 1.38 (72.0 x 34.9) | 74 | 1000 | | |
| PLL-28-Y2-1 | 2.83 x 1.50 (72.0 x 38.1) | 74 | 1000 | | |
| PLL-19-Y2-1 | 3.00 x 0.38 (76.2 x 9.5) | 74 | 1000 | | |
| PLL-19-Y2-2.5 | 3.00 x 0.38 (76.2 x 9.5) | 74 | 2500 | | |
| PLL-29-Y2-1 | 4.25 x 2.00 (108.0 x 50.8) | 74 | 1000 | | |
| PLL-22-Y2-1 | 7.88 x 0.50 (200.0 x 12.7) | 74 | 1000 | | |
| PLL-25-Y2-SH | 8.50 x 11.00 (215.9 x 279.4) | 74 | 25 | | |

*Order number of labels required in multiples of Std. Pkg. Qty.

Blank Labels by Material (cont.)



- Adhesive becomes permanent after 24 hours
- Durable polyester, ideal for the top of circuit boards
- Can be used (on top) before wave solder process
- UV resistant for outdoor applications
- Apply to flat, clean surfaces only

White Polyester - Indoor/Outdoor Applications (cont.)

DIN A4 Sheet Format (8.26" x 11.69" / 210 mm x 297 mm)

| Part Number | Material | Color | Label Size Width x Length In. (mm) | Dwg. Page No. | Std. Pkg. Qty.* |
|---------------|------------------|-------|------------------------------------|---------------|-----------------|
| PEL-9-Y2-10 | GMY2-W Polyester | White | 0.50 x 0.50 (12.7 x 12.7) | 76 | 10,000 |
| PEL-29-Y2-10 | | | 0.56 x 0.25 (14.3 x 6.4) | 76 | 10,000 |
| PEL-28-Y2-5 | | | 0.56 x 0.56 (14.3 x 14.3) | 76 | 5000 |
| PEL-1-Y2-10 | | | 0.70 x 0.25 (17.8 x 6.4) | 76 | 10,000 |
| PEL-4-Y2-10 | | | 0.70 x 0.33 (17.8 x 8.5) | 76 | 10,000 |
| PEL-10-Y2-5 | | | 0.70 x 0.50 (17.8 x 12.7) | 76 | 5000 |
| PEL-5-Y2-10 | | | 0.80 x 0.33 (20.3 x 8.5) | 76 | 10,000 |
| PEL-2-Y2-10 | | | 1.00 x 0.25 (25.4 x 6.4) | 76 | 10,000 |
| PEL-6-Y2-5 | | | 1.00 x 0.33 (25.4 x 8.5) | 76 | 5000 |
| PEL-11-Y2-5 | | | 1.00 x 0.50 (25.4 x 12.7) | 76 | 5000 |
| PEL-3-Y2-5 | | | 1.44 x 0.25 (36.5 x 6.4) | 77 | 5000 |
| PEL-7-Y2-5 | | | 1.50 x 0.33 (38.1 x 8.5) | 77 | 5000 |
| PEL-12-Y2-2.5 | | | 1.50 x 0.50 (38.1 x 12.7) | 77 | 2500 |
| PEL-8-Y2-2.5 | | | 2.00 x 0.33 (50.8 x 8.5) | 77 | 2500 |
| PEL-13-Y2-2.5 | | | 2.00 x 0.50 (50.8 x 12.7) | 77 | 2500 |
| PEL-14-Y2-1 | | | 2.00 x 0.83 (50.8 x 21.1) | 77 | 1000 |
| PEL-15-Y2-1 | | | 2.00 x 1.00 (50.8 x 25.4) | 77 | 1000 |
| PEL-16-Y2-0.5 | | | 2.50 x 1.33 (63.5 x 33.9) | 77 | 500 |
| PEL-A4-Y2-25 | | | 8.27 x 11.69 (210.0 x 297.0) | 77 | 25 |



- Adhesive becomes permanent after 24 hours
- Durable polyester, ideal for the top of circuit boards
- Can be used (on top) before wave solder process
- UV resistant for outdoor applications
- Apply to flat, clean surfaces only

Yellow Polyester - Indoor/Outdoor Applications

U.S. Letter Sheet Format (8.5" x 11" / 215.9 mm x 279.4 mm)

| Part Number | Material | Color | Label Size Width x Length In. (mm) | Dwg. Page No. | Std. Pkg. Qty.* |
|----------------|------------------|--------|------------------------------------|---------------|-----------------|
| PLL-1-Y2Y-10 | GMY2-Y Polyester | Yellow | 0.30 x 0.25 (7.6 x 6.4) | 75 | 10,000 |
| PLL-2-Y2Y-10 | | | 0.38 x 0.38 (9.5 x 9.5) | 72 | 10,000 |
| PLL-32-Y2Y-10 | | | 0.65 x 0.20 (16.5 x 5.1) | 72 | 10,000 |
| PLL-4-Y2Y-10 | | | 0.65 x 0.25 (16.5 x 6.4) | 72 | 10,000 |
| PLL-20-Y2Y-10 | | | 0.80 x 0.20 (20.3 x 5.1) | 72 | 10,000 |
| PLL-5-Y2Y-10 | | | 0.80 x 0.25 (20.3 x 6.4) | 72 | 10,000 |
| PLL-6-Y2Y-5 | | | 0.80 x 0.50 (20.3 x 12.7) | 72 | 5000 |
| PLL-6-Y2Y-10 | | | 0.80 x 0.50 (20.3 x 12.7) | 72 | 10,000 |
| PLL-7-Y2Y-10 | | | 1.00 x 0.25 (25.4 x 6.4) | 72 | 10,000 |
| PLL-8-Y2Y-5 | | | 1.00 x 0.38 (25.4 x 9.5) | 72 | 5000 |
| PLL-8-Y2Y-10 | | | 1.00 x 0.38 (25.4 x 9.5) | 72 | 10,000 |
| PLL-9-Y2Y-5 | | | 1.00 x 0.50 (25.4 x 12.7) | 73 | 5000 |
| PLL-9-Y2Y-10 | | | 1.00 x 0.50 (25.4 x 12.7) | 73 | 10,000 |
| PLL-34-Y2Y-10 | | | 1.25 x 0.38 (31.8 x 9.5) | 73 | 10,000 |
| PLL-14-Y2Y-5 | | | 1.50 x 0.25 (38.1 x 6.4) | 73 | 5000 |
| PLL-15-Y2Y-5 | | | 1.88 x 0.25 (47.6 x 6.4) | 73 | 5000 |
| PLL-16-Y2Y-2.5 | | | 1.88 x 0.38 (47.6 x 9.5) | 73 | 2500 |
| PLL-16-Y2Y-5 | | | 1.88 x 0.38 (47.6 x 9.5) | 73 | 5000 |
| PLL-17-Y2Y-2.5 | | | 1.88 x 0.83 (47.6 x 21.1) | 73 | 2500 |
| PLL-18-Y2Y-1 | | | 1.88 x 1.33 (47.6 x 33.8) | 74 | 1000 |
| PLL-18-Y2Y-1.5 | | | 1.88 x 1.33 (47.6 x 33.8) | 74 | 1500 |
| PLL-19-Y2Y-1 | | | 3.00 x 0.38 (76.2 x 9.5) | 74 | 1000 |
| PLL-19-Y2Y-2.5 | | | 3.00 x 0.38 (76.2 x 9.5) | 74 | 2500 |
| PLL-25-Y2Y-SH | | | 8.50 x 11.00 (215.9 x 279.4) | 74 | 25 |

Blank Labels by Material (cont.)



- Adhesive becomes permanent after 24 hours
- Durable polyester, ideal for the top of circuit boards
- UV resistant for outdoor applications
- Apply to flat, clean surfaces only

Yellow Polyester - Indoor/Outdoor Applications (cont.)

DIN A4 Sheet Format (8.26" x 11.69" / 210 mm x 297 mm)

| Part Number | Material | Color | Label Size Width x Length In. (mm) | Dwg. Page No. | Std. Pkg. Qty.* |
|----------------|------------------|--------|------------------------------------|---------------|-----------------|
| PEL-25-Y2Y-10 | GMY2-Y Polyester | Yellow | 0.35 x 0.59 (9.0 x 15.0) | 76 | 10,000 |
| PEL-26-Y2Y-5 | | | 0.43 x 0.75 (11.0 x 19.1) | 76 | 5000 |
| PEL-27-Y2Y-5 | | | 0.43 x 1.50 (11.0 x 38.1) | 76 | 5000 |
| PEL-4-Y2Y-10 | | | 0.70 x 0.33 (17.8 x 8.5) | 76 | 10,000 |
| PEL-10-Y2Y-5 | | | 0.70 x 0.50 (17.8 x 12.7) | 76 | 5000 |
| PEL-24-Y2Y-10 | | | 0.79 x 0.31 (20.0 x 8.0) | 76 | 10,000 |
| PEL-5-Y2Y-10 | | | 0.80 x 0.33 (20.3 x 8.5) | 76 | 10,000 |
| PEL-2-Y2Y-10 | | | 1.00 x 0.25 (25.4 x 6.4) | 76 | 10,000 |
| PEL-11-Y2Y-5 | | | 1.00 x 0.50 (25.4 x 12.7) | 76 | 5000 |
| PEL-7-Y2Y-5 | | | 1.50 x 0.33 (38.1 x 8.5) | 77 | 5000 |
| PEL-12-Y2Y-2.5 | | | 1.50 x 0.50 (38.1 x 12.7) | 77 | 2500 |
| PEL-15-Y2Y-1 | | | 2.00 x 1.00 (50.8 x 25.4) | 77 | 1000 |
| PEL-A4-Y2Y-25 | | | 8.27 x 11.69 (210.0 x 297.0) | 77 | 25 |



- Warning sign, reference EIA (Electronic Industries Assoc) Standard RS-471 and MIL Standard 129J

Static Sensitive Label

DIN A4 Sheet Format (8.26" x 11.69" / 210 mm x 297 mm)

| Part Number | Material | Color | Label Size Width x Length In. (mm) | Printable Area Width x Length In. (mm) | Dwg. Page No. | Std. Pkg. Qty.* |
|-------------|------------------|--------|------------------------------------|--|---------------|-----------------|
| PESS-SEL | GMY2-Y Polyester | Yellow | 1.00 x 0.50 (25.4 x 12.7) | 1.00 x 0.25 (25.4 x 6.4) | 76 | 2500 |

Silver Polyester - Indoor/Outdoor Applications

U.S. Letter Sheet Format (8.5" x 11" / 215.9 mm x 279.4 mm)

| Part Number | Material | Color | Label Size Width x Length In. (mm) | Dwg. Page No. | Std. Pkg. Qty.* |
|----------------|------------------|--------|------------------------------------|---------------|-----------------|
| PLL-9-Y2S-10 | GMY2-S Polyester | Silver | 1.00 x 0.50 (25.4 x 12.7) | 73 | 10,000 |
| PLL-35-Y2S-2.5 | | | 1.50 x 0.75 (38.1 x 19.1) | 73 | 2500 |
| PLL-36-Y2S-1 | | | 2.50 x 1.00 (63.5 x 25.4) | 74 | 1000 |
| PLL-25-Y2S-SH | | | 8.50 x 11.00 (215.9 x 279.4) | 74 | 25 |



- UV opaque material used to cover EPROM windows
- Adhesive becomes permanent after 24 hours
- Durable polyester, ideal for the top of circuit boards
- Can be used (on top) before wave solder process
- UV resistant for outdoor applications
- Apply to flat, clean surfaces only

DIN A4 Sheet Format (8.26" x 11.69" / 210 mm x 297 mm)

| Part Number | Material | Color | Label Size Width x Length In. (mm) | Dwg. Page No. | Std. Pkg. Qty.* |
|---------------|------------------|--------|------------------------------------|---------------|-----------------|
| PEL-9-Y1-10 | GMY2-S Polyester | Silver | 0.50 x 0.50 (12.7 x 12.7) | 76 | 10,000 |
| PEL-1-Y1-10 | | | 0.70 x 0.25 (17.8 x 6.4) | 76 | 10,000 |
| PEL-4-Y1-10 | | | 0.70 x 0.33 (17.8 x 8.5) | 76 | 10,000 |
| PEL-10-Y1-5 | | | 0.70 x 0.50 (17.8 x 12.7) | 76 | 5000 |
| PEL-5-Y1-10 | | | 0.80 x 0.33 (20.3 x 8.5) | 76 | 10,000 |
| PEL-2-Y1-10 | | | 1.00 x 0.25 (25.4 x 6.4) | 76 | 10,000 |
| PEL-6-Y1-5 | | | 1.00 x 0.33 (25.4 x 8.5) | 76 | 5000 |
| PEL-11-Y1-5 | | | 1.00 x 0.50 (25.4 x 12.7) | 76 | 5000 |
| PEL-3-Y1-5 | | | 1.44 x 0.25 (36.5 x 6.4) | 77 | 5000 |
| PEL-7-Y1-5 | | | 1.50 x 0.33 (38.1 x 8.5) | 77 | 5000 |
| PEL-12-Y1-2.5 | | | 1.50 x 0.50 (38.1 x 12.7) | 77 | 2500 |
| PEL-8-Y1-2.5 | | | 2.00 x 0.33 (50.8 x 8.5) | 77 | 2500 |
| PEL-13-Y1-2.5 | | | 2.00 x 0.50 (50.8 x 12.7) | 77 | 2500 |
| PEL-14-Y1-1 | | | 2.00 x 0.83 (50.8 x 21.1) | 77 | 1000 |
| PEL-15-Y1-1 | | | 2.00 x 1.00 (50.8 x 25.4) | 77 | 1000 |
| PEL-16-Y1-0.5 | | | 2.50 x 1.33 (63.5 x 33.9) | 77 | 500 |
| PEL-A4-Y1-25 | | | 8.27 x 11.69 (210.0 x 297.0) | 77 | 25 |

*Order number of labels required in multiples of Std. Pkg. Qty.

Blank Labels by Material (cont.)



- For tamper evident applications

Tamper Evident Polyester - Indoor/Outdoor Applications

DIN A4 Sheet Format (8.26" x 11.69" / 210 mm x 297 mm)

| Part Number | Material | Color | Label Size Width x Length In. (mm) | Dwg. Page No. | Std. Pkg. Qty.* |
|----------------|--------------------------------------|--------|------------------------------------|---------------|-----------------|
| PEL-9-Y1C-10 | GMY2-STE Tamper Evident Polyester | Silver | 0.50 x 0.50 (12.7 x 12.7) | 76 | 10,000 |
| PEL-4-Y1C-10 | | | 0.70 x 0.33 (17.8 x 8.5) | 76 | 10,000 |
| PEL-6-Y1C-5 | | | 1.00 x 0.33 (25.4 x 8.5) | 76 | 5000 |
| PEL-11-Y1C-5 | | | 1.00 x 0.50 (25.4 x 12.7) | 76 | 5000 |
| PEL-3-Y1C-5 | | | 1.40 x 0.25 (36.5 x 6.4) | 77 | 5000 |
| PEL-8-Y1C-2.5 | | | 2.00 x 0.33 (50.8 x 8.5) | 77 | 2500 |
| PEL-15-Y1C-1 | | | 2.00 x 1.00 (50.8 x 25.4) | 77 | 1000 |
| PEL-16-Y1C-0.5 | | | 2.50 x 1.33 (63.5 x 33.9) | 77 | 500 |
| PEL-A4-Y1C-25 | | | 8.27 x 11.69 (210.0 x 297.0) | 77 | 25 |



Full Sheets

- Used for a wide variety of applications
- Full size sheets are available in 7 materials suitable for laser printing
- Ideal for prototyping and low volume custom labeling
- Custom large or irregular label sizes

U.S. Letter Sheet Format (8.5" x 11" / 215.9 mm x 279.4 mm)

| Part Number | Material | Color | Label Size Width x Length In. (mm) | Dwg. Page No. | Std. Pkg. Qty.* |
|---------------|-----------------------|--------|------------------------------------|---------------|-----------------|
| PLL-25-PO-SH | GMPO Polyolefin | White | 8.50 x 11.00 (215.9 x 279.4) | 74 | 25 |
| PLL-25-Y2S-SH | GMY2-S Polyester | Silver | 8.50 x 11.00 (215.9 x 279.4) | 74 | 25 |
| PLL-25-Y3C-SH | GMY3-C Polyester | Clear | 8.50 x 11.00 (215.9 x 279.4) | 74 | 25 |
| PLL-25-Y2-SH | GMY2-W Polyester | White | 8.50 x 11.00 (215.9 x 279.4) | 74 | 25 |
| PLL-25-POR-SH | GMPOR Rem. Polyolefin | White | 8.50 x 11.00 (215.9 x 279.4) | 74 | 25 |
| PLL-25-Y2Y-SH | GMY2-Y Polyester | Yellow | 8.50 x 11.00 (215.9 x 279.4) | 74 | 25 |

DIN A4 Sheet Format (8.26" x 11.69" / 210 mm x 297 mm)

| Part Number | Material | Color | Label Size Width x Length In. (mm) | Dwg. Page No. | Std. Pkg. Qty.* |
|---------------|--------------------------------------|-------------|------------------------------------|---------------|-----------------|
| PEL-A4-Y3-25 | GMY3-C Polyester | Clear | 8.27 x 11.69 (210.0 x 297.0) | 77 | 25 |
| PEL-A4-Y3M-25 | GMY3M Polyester | Matte Clear | 8.27 x 11.69 (210.0 x 297.0) | 77 | 25 |
| PEL-A4-Y1-25 | GMY2-S Polyester | Silver | 8.27 x 11.69 (210.0 x 297.0) | 77 | 25 |
| PEL-A4-Y2-25 | GMY2-W Polyester | White | 8.27 x 11.69 (210.0 x 297.0) | 77 | 25 |
| PEL-A4-Y2Y-25 | GMY2-Y Polyester | Yellow | 8.27 x 11.69 (210.0 x 297.0) | 77 | 25 |
| PEL-A4-Y1C-25 | GMY2-STE Tamper Evident Polyester | Silver | 8.27 x 11.69 (210.0 x 297.0) | 77 | 25 |

TIA/EIA-606 Compliant Network Systems Labeling



What is TIA/EIA-606?

TIA/EIA-606 is a standard from the Telecommunications Industry Association which requires labeling and administration of the telecommunication infrastructure in commercial buildings. TIA-606 applies to Cables, Connectors, Hub Facilities, Termination Facilities (Patch Panels), Conduits and Pathways.

Panduit manufactures a broad range of labeling products to help you conform to TIA/EIA-606.

Along with the labels already shown in this section, the following pages feature labels designed specifically for Network Systems Labeling. Many of these labels can be used with Dot-Matrix and Laser Printers.

*For more information on the complete line of **PAN-NET™** Network Cabling System Products, ask for the Communication Products Catalog.*

Termination Hardware Labeling



Adhesive 110 Block Labels

Designed to work in Laser Printers Only

| Part Number | Material | TIA Color | Label Width In. (mm) | Label Length In. (mm) | Vertical Repeat In. (mm) | No. of Col. | No. of Rows | Labels Per Sheet | Std. Pkg. Qty.* |
|---------------|-----------------|-----------|----------------------|-----------------------|--------------------------|-------------|-------------|------------------|-----------------|
| PLL-22-Y3-1 | GMYP3 Polyester | Clear | 7.88 (200.0) | 0.50 (12.7) | 0.50 (12.7) | 1 | 20 | 20 | 1000 |
| PLL-22-P0-1 | GMPO Polyolefin | White | 7.88 (200.0) | 0.50 (12.7) | 0.50 (12.7) | 1 | 20 | 20 | 1000 |
| PLL-22-P0-1B | | Blue | 7.88 (200.0) | 0.50 (12.7) | 0.50 (12.7) | 1 | 20 | 20 | 1000 |
| PLL-22-P0-1BR | | Brown | 7.88 (200.0) | 0.50 (12.7) | 0.50 (12.7) | 1 | 20 | 20 | 1000 |
| PLL-22-P0-1G | | Green | 7.88 (200.0) | 0.50 (12.7) | 0.50 (12.7) | 1 | 20 | 20 | 1000 |
| PLL-22-P0-1GR | | Gray | 7.88 (200.0) | 0.50 (12.7) | 0.50 (12.7) | 1 | 20 | 20 | 1000 |
| PLL-22-P0-1OR | | Orange | 7.88 (200.0) | 0.50 (12.7) | 0.50 (12.7) | 1 | 20 | 20 | 1000 |
| PLL-22-P0-1PR | | Purple | 7.88 (200.0) | 0.50 (12.7) | 0.50 (12.7) | 1 | 20 | 20 | 1000 |
| PLL-22-P0-1R | | Red | 7.88 (200.0) | 0.50 (12.7) | 0.50 (12.7) | 1 | 20 | 20 | 1000 |
| PLL-22-P0-1Y | | Yellow | 7.88 (200.0) | 0.50 (12.7) | 0.50 (12.7) | 1 | 20 | 20 | 1000 |

Adhesive Labels

- Eliminate the need for standard paper designation strips
- Labels are placed on top of label holders



Non-Adhesive 110 Punch Down Block Labels

Designed to work in Laser and Dot-Matrix Printers

| Part Number | Material | Color | Label Width In. (mm) | Label Length In. (mm) | Vertical Repeat In. (mm) | Labels Per Row | Rows Per Fanfold | Web Width In. (mm) | Std. Pkg. Qty.* |
|-------------|------------------|--------|----------------------|-----------------------|--------------------------|----------------|------------------|--------------------|-----------------|
| DS110 | Semi-Rigid Paper | White | 7.88 (200.0) | 0.50 (12.7) | 0.50 (12.7) | 1 | 15 | 8.50 (215.9) | 150 |
| DS110-BR | | Brown | 7.88 (200.0) | 0.50 (12.7) | 0.50 (12.7) | 1 | 15 | 8.50 (215.9) | 150 |
| DS110-BU | | Blue | 7.88 (200.0) | 0.50 (12.7) | 0.50 (12.7) | 1 | 15 | 8.50 (215.9) | 150 |
| DS110-GR | | Green | 7.88 (200.0) | 0.50 (12.7) | 0.50 (12.7) | 1 | 15 | 8.50 (215.9) | 150 |
| DS110-IG | | Gray | 7.88 (200.0) | 0.50 (12.7) | 0.50 (12.7) | 1 | 15 | 8.50 (215.9) | 150 |
| DS110-OR | | Orange | 7.88 (200.0) | 0.50 (12.7) | 0.50 (12.7) | 1 | 15 | 8.50 (215.9) | 150 |
| DS110-RD | | Red | 7.88 (200.0) | 0.50 (12.7) | 0.50 (12.7) | 1 | 15 | 8.50 (215.9) | 150 |
| DS110-VL | | Violet | 7.88 (200.0) | 0.50 (12.7) | 0.50 (12.7) | 1 | 15 | 8.50 (215.9) | 150 |
| DS110-YL | | Yellow | 7.88 (200.0) | 0.50 (12.7) | 0.50 (12.7) | 1 | 15 | 8.50 (215.9) | 150 |

Non-Adhesive Labels

- To use with Laser Printer, simply tear sheets apart at fanfold perforation and use manual feed supply on printer

*Order number of labels required in multiples of Std. Pkg. Qty.

Network Systems Labeling — Termination Hardware (cont.)



Adhesive Label for Patch Panels and Modular Furniture Faceplates

- Label is perforated on black lines to be used in 2 position, 4 position, or 6 position applications

Designed to work in Laser and Dot-Matrix Printers

| Part Number | Material | Color | Label Width In. (mm) | Label Length In. (mm) | Horizontal Repeat In. (mm) | Vertical Repeat In. (mm) | No. of Col. | No. of Rows | Labels Per Sheet | Std. Pkg. Qty.* |
|-------------|-----------------|--------|----------------------|-----------------------|----------------------------|--------------------------|-------------|-------------|------------------|-----------------|
| CPPLF-5 | GMPO Polyolefin | White | 0.61 (15.5) | 0.33 (8.4) | 0.61 (15.5) | 0.33 (8.4) | 12 | 25 | 300 | 5000 |
| CPPLF-5BU | | Blue | 0.61 (15.5) | 0.33 (8.4) | 0.61 (15.5) | 0.33 (8.4) | 12 | 25 | 300 | 5000 |
| CPPLF-5EI | | Ivory | 0.61 (15.5) | 0.33 (8.4) | 0.61 (15.5) | 0.33 (8.4) | 12 | 25 | 300 | 5000 |
| CPPLF-5GR | | Green | 0.61 (15.5) | 0.33 (8.4) | 0.61 (15.5) | 0.33 (8.4) | 12 | 25 | 300 | 5000 |
| CPPLF-5IG | | Gray | 0.61 (15.5) | 0.33 (8.4) | 0.61 (15.5) | 0.33 (8.4) | 12 | 25 | 300 | 5000 |
| CPPLF-5OR | | Orange | 0.61 (15.5) | 0.33 (8.4) | 0.61 (15.5) | 0.33 (8.4) | 12 | 25 | 300 | 5000 |
| CPPLF-5VL | | Violet | 0.61 (15.5) | 0.33 (8.4) | 0.61 (15.5) | 0.33 (8.4) | 12 | 25 | 300 | 5000 |
| CPPLF-5RD | | Red | 0.61 (15.5) | 0.33 (8.4) | 0.61 (15.5) | 0.33 (8.4) | 12 | 25 | 300 | 5000 |
| CPPLF-5YL | | Yellow | 0.61 (15.5) | 0.33 (8.4) | 0.61 (15.5) | 0.33 (8.4) | 12 | 25 | 300 | 5000 |

Termination Position Labeling



MINI-JACK™ Modular Jack and OPTI-JACK™ Fiber Optic Connector Labels



- Identify individual jacks and connectors
- Wrap around design allows for quick and secure installation
- Labels attach directly to jacks

| Part Number | Material | Color | Label Width In. (mm) | Label Length In. (mm) | Horizontal Repeat In. (mm) | Vertical Repeat In. (mm) | No. of Col. | No. of Rows | Labels Per Sheet | Std. Pkg. Qty.* |
|--------------|-----------------|-------|----------------------|-----------------------|----------------------------|--------------------------|-------------|-------------|------------------|-----------------|
| PLL-46-Y3C-1 | GMYP3 Polyester | Clear | 1.38 (34.9) | 0.19 (4.8) | 1.53 (38.9) | 0.19 (4.8) | 5 | 53 | 265 | 1000 |
| PLL-46-Y2-1 | GMYP2 Polyester | White | 1.38 (34.9) | 0.19 (4.8) | 1.53 (38.9) | 0.19 (4.8) | 5 | 53 | 265 | 1000 |



Surface Mount Box Labels

U.S. Letter Sheet Format (8.5" x 11" / 215.9 mm x 279.4 mm)

| Part Number | Material | Color | Label Size Width x Length In. (mm) | Dwg. Page No. | Std. Pkg. Qty.* |
|-------------|------------------|-------|------------------------------------|---------------|-----------------|
| PLL-23-Y3-1 | GMYP-C Polyester | Clear | 0.56 x 0.56 (14.3 x 14.3) | 72 | 1000 |
| PLL-23-Y3-5 | | Clear | | 72 | 5000 |
| PLL-23-Y2-1 | GMYP-W Polyester | White | 0.56 x 0.56 (14.3 x 14.3) | 72 | 1000 |
| PLL-23-Y2-5 | | White | | 72 | 5000 |

Network Systems Labeling — Termination Position Labeling (cont.)



Faceplates Labels



- For use with **MINI-COM**® Executive and Designer Series Faceplates
- Adhesive label designed to fit on vinyl insert provided with faceplate
- Single and Double Gang versions available
- Can also be used to identify **MINI-COM** Surface Mount Boxes

Adhesive Faceplate Labels

Designed to work in Laser and Ink Jet Printers

| Part Number | Faceplate Type | Material | Color | Label Width In. (mm) | Label Length In. (mm) | Horizontal Repeat In. (mm) | Vertical Repeat In. (mm) | No. of Col. | No. of Rows | Labels Per Sheet | Std. Pkg. Qty.* |
|-------------|----------------|--------------------|-------|----------------------|-----------------------|----------------------------|--------------------------|-------------|-------------|------------------|-----------------|
| JLEFPS-1 | Single Gang | GMPO5-W Polyolefin | White | 1.80 (45.7) | 0.38 (9.5) | 2.01(51.1) | 0.45 (11.6) | 4 | 21 | 84 | 1000 |
| JLEFPD-1 | Double Gang | | White | 0.30 (7.6) | 2.90 (73.7) | 0.38 (9.5) | 3.30 (83.8) | 21 | 3 | 63 | 1000 |

Non-Adhesive Faceplate Labels

Designed to work in Laser and Dot-Matrix Printers

| Part Number | Faceplate Type | Material | Color | Label Width In. (mm) | Label Length In. (mm) | Horizontal Repeat In. (mm) | Vertical Repeat In. (mm) | No. of Col. | No. of Rows | Labels Per Sheet | Std. Pkg. Qty.* |
|-------------|----------------|------------------|-------|----------------------|-----------------------|----------------------------|--------------------------|-------------|-------------|------------------|-----------------|
| EFPT-1 | Single Gang | Semi-Rigid Paper | White | 1.80 (45.7) | 0.38 (9.5) | 1.80 (45.7) | 0.38 (9.5) | 4 | 19 | 76 | 1000 |
| EFPT10-1 | Double Gang | | White | 2.90 (73.7) | 0.30 (7.6) | 2.90 (73.7) | 0.30 (7.6) | 2 | 24 | 48 | 1000 |

For more information on the complete line of **PAN-NET**™ Network Cabling System Products, ask for the Communication Products Catalog.

Self-Laminating Labels by Size



**U.S. Letter Sheet Format
(8.5" x 11" / 215.9 mm x 279.4 mm)**

| Part Number | Material | Print-On Area Color | Label Width A In. (mm) | Label Length B In. (mm) | Print-On Area Length C In. (mm) | Horizontal Repeat D In. (mm) | Vertical Repeat E In. (mm) | No. of Col. | No. of Rows | Labels Per Sheet | Sheets Per Pkg. | Std. Pkg. Qty.* |
|-----------------|-----------|---------------------|---------------------------|----------------------------|------------------------------------|---------------------------------|-------------------------------|-------------|-------------|------------------|-----------------|-----------------|
| PLL-3-Y3-5 | Polyester | White | 0.50 (12.7) | 0.75 (19.1) | 0.34 (8.64) | 0.60 (15.2) | 0.75 (19.1) | 13 | 12 | 156 | 33 | 5000 |
| PLL-33-Y3-5 | Polyester | White | 0.50 (12.7) | 1.50 (38.1) | 0.50 (12.7) | 0.60 (15.2) | 1.50 (38.1) | 13 | 6 | 78 | 65 | 5000 |
| PLL-10-Y3-2.5 | Polyester | White | 1.00 (25.4) | 0.75 (19.1) | 0.34 (8.64) | 1.10 (27.9) | 0.75 (19.1) | 7 | 12 | 84 | 30 | 2500 |
| PLL-10-Y3-5 | Polyester | White | 1.00 (25.4) | 0.75 (19.1) | 0.34 (8.64) | 1.10 (27.9) | 0.75 (19.1) | 7 | 12 | 84 | 60 | 5000 |
| PLL-11-Y3-2.5 | Polyester | White | 1.00 (25.4) | 1.00 (25.4) | 0.34 (8.64) | 1.10 (27.9) | 1.00 (25.4) | 7 | 10 | 70 | 36 | 2500 |
| PLL-11-Y3B-2.5 | Polyester | TIA Blue | 1.00 (25.4) | 1.00 (25.4) | 0.34 (8.64) | 1.10 (27.9) | 1.00 (25.4) | 7 | 10 | 70 | 36 | 2500 |
| PLL-11-Y3BR-2.5 | Polyester | TIA Brown | 1.00 (25.4) | 1.00 (25.4) | 0.34 (8.64) | 1.10 (27.9) | 1.00 (25.4) | 7 | 10 | 70 | 36 | 2500 |
| PLL-11-Y3G-2.5 | Polyester | TIA Green | 1.00 (25.4) | 1.00 (25.4) | 0.34 (8.64) | 1.10 (27.9) | 1.00 (25.4) | 7 | 10 | 70 | 36 | 2500 |
| PLL-11-Y3IG-2.5 | Polyester | TIA Gray | 1.00 (25.4) | 1.00 (25.4) | 0.34 (8.64) | 1.10 (27.9) | 1.00 (25.4) | 7 | 10 | 70 | 36 | 2500 |
| PLL-11-Y3OR-2.5 | Polyester | TIA Orange | 1.00 (25.4) | 1.00 (25.4) | 0.34 (8.64) | 1.10 (27.9) | 1.00 (25.4) | 7 | 10 | 70 | 36 | 2500 |
| PLL-11-Y3PR-2.5 | Polyester | TIA Purple | 1.00 (25.4) | 1.00 (25.4) | 0.34 (8.64) | 1.10 (27.9) | 1.00 (25.4) | 7 | 10 | 70 | 36 | 2500 |
| PLL-11-Y3RD-2.5 | Polyester | TIA Red | 1.00 (25.4) | 1.00 (25.4) | 0.34 (8.64) | 1.10 (27.9) | 1.00 (25.4) | 7 | 10 | 70 | 36 | 2500 |
| PLL-11-Y3Y-2.5 | Polyester | TIA Yellow | 1.00 (25.4) | 1.00 (25.4) | 0.34 (8.64) | 1.10 (27.9) | 1.00 (25.4) | 7 | 10 | 70 | 36 | 2500 |
| PLL-12-Y3-1 | Polyester | White | 1.00 (25.4) | 1.33 (33.8) | 0.47 (11.9) | 1.10 (27.9) | 1.33 (33.8) | 7 | 7 | 49 | 21 | 1000 |
| PLL-12-Y3-2.5 | Polyester | White | 1.00 (25.4) | 1.33 (33.8) | 0.47 (11.9) | 1.10 (27.9) | 1.33 (33.8) | 7 | 7 | 49 | 52 | 2500 |
| PLL-12-Y3B-2.5 | Polyester | TIA Blue | 1.00 (25.4) | 1.33 (33.8) | 0.47 (11.9) | 1.10 (27.9) | 1.33 (33.8) | 7 | 7 | 49 | 52 | 2500 |
| PLL-12-Y3BR-2.5 | Polyester | TIA Brown | 1.00 (25.4) | 1.33 (33.8) | 0.47 (11.9) | 1.10 (27.9) | 1.33 (33.8) | 7 | 7 | 49 | 52 | 2500 |
| PLL-12-Y3G-2.5 | Polyester | TIA Green | 1.00 (25.4) | 1.33 (33.8) | 0.47 (11.9) | 1.10 (27.9) | 1.33 (33.8) | 7 | 7 | 49 | 52 | 2500 |
| PLL-12-Y3IG-2.5 | Polyester | TIA Gray | 1.00 (25.4) | 1.33 (33.8) | 0.47 (11.9) | 1.10 (27.9) | 1.33 (33.8) | 7 | 7 | 49 | 52 | 2500 |
| PLL-12-Y3OR-2.5 | Polyester | TIA Orange | 1.00 (25.4) | 1.33 (33.8) | 0.47 (11.9) | 1.10 (27.9) | 1.33 (33.8) | 7 | 7 | 49 | 52 | 2500 |
| PLL-12-Y3PR-2.5 | Polyester | TIA Purple | 1.00 (25.4) | 1.33 (33.8) | 0.47 (11.9) | 1.10 (27.9) | 1.33 (33.8) | 7 | 7 | 49 | 52 | 2500 |
| PLL-12-Y3RD-2.5 | Polyester | TIA Red | 1.00 (25.4) | 1.33 (33.8) | 0.47 (11.9) | 1.10 (27.9) | 1.33 (33.8) | 7 | 7 | 49 | 52 | 2500 |
| PLL-12-Y3Y-2.5 | Polyester | TIA Yellow | 1.00 (25.4) | 1.33 (33.8) | 0.47 (11.9) | 1.10 (27.9) | 1.33 (33.8) | 7 | 7 | 49 | 52 | 2500 |
| PLL-39-Y3-1 | Polyester | White | 1.00 (25.4) | 1.33 (33.8) | 0.47 (11.9) | 1.10 (27.9) | 1.33 (33.8) | 8 | 8 | 64 | 16 | 1000 |
| PLL-13-Y3-D | Polyester | White | 1.00 (25.4) | 3.17 (80.5) | 0.97 (24.6) | 1.10 (27.9) | 3.17 (80.5) | 7 | 3 | 21 | 24 | 500 |
| PLL-13-Y3-1 | Polyester | White | 1.00 (25.4) | 3.17 (80.5) | 0.97 (24.6) | 1.10 (27.9) | 3.17 (80.5) | 7 | 3 | 21 | 48 | 1000 |
| PLL-38-Y3-1 | Polyester | White | 1.00 (25.4) | 5.45 (138.4) | 1.00 (25.4) | 1.10 (27.9) | 5.45 (138.4) | 7 | 2 | 14 | 72 | 1000 |
| PLL-37-Y3-1 | Polyester | White | 1.88 (47.6) | 3.17 (80.5) | 0.97 (24.6) | 2.00 (50.8) | 3.17 (80.5) | 4 | 3 | 12 | 84 | 1000 |
| PLL-40-Y3-1 | Polyester | White | 2.00 (50.8) | 1.50 (38.1) | 0.50 (12.7) | 2.00 (50.8) | 1.50 (38.1) | 4 | 6 | 24 | 42 | 1000 |
| PLL-21-Y3-1 | Polyester | White | 2.00 (50.8) | 3.17 (80.5) | 1.00 (25.4) | 2.50 (63.5) | 3.17 (80.5) | 3 | 3 | 9 | 111 | 1000 |

Self-Laminating Labels by Size (cont.)



**DIN A4 Sheet Format
(8.26" x 11.69" / 210 mm x 297 mm)**

| Part Number | Material | Print-On Area Color | Label Width A In. (mm) | Label Length B In. (mm) | Print-On Area Length C In. (mm) | Horizontal Repeat D In. (mm) | Vertical Repeat E In. (mm) | No. of Col. | No. of Rows | Labels Per Sheet | Sheets Per Pkg. | Std. Pkg. Qty.* |
|----------------|------------|---------------------|---------------------------|----------------------------|------------------------------------|---------------------------------|-------------------------------|-------------|-------------|------------------|-----------------|-----------------|
| PEL-17-Y3-2.5 | Polyester | White | 0.70 (17.8) | 1.33 (33.8) | 0.33 (8.5) | 0.70 (17.8) | 1.33 (33.8) | 10 | 8 | 80 | 32 | 2500 |
| PEL-17-BLU-2.5 | Polyester | TIA Blue | 0.70 (17.8) | 1.33 (33.8) | 0.33 (8.5) | 0.70 (17.8) | 1.33 (33.8) | 10 | 8 | 80 | 32 | 2500 |
| PEL-17-BRN-2.5 | Polyester | TIA Brown | 0.70 (17.8) | 1.33 (33.8) | 0.33 (8.5) | 0.70 (17.8) | 1.33 (33.8) | 10 | 8 | 80 | 32 | 2500 |
| PEL-17-GRN-2.5 | Polyester | TIA Green | 0.70 (17.8) | 1.33 (33.8) | 0.33 (8.5) | 0.70 (17.8) | 1.33 (33.8) | 10 | 8 | 80 | 32 | 2500 |
| PEL-17-GRY-2.5 | Polyester | TIA Gray | 0.70 (17.8) | 1.33 (33.8) | 0.33 (8.5) | 0.70 (17.8) | 1.33 (33.8) | 10 | 8 | 80 | 32 | 2500 |
| PEL-17-ORN-2.5 | Polyester | TIA Orange | 0.70 (17.8) | 1.33 (33.8) | 0.33 (8.5) | 0.70 (17.8) | 1.33 (33.8) | 10 | 8 | 80 | 32 | 2500 |
| PEL-17-PUR-2.5 | Polyester | TIA Purple | 0.70 (17.8) | 1.33 (33.8) | 0.33 (8.5) | 0.70 (17.8) | 1.33 (33.8) | 10 | 8 | 80 | 32 | 2500 |
| PEL-17-RED-2.5 | Polyester | TIA Red | 0.70 (17.8) | 1.33 (33.8) | 0.33 (8.5) | 0.70 (17.8) | 1.33 (33.8) | 10 | 8 | 80 | 32 | 2500 |
| PEL-17-YEL-2.5 | Polyester | TIA Yellow | 0.70 (17.8) | 1.33 (33.8) | 0.33 (8.5) | 0.70 (17.8) | 1.33 (33.8) | 10 | 8 | 80 | 32 | 2500 |
| PEL-18-PO3-1 | Polyolefin | White | 0.90 (22.9) | 2.17 (55.0) | 0.50 (12.7) | 0.90 (22.9) | 2.17 (55.0) | 8 | 5 | 40 | 25 | 1000 |
| PEL-18-Y3-1 | Polyester | White | 0.90 (22.9) | 2.17 (55.0) | 0.50 (12.7) | 0.90 (22.9) | 2.17 (55.0) | 8 | 5 | 40 | 25 | 1000 |
| PEL-18-BLU-1 | Polyester | TIA Blue | 0.90 (22.9) | 2.17 (55.0) | 0.50 (12.7) | 0.90 (22.9) | 2.17 (55.0) | 8 | 5 | 40 | 25 | 1000 |
| PEL-18-BRN-1 | Polyester | TIA Brown | 0.90 (22.9) | 2.17 (55.0) | 0.50 (12.7) | 0.90 (22.9) | 2.17 (55.0) | 8 | 5 | 40 | 25 | 1000 |
| PEL-18-GRN-1 | Polyester | TIA Green | 0.90 (22.9) | 2.17 (55.0) | 0.50 (12.7) | 0.90 (22.9) | 2.17 (55.0) | 8 | 5 | 40 | 25 | 1000 |
| PEL-18-GRY-1 | Polyester | TIA Gray | 0.90 (22.9) | 2.17 (55.0) | 0.50 (12.7) | 0.90 (22.9) | 2.17 (55.0) | 8 | 5 | 40 | 25 | 1000 |
| PEL-18-ORN-1 | Polyester | TIA Orange | 0.90 (22.9) | 2.17 (55.0) | 0.50 (12.7) | 0.90 (22.9) | 2.17 (55.0) | 8 | 5 | 40 | 25 | 1000 |
| PEL-18-PUR-1 | Polyester | TIA Purple | 0.90 (22.9) | 2.17 (55.0) | 0.50 (12.7) | 0.90 (22.9) | 2.17 (55.0) | 8 | 5 | 40 | 25 | 1000 |
| PEL-18-RED-1 | Polyester | TIA Red | 0.90 (22.9) | 2.17 (55.0) | 0.50 (12.7) | 0.90 (22.9) | 2.17 (55.0) | 8 | 5 | 40 | 25 | 1000 |
| PEL-18-YEL-1 | Polyester | TIA Yellow | 0.90 (22.9) | 2.17 (55.0) | 0.50 (12.7) | 0.90 (22.9) | 2.17 (55.0) | 8 | 5 | 40 | 25 | 1000 |
| PEL-19-Y3-1 | Polyester | White | 1.00 (25.4) | 2.67 (67.7) | 0.67 (16.9) | 1.00 (25.4) | 2.67 (67.7) | 7 | 4 | 28 | 36 | 1000 |
| PEL-19-BLU-1 | Polyester | TIA Blue | 1.00 (25.4) | 2.67 (67.7) | 0.67 (16.9) | 1.00 (25.4) | 2.67 (67.7) | 7 | 4 | 28 | 36 | 1000 |
| PEL-19-BRN-1 | Polyester | TIA Brown | 1.00 (25.4) | 2.67 (67.7) | 0.67 (16.9) | 1.00 (25.4) | 2.67 (67.7) | 7 | 4 | 28 | 36 | 1000 |
| PEL-19-GRN-1 | Polyester | TIA Green | 1.00 (25.4) | 2.67 (67.7) | 0.67 (16.9) | 1.00 (25.4) | 2.67 (67.7) | 7 | 4 | 28 | 36 | 1000 |
| PEL-19-GRY-1 | Polyester | TIA Gray | 1.00 (25.4) | 2.67 (67.7) | 0.67 (16.9) | 1.00 (25.4) | 2.67 (67.7) | 7 | 4 | 28 | 36 | 1000 |
| PEL-19-ORN-1 | Polyester | TIA Orange | 1.00 (25.4) | 2.67 (67.7) | 0.67 (16.9) | 1.00 (25.4) | 2.67 (67.7) | 7 | 4 | 28 | 36 | 1000 |
| PEL-19-PUR-1 | Polyester | TIA Purple | 1.00 (25.4) | 2.67 (67.7) | 0.67 (16.9) | 1.00 (25.4) | 2.67 (67.7) | 7 | 4 | 28 | 36 | 1000 |
| PEL-19-RED-1 | Polyester | TIA Red | 1.00 (25.4) | 2.67 (67.7) | 0.67 (16.9) | 1.00 (25.4) | 2.67 (67.7) | 7 | 4 | 28 | 36 | 1000 |
| PEL-19-YEL-1 | Polyester | TIA Yellow | 1.00 (25.4) | 2.67 (67.7) | 0.67 (16.9) | 1.00 (25.4) | 2.67 (67.7) | 7 | 4 | 28 | 36 | 1000 |
| PEL-20-Y3-1 | Polyester | White | 1.20 (30.5) | 2.67 (67.7) | 0.83 (21.1) | 1.20 (30.5) | 2.67 (67.7) | 6 | 4 | 24 | 42 | 1000 |
| PEL-21-Y3-0.5 | Polyester | White | 1.40 (35.6) | 3.67 (93.1) | 1.00 (25.4) | 1.40 (35.6) | 3.67 (93.1) | 5 | 3 | 15 | 34 | 500 |
| PEL-21-BLU-0.5 | Polyester | TIA Blue | 1.40 (35.6) | 3.67 (93.1) | 1.00 (25.4) | 1.40 (35.6) | 3.67 (93.1) | 5 | 3 | 15 | 34 | 500 |
| PEL-21-BRN-0.5 | Polyester | TIA Brown | 1.40 (35.6) | 3.67 (93.1) | 1.00 (25.4) | 1.40 (35.6) | 3.67 (93.1) | 5 | 3 | 15 | 34 | 500 |
| PEL-21-GRN-0.5 | Polyester | TIA Green | 1.40 (35.6) | 3.67 (93.1) | 1.00 (25.4) | 1.40 (35.6) | 3.67 (93.1) | 5 | 3 | 15 | 34 | 500 |
| PEL-21-GRY-0.5 | Polyester | TIA Gray | 1.40 (35.6) | 3.67 (93.1) | 1.00 (25.4) | 1.40 (35.6) | 3.67 (93.1) | 5 | 3 | 15 | 34 | 500 |
| PEL-21-ORN-0.5 | Polyester | TIA Orange | 1.40 (35.6) | 3.67 (93.1) | 1.00 (25.4) | 1.40 (35.6) | 3.67 (93.1) | 5 | 3 | 15 | 34 | 500 |
| PEL-21-PUR-0.5 | Polyester | TIA Purple | 1.40 (35.6) | 3.67 (93.1) | 1.00 (25.4) | 1.40 (35.6) | 3.67 (93.1) | 5 | 3 | 15 | 34 | 500 |
| PEL-21-RED-0.5 | Polyester | TIA Red | 1.40 (35.6) | 3.67 (93.1) | 1.00 (25.4) | 1.40 (35.6) | 3.67 (93.1) | 5 | 3 | 15 | 34 | 500 |
| PEL-21-YEL-0.5 | Polyester | TIA Yellow | 1.40 (35.6) | 3.67 (93.1) | 1.00 (25.4) | 1.40 (35.6) | 3.67 (93.1) | 5 | 3 | 15 | 34 | 500 |
| PEL-22-Y3-0.5 | Polyester | White | 1.40 (35.6) | 5.50 (140.0) | 1.00 (25.4) | 1.40 (35.6) | 5.50 (140.0) | 5 | 2 | 10 | 50 | 500 |
| PEL-23-Y3-0.5 | Polyester | White | 1.80 (45.7) | 5.50 (140.0) | 1.167 (29.6) | 1.80 (45.7) | 5.50 (140.0) | 4 | 2 | 8 | 63 | 500 |

*Order number of labels required in multiples of Std. Pkg. Qty.

Blank Labels by Size



**U.S. Letter Sheet Format
(8.5" x 11" / 215.9 mm x 279.4 mm)**

| Part Number | Material | Color | Label Width A In. (mm) | Label Length B In. (mm) | Horizontal Repeat D In. (mm) | Vertical Repeat E In. (mm) | No. of Col. | No. of Rows | Labels Per Sheet | Sheets Per Pkg | Std. Pkg. Qty* |
|---------------|-------------------|--------|---------------------------|----------------------------|---------------------------------|-------------------------------|-------------|-------------|------------------|----------------|----------------|
| PLL-2-Y2-10 | Polyester | White | 0.38 (9.5) | 0.38 (9.5) | 0.50 (12.7) | 0.38 (9.5) | 16 | 25 | 400 | 25 | 10,000 |
| PLL-2-Y2Y-10 | Polyester | Yellow | 0.38 (9.5) | 0.38 (9.5) | 0.50 (12.7) | 0.38 (9.5) | 16 | 25 | 400 | 25 | 10,000 |
| PLL-31-Y2-10 | Polyester | White | 0.50 (12.7) | 0.44 (11.1) | 0.60 (15.2) | 0.44 (11.1) | 13 | 22 | 286 | 35 | 10,000 |
| PLL-31-POR-10 | Remov. Polyolefin | White | 0.50 (12.7) | 0.44 (11.1) | 0.60 (15.2) | 0.44 (11.1) | 13 | 22 | 286 | 35 | 10,000 |
| PLL-33-PO-5 | Polyolefin | White | 0.50 (12.7) | 1.50 (38.1) | 0.60 (15.2) | 1.50 (38.1) | 13 | 6 | 78 | 65 | 5000 |
| PLL-24-Y2-1 | Polyester | White | 0.56 (14.3) | 0.19 (4.8) | 0.80 (20.3) | 0.40 (10.2) | 10 | 24 | 240 | 5 | 1000 |
| PLL-24-Y2-5 | Polyester | White | 0.56 (14.3) | 0.19 (4.8) | 0.80 (20.3) | 0.40 (10.2) | 10 | 24 | 240 | 21 | 5000 |
| PLL-24-Y3-1 | Polyester | Clear | 0.56 (14.3) | 0.19 (4.8) | 0.80 (20.3) | 0.40 (10.2) | 10 | 24 | 240 | 5 | 1000 |
| PLL-24-Y3-5 | Polyester | Clear | 0.56 (14.3) | 0.19 (4.8) | 0.80 (20.3) | 0.40 (10.2) | 10 | 24 | 240 | 21 | 5000 |
| PLL-23-Y2-1 | Polyester | White | 0.56 (14.3) | 0.56 (14.3) | 0.80 (20.3) | 0.80 (20.3) | 10 | 12 | 120 | 9 | 1000 |
| PLL-23-Y2-5 | Polyester | White | 0.56 (14.3) | 0.56 (14.3) | 0.80 (20.3) | 0.80 (20.3) | 10 | 12 | 120 | 42 | 5000 |
| PLL-23-Y3-1 | Polyester | Clear | 0.56 (14.3) | 0.56 (14.3) | 0.80 (20.3) | 0.80 (20.3) | 10 | 12 | 120 | 9 | 1000 |
| PLL-23-Y3-5 | Polyester | Clear | 0.56 (14.3) | 0.56 (14.3) | 0.80 (20.3) | 0.80 (20.3) | 10 | 12 | 120 | 42 | 5000 |
| PLL-32-Y2-10 | Polyester | White | 0.65 (16.5) | 0.20 (5.1) | 0.80 (20.3) | 0.20 (5.1) | 10 | 48 | 480 | 21 | 10,000 |
| PLL-32-Y2Y-10 | Polyester | Yellow | 0.65 (16.5) | 0.20 (5.1) | 0.80 (20.3) | 0.20 (5.1) | 10 | 48 | 480 | 21 | 10,000 |
| PLL-4-Y2-10 | Polyester | White | 0.65 (16.5) | 0.25 (6.4) | 0.80 (20.3) | 0.25 (6.4) | 10 | 39 | 390 | 26 | 10,000 |
| PLL-4-Y2Y-10 | Polyester | Yellow | 0.65 (16.5) | 0.25 (6.4) | 0.80 (20.3) | 0.25 (6.4) | 10 | 39 | 390 | 26 | 10,000 |
| PLL-20-Y2-10 | Polyester | White | 0.80 (20.3) | 0.20 (5.1) | 1.00 (25.4) | 0.20 (5.1) | 8 | 45 | 360 | 28 | 10,000 |
| PLL-20-Y2Y-10 | Polyester | Yellow | 0.80 (20.3) | 0.20 (5.1) | 1.00 (25.4) | 0.20 (5.1) | 8 | 45 | 360 | 28 | 10,000 |
| PLL-5-Y2-10 | Polyester | White | 0.80 (20.3) | 0.25 (6.4) | 1.00 (25.4) | 0.25 (6.4) | 8 | 39 | 312 | 33 | 10,000 |
| PLL-5-Y2Y-10 | Polyester | Yellow | 0.80 (20.3) | 0.25 (6.4) | 1.00 (25.4) | 0.25 (6.4) | 8 | 39 | 312 | 33 | 10,000 |
| PLL-6-Y2-5 | Polyester | White | 0.80 (20.3) | 0.50 (12.7) | 1.00 (25.4) | 0.50 (12.7) | 8 | 19 | 152 | 33 | 5000 |
| PLL-6-Y2-10 | Polyester | White | 0.80 (20.3) | 0.50 (12.7) | 1.00 (25.4) | 0.50 (12.7) | 8 | 19 | 152 | 66 | 10,000 |
| PLL-6-Y2Y-5 | Polyester | Yellow | 0.80 (20.3) | 0.50 (12.7) | 1.00 (25.4) | 0.50 (12.7) | 8 | 19 | 152 | 66 | 5000 |
| PLL-6-Y2Y-10 | Polyester | Yellow | 0.80 (20.3) | 0.50 (12.7) | 1.00 (25.4) | 0.50 (12.7) | 8 | 19 | 152 | 33 | 10,000 |
| PLL-7-Y2-10 | Polyester | White | 1.00 (25.4) | 0.25 (6.4) | 1.10 (27.9) | 0.25 (6.4) | 7 | 39 | 273 | 37 | 10,000 |
| PLL-7-Y2Y-10 | Polyester | Yellow | 1.00 (25.4) | 0.25 (6.4) | 1.10 (27.9) | 0.25 (6.4) | 7 | 39 | 273 | 37 | 10,000 |
| PLL-8-Y2-5 | Polyester | White | 1.00 (25.4) | 0.38 (9.5) | 1.10 (27.9) | 0.38 (9.5) | 7 | 25 | 175 | 58 | 5000 |
| PLL-8-Y2-10 | Polyester | White | 1.00 (25.4) | 0.38 (9.5) | 1.10 (27.9) | 0.38 (9.5) | 7 | 25 | 175 | 29 | 10,000 |
| PLL-8-Y2Y-5 | Polyester | Yellow | 1.00 (25.4) | 0.38 (9.5) | 1.10 (27.9) | 0.38 (9.5) | 7 | 25 | 175 | 58 | 5000 |
| PLL-8-Y2Y-10 | Polyester | Yellow | 1.00 (25.4) | 0.38 (9.5) | 1.10 (27.9) | 0.38 (9.5) | 7 | 25 | 175 | 29 | 10,000 |
| PLL-8-PO-10 | Polyolefin | White | 1.00 (25.4) | 0.38 (9.5) | 1.10 (27.9) | 0.38 (9.5) | 7 | 25 | 175 | 58 | 10,000 |

Blank Labels by Size (cont.)



**U.S. Letter Sheet Format
(8.5" x 11" / 215.9 mm x 279.4 mm)**

| Part Number | Material | Color | Label Width A In. (mm) | Label Length B In. (mm) | Horizontal Repeat D In. (mm) | Vertical Repeat E In. (mm) | No. of Col. | No. of Rows | Labels Per Sheet | Sheets Per Pkg | Std. Pkg. Qty* |
|----------------|-------------------|--------|---------------------------|----------------------------|---------------------------------|-------------------------------|-------------|-------------|------------------|----------------|----------------|
| PLL-9-Y2-5 | Polyester | White | 1.00 (25.4) | 0.50 (12.7) | 1.10 (27.9) | 0.50 (12.7) | 7 | 19 | 133 | 76 | 5000 |
| PLL-9-Y2-10 | Polyester | White | 1.00 (25.4) | 0.50 (12.7) | 1.10 (27.9) | 0.50 (12.7) | 7 | 19 | 133 | 38 | 10,000 |
| PLL-9-Y2S-10 | Polyester | Silver | 1.00 (25.4) | 0.50 (12.7) | 1.10 (27.9) | 0.50 (12.7) | 7 | 19 | 133 | 76 | 10,000 |
| PLL-9-Y2Y-5 | Polyester | Yellow | 1.00 (25.4) | 0.50 (12.7) | 1.10 (27.9) | 0.50 (12.7) | 7 | 19 | 133 | 76 | 5000 |
| PLL-9-Y2Y-10 | Polyester | Yellow | 1.00 (25.4) | 0.50 (12.7) | 1.10 (27.9) | 0.50 (12.7) | 7 | 19 | 133 | 38 | 10,000 |
| PLL-9-Y3C-5 | Polyester | Clear | 1.00 (25.4) | 0.50 (12.7) | 1.10 (27.9) | 0.50 (12.7) | 7 | 19 | 133 | 38 | 5000 |
| PLL-9-POR-10 | Remov. Polyolefin | White | 1.00 (25.4) | 0.50 (12.7) | 1.10 (27.9) | 0.50 (12.7) | 7 | 19 | 133 | 76 | 10,000 |
| PLL-10-Y2-2.5 | Polyester | White | 1.00 (25.4) | 0.75 (19.1) | 1.10 (27.9) | 0.75 (19.1) | 7 | 12 | 84 | 30 | 2500 |
| PLL-10-Y3C-2.5 | Polyester | Clear | 1.00 (25.4) | 0.75 (19.1) | 1.10 (27.9) | 0.75 (19.1) | 7 | 12 | 84 | 30 | 2500 |
| PLL-10-PO-5 | Polyolefin | White | 1.00 (25.4) | 0.75 (19.1) | 1.10 (27.9) | 0.75 (19.1) | 7 | 12 | 84 | 30 | 5000 |
| PLL-11-Y2-2.5 | Polyester | White | 1.00 (25.4) | 1.00 (25.4) | 1.10 (27.9) | 1.00 (25.4) | 7 | 10 | 70 | 36 | 2500 |
| PLL-11-Y3C-2.5 | Polyester | Clear | 1.00 (25.4) | 1.00 (25.4) | 1.10 (27.9) | 1.00 (25.4) | 7 | 10 | 70 | 36 | 2500 |
| PLL-12-Y2-1 | Polyester | White | 1.00 (25.4) | 1.33 (33.8) | 1.10 (27.9) | 1.33 (33.8) | 7 | 7 | 49 | 21 | 1000 |
| PLL-12-Y2-2.5 | Polyester | White | 1.00 (25.4) | 1.33 (33.8) | 1.10 (27.9) | 1.33 (33.8) | 7 | 7 | 49 | 52 | 2500 |
| PLL-34-Y2-10 | Polyester | White | 1.25 (31.8) | 0.38 (9.5) | 1.10 (27.9) | 0.38 (9.5) | 5 | 25 | 125 | 80 | 10,000 |
| PLL-34-Y2Y-10 | Polyester | Yellow | 1.25 (31.8) | 0.38 (9.5) | 1.60 (40.6) | 0.38 (9.5) | 5 | 25 | 125 | 80 | 10,000 |
| PLL-34-POR-10 | Remov. Polyolefin | White | 1.25 (31.8) | 0.38 (9.5) | 1.60 (40.6) | 0.38 (9.5) | 5 | 25 | 125 | 80 | 10,000 |
| PLL-14-Y2-5 | Polyester | White | 1.50 (38.1) | 0.25 (6.4) | 1.60 (40.6) | 0.25 (6.4) | 5 | 39 | 195 | 52 | 5000 |
| PLL-14-Y2-10 | Polyester | White | 1.50 (38.1) | 0.25 (6.4) | 1.60 (40.6) | 0.25 (6.4) | 5 | 39 | 195 | 26 | 10,000 |
| PLL-14-Y2Y-5 | Polyester | Yellow | 1.50 (38.1) | 0.25 (6.4) | 1.60 (40.6) | 0.25 (6.4) | 5 | 39 | 195 | 26 | 5000 |
| PLL-14-PO-5 | Polyolefin | White | 1.50 (38.1) | 0.25 (6.4) | 1.60 (40.6) | 0.25 (6.4) | 5 | 39 | 195 | 26 | 5000 |
| PLL-14-POR-5 | Remov. Polyolefin | White | 1.50 (38.1) | 0.25 (6.4) | 1.60 (40.6) | 0.25 (6.4) | 5 | 39 | 195 | 26 | 5000 |
| PLL-35-Y2S-2.5 | Polyester | Silver | 1.50 (38.1) | 0.75 (19.1) | 1.60 (40.6) | 0.75 (19.1) | 5 | 12 | 60 | 42 | 2500 |
| PLL-35-PO-2.5 | Polyolefin | White | 1.50 (38.1) | 0.75 (19.1) | 1.60 (40.6) | 0.75 (19.1) | 5 | 12 | 60 | 42 | 2500 |
| PLL-35-POR-2.5 | Remov. Polyolefin | White | 1.50 (38.1) | 0.75 (19.1) | 1.60 (40.6) | 0.75 (19.1) | 5 | 12 | 60 | 42 | 2500 |
| PLL-15-Y2-5 | Polyester | White | 1.88 (47.6) | 0.25 (6.4) | 2.00 (50.8) | 0.25 (6.4) | 4 | 39 | 156 | 65 | 5000 |
| PLL-15-Y2-10 | Polyester | White | 1.88 (47.6) | 0.25 (6.4) | 2.00 (50.8) | 0.25 (6.4) | 4 | 39 | 156 | 33 | 10,000 |
| PLL-15-Y2Y-5 | Polyester | Yellow | 1.88 (47.6) | 0.25 (6.4) | 2.00 (50.8) | 0.25 (6.4) | 4 | 39 | 156 | 33 | 5000 |
| PLL-16-Y2-2.5 | Polyester | White | 1.88 (47.6) | 0.38 (9.5) | 2.00 (50.8) | 0.38 (9.5) | 4 | 25 | 100 | 25 | 2500 |
| PLL-16-Y2-5 | Polyester | White | 1.88 (47.6) | 0.38 (9.5) | 2.00 (50.8) | 0.38 (9.5) | 4 | 25 | 100 | 50 | 5000 |
| PLL-16-Y2Y-2.5 | Polyester | Yellow | 1.88 (47.6) | 0.38 (9.5) | 2.00 (50.8) | 0.38 (9.5) | 4 | 25 | 100 | 25 | 2500 |
| PLL-16-Y2Y-5 | Polyester | Yellow | 1.88 (47.6) | 0.38 (9.5) | 2.00 (50.8) | 0.38 (9.5) | 4 | 25 | 100 | 50 | 5000 |
| PLL-16-PO-2.5 | Polyolefin | White | 1.88 (47.6) | 0.38 (9.5) | 2.00 (50.8) | 0.38 (9.5) | 4 | 25 | 100 | 25 | 2500 |
| PLL-17-Y2-1 | Polyester | White | 1.88 (47.6) | 0.83 (21.1) | 2.00 (50.8) | 0.83 (21.1) | 4 | 11 | 44 | 23 | 1000 |
| PLL-17-Y2-2.5 | Polyester | White | 1.88 (47.6) | 0.83 (21.1) | 2.00 (50.8) | 0.83 (21.1) | 4 | 11 | 44 | 57 | 2500 |
| PLL-17-Y2Y-2.5 | Polyester | Yellow | 1.88 (47.6) | 0.83 (21.1) | 2.00 (50.8) | 0.83 (21.1) | 4 | 11 | 44 | 57 | 2500 |
| PLL-17-PO-2.5 | Polyolefin | White | 1.88 (47.6) | 0.83 (21.1) | 2.00 (50.8) | 0.83 (21.1) | 4 | 11 | 44 | 57 | 2500 |

*Order number of labels required in multiples of Std. Pkg. Qty.

Blank Labels by Size (cont.)



**U.S. Letter Sheet Format
(8.5" x 11" / 215.9 mm x 279.4 mm)**

| Part Number | Material | Color | Label Width A In. (mm) | Label Length B In. (mm) | Horizontal Repeat D In. (mm) | Vertical Repeat E In. (mm) | No. of Col. | No. of Rows | Labels Per Sheet | Sheets Per Pkg | Std. Pkg. Qty* |
|----------------|-------------------|--------|---------------------------|----------------------------|---------------------------------|-------------------------------|-------------|-------------|------------------|----------------|----------------|
| PLL-18-Y2-1 | Polyester | White | 1.88 (47.6) | 1.33 (33.8) | 2.00 (50.8) | 1.33 (33.8) | 4 | 7 | 28 | 36 | 1000 |
| PLL-18-Y2-1.5 | Polyester | White | 1.88 (47.6) | 1.33 (33.8) | 2.00 (50.8) | 1.33 (33.8) | 4 | 7 | 28 | 54 | 1500 |
| PLL-18-Y2Y-1 | Polyester | Yellow | 1.88 (47.6) | 1.33 (33.8) | 2.00 (50.8) | 1.33 (33.8) | 4 | 7 | 28 | 36 | 1000 |
| PLL-18-Y2Y-1.5 | Polyester | Yellow | 1.88 (47.6) | 1.33 (33.8) | 2.00 (50.8) | 1.33 (33.8) | 4 | 7 | 28 | 54 | 1500 |
| PLL-36-Y2-1 | Polyester | White | 2.50 (63.5) | 1.00 (25.4) | 2.60 (66.0) | 1.00 (25.4) | 3 | 9 | 27 | 38 | 1000 |
| PLL-36-Y2S-1 | Polyester | Silver | 2.50 (63.5) | 1.00 (25.4) | 2.60 (66.0) | 1.00 (25.4) | 3 | 9 | 27 | 38 | 1000 |
| PLL-36-PO-1 | Polyolefin | White | 2.50 (63.5) | 1.00 (25.4) | 2.60 (66.0) | 1.00 (25.4) | 3 | 9 | 27 | 38 | 1000 |
| PLL-36-POR-1 | Remov. Polyolefin | White | 2.50 (63.5) | 1.00 (25.4) | 2.60 (66.0) | 1.00 (25.4) | 3 | 9 | 27 | 38 | 1000 |
| PLL-26-Y2-1 | Polyester | White | 2.83 (72.0) | 1.00 (25.4) | 2.83 (72.0) | 1.00 (25.4) | 3 | 11 | 33 | 31 | 1000 |
| PLL-27-Y2-1 | Polyester | White | 2.83 (72.0) | 1.38 (34.9) | 2.83 (72.0) | 1.38 (34.9) | 3 | 8 | 24 | 42 | 1000 |
| PLL-28-Y2-1 | Polyester | White | 2.83 (72.0) | 1.50 (38.1) | 2.83 (72.0) | 1.50 (38.1) | 3 | 7 | 21 | 48 | 1000 |
| PLL-19-Y2-1 | Polyester | White | 3.00 (76.2) | 0.38 (9.5) | 3.20 (81.3) | 0.38 (9.5) | 2 | 25 | 50 | 20 | 1000 |
| PLL-19-Y2-2.5 | Polyester | White | 3.00 (76.2) | 0.38 (9.5) | 3.20 (81.3) | 0.38 (9.5) | 2 | 25 | 50 | 50 | 2500 |
| PLL-19-Y2Y-1 | Polyester | Yellow | 3.00 (76.2) | 0.38 (9.5) | 3.20 (81.3) | 0.38 (9.5) | 2 | 25 | 50 | 20 | 1000 |
| PLL-19-Y2Y-2.5 | Polyester | Yellow | 3.00 (76.2) | 0.38 (9.5) | 3.20 (81.3) | 0.38 (9.5) | 2 | 25 | 50 | 50 | 2500 |
| PLL-19-POR-2.5 | Remov. Polyolefin | White | 3.00 (76.2) | 0.38 (9.5) | 3.20 (81.3) | 0.38 (9.5) | 2 | 25 | 50 | 50 | 2500 |
| PLL-29-Y2-1 | Polyester | White | 4.25 (108.0) | 2.00 (50.8) | 4.25 (108.0) | 2.00 (50.8) | 2 | 5 | 10 | 100 | 1000 |
| PLL-22-Y2-1 | Polyester | White | 7.88 (200.0) | 0.50 (12.7) | — | 0.50 (12.7) | 1 | 20 | 20 | 50 | 1000 |
| PLL-22-Y3-1 | Polyester | Clear | 7.88 (200.0) | 0.50 (12.7) | — | 0.50 (12.7) | 1 | 20 | 20 | 50 | 1000 |
| PLL-22-PO-1 | Polyolefin | White | 7.88 (200.0) | 0.50 (12.7) | — | 0.50 (12.7) | 1 | 20 | 20 | 50 | 1000 |
| PLL-22-PO-1B | Polyolefin | Blue | 7.88 (200.0) | 0.50 (12.7) | — | 0.50 (12.7) | 1 | 20 | 20 | 50 | 1000 |
| PLL-22-PO-1BR | Polyolefin | Brown | 7.88 (200.0) | 0.50 (12.7) | — | 0.50 (12.7) | 1 | 20 | 20 | 50 | 1000 |
| PLL-22-PO-1G | Polyolefin | Green | 7.88 (200.0) | 0.50 (12.7) | — | 0.50 (12.7) | 1 | 20 | 20 | 50 | 1000 |
| PLL-22-PO-1GR | Polyolefin | Gray | 7.88 (200.0) | 0.50 (12.7) | — | 0.50 (12.7) | 1 | 20 | 20 | 50 | 1000 |
| PLL-22-PO-1OR | Polyolefin | Orange | 7.88 (200.0) | 0.50 (12.7) | — | 0.50 (12.7) | 1 | 20 | 20 | 50 | 1000 |
| PLL-22-PO-1PR | Polyolefin | Purple | 7.88 (200.0) | 0.50 (12.7) | — | 0.50 (12.7) | 1 | 20 | 20 | 50 | 1000 |
| PLL-22-PO-1R | Polyolefin | Red | 7.88 (200.0) | 0.50 (12.7) | — | 0.50 (12.7) | 1 | 20 | 20 | 50 | 1000 |
| PLL-22-PO-1Y | Polyolefin | Yellow | 7.88 (200.0) | 0.50 (12.7) | — | 0.50 (12.7) | 1 | 20 | 20 | 50 | 1000 |
| PLL-25-Y2-SH | Polyester | White | 8.50 (215.9) | 11.00 (279.4) | — | — | 1 | 1 | 1 | 25 | 25 |
| PLL-25-Y2S-SH | Polyester | Silver | 8.50 (215.9) | 11.00 (279.4) | — | — | 1 | 1 | 1 | 25 | 25 |
| PLL-25-Y2Y-SH | Polyester | Yellow | 8.50 (215.9) | 11.00 (279.4) | — | — | 1 | 1 | 1 | 25 | 25 |
| PLL-25-Y3C-SH | Polyester | Clear | 8.50 (215.9) | 11.00 (279.4) | — | — | 1 | 1 | 1 | 25 | 25 |
| PLL-25-PO-SH | Polyolefin | White | 8.50 (215.9) | 11.00 (279.4) | — | — | 1 | 1 | 1 | 25 | 25 |
| PLL-25-POR-SH | Remov. Polyolefin | White | 8.50 (215.9) | 11.00 (279.4) | — | — | 1 | 1 | 1 | 25 | 25 |

Blank Labels by Size (cont.)

Multiple Across – Double Butt-Cut



| Part Number | Material | Color | Label Width A In. (mm) | Label Length B In. (mm) | Horizontal Repeat D In. (mm) | Vertical Repeat E In. (mm) | No. of Col. | No. of Rows | Labels Per Sheet | Sheets Per Pkg | Std. Pkg. Qty* |
|--------------|-----------|--------|------------------------|-------------------------|------------------------------|----------------------------|-------------|-------------|------------------|----------------|----------------|
| PLL-30-Y2-10 | Polyester | White | 0.25 (6.4) | 0.25 (6.4) | 0.60 (15.2) | 0.25 (6.4) | 26 | 36 | 936 | 11 | 10,000 |
| PLL-1-Y2-10 | Polyester | White | 0.30 (7.6) | 0.25 (6.4) | 0.70 (17.8) | 0.25 (6.4) | 22 | 38 | 836 | 12 | 10,000 |
| PLL-1-Y2Y-10 | Polyester | Yellow | 0.30 (7.6) | 0.25 (6.4) | 0.70 (17.8) | 0.25 (6.4) | 22 | 38 | 836 | 12 | 10,000 |

*Order number of labels required in multiples of Std. Pkg. Qty.

Blank Paper Labels (LL) - Drawings and Specifications

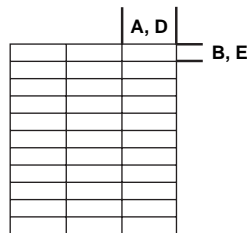

LL2561-100, 250, 500

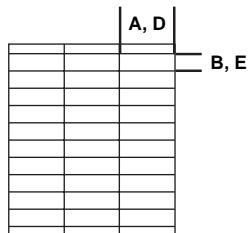

LL2561-100G

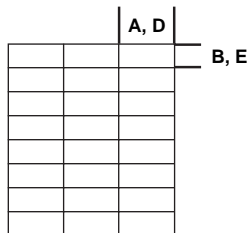

LL2561138-100

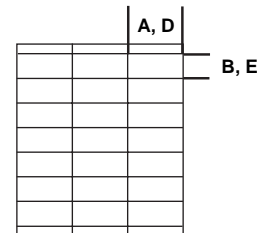

LL25615-100G

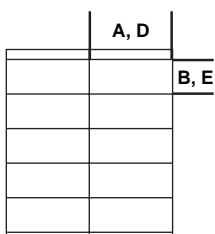

LL4252-100G

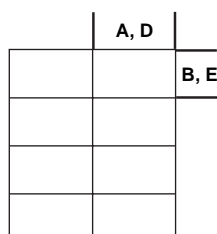

LL42575-250

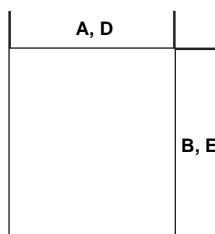

LL8511-100

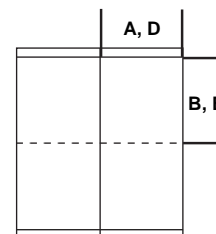

LL42513-100G

| Part Number | Material | Color | Label Width A In. (mm) | Label Length B In. (mm) | Horizontal Repeat D In. (mm) | Vertical Repeat E In. (mm) | No. of Col. | No. of Rows | Labels Per Sheet | Sheets Per Pkg | Labels Per Pkg. | Std. Pkg. Qty* |
|--------------|-------------|-------|------------------------|-------------------------|------------------------------|----------------------------|-------------|-------------|------------------|----------------|-----------------|----------------|
| LL2561-100G | Litho Paper | White | 2.83 (72.0) | 1.00 (25.4) | 2.83 (72.0) | 1.00 (25.4) | 3 | 10 | 30 | 100 | 3000 | 1 Pkg. |
| LL2561-100 | Litho Paper | White | 2.83 (72.0) | 1.00 (25.4) | 2.83 (72.0) | 1.00 (25.4) | 3 | 11 | 33 | 100 | 3300 | 1 Pkg. |
| LL2561-250 | Litho Paper | White | 2.83 (72.0) | 1.00 (25.4) | 2.83 (72.0) | 1.00 (25.4) | 3 | 11 | 33 | 250 | 8250 | 1 Pkg. |
| LL2561-500 | Litho Paper | White | 2.83 (72.0) | 1.00 (25.4) | 2.83 (72.0) | 1.00 (25.4) | 3 | 11 | 33 | 500 | 16,500 | 1 Pkg. |
| LL256138-100 | Litho Paper | White | 2.83 (72.0) | 1.38 (34.9) | 2.83 (72.0) | 1.38 (34.9) | 3 | 8 | 24 | 100 | 2400 | 1 Pkg. |
| LL25615-100G | Litho Paper | White | 2.83 (72.0) | 1.50 (38.1) | 2.83 (72.0) | 1.50 (38.1) | 3 | 7 | 21 | 100 | 2100 | 1 Pkg. |
| LL4252-100G | Litho Paper | White | 4.25 (108.0) | 2.00 (50.8) | 4.25 (108.0) | 2.00 (50.8) | 2 | 5 | 10 | 100 | 1000 | 1 Pkg. |
| LL42575-250 | Litho Paper | White | 4.25 (108.0) | 2.75 (69.9) | 4.25 (108.0) | 2.75 (69.9) | 2 | 4 | 8 | 250 | 2000 | 1 Pkg. |
| LL42513-100G | Litho Paper | White | 4.25 (108.0) | 13.00 (330.2) | 4.25 (108.0) | 13.00 (330.2) | 2 | 2 | 4 | 100 | 400 | 1 Pkg. |
| LL8511-100 | Litho Paper | White | 8.50 (215.9) | 11.00 (279.4) | 8.50 (215.9) | 11.00 (279.4) | 1 | 1 | 1 | 100 | 100 | 1 Pkg. |

*"G" in above part numbers indicates gripper areas (top and bottom margins per sheet), not available for printing.

*Order number of packages required in multiples of Std. Pkg. Qty.

Blank Labels by Size (cont.)



**DIN A4 Sheet Format
(8.26" x 11.69" / 210 mm x 297 mm)**

| Part Number | Material | Color | Label Width A In. (mm) | Label Length B In. (mm) | Horizontal Repeat D In. (mm) | Vertical Repeat E In. (mm) | No. of Col. | No. of Rows | Labels Per Sheet | Sheets Per Pkg | Std. Pkg. Qty* |
|---------------|--------------------------|-------------|------------------------|-------------------------|------------------------------|----------------------------|-------------|-------------|------------------|----------------|----------------|
| PEL-25-Y2Y-10 | Polyester | Yellow | 0.35 (9.0) | 0.59 (15.0) | 0.35 (9.0) | 0.59 (15.0) | 12 | 31 | 372 | 27 | 10,000 |
| PEL-26-Y2Y-5 | Polyester | Yellow | 0.43 (11.0) | 0.75 (19.1) | 0.43 (11.0) | 0.75 (19.1) | 10 | 25 | 250 | 20 | 5000 |
| PEL-27-Y2Y-5 | Polyester | Yellow | 0.43 (11.0) | 1.50 (38.1) | 0.43 (11.0) | 1.50 (38.1) | 5 | 25 | 125 | 40 | 5000 |
| PEL-9-Y1-10 | Polyester | Silver | 0.50 (12.7) | 0.50 (12.7) | 0.50 (12.7) | 0.50 (12.7) | 14 | 22 | 308 | 33 | 10,000 |
| PEL-9-Y2-10 | Polyester | White | 0.50 (12.7) | 0.50 (12.7) | 0.50 (12.7) | 0.50 (12.7) | 14 | 22 | 308 | 33 | 10,000 |
| PEL-9-Y1C-10 | Tamper Evident Polyester | Silver | 0.50 (12.7) | 0.50 (12.7) | 0.50 (12.7) | 0.50 (12.7) | 14 | 22 | 308 | 33 | 10,000 |
| PEL-29-Y2-10 | Polyester | White | 0.56 (14.3) | 0.25 (6.4) | 0.56 (14.3) | 0.25 (6.4) | 13 | 43 | 559 | 18 | 10,000 |
| PEL-29-Y3M-10 | Polyester | Matte Clear | 0.56 (14.3) | 0.25 (6.4) | 0.56 (14.3) | 0.25 (6.4) | 13 | 43 | 559 | 18 | 10,000 |
| PEL-28-Y2-5 | Polyester | White | 0.56 (14.3) | 0.56 (14.3) | 0.56 (14.3) | 0.56 (14.3) | 13 | 19 | 247 | 41 | 5000 |
| PEL-28-Y3M-5 | Polyester | Matte Clear | 0.56 (14.3) | 0.56 (14.3) | 0.56 (14.3) | 0.56 (14.3) | 13 | 19 | 247 | 41 | 5000 |
| PEL-1-Y1-10 | Polyester | Silver | 0.70 (17.8) | 0.25 (6.4) | 0.70 (17.8) | 0.25 (6.4) | 10 | 45 | 450 | 23 | 10,000 |
| PEL-1-Y2-10 | Polyester | White | 0.70 (17.8) | 0.25 (6.4) | 0.70 (17.8) | 0.25 (6.4) | 10 | 45 | 450 | 23 | 10,000 |
| PEL-4-Y1-10 | Polyester | Silver | 0.70 (17.8) | 0.33 (8.5) | 0.70 (17.8) | 0.33 (8.5) | 10 | 33 | 330 | 31 | 10,000 |
| PEL-4-Y2-10 | Polyester | White | 0.70 (17.8) | 0.33 (8.5) | 0.70 (17.8) | 0.33 (8.5) | 10 | 33 | 330 | 31 | 10,000 |
| PEL-4-Y2Y-10 | Polyester | Yellow | 0.70 (17.8) | 0.33 (8.5) | 0.70 (17.8) | 0.33 (8.5) | 10 | 33 | 330 | 31 | 10,000 |
| PEL-4-Y1C-10 | Tamper Evident Polyester | Silver | 0.70 (17.8) | 0.33 (8.5) | 0.70 (17.8) | 0.33 (8.5) | 10 | 33 | 330 | 31 | 10,000 |
| PEL-10-Y1-5 | Polyester | Silver | 0.70 (17.8) | 0.50 (12.7) | 0.70 (17.8) | 0.50 (12.7) | 10 | 22 | 220 | 23 | 5000 |
| PEL-10-Y2-5 | Polyester | White | 0.70 (17.8) | 0.50 (12.7) | 0.70 (17.8) | 0.50 (12.7) | 10 | 22 | 220 | 23 | 5000 |
| PEL-10-Y2Y-5 | Polyester | Yellow | 0.70 (17.8) | 0.50 (12.7) | 0.70 (17.8) | 0.50 (12.7) | 10 | 22 | 220 | 23 | 5000 |
| PEL-10-Y3M-5 | Polyester | Matte Clear | 0.70 (17.8) | 0.50 (12.7) | 0.70 (17.8) | 0.50 (12.7) | 10 | 22 | 220 | 23 | 5000 |
| PEL-24-Y2Y-10 | Polyester | Yellow | 0.79 (20.0) | 0.31 (8.0) | 0.79 (20.2) | 0.31 (8.0) | 9 | 35 | 315 | 32 | 10,000 |
| PEL-5-Y1-10 | Polyester | Silver | 0.80 (20.3) | 0.33 (8.5) | 0.80 (20.3) | 0.33 (8.5) | 9 | 33 | 297 | 34 | 10,000 |
| PEL-5-Y2-10 | Polyester | White | 0.80 (20.3) | 0.33 (8.5) | 0.80 (20.3) | 0.33 (8.5) | 9 | 33 | 297 | 34 | 10,000 |
| PEL-5-Y2Y-10 | Polyester | Yellow | 0.80 (20.3) | 0.33 (8.5) | 0.80 (20.3) | 0.33 (8.5) | 9 | 33 | 297 | 34 | 10,000 |
| PEL-2-Y1-10 | Polyester | Silver | 1.00 (25.4) | 0.25 (6.4) | 1.00 (25.4) | 0.25 (6.4) | 7 | 45 | 315 | 32 | 10,000 |
| PEL-2-Y2-10 | Polyester | White | 1.00 (25.4) | 0.25 (6.4) | 1.00 (25.4) | 0.25 (6.4) | 7 | 45 | 315 | 32 | 10,000 |
| PEL-2-Y2Y-10 | Polyester | Yellow | 1.00 (25.4) | 0.25 (6.4) | 1.00 (25.4) | 0.25 (6.4) | 7 | 45 | 315 | 32 | 10,000 |
| PEL-2-Y3M-10 | Polyester | Matte Clear | 1.00 (25.4) | 0.25 (6.4) | 1.00 (25.4) | 0.25 (6.4) | 7 | 45 | 315 | 32 | 10,000 |
| PEL-6-Y1-5 | Polyester | Silver | 1.00 (25.4) | 0.33 (8.5) | 1.00 (25.4) | 0.33 (8.5) | 7 | 33 | 231 | 22 | 5000 |
| PEL-6-Y2-5 | Polyester | White | 1.00 (25.4) | 0.33 (8.5) | 1.00 (25.4) | 0.33 (8.5) | 7 | 33 | 231 | 22 | 5000 |
| PEL-6-Y1C-5 | Tamper Evident Polyester | Silver | 1.00 (25.4) | 0.33 (8.5) | 1.00 (25.4) | 0.33 (8.5) | 7 | 33 | 231 | 22 | 5000 |
| PEL-11-Y1-5 | Polyester | Silver | 1.00 (25.4) | 0.50 (12.7) | 1.00 (25.4) | 0.50 (12.7) | 7 | 22 | 154 | 33 | 5000 |
| PEL-11-Y2-5 | Polyester | White | 1.00 (25.4) | 0.50 (12.7) | 1.00 (25.4) | 0.50 (12.7) | 7 | 22 | 154 | 33 | 5000 |
| PEL-11-Y2Y-5 | Polyester | Yellow | 1.00 (25.4) | 0.50 (12.7) | 1.00 (25.4) | 0.50 (12.7) | 7 | 22 | 154 | 33 | 5000 |
| PEL-11-Y1C-5 | Tamper Evident Polyester | Silver | 1.00 (25.4) | 0.50 (12.7) | 1.00 (25.4) | 0.50 (12.7) | 7 | 22 | 154 | 33 | 5000 |

Laser Labels

Blank Labels by Size



DIN A4 Sheet Format
(8.26" x 11.69" / 210 mm x 297 mm)

| Part Number | Material | Color | Label Width A In. (mm) | Label Length B In. (mm) | Horizontal Repeat D In. (mm) | Vertical Repeat E In. (mm) | No. of Col. | No. of Rows | Labels Per Sheet | Sheets Per Pkg | Std. Pkg. Qty* |
|--|--------------------------|-------------|---------------------------|----------------------------|---------------------------------|-------------------------------|-------------|-------------|------------------|----------------|----------------|
| PESS-SEL has Static Sensitive Warning printed on top half of label (see drawing below). | | | | | | | | | | | |
| PESS-SEL | Polyester | Yellow | 1.00 (25.4) | 0.50 (12.7) | 1.00 (25.4) | 0.50 (12.7) | 7 | 22 | 154 | 33 | 2500 |
| PEL-3-Y1-5 | Polyester | Silver | 1.44 (36.5) | 0.25 (6.4) | 1.44 (36.5) | 0.25 (6.4) | 5 | 45 | 225 | 23 | 5000 |
| PEL-3-Y2-5 | Polyester | White | 1.44 (36.5) | 0.25 (6.4) | 1.44 (36.5) | 0.25 (6.4) | 5 | 45 | 225 | 23 | 5000 |
| PEL-3-Y1C-5 | Tamper Evident Polyester | Silver | 1.44 (36.5) | 0.25 (6.4) | 1.44 (36.5) | 0.25 (6.4) | 5 | 45 | 225 | 23 | 5000 |
| PEL-7-Y1-5 | Polyester | Silver | 1.50 (38.1) | 0.33 (8.5) | 1.50 (38.1) | 0.33 (8.5) | 5 | 33 | 165 | 31 | 5000 |
| PEL-7-Y2-5 | Polyester | White | 1.50 (38.1) | 0.33 (8.5) | 1.50 (38.1) | 0.33 (8.5) | 5 | 33 | 165 | 31 | 5000 |
| PEL-7-Y2Y-5 | Polyester | Yellow | 1.50 (38.1) | 0.33 (8.5) | 1.50 (38.1) | 0.33 (8.5) | 5 | 33 | 165 | 31 | 5000 |
| PEL-7-Y3M-5 | Polyester | Matte Clear | 1.50 (38.1) | 0.33 (8.5) | 1.50 (38.1) | 0.33 (8.5) | 5 | 33 | 165 | 31 | 5000 |
| PEL-12-Y1-2.5 | Polyester | Silver | 1.50 (38.1) | 0.50 (12.7) | 1.50 (38.1) | 0.50 (12.7) | 5 | 22 | 110 | 23 | 2500 |
| PEL-12-Y2-2.5 | Polyester | White | 1.50 (38.1) | 0.50 (12.7) | 1.50 (38.1) | 0.50 (12.7) | 5 | 22 | 110 | 23 | 2500 |
| PEL-12-Y2Y-2.5 | Polyester | Yellow | 1.50 (38.1) | 0.50 (12.7) | 1.50 (38.1) | 0.50 (12.7) | 5 | 22 | 110 | 23 | 2500 |
| PEL-8-Y1-2.5 | Polyester | Silver | 2.00 (50.8) | 0.33 (8.5) | 2.00 (50.8) | 0.33 (8.5) | 3 | 33 | 99 | 26 | 2500 |
| PEL-8-Y2-2.5 | Polyester | White | 2.00 (50.8) | 0.33 (8.5) | 2.00 (50.8) | 0.33 (8.5) | 3 | 33 | 99 | 26 | 2500 |
| PEL-8-Y1C-2.5 | Tamper Evident Polyester | Silver | 2.00 (50.8) | 0.33 (8.5) | 2.00 (50.8) | 0.33 (8.5) | 3 | 33 | 99 | 26 | 2500 |
| PEL-13-Y1-2.5 | Polyester | Silver | 2.00 (50.8) | 0.50 (12.7) | 2.00 (50.8) | 0.50 (12.7) | 3 | 22 | 66 | 38 | 2500 |
| PEL-13-Y2-2.5 | Polyester | White | 2.00 (50.8) | 0.50 (12.7) | 2.00 (50.8) | 0.50 (12.7) | 3 | 22 | 66 | 38 | 2500 |
| PEL-14-Y1-1 | Polyester | Silver | 2.00 (50.8) | 0.83 (21.1) | 2.00 (50.8) | 0.83 (21.1) | 3 | 13 | 39 | 26 | 1000 |
| PEL-14-Y2-1 | Polyester | White | 2.00 (50.8) | 0.83 (21.1) | 2.00 (50.8) | 0.83 (21.1) | 3 | 13 | 39 | 26 | 1000 |
| PEL-15-Y1-1 | Polyester | Silver | 2.00 (50.8) | 1.00 (25.4) | 2.00 (50.8) | 1.00 (25.4) | 3 | 11 | 33 | 31 | 1000 |
| PEL-15-Y2-1 | Polyester | White | 2.00 (50.8) | 1.00 (25.4) | 2.00 (50.8) | 1.00 (25.4) | 3 | 11 | 33 | 31 | 1000 |
| PEL-15-Y2Y-1 | Polyester | Yellow | 2.00 (50.8) | 1.00 (25.4) | 2.00 (50.8) | 1.00 (25.4) | 3 | 11 | 33 | 31 | 1000 |
| PEL-15-Y1C-1 | Tamper Evident Polyester | Silver | 2.00 (50.8) | 1.00 (25.4) | 2.00 (50.8) | 1.00 (25.4) | 3 | 11 | 33 | 31 | 1000 |
| PEL-16-Y1-0.5 | Polyester | Silver | 2.50 (63.5) | 1.33 (33.8) | 2.50 (63.5) | 1.33 (33.9) | 3 | 8 | 24 | 21 | 500 |
| PEL-16-Y2-0.5 | Polyester | White | 2.50 (63.5) | 1.33 (33.8) | 2.50 (63.5) | 1.33 (33.9) | 3 | 8 | 24 | 21 | 500 |
| PEL-16-Y1C-0.5 | Tamper Evident Polyester | Silver | 2.50 (63.5) | 1.33 (33.8) | 2.50 (63.5) | 1.33 (33.9) | 3 | 8 | 24 | 21 | 500 |
| PEL-A4-Y1-25 | Polyester | Silver | 8.27 (210.0) | 11.69 (297.0) | — | — | 1 | 1 | 1 | 25 | 25 |
| PEL-A4-Y2-25 | Polyester | White | 8.27 (210.0) | 11.69 (297.0) | — | — | 1 | 1 | 1 | 25 | 25 |
| PEL-A4-Y2Y-25 | Polyester | Yellow | 8.27 (210.0) | 11.69 (297.0) | — | — | 1 | 1 | 1 | 25 | 25 |
| PEL-A4-Y3-25 | Polyester | Clear | 8.27 (210.0) | 11.69 (297.0) | — | — | 1 | 1 | 1 | 25 | 25 |
| PEL-A4-Y3M-25 | Polyester | Matte Clear | 8.27 (210.0) | 11.69 (297.0) | — | — | 1 | 1 | 1 | 25 | 25 |
| PEL-A4-Y1C-25 | Tamper Evident Polyester | Silver | 8.27 (210.0) | 11.69 (297.0) | — | — | 1 | 1 | 1 | 25 | 25 |

PESS-SEL

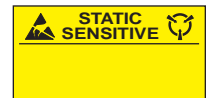

*Order number of labels required in multiples of Std. Pkg. Qty.

Dot-Matrix Labeling Products



Dot-Matrix Labels

Pages 80 to 121

- Available in three types to be used with Panduit PTR1 Dot-Matrix Printer (see **pg. 17**) or other dot-matrix printers
- Easy to align and user friendly
- Mark wires, circuit boards, bins and use for a wide variety of other labeling applications
- Choose from over 120 different sizes and 14 different materials



Dot-Matrix Heat Shrink Labels

Pages 122 to 123

- Heat Shrink Data Label Kits which allow user to create subsurface printed heat shrink markers without the use of special printers
- Full line of heat shrink tools and accessories for use with all Panduit heat shrink markers



Dot-Matrix Data Plates

Pages 124 to 125

- Non-adhesive tags to be used with Panduit PTR1 Dot-Matrix Printer (see **pg. 17**) or other dot-matrix printers
- Mark wires, cables, equipment, inventory and use for a wide variety of other applications where an adhesive label is not suitable
- Fasten Panduit Data Plates with Panduit Intermediate or Standard cross section cable ties



Indelible Ink Ribbons

Pages 126 to 128

- Used to print on non-porous materials to eliminate smearing
- Used on any material to reduce fading caused by exposure to UV rays



Marker Ties and Marker Plates

Pages 129 to 130

- Fasten and identify all types of wire and cable bundles at the same time

Dot-Matrix Labels – Introduction

Panduit Dot-Matrix Labels are used for a wide variety of identification purposes and are available in an extensive choice of materials, styles and sizes.

Features

- Widest selection of materials in the industry that provide weather and chemical resistance and withstand temperature extremes, radiation and UV exposure
- Most extensive choice of sizes and styles
- Compatible with your own computer equipment
- Eliminates the need for large inventories of custom labels

Benefits

- Labels to meet your most critical requirements
- A label is available for every application
- No waiting — produce as many labels as you need exactly when you need them
- Economical, cost effective

Choose from three types of Panduit Dot-Matrix Labels that are easy to align in your printer and easy to use:



Self-Laminating Labels

These labels are mainly used for marking wires and cables. Print on the white print-on area, then wrap the clear over-laminate over the legend to protect your legend.

Panduit Self-Laminating Labels are available in three materials. See [page 84](#) for complete material specifications.



Blank Labels

Panduit Blank Labels are used for a wide variety of applications from marking wires to identifying product through a wave solder process. Labels are produced in specific sizes for different applications.

See [page 84](#) for complete material specifications.



Litho Paper Labels

Used for permanent marking, Litho Paper Labels are made of paper with permanent adhesive. These Labels are available in common sizes and are frequently used for mailing, packaging and other high volume applications.

Suggested Applications for Dot-Matrix Labels



Marking Wires and Cables

Recommended Materials

| Material | Color | Usage | Part Number Listing on Page |
|--|---------------|------------------|-----------------------------|
| GMV3 Self-Laminating Vinyl | White / Clear | Indoor | 85- 86 |
| GMVF Self-Laminating Vinyl Free Polyolefin | White / Clear | Indoor | 86 |
| GMT1 Self-Laminating TEDLAR ^ | White / Clear | Indoor / Outdoor | 87 |
| GMC Vinyl Cloth | White | Indoor | 88-89 |
| GMC-FR Flame Ret. Cloth | White | Indoor | 90 |
| GMP1 Destructible Paper | White | Indoor | 91 |
| GMV Vinyl | White | Indoor | 92 |
| GMT TEDLAR | White | Indoor / Outdoor | 92-93 |



Flat Ribbon Cable Labeling

Recommended Materials

| Material | Color | Usage | Part Number Listing on Page |
|--|---------------|------------------|-----------------------------|
| GMV3 Self-Laminating Vinyl | White / Clear | Indoor | 85- 86 |
| GMVF Self-Laminating Vinyl Free Polyolefin | White / Clear | Indoor | 86 |
| GMT1 Self-Laminating TEDLAR | White / Clear | Indoor / Outdoor | 87 |



Electronic Labeling

Recommended Materials

| Material | Color | Usage | Part Number Listing on Page |
|--------------------------|--------|---------------------------|-----------------------------|
| GMC Vinyl Cloth | White | Indoor | 88-89 |
| GMK Polyimide | Amber | Indoor / High Temperature | 90 |
| GMP Removable Paper | White | Indoor | 91 |
| GMP1 Destructible Paper | White | Indoor | 91 |
| GMV Vinyl | White | Indoor | 92 |
| GMV10 Destructible Vinyl | White | Indoor | 92 |
| GMT TEDLAR | White | Indoor / Outdoor | 92-93 |
| GMV-C Polyester | Clear | Indoor / Outdoor | 94 |
| GMV-W Polyester | White | Indoor / Outdoor | 94-95 |
| GMV-S Polyester | Silver | Indoor / Outdoor | 96 |



Terminal Block Labeling

Recommended Materials

| Material | Color | Usage | Part Number Listing on Page |
|-----------------|-------|------------------|-----------------------------|
| GMC Vinyl Cloth | White | Indoor | 88-89 |
| GMV Vinyl | White | Indoor | 92 |
| GMT TEDLAR | White | Indoor / Outdoor | 92-93 |
| GMV-W Polyester | White | Indoor / Outdoor | 94-95 |

^TEDLAR is the registered trademark of E. I. DuPont Co.

Suggested Applications for Dot-Matrix Labels



Motor Control Labeling — Medium / High Temperature Applications

Recommended Materials

| Material | Color | Usage | Part Number Listing on Page |
|-----------------|--------|------------------|-----------------------------|
| GMV Vinyl | White | Indoor | 92 |
| GMY-C Polyester | Clear | Indoor / Outdoor | 94 |
| GMY-W Polyester | White | Indoor / Outdoor | 94-95 |
| GMY-S Polyester | Silver | Indoor / Outdoor | 96 |



Bar Code Labeling

Recommended Materials

| Material | Color | Usage | Part Number Listing on Page |
|-------------------------|-------|------------------|-----------------------------|
| GMP Removable Paper | White | Indoor | 91 |
| GMP1 Destructible Paper | White | Indoor | 91 |
| GMY-C Polyester | Clear | Indoor / Outdoor | 94 |
| GMY-W Polyester | White | Indoor / Outdoor | 94-95 |



Bin Labels

Recommended Materials

| Material | Color | Usage | Part Number Listing on Page |
|-----------------|------------------|--------|-----------------------------|
| GMC Vinyl Cloth | White and Yellow | Indoor | 88-89 |



Tamper Evident Labeling Applications

Recommended Materials

| Material | Color | Usage | Part Number Listing on Page |
|--------------------------|-------|--------|-----------------------------|
| GMP1 Destructible Paper | White | Indoor | 91 |
| GMV10 Destructible Vinyl | White | Indoor | 92 |

Suggested Applications for Dot-Matrix Labels



Harsh Environment Labeling

Recommended Materials

| Material | Color | Usage | Part Number Listing on Page |
|-----------------|--------|------------------|-----------------------------|
| GMA Aluminum | Silver | Indoor | 90 |
| GMT TEDLAR * | White | Indoor / Outdoor | 92-93 |
| GMV-C Polyester | Clear | Indoor / Outdoor | 94 |
| GMV-W Polyester | White | Indoor / Outdoor | 94-95 |
| GMV-S Polyester | Silver | Indoor / Outdoor | 96 |



Network Systems Labeling

Recommended Materials

| Material | Color | Usage | Part Number Listing on Page |
|----------------------------|---------------|------------------|-----------------------------|
| GMV3 Self-Laminating Vinyl | White / Clear | Indoor | 97 |
| GMT Self-Laminating TEDLAR | White / Clear | Indoor / Outdoor | 97 |
| GMV Vinyl | White | Indoor | 98 - 100 |
| GMPO Polyolefin | White | Indoor | 98 - 100 |
| GMV-C Polyester | Clear | Indoor / Outdoor | 98 - 100 |
| GMV-W Polyester | White | Indoor / Outdoor | 98 - 100 |



Machinery Materials Identification

Recommended Materials

| Material | Color | Usage | Part Number Listing on Page |
|-----------------|------------------|--------|-----------------------------|
| GMC Vinyl Cloth | White and Yellow | Indoor | 101 |



General Labeling

Recommended Materials

| Material | Color | Usage | Part Number Listing on Page |
|-------------|-------|--------|-----------------------------|
| Litho Paper | White | Indoor | 103 - 105 |

*TEDLAR is the registered trademark of E. I. DuPont Co.

Dot-Matrix Label Material Selection Guide

Choose the material that best suits your application:

Self-Laminating Materials

| Material Code | Material Type | Temperature Range | Key Features | Color | Outdoor Rated | Hazardous Environment | UL Rec | CSA |
|---------------|---------------------------------------|-----------------------------------|---|------------------------------|---------------|-----------------------|--------|-----|
| GMV3 | Self-Laminating Vinyl | -40°F to 150°F (-40°C to 66°C) | Preferred material for most general wire and cable labeling; thin, conformable material | Clear w/ White Print-On Area | No | No | Yes | Yes |
| GMVF | Self-Laminating Vinyl Free Polyolefin | -20°F to 140°F (-29°C to 60°C) | Vinyl free material meets CONEG (No heavy metals) and European Market Requirements | Clear w/ White Print-On Area | No | No | No | No |
| GMT1 | Self-Laminating TEDLAR * | 0°F to 275°F (-18°C to 135°C) | Self-extinguishing, outdoor rated material; ideal for wire and cable labeling in harsh environments | Clear w/ White Print-On Area | Yes | Yes | Yes | Yes |

Blank Materials

| Material Code | Material Type | Temperature Range | Key Features | Color | Outdoor Rated | Hazardous Environment | UL Rec | CSA |
|---------------|-----------------------|------------------------------------|--|--------|---------------|-----------------------|--------|-----|
| — | Litho Paper | -65°F to 200°F (-54°C to 93°C) | Highly ink receptive material for economical printing in indoor applications | White | No | No | No | No |
| GMA | Aluminum | -65°F to 300°F (-54°C to 149°C) | Embossed legend ideal for rating plates; resistant to fungus, solvents, and high temperatures | Silver | No | Yes | Yes | Yes |
| GMC | Vinyl Cloth | -50°F to 170°F (-46°C to 77°C) | Repositionable adhesive allows label to be removed and reused or used in temporary applications | White | No | No | No | No |
| GMC-FR | Flame Retardant Cloth | -40°F to 250°F (-40°C to 121°C) | Polymer coated cloth for non-adhesive Rag Tag Labels; Flame retardant material meets U.L. 94-VTMO | White | No | No | No | No |
| GMK | Polyimide | -40°F to 350°F (-40°C to 177°C) | For applications requiring solvent and high temperature resistance, such as the wave solder process | Amber | No | Yes | Yes | No |
| GMP | Removable Paper | 0°F to 120°F (-18°C to 49°C) | Removable adhesive is ideal for temporary marking; labels provide good contrast for bar code scanning | White | No | No | No | No |
| GMP1 | Destructible Paper | -65°F to 200°F (-54°C to 93°C) | Label will destruct upon removal; for permanent and tamper resistant labeling applications | White | No | No | No | No |
| GMPO | Polyolefin | -50°F to 120°F (-46°C to 49°C) | Excellent print quality | White | No | No | No | No |
| GMV | Vinyl | -0°F to 170°F (-18°C to 77°C) | Low cost, conformable material for wire marking applications | White | No | No | Yes | Yes |
| GMV9 | Semi-Rigid Vinyl | -20°F to 176°F (-29°C to 80°C) | Non-adhesive material for high quality tag and marker plate applications | White | No | No | No | No |
| GMV10 | Destructible Vinyl | -65°F to 200°F (-54°C to 93°C) | Destructible material ideal for tamper evident applications; damages most surfaces upon removal of label | White | Yes | No | No | No |
| GMT | TEDLAR | -40°F to 275°F (-40°C to 135°C) | Self-extinguishing film for high quality indoor/outdoor, high temperature labels | White | Yes | Yes | Yes | Yes |
| GMV-C | Polyester | -40°F to 311°F (-40°C to 154°C) | Provides durability, high temperature resistance, and dimensional stability; Use on colored or clear surface | Clear | Yes | Yes | No | No |
| GMV-W | Polyester | -40°F to 311°F (-40°C to 154°C) | Provides durability, high temperature resistance, and dimensional stability | White | Yes | Yes | Yes | Yes |
| GMV-S | Polyester | -40°F to 311°F (-40°C to 154°C) | Metallized polyester provides opacity, durability, high temperature resistance, and dimensional stability | Silver | Yes | Yes | Yes | Yes |

*TEDLAR is the registered trademark of E. I. DuPont Co.

Self-Laminating Labels by Material



GMV3 Self-Laminating Vinyl Labels - Indoor Applications

- Print on the white label area and over-laminate with clear portion for permanent, clean identification
- Preferred material chosen for most OEM and MRO wire marking applications
- Some sizes are available with a colored strip for group identification

| Part Number | Material | Print-On Area Color | Label Size Width x Length In. (mm) | Print-On Area Width x Length In. (mm) | Nominal Cable Outside Diameter * In. (mm) | Dwg. Page No. | Std. Pkg. Qty.* |
|-------------|----------------------------|---------------------|------------------------------------|---------------------------------------|---|--------------------------|-----------------|
| PDL-239 | GMV3 Self-Laminating Vinyl | White | 0.30 x 0.75 (7.6 x 19.1) | 0.30 x 0.38 (7.6 x 9.5) | 0.12 - 0.12 (3.0 - 3.0) | 106 | 5000 |
| PDL-241 | | White | 0.30 x 0.94 (7.6 x 23.8) | 0.30 x 0.38 (7.6 x 9.5) | 0.12 - 0.18 (3.0 - 4.6) | 106 | 5000 |
| PDL-168 | | White | 0.36 x 0.94 (9.1 x 23.8) | 0.36 x 0.38 (9.14 x 9.5) | | 106 | 5000 |
| PDL-117 | | White | 0.50 x 0.75 (12.7 x 19.1) | 0.50 x 0.38 (12.7 x 9.5) | 0.12 - 0.12 (3.0 - 3.0) | 106 | 5000 |
| PDL-42 | | White | 0.50 x 0.75 (12.7 x 19.1) | 0.50 x 0.38 (12.7 x 9.5) | | 106 | 5000 |
| PDL-42-10 | | White | 0.50 x 0.75 (12.7 x 19.1) | 0.50 x 0.38 (12.7 x 9.5) | | 106 | 10,000 |
| PDL-243 | | White | 0.50 x 0.94 (12.7 x 23.8) | 0.50 x 0.38 (12.7 x 9.5) | 0.12 - 0.18 (3.0 - 4.6) | 106 | 5000 |
| PDL-1-1 | | White | 0.50 x 1.44 (12.7 x 36.5) | 0.50 x 0.50 (12.7 x 12.7) | 0.16 - 0.30 (4.0 - 7.6) | 106 | 1000 |
| PDL-1† | | White | 0.50 x 1.44 (12.7 x 36.5) | 0.50 x 0.50 (12.7 x 12.7) | | 106 | 5000 |
| PDL-1-10 | | White | 0.50 x 1.44 (12.7 x 36.5) | 0.50 x 0.50 (12.7 x 12.7) | | 106 | 10,000 |
| PDL-12 | | White | 0.50 x 1.44 (12.7 x 36.5) | 0.50 x 0.50 (12.7 x 12.7) | | 106 | 5000 |
| PDL-6556-2 | | White | 0.60 x 1.44 (15.2 x 36.5) | 0.60 x 0.50 (15.2 x 12.7) | | 106 | 5000 |
| PDL-245-1 | | White | 0.75 x 1.75 (19.1 x 44.5) | 0.75 x 0.50 (19.1 x 12.7) | | 0.16 - 0.40 (4.0 - 10.1) | 107 |
| PDL-245 | | White | 0.75 x 1.75 (19.1 x 44.5) | 0.75 x 0.50 (19.1 x 12.7) | 107 | | 5000 |
| PDL-245-10 | | White | 0.75 x 1.75 (19.1 x 44.5) | 0.75 x 0.50 (19.1 x 12.7) | 107 | | 10,000 |
| PDL-247 | | White | 0.80 x 0.94 (20.3 x 23.8) | 0.80 x 0.38 (20.3 x 9.5) | 0.12 - 0.18 (3.0 - 4.6) | 107 | 5000 |
| PDL-8-1 | | White | 0.80 x 1.44 (20.3 x 36.5) | 0.80 x 0.50 (20.3 x 12.7) | 0.16 - 0.30 (4.0 - 7.6) | 107 | 1000 |
| PDL-8† | | White | 0.80 x 1.44 (20.3 x 36.5) | 0.80 x 0.50 (20.3 x 12.7) | | 107 | 5000 |
| PDL-8-10 | | White | 0.80 x 1.44 (20.3 x 36.5) | 0.80 x 0.50 (20.3 x 12.7) | | 107 | 10,000 |
| PDL-5859-2 | | White | 0.82 x 2.00 (20.8 x 50.8) | 0.82 x 0.63 (20.8 x 15.9) | 0.20 - 0.44 (5.1 - 11.1) | 107 | 5000 |
| PDL-5859-4 | | Yellow | 0.82 x 2.00 (20.8 x 50.8) | 0.82 x 0.63 (20.8 x 15.9) | | 107 | 5000 |
| PDL-249-1 | | White | 1.00 x 0.75 (25.4 x 19.1) | 1.00 x 0.38 (25.4 x 9.5) | 0.12 - 0.12 (3.0 - 3.0) | 107 | 1000 |
| PDL-249 | | White | 1.00 x 0.75 (25.4 x 19.1) | 1.00 x 0.38 (25.4 x 9.5) | | 107 | 5000 |
| PDL-249-10 | | White | 1.00 x 0.75 (25.4 x 19.1) | 1.00 x 0.38 (25.4 x 9.5) | | 107 | 10,000 |
| PDL-251 | | White | 1.00 x 0.94 (25.4 x 23.8) | 1.00 x 0.38 (25.4 x 9.5) | 0.12 - 0.18 (3.0 - 4.6) | 107 | 5000 |
| PDL-2-1 | | White | 1.00 x 1.44 (25.4 x 36.5) | 1.00 x 0.50 (25.4 x 12.7) | 0.16 - 0.30 (4.0 - 7.6) | 108 | 1000 |
| PDL-2† | | White | 1.00 x 1.44 (25.4 x 36.5) | 1.00 x 0.50 (25.4 x 12.7) | | 108 | 5000 |
| PDL-2-10 | | White | 1.00 x 1.44 (25.4 x 36.5) | 1.00 x 0.50 (25.4 x 12.7) | | 108 | 10,000 |
| PDL-9025-10 | | White | 1.00 x 1.44 (25.4 x 36.5) | 1.00 x 0.62 (25.4 x 15.8) | 0.20 - 0.26 (5.0 - 6.6) | 108 | 10,000 |
| PDL-4† | | White | 1.00 x 2.44 (25.4 x 61.9) | 1.00 x 0.75 (25.4 x 19.1) | 0.24 - 0.54 (6.1 - 13.7) | 108 | 1000 |
| PDL-4-10 | | White | 1.00 x 2.44 (25.4 x 61.9) | 1.00 x 0.75 (25.4 x 19.1) | | 108 | 10,000 |
| PDL-6† | | White | 1.00 x 3.94 (25.4 x 100.1) | 1.00 x 1.00 (25.4 x 25.4) | 0.32 - 0.94 (8.1 - 23.8) | 109 | 1000 |
| PDL-6-2.5 | | White | 1.00 x 3.94 (25.4 x 100.1) | 1.00 x 1.00 (25.4 x 25.4) | | 109 | 2500 |
| PDL-6-10 | | White | 1.00 x 3.94 (25.4 x 100.1) | 1.00 x 1.00 (25.4 x 25.4) | | 109 | 10,000 |
| PDL-124 | | White | 1.00 x 5.94 (25.4 x 150.9) | 1.00 x 1.50 (25.4 x 38.1) | 0.48 - 1.41 (12.1 - 35.9) | 109 | 1000 |
| PDL-124-2.5 | | White | 1.00 x 5.94 (25.4 x 150.9) | 1.00 x 1.50 (25.4 x 38.1) | | 109 | 2500 |
| PDL-124-10 | | White | 1.00 x 5.94 (25.4 x 150.9) | 1.00 x 1.50 (25.4 x 38.1) | | 109 | 10,000 |
| PDL-51 | | White | 1.00 x 5.94 (25.4 x 150.9) | 1.00 x 1.50 (25.4 x 38.1) | | 109 | 1000 |
| PDL-126 | | White | 1.00 x 7.44 (25.4 x 189.0) | 1.00 x 1.50 (25.4 x 38.1) | 0.48 - 1.89 (12.1 - 48.0) | 109 | 1000 |
| PDL-126-10 | | White | 1.00 x 7.44 (25.4 x 189.0) | 1.00 x 1.50 (25.4 x 38.1) | | 109 | 10,000 |
| PDL-52 | | White | 1.00 x 7.44 (25.4 x 189.0) | 1.00 x 1.50 (25.4 x 38.1) | | 109 | 1000 |
| PDL-52-2.5 | | White | 1.00 x 7.44 (25.4 x 189.0) | 1.00 x 1.50 (25.4 x 38.1) | | 109 | 2500 |

*Refer to Wire Size Selection Guide on page 196 to review diameters of commonly used cables

†Labels available with colored strip on left hand side of label; to order, add the following letter to part number: B for Blue, BR for Brown, G for Green, GR for Gray, OR for Orange, PR for Purple, R for Red, Y for Yellow.

More sizes shown on the following page

*Order number of labels required in multiples of Std. Pkg. Qty.

Self-Laminating Labels by Material (cont.)

GMV3 Self-Laminating Vinyl Labels - Indoor Applications (cont.)

| Part Number | Material | Print-On Area Color | Label Size Width x Length In. (mm) | Print-On Area Width x Length In. (mm) | Nominal Cable Outside Diameter* In. (mm) | Dwg. Page No. | Std. Pkg. Qty.* |
|-------------|----------------------------|---------------------|------------------------------------|---------------------------------------|--|---------------------------|-----------------|
| PDL-5859-1 | GMV3 Self-Laminating Vinyl | White | 1.13 x 3.75 (28.6 x 95.3) | 1.13 x 1.25 (28.6 x 31.8) | 0.40 - 0.80 (1.1 - 20.2) | 109 | 5000 |
| PDL-5859-3 | | Yellow | 1.13 x 3.75 (28.6 x 95.3) | 1.13 x 1.25 (28.6 x 31.8) | | 109 | 5000 |
| CCS-WHT | | White | 1.17 x 3.00 (29.6 x 76.2) | 1.17 x 0.83 (29.6 x 21.2) | 0.26 - 0.69 (6.6 - 17.5) | 109 | 5000 |
| CCS-YEL | | Yellow | 1.17 x 3.00 (29.6 x 76.2) | 1.17 x 0.83 (29.6 x 21.2) | | 109 | 5000 |
| PDL-6626-10 | | White | 1.20 x 2.25 (30.5 x 57.2) | 1.20 x 0.60 (30.5 x 15.2) | 0.19 - 0.53 (4.9 - 13.3) | 109 | 10,000 |
| PDL-3523-1 | | White | 1.50 x 2.25 (38.1 x 57.2) | 1.50 x 0.50 (38.1 x 12.7) | 0.16 - 0.56 (4.0 - 14.2) | 109 | 1000 |
| PDL-361-1 | | White | 1.50 x 3.63 (38.1 x 92.1) | 1.50 x 0.80 (38.1 x 20.3) | 0.25 - 0.90 (6.5 - 22.9) | 109 | 1000 |
| PDL-109 | | White | 1.90 x 3.19 (48.3 x 81.0) | 1.90 x 0.75 (48.3 x 19.1) | 0.24 - 0.78 (6.1 - 19.7) | 110 | 1000 |
| PDL-109-2.5 | | White | 1.90 x 3.19 (48.3 x 81.0) | 1.90 x 0.75 (48.3 x 19.1) | | 110 | 2500 |
| PDL-18 | | White | 1.90 x 3.19 (48.3 x 81.0) | 1.90 x 0.75 (48.3 x 19.1) | | 110 | 1000 |
| PDL-18-2.5 | | White | 1.90 x 3.19 (48.3 x 81.0) | 1.90 x 0.75 (48.3 x 19.1) | | 110 | 2500 |
| PDL-18-10 | | White | 1.90 x 3.19 (48.3 x 81.0) | 1.90 x 0.75 (48.3 x 19.1) | | 110 | 10,000 |
| PDL-3-1 | | White | 2.00 x 1.44 (50.8 x 36.5) | 2.00 x 0.50 (50.8 x 12.7) | | 0.16 - 0.30 (4.0 - 7.6) | 110 |
| PDL-3† | | White | 2.00 x 1.44 (50.8 x 36.5) | 2.00 x 0.50 (50.8 x 12.7) | 110 | | 5000 |
| PDL-3-10 | | White | 2.00 x 1.44 (50.8 x 36.5) | 2.00 x 0.50 (50.8 x 12.7) | 110 | | 10,000 |
| PDL-5† | | White | 2.00 x 2.44 (50.8 x 61.9) | 2.00 x 0.75 (50.8 x 19.1) | 0.24 - 0.54 (6.1 - 13.7) | 110 | 1000 |
| PDL-5-2.5 | | White | 2.00 x 2.44 (50.8 x 61.9) | 2.00 x 0.75 (50.8 x 19.1) | | 110 | 2500 |
| PDL-5-10 | | White | 2.00 x 2.44 (50.8 x 61.9) | 2.00 x 0.75 (50.8 x 19.1) | | 110 | 10,000 |
| PDL-7†† | | White | 2.00 x 3.94 (50.8 x 100.1) | 2.00 x 1.00 (50.8 x 25.4) | 0.32 - 0.94 (8.1 - 23.8) | 111 | 1000 |
| PDL-7-2.5 | | White | 2.00 x 3.94 (50.8 x 100.1) | 2.00 x 1.00 (50.8 x 25.4) | | 111 | 2500 |
| PDL-7-10 | | White | 2.00 x 3.94 (50.8 x 100.1) | 2.00 x 1.00 (50.8 x 25.4) | | 111 | 10,000 |
| PDL-133 | | White | 2.00 x 5.94 (50.8 x 150.9) | 2.00 x 1.50 (50.8 x 38.1) | 0.48 - 1.41 (12.1 - 35.9) | 111 | 1000 |
| PDL-16 | | White | 2.00 x 5.94 (50.8 x 150.9) | 2.00 x 1.50 (50.8 x 38.1) | | 111 | 1000 |
| PDL-16-2.5 | | White | 2.00 x 5.94 (50.8 x 150.9) | 2.00 x 1.50 (50.8 x 38.1) | | 111 | 2500 |
| PDL-16-10 | | White | 2.00 x 5.94 (50.8 x 150.9) | 2.00 x 1.50 (50.8 x 38.1) | | 111 | 10,000 |
| PDL-115 | | White | 2.00 x 7.44 (50.8 x 189.0) | 2.00 x 1.50 (50.8 x 38.1) | 0.48 - 1.89 (12.1 - 48.0) | 111 | 1000 |
| PDL-115-2.5 | | White | 2.00 x 7.44 (50.8 x 189.0) | 2.00 x 1.50 (50.8 x 38.1) | | 111 | 2500 |
| PDL-17 | | White | 2.00 x 7.44 (50.8 x 189.0) | 2.00 x 1.50 (50.8 x 38.1) | | 111 | 1000 |
| PDL-17-2.5 | | White | 2.00 x 7.44 (50.8 x 189.0) | 2.00 x 1.50 (50.8 x 38.1) | | 111 | 2500 |
| PDL-362-1 | | White | 2.00 x 9.00 (50.8 x 228.6) | 2.00 x 1.50 (50.8 x 38.1) | | 0.48 - 2.39 (12.1 - 60.7) | 111 |

*Refer to Wire Size Selection Guide on page 196 to review diameters of commonly used cables
 †Labels available with colored strip on left hand side of label; to order, add the following letter to part number: B for Blue, BR for Brown, G for Green, GR for Gray, OR for Orange, PR for Purple, R for Red, Y for Yellow.
 ††Labels available with colored strip on left hand side of label; to order, add the following letter to part number: B for Blue, G for Green, R for Red, Y for Yellow.



GMVF Self-Laminating Vinyl Free Polyolefin Labels - Indoor Applications

- Environmentally friendly material
- Material meets European Market Requirements (no heavy metals)

| Part Number | Material | Print-On Area Color | Label Size Width x Length In. (mm) | Print-On Area Width x Length In. (mm) | Nominal Cable Outside Diameter* In. (mm) | Dwg. Page No. | Std. Pkg. Qty.* |
|-------------|---------------------------------|---------------------|------------------------------------|---------------------------------------|--|-------------------------|-----------------|
| PDL-239VF | GMVF Self-Laminating Vinyl Free | White | 0.30 x 0.75 (7.6 x 19.1) | 0.30 x 0.38 (7.6 x 9.5) | 0.12 - 0.12 (3.0 - 3.0) | 106 | 5000 |
| PDL-1VF | | White | 0.50 x 1.44 (12.7 x 36.5) | 0.50 x 0.50 (12.7 x 12.7) | | 0.16 - 0.30 (4.0 - 7.6) | 106 |
| PDL-8VF | | White | 0.80 x 1.44 (20.3 x 36.5) | 0.80 x 0.50 (20.3 x 12.7) | 107 | | 5000 |
| PDL-249VF | | White | 1.00 x 0.75 (25.4 x 19.1) | 1.00 x 0.38 (25.4 x 9.5) | 0.12 - 0.12 (3.0 - 3.0) | | 107 |
| PDL-2VF | | White | 1.00 x 1.44 (25.4 x 36.5) | 1.00 x 0.50 (25.4 x 12.7) | 0.16 - 0.30 (4.0 - 7.6) | 108 | 5000 |
| PDL-4VF | | White | 1.00 x 2.44 (25.4 x 61.9) | 1.00 x 0.75 (25.4 x 19.1) | 0.24 - 0.54 (6.1 - 13.7) | 108 | 1000 |
| PDL-6VF | | White | 1.00 x 3.94 (25.4 x 100.1) | 1.00 x 1.00 (25.4 x 25.4) | 0.32 - 0.94 (8.1 - 23.8) | 109 | 1000 |
| PDL-3VF | | White | 2.00 x 1.44 (50.8 x 36.5) | 2.00 x 0.50 (50.8 x 12.7) | 0.16 - 0.30 (4.0 - 7.6) | 110 | 5000 |
| PDL-5VF-10 | | White | 2.00 x 2.44 (50.8 x 61.9) | 2.00 x 0.75 (50.8 x 19.1) | 0.24 - 0.54 (6.1 - 13.7) | 110 | 10,000 |
| PDL-7VF | | White | 2.00 x 3.94 (50.8 x 100.1) | 2.00 x 1.00 (50.8 x 25.4) | 0.32 - 0.94 (8.1 - 23.8) | 111 | 1000 |

*Refer to Wire Size Selection Guide on page 196 to review diameters of commonly used cables

Dot-Matrix Labeling Products

Self-Laminating Labels by Material (cont.)



GMT1 Self-Laminating TEDLAR[▲] Labels - Indoor / Outdoor Applications

- Preferred material for construction, utility and high temperature applications
- Self-extinguishing and exceeds 94V-0 flammability requirements
- Some sizes are available with a colored strip for group identification
- Use with Panduit Indelible Ink Ribbons found on [pages 126 - 128](#)

| Part Number | Material | Print-On Area Color | Label Size Width x Length In. (mm) | Print-On Area Width x Length In. (mm) | Nominal Cable Outside Diameter [■] In. (mm) | Dwg. Page No. | Std. Pkg. Qty.* |
|-------------|--|---------------------|------------------------------------|---------------------------------------|--|--------------------------|-----------------|
| PDL-238 | GMT1 Self-Laminating TEDLAR [▲] | White | 0.30 x 0.75 (7.6 x 19.1) | 0.30 x 0.38 (7.6 x 9.5) | 0.12 - 0.12 (3.0 - 3.0) | 106 | 5000 |
| PDL-240 | | White | 0.30 x 0.94 (7.6 x 23.8) | 0.30 x 0.38 (7.6 x 9.5) | 0.12 - 0.18 (3.0 - 4.6) | 106 | 5000 |
| PDL-169 | | White | 0.36 x 0.94 (9.14 x 23.8) | 0.36 x 0.38 (9.14 x 9.5) | | 106 | 5000 |
| PDL-118-1 | | White | 0.50 x 0.75 (12.7 x 19.1) | 0.50 x 0.38 (12.7 x 9.5) | 0.12 - 0.12 (3.0 - 3.0) | 106 | 1000 |
| PDL-118 | | White | 0.50 x 0.75 (12.7 x 19.1) | 0.50 x 0.38 (12.7 x 9.5) | | 106 | 5000 |
| PDL-118-10 | | White | 0.50 x 0.75 (12.7 x 19.1) | 0.50 x 0.38 (12.7 x 9.5) | | 106 | 10,000 |
| PDL-88 | | White | 0.50 x 0.75 (12.7 x 19.1) | 0.50 x 0.38 (12.7 x 9.5) | | 106 | 5000 |
| PDL-242 | | White | 0.50 x 0.94 (12.7 x 23.8) | 0.50 x 0.38 (12.7 x 9.5) | 0.12 - 0.18 (3.0 - 4.6) | 106 | 5000 |
| PDL-53† | | White | 0.50 x 1.38 (12.7 x 34.9) | 0.50 x 0.50 (12.7 x 12.7) | 0.16 - 0.28 (4.0 - 7.1) | 106 | 5000 |
| PDL-53-10 | | White | 0.50 x 1.38 (12.7 x 34.9) | 0.50 x 0.50 (12.7 x 12.7) | | 106 | 10,000 |
| PDL-61 | | White | 0.50 x 1.44 (12.7 x 36.5) | 0.50 x 0.50 (12.7 x 12.7) | 0.16 - 0.30 (4.0 - 7.6) | 106 | 5000 |
| PDL-244 | | White | 0.75 x 1.75 (19.1 x 44.5) | 0.75 x 0.50 (19.1 x 12.7) | 0.16 - 0.40 (4.0 - 10.1) | 107 | 5000 |
| PDL-246 | | White | 0.80 x 0.94 (20.3 x 23.8) | 0.80 x 0.38 (20.3 x 9.5) | 0.12 - 0.18 (3.0 - 4.6) | 107 | 5000 |
| PDL-60† | | White | 0.80 x 1.44 (20.3 x 36.5) | 0.80 x 0.50 (20.3 x 12.7) | 0.16 - 0.30 (4.0 - 7.6) | 107 | 5000 |
| PDL-248 | | White | 1.00 x 0.75 (25.4 x 19.1) | 1.00 x 0.38 (25.4 x 9.5) | 0.12 - 0.12 (3.0 - 3.0) | 107 | 5000 |
| PDL-250 | | White | 1.00 x 0.94 (25.4 x 23.8) | 1.00 x 0.38 (25.4 x 9.5) | 0.12 - 0.18 (3.0 - 4.6) | 107 | 5000 |
| PDL-54† | | White | 1.00 x 1.38 (25.4 x 34.9) | 1.00 x 0.50 (25.4 x 12.7) | 0.16 - 0.28 (4.0 - 7.1) | 108 | 5000 |
| PDL-56† | | White | 1.00 x 2.44 (25.4 x 61.9) | 1.00 x 0.75 (25.4 x 19.1) | 0.24 - 0.54 (6.1 - 13.7) | 108 | 1000 |
| PDL-58† | | White | 1.00 x 3.87 (25.4 x 98.3) | 1.00 x 1.00 (25.4 x 25.4) | 0.32 - 0.91 (8.1 - 23.2) | 109 | 1000 |
| PDL-123 | | White | 1.00 x 5.94 (25.4 x 150.9) | 1.00 x 1.50 (25.4 x 38.1) | 0.48 - 1.41 (12.1 - 35.9) | 109 | 1000 |
| PDL-95 | | White | 1.00 x 5.94 (25.4 x 150.9) | 1.00 x 1.50 (25.4 x 38.1) | | 109 | 1000 |
| PDL-125 | | White | 1.00 x 7.44 (25.4 x 189.0) | 1.00 x 1.50 (25.4 x 38.1) | 0.48 - 1.89 (12.1 - 48.0) | 109 | 1000 |
| PDL-96 | | White | 1.00 x 7.44 (25.4 x 189.0) | 1.00 x 1.50 (25.4 x 38.1) | | 109 | 1000 |
| PDL-108 | | White | 1.90 x 3.19 (48.3 x 81.0) | 1.90 x 0.75 (48.3 x 19.1) | | 0.24 - 0.78 (6.1 - 19.7) | 110 |
| PDL-64 | | White | 1.90 x 3.19 (48.3 x 81.0) | 1.90 x 0.75 (48.3 x 19.1) | 110 | | 1000 |
| PDL-55† | | White | 2.00 x 1.38 (50.8 x 34.9) | 2.00 x 0.50 (50.8 x 12.7) | 0.16 - 0.28 (4.0 - 7.1) | 110 | 5000 |
| PDL-57† | | White | 2.00 x 2.44 (50.8 x 61.9) | 2.00 x 0.75 (50.8 x 19.1) | 0.24 - 0.54 (6.1 - 13.7) | 110 | 1000 |
| PDL-59† | | White | 2.00 x 3.87 (50.8 x 98.3) | 2.00 x 1.00 (50.8 x 25.4) | 0.32 - 0.91 (8.1 - 23.2) | 111 | 1000 |
| PDL-59-10 | | White | 2.00 x 3.87 (50.8 x 98.3) | 2.00 x 1.00 (50.8 x 25.4) | | 111 | 10,000 |
| PDL-134 | | White | 2.00 x 5.94 (50.8 x 150.9) | 2.00 x 1.50 (50.8 x 38.1) | 0.48 - 1.41 (12.1 - 35.9) | 111 | 1000 |
| PDL-62 | | White | 2.00 x 5.94 (50.8 x 150.9) | 2.00 x 1.50 (50.8 x 38.1) | | 111 | 1000 |
| PDL-116 | | White | 2.00 x 7.44 (50.8 x 189.0) | 2.00 x 1.50 (50.8 x 38.1) | 0.48 - 1.89 (12.1 - 48.0) | 111 | 1000 |
| PDL-63 | | White | 2.00 x 7.44 (50.8 x 189.0) | 2.00 x 1.50 (50.8 x 38.1) | | 111 | 1000 |

*Refer to Wire Size Selection Guide on [page 196](#) to review diameters of commonly used cables

†Labels available with colored strip on left hand side of label; to order, add the following letter to part number: B for Blue, BR for Brown, G for Green, GR for Gray, OR for Orange, PR for Purple, R for Red, Y for Yellow.

▲TEDLAR is the registered trademark of E. I. DuPont Co.

Blank Labels by Material



Wire Marking

- Can be used as a wrap around label or flag marker
- Unique adhesive allows label to be removed, repositioned and reused
- User places the label on a loose wire, removes the label to terminate the wire and then places label back on the terminated wire
- Ideal for panel building applications
- Use with Panduit Indelible Ink Ribbons found on [pages 126 - 128](#)



Terminal Block Marking

- Ideal for temporary marking of terminal blocks
- Label can be removed without leaving any adhesive residue
- Labels can be re-applied several times due to unique adhesive

GMC Vinyl Cloth - Indoor Applications

| Part Number | Material | Color | Label Size Width x Length In. (mm) | Dwg. Page No. | Std. Pkg. Qty.* |
|-------------|-----------------|---------------------------|--|---------------|------------------------|
| PDL-176 | GMC Vinyl Cloth | White | 0.25 x 1.44 (6.4 x 36.6) | 112 | 5000 |
| PDL-347 | | White | 0.28 x 0.25 (7.1 x 6.4)• | 112 | 1 Roll (28,000 Labels) |
| PDL-254 | | White | 0.30 x 0.75 (7.6 x 19.1) | 112 | 5000 |
| PDL-257 | | White | 0.30 x 0.94 (7.6 x 23.8) | 112 | 5000 |
| PDL-351 | | White | 0.31 x 0.38 (7.9 x 9.5)• | 112 | 1 Roll (18,670 Labels) |
| PDL-353 | | White | 0.31 x 0.50 (7.9 x 12.7)• | 112 | 1 Roll (14,000 Labels) |
| PDL-349 | | White | 0.31 x 700 (7.9 x 17780)• | 112 | 1 Roll (10 Labels) |
| PDL-260 | | White | 0.38 x 0.38 (9.5 x 9.5) | 112 | 5000 |
| PDL-180 | | White | 0.38 x 1.44 (9.5 x 36.6) | 112 | 5000 |
| PDL-355 | | White | 0.38 x 700 (9.5 x 17780)• | 112 | 1 Roll (8 Labels) |
| PDL-102 | | White | 0.44 x 2.56 (11.1 x 65.0) | 112 | 5000 |
| PDL-106-1 | | White | 0.44 x 3.63 (11.1 x 92.1) | 113 | 1000 |
| PDL-106 | | White | 0.44 x 3.63 (11.1 x 92.1) | 113 | 5000 |
| PDL-106-10 | | White | 0.44 x 3.63 (11.1 x 92.1) | 113 | 10,000 |
| PDL-45-1 | | White | 0.50 x 0.44 (12.7 x 11.1) | 113 | 1000 |
| PDL-45 | | White | 0.50 x 0.44 (12.7 x 11.1) | 113 | 5000 |
| PDL-45-10 | | White | 0.50 x 0.44 (12.7 x 11.1) | 113 | 10,000 |
| PDL-119 | | White | 0.50 x 0.75 (12.7 x 19.1) | 113 | 5000 |
| PDL-43 | | White | 0.50 x 0.75 (12.7 x 19.1) | 113 | 5000 |
| PDL-43-10 | | White | 0.50 x 0.75 (12.7 x 19.1) | 113 | 10,000 |
| PDL-265 | | White | 0.50 x 0.94 (12.7 x 23.8) | 113 | 5000 |
| PDL-13-1 | | White | 0.50 x 1.44 (12.7 x 36.5) | 113 | 1000 |
| PDL-13 | | White | 0.50 x 1.44 (12.7 x 36.5) | 113 | 5000 |
| PDL-13-10 | | White | 0.50 x 1.44 (12.7 x 36.5) | 113 | 10,000 |
| PDL-184 | | White | 0.50 x 1.44 (12.7 x 36.5) | 113 | 5000 |
| PDL-135 | | White | 0.50 x 1.44 (12.7 x 36.5) With Horizontal Slit | 114 | 5000 |
| PDL-193 | | Yellow | 0.59 x 0.35 (15.0 x 9.0) | 114 | 5000 |
| PDL-194 | | White | 0.59 x 0.35 (15.0 x 9.0) | 114 | 5000 |
| PDL-34-1 | | White | 0.65 x 0.20 (16.5 x 5.1) | 114 | 1000 |
| PDL-34 | | White | 0.65 x 0.20 (16.5 x 5.1) | 114 | 5000 |
| PDL-34-10 | | White | 0.65 x 0.20 (16.5 x 5.1) | 114 | 10,000 |
| PDL-270 | | White | 0.75 x 0.25 (19.1 x 6.4) | 115 | 5000 |
| PDL-37-1 | | White | 0.75 x 0.25 (19.1 x 6.4) | 115 | 1000 |
| PDL-37 | | White | 0.75 x 0.25 (19.1 x 6.4) | 115 | 5000 |
| PDL-37-10 | | White | 0.75 x 0.25 (19.1 x 6.4) | 115 | 10,000 |
| PDL-37-50 | | White | 0.75 x 0.25 (19.1 x 6.4) | 115 | 50,000 |
| PDL-191 | | Yellow | 0.79 x 0.32 (20.0 x 8.0) | 115 | 5000 |
| PDL-192 | | White | 0.79 x 0.32 (20.0 x 8.0) | 115 | 5000 |
| PDL-280 | | White | 0.80 x 0.94 (20.3 x 23.8) | 116 | 5000 |
| PDL-280-10 | | White | 0.80 x 0.94 (20.3 x 23.8) | 116 | 10,000 |
| PDL-9 | White | 0.80 x 1.44 (20.3 x 36.5) | 116 | 5000 | |
| PDL-9-10 | White | 0.80 x 1.44 (20.3 x 36.5) | 116 | 10,000 | |
| PDL-9-10T• | White | 0.80 x 1.44 (20.3 x 36.5) | 116 | 10,000 | |
| PDL-66 | White | 0.90 x 0.25 (22.9 x 6.4) | 116 | 5000 | |
| PDL-93 | White | 0.90 x 0.25 (22.9 x 6.4) | 116 | 5000 | |
| PDL-30-1 | White | 1.00 x 0.38 (25.4 x 9.5) | 116 | 1000 | |
| PDL-30 | White | 1.00 x 0.38 (25.4 x 9.5) | 116 | 5000 | |
| PDL-30-10 | White | 1.00 x 0.38 (25.4 x 9.5) | 116 | 10,000 | |

More sizes shown on the following page

Blank Labels by Material (cont.)



Electronic Labeling

- Ideal for temporary marking of chips, boards or IC's
- Label is removable without leaving any adhesive residue
- Labels can be re-applied several times due to unique adhesive
- Pliable material is good for rough texture surfaces



Bin Marking

- Unique adhesive allows label to be removed, repositioned and reused — ideal for stock room changes
- Pliable material good for rough textured surfaces, such as concrete

GMC Vinyl Cloth - Indoor Applications (cont.)

| Part Number | Material | Color | Label Size Width x Length In. (mm) | Dwg. Page No. | Std. Pkg. Qty.* |
|-------------|-----------------|-----------------------------|---|---------------|-----------------|
| PDL-19-1 | GMC Vinyl Cloth | White | 1.00 x 0.50 (25.4 x 12.7) | 117 | 1000 |
| PDL-19 | | White | 1.00 x 0.50 (25.4 x 12.7) | 117 | 5000 |
| PDL-19-10 | | White | 1.00 x 0.50 (25.4 x 12.7) | 117 | 10,000 |
| PDL-288 | | White | 1.00 x 0.75 (25.4 x 19.1) | 117 | 5000 |
| PDL-291 | | White | 1.00 x 0.94 (25.4 x 23.8) | 117 | 5000 |
| PDL-294 | | White | 1.00 x 1.44 (25.4 x 36.5) With Horizontal Perforation | 117 | 5000 |
| PDL-4674-1 | | White | 1.13 x 0.53 (28.6 x 13.5) | 117 | 20,000 |
| PDL-130 | | White | 1.25 x 0.38 (31.8 x 9.5) | 118 | 5000 |
| PDL-69 | | White | 1.25 x 0.38 (31.8 x 9.5) | 118 | 5000 |
| PDL-360-10 | | White | 1.50 x 0.25 (38.1 x 6.4) With Vertical Perforation | 118 | 10,000 |
| PDL-41-1 | | White | 1.50 x 0.25 (38.1 x 6.4) With Vertical Perforation | 118 | 1000 |
| PDL-41 | | White | 1.50 x 0.25 (38.1 x 6.4) With Vertical Perforation | 118 | 5000 |
| PDL-41-10 | | White | 1.50 x 0.25 (38.1 x 6.4) With Vertical Perforation | 118 | 10,000 |
| PDL-72 | | White | 1.50 x 0.75 (38.1 x 19.1) | 119 | 5000 |
| PDL-297 | | Yellow | 1.50 x 0.90 (38.1 x 22.9) | 119 | 1000 |
| PDL-298 | | White | 1.50 x 0.90 (38.1 x 22.9) | 119 | 1000 |
| PDL-114 | | White | 2.00 x 0.38 (50.8 x 9.5) | 119 | 5000 |
| PDL-32-1 | | White | 2.00 x 0.38 (50.8 x 9.5) | 119 | 1000 |
| PDL-32 | | White | 2.00 x 0.38 (50.8 x 9.5) | 119 | 5000 |
| PDL-32-10 | | White | 2.00 x 0.38 (50.8 x 9.5) | 119 | 10,000 |
| PDL-147 | | White | 2.00 x 1.25 (50.8 x 31.8) | 119 | 1000 |
| PDL-164 | | White | 2.80 x 1.00 (71.1 x 25.4) | 120 | 1000 |
| PDL-166 | | White | 2.80 x 1.50 (71.1 x 38.1) | 120 | 1000 |
| PDL-33 | | White | 3.00 x 0.38 (76.2 x 9.5) | 120 | 5000 |
| PDL-307 | | Yellow | 3.00 x 0.90 (76.2 x 22.9) | 120 | 1000 |
| PDL-308 | | White | 3.00 x 0.90 (76.2 x 22.9) | 120 | 1000 |
| PDL-142 | | White | 3.00 x 2.00 (76.2 x 50.8) | 120 | 1000 |
| PDL-153 | | White | 3.25 x 1.25 (82.6 x 31.8) | 120 | 1000 |
| PDL-160 | | White | 3.63 x 1.00 (92.1 x 25.4) | 121 | 5000 |
| PDL-162 | | White | 3.63 x 1.50 (92.1 x 38.1) | 121 | 5000 |
| PDL-321 | | Yellow | 3.90 x 0.90 (99.1 x 22.9) | 121 | 1000 |
| PDL-322 | | White | 3.90 x 0.90 (99.1 x 22.9) | 121 | 1000 |
| PDL-323 | | Yellow | 3.90 x 1.44 (99.1 x 36.5) | 121 | 1000 |
| PDL-324 | | White | 3.90 x 1.44 (99.1 x 36.5) | 121 | 1000 |
| PDL-329 | | Yellow | 3.90 x 2.90 (99.1 x 73.7) | 121 | 1000 |
| PDL-330 | | White | 3.90 x 2.90 (99.1 x 73.7) | 121 | 1000 |
| PDL-331 | | Yellow | 6.00 x 0.90 (152.4 x 22.9) | 121 | 1000 |
| PDL-332 | | White | 6.00 x 0.90 (152.4 x 22.9) | 121 | 1000 |
| PDL-333 | | Yellow | 6.00 x 1.44 (152.4 x 36.6) | 121 | 1000 |
| PDL-334 | | White | 6.00 x 1.44 (152.4 x 36.6) | 121 | 1000 |
| PDL-335 | | Yellow | 6.00 x 1.90 (152.4 x 48.3) | 121 | 1000 |
| PDL-336 | | White | 6.00 x 1.90 (152.4 x 48.3) | 121 | 1000 |
| PDL-337 | Yellow | 6.00 x 2.90 (152.4 x 73.7) | 121 | 1000 | |
| PDL-338 | White | 6.00 x 2.90 (152.4 x 73.7) | 121 | 1000 | |
| PDL-341 | Yellow | 8.00 x 1.44 (203.2 x 36.5) | 121 | 1000 | |
| PDL-342 | White | 8.00 x 1.44 (203.2 x 36.5) | 121 | 1000 | |
| PDL-343 | Yellow | 12.00 x 1.90 (304.8 x 48.3) | 121 | 1000 | |
| PDL-344 | White | 12.00 x 1.90 (304.8 x 48.3) | 121 | 1000 | |
| PDL-345 | Yellow | 12.00 x 2.90 (304.8 x 73.7) | 121 | 1000 | |
| PDL-346 | White | 12.00 x 2.90 (304.8 x 73.7) | 121 | 1000 | |

*Order number of labels required in multiples of Std. Pkg. Qty.

Blank Labels by Material (cont.)

- Resistant to solvents and high temperatures
- Use with Panduit Indelible Ink Ribbons found on [pages 126 - 128](#)

GMA Aluminum - Indoor Applications

| Part Number | Material | Color | Label Size Width x Length In. (mm) | Dwg. Page No. | Std. Pkg. Qty.* |
|-------------|--------------|--------|------------------------------------|---------------|-----------------|
| PDL-97 | GMA Aluminum | Silver | 1.00 x 0.50 (25.4 x 12.7) | 117 | 5000 |
| PDL-148 | | Silver | 2.00 x 1.25 (50.8 x 31.8) | 119 | 1000 |
| PDL-143 | | Silver | 3.00 x 2.00 (76.2 x 50.8) | 120 | 1000 |
| PDL-154 | | Silver | 3.25 x 1.25 (82.6 x 31.8) | 120 | 1000 |



GMC-FR Rag Tag Label (Non-Adhesive with Liner) -Indoor Applications

| Part Number | Material | Color | Label Size In. (mm) | | | | Labels Per Roll | Std. Pkg. Qty.* |
|-------------|------------------------------|-------|---------------------|-------------|-------------|-------------|-----------------|-----------------|
| | | | A | B | C | D | | |
| PDL-500 | GMC-FR Flame Retardant Cloth | White | 4.50 (114.3) | 1.00 (25.4) | 0.50 (12.7) | 2.25 (57.1) | 1800 | 1 Roll |



- Used for harness identification
- Will not damage wires or cable with adhesive residue
- Flame retardant GMC-FR material meets U.L. 94-VTM0
- IBM Approval LER440



GMK Polyimide - Indoor Applications

| Part Number | Material | Color | Label Size Width x Length In. (mm) | Dwg. Page No. | Std. Pkg. Qty.* |
|-------------|---------------|-------|--|---------------|-----------------|
| PDL-252 | GMK Polyimide | Amber | 0.30 x 0.30 (7.6 x 7.6) | 112 | 5000 |
| PDL-252-10 | | Amber | 0.30 x 0.30 (7.6 x 7.6) | 112 | 10,000 |
| PDL-262 | | Amber | 0.38 x 0.38 (9.5 x 9.5) | 112 | 5000 |
| PDL-262-10 | | Amber | 0.38 x 0.38 (9.5 x 9.5) | 112 | 10,000 |
| PDL-233 | | Amber | 0.65 x 0.20 (16.5 x 5.1) | 114 | 5000 |
| PDL-233-10 | | Amber | 0.65 x 0.20 (16.5 x 5.1) | 114 | 10,000 |
| PDL-235 | | Amber | 0.75 x 0.25 (19.1 x 6.4) | 115 | 5000 |
| PDL-235-10 | | Amber | 0.75 x 0.25 (19.1 x 6.4) | 115 | 10,000 |
| PDL-272 | | Amber | 0.75 x 0.25 (19.1 x 6.4) | 115 | 5000 |
| PDL-276 | | Amber | 0.75 x 0.25 (19.1 x 6.4) With Tamper Resistant Slits | 115 | 5000 |
| PDL-278 | | Amber | 0.80 x 0.20 (20.3 x 5.1) | 115 | 5000 |
| PDL-173 | | Amber | 0.80 x 0.50 (20.3 x 12.7) | 115 | 5000 |
| PDL-283 | | Amber | 0.90 x 0.25 (22.9 x 6.4) | 116 | 5000 |
| PDL-50 | | Amber | 0.90 x 0.25 (22.9 x 6.4) | 116 | 5000 |
| PDL-50-10 | | Amber | 0.90 x 0.25 (22.9 x 6.4) | 116 | 10,000 |
| PDL-286 | | Amber | 0.90 x 0.25 (22.9 x 6.4) With Tamper Resistant Slits | 116 | 5000 |
| PDL-98 | | Amber | 1.00 x 0.50 (25.4 x 12.7) | 117 | 5000 |
| PDL-357 | | Amber | 1.50 x 0.25 (38.1 x 6.4) | 118 | 5000 |
| PDL-237 | | Amber | 2.00 x 0.38 (50.8 x 9.5) | 119 | 5000 |
| PDL-232 | | Amber | 3.00 x 0.38 (76.2 x 9.5) | 120 | 5000 |

- Can withstand high temperatures, ideal for components in direct contact with molten solder
- Resistant to most solvent washes
- Meets MIL Spec 202F
- Use with Panduit Indelible Ink Ribbons found on [pages 126 - 128](#)
- Polyimide is commonly called KAPTON*

* KAPTON is a registered trademark of E. I. DuPont Co.

Blank Labels by Material (cont.)

- Ideal for temporary labeling
- Low cost identification on boards and chips
- Labels provide good contrast for easy bar code scanning

GMP Removable Paper - Indoor Applications

| Part Number | Material | Color | Label Size Width x Length In. (mm) | Dwg. Page No. | Std. Pkg. Qty.* |
|-------------|---------------------|-------|--|---------------|-----------------|
| PDL-91 | GMP Removable Paper | White | 0.50 x 0.44 (12.7 x 11.1) | 113 | 5000 |
| PDL-170 | | White | 0.80 x 0.50 (20.3 x 12.7) | 115 | 5000 |
| PDL-170-10 | | White | 0.80 x 0.50 (20.3 x 12.7) | 115 | 10,000 |
| PDL-65 | | White | 1.00 x 0.50 (25.4 x 12.7) | 117 | 5000 |
| PDL-359-10 | | White | 1.50 x 0.25 (38.1 x 6.4) With Vertical Perforation | 118 | 10,000 |
| PDL-40 | | White | 1.50 x 0.25 (38.1 x 6.4) With Vertical Perforation | 118 | 5000 |
| PDL-40-10 | | White | 1.50 x 0.25 (38.1 x 6.4) With Vertical Perforation | 118 | 10,000 |
| PDL-299 | | White | 2.00 x 0.90 (50.8 x 22.9) | 119 | 1000 |
| PDL-303 | | White | 2.00 x 1.44 (50.8 x 36.5) | 120 | 1000 |
| PDL-309 | | White | 3.00 x 0.90 (76.2 x 22.9) | 120 | 1000 |
| PDL-313 | | White | 3.00 x 1.44 (76.2 x 36.5) | 120 | 1000 |
| PDL-317 | | White | 3.00 x 1.90 (76.2 x 48.3) | 120 | 1000 |
| PDL-325 | | White | 3.90 x 1.44 (99.1 x 36.5) | 120 | 1000 |
| PDL-339 | | White | 6.00 x 3.94 (152.4 x 100.0) | 121 | 1000 |



- Strong permanent adhesive will leave traces of label after removal
- Low cost identification on board and chips
- Good contrast for easy bar code scanning

GMP1 Destructible Paper - Indoor Applications

| Part Number | Material | Color | Label Size Width x Length In. (mm) | Dwg. Page No. | Std. Pkg. Qty.* |
|-------------|-------------------------|-------|--|---------------|-----------------|
| PDL-122 | GMP1 Destructible Paper | White | 0.50 x 0.75 (12.7 x 19.1) | 113 | 5000 |
| PDL-89 | | White | 0.50 x 0.75 (12.7 x 19.1) | 113 | 5000 |
| PDL-138 | | White | 0.50 x 1.44 (12.7 x 36.5) With Horizontal Slit | 114 | 5000 |
| PDL-82 | | White | 0.65 x 0.20 (16.5 x 5.1) | 114 | 5000 |
| PDL-85 | | White | 0.75 x 0.25 (19.1 x 6.4) | 115 | 5000 |
| PDL-167 | | White | 0.80 x 0.25 (20.3 x 6.4) | 115 | 5000 |
| PDL-174 | | White | 0.80 x 0.50 (20.3 x 12.7) | 115 | 5000 |
| PDL-67 | | White | 0.90 x 0.25 (22.9 x 6.4) | 116 | 5000 |
| PDL-92 | | White | 0.90 x 0.25 (22.9 x 6.4) | 116 | 5000 |
| PDL-74 | | White | 1.00 x 0.38 (25.4 x 9.5) | 116 | 5000 |
| PDL-370 | | White | 1.25 x 0.38 (31.8 x 9.5) | 118 | 5000 |
| PDL-70 | | White | 1.25 x 0.38 (31.8 x 9.5) | 118 | 5000 |
| PDL-73 | | White | 1.50 x 0.75 (38.1 x 19.1) | 119 | 5000 |
| PDL-73-10 | | White | 1.50 x 0.75 (38.1 x 19.1) | 119 | 10,000 |
| PDL-112 | | White | 2.00 x 0.38 (50.8 x 9.5) | 119 | 5000 |
| PDL-78 | | White | 2.00 x 0.38 (50.8 x 9.5) | 119 | 5000 |
| PDL-300 | | White | 2.00 x 0.90 (50.8 x 22.9) | 119 | 1000 |
| PDL-149 | | White | 2.00 x 1.25 (50.8 x 31.8) | 119 | 1000 |
| PDL-304 | | White | 2.00 x 1.44 (50.8 x 36.5) | 120 | 1000 |
| PDL-163 | | White | 2.80 x 1.00 (71.1 x 25.4) | 120 | 1000 |
| PDL-165 | | White | 2.80 x 1.50 (71.1 x 38.1) | 120 | 1000 |
| PDL-81 | | White | 3.00 x 0.38 (76.2 x 9.5) | 120 | 5000 |
| PDL-310 | | White | 3.00 x 0.90 (76.2 x 22.9) | 120 | 1000 |
| PDL-314 | | White | 3.00 x 1.44 (76.2 x 36.5) | 120 | 1000 |
| PDL-318 | | White | 3.00 x 1.90 (76.2 x 48.3) | 120 | 1000 |
| PDL-141 | | White | 3.00 x 2.00 (76.2 x 50.8) | 120 | 1000 |
| PDL-155 | | White | 3.25 x 1.25 (82.6 x 31.8) | 120 | 1000 |
| PDL-159 | | White | 3.63 x 1.00 (92.1 x 25.4) | 121 | 5000 |
| PDL-161 | | White | 3.63 x 1.50 (92.1 x 38.1) | 121 | 5000 |
| PDL-326 | | White | 3.90 x 1.44 (99.1 x 36.5) | 121 | 1000 |
| PDL-340 | | White | 6.00 x 3.94 (152.4 x 100.0) | 121 | 1000 |

*Order number of labels required in multiples of Std. Pkg. Qty.

Blank Labels by Material (cont.)



- Economical
- Can be used for wire marking as a wrap around label or flag marker
- Use with Panduit Indelible Ink Ribbons found on **pages 126 - 128**

GMV Vinyl - Indoor Applications

| Part Number | Material | Color | Label Size Width x Length In. (mm) | Dwg. Page No. | Std. Pkg. Qty.* |
|-------------|-----------|-------|--|---------------|-----------------|
| PDL-178 | GMV Vinyl | White | 0.25 x 1.44 (6.4 x 36.6) | 112 | 5000 |
| PDL-182 | | White | 0.38 x 1.44 (9.5 x 36.6) | 112 | 5000 |
| PDL-103 | | White | 0.44 x 2.56 (11.1 x 65.0) | 112 | 5000 |
| PDL-107 | | White | 0.44 x 3.63 (11.1 x 92.1) | 113 | 5000 |
| PDL-15 | | White | 0.50 x 1.44 (12.7 x 36.5) | 113 | 5000 |
| PDL-186 | | White | 0.50 x 1.44 (12.7 x 36.5) | 113 | 5000 |
| PDL-189 | | White | 0.65 x 0.20 (16.5 x 5.1) | 114 | 5000 |
| PDL-190 | | White | 0.75 x 0.25 (19.1 x 6.4) | 115 | 5000 |
| PDL-171 | | White | 0.80 x 0.50 (20.3 x 12.7) | 115 | 5000 |
| PDL-11 | | White | 0.80 x 1.44 (20.3 x 36.5) | 116 | 5000 |
| PDL-188 | | White | 1.00 x 0.50 (25.4 x 12.7) | 117 | 5000 |
| PDL-132 | | White | 1.25 x 0.38 (31.8 x 9.5) | 118 | 5000 |
| PDL-132-10 | | White | 1.25 x 0.38 (31.8 x 9.5) | 118 | 10,000 |
| PDL-629 | | White | 1.50 x 0.25 (38.1 x 6.4) With Vertical Perforation | 118 | 5000 |
| PDL-113 | | White | 2.00 x 0.38 (50.8 x 9.5) | 119 | 5000 |
| PDL-146 | | White | 2.00 x 1.25 (50.8 x 31.8) | 119 | 1000 |
| PDL-140 | | White | 3.00 x 2.00 (76.2 x 50.8) | 120 | 1000 |
| PDL-152 | | White | 3.25 x 1.25 (82.6 x 31.8) | 120 | 1000 |



- Strong permanent adhesive, destructible material
- Tamper evident and hard to remove
- Damages most surfaces upon removal of label

GMV10 Destructible Vinyl - Indoor Applications

| Part Number | Material | Color | Label Size Width x Length In. (mm) | Dwg. Page No. | Std. Pkg. Qty.* |
|-------------|--------------------------|-------|------------------------------------|---------------|-----------------|
| PDL-263 | GMV10 Destructible Vinyl | White | 0.38 x 0.38 (9.5 x 9.5) | 112 | 5000 |
| PDL-46 | | White | 0.50 x 0.44 (12.7 x 11.1) | 113 | 5000 |
| PDL-35-1 | | White | 0.65 x 0.20 (16.5 x 5.1) | 114 | 1000 |
| PDL-35 | | White | 0.65 x 0.20 (16.5 x 5.1) | 114 | 5000 |
| PDL-35-10 | | White | 0.65 x 0.20 (16.5 x 5.1) | 114 | 10,000 |
| PDL-273 | | White | 0.75 x 0.25 (19.1 x 6.4) | 115 | 5000 |
| PDL-38 | | White | 0.75 x 0.25 (19.1 x 6.4) | 115 | 5000 |
| PDL-38-10 | | White | 0.75 x 0.25 (19.1 x 6.4) | 115 | 10,000 |
| PDL-21-1 | | White | 1.00 x 0.50 (25.4 x 12.7) | 117 | 1000 |
| PDL-21 | | White | 1.00 x 0.50 (25.4 x 12.7) | 117 | 5000 |
| PDL-21-10 | | White | 1.00 x 0.50 (25.4 x 12.7) | 117 | 10,000 |
| PDL-7294-1 | | White | 1.00 x 0.50 (25.4 x 12.7) | 117 | 5000 |



GMT TEDLAR[▲] - Indoor/Outdoor Applications

| Part Number | Material | Color | Label Size Width x Length In. (mm) | Dwg. Page No. | Std. Pkg. Qty.* |
|-------------|-------------------------|-------|------------------------------------|---------------|-----------------|
| PDL-179 | GMT TEDLAR [▲] | White | 0.25 x 1.44 (6.4 x 36.6) | 112 | 5000 |
| PDL-7966-10 | | White | 0.30 x 0.20 (7.6 x 5.1) | 112 | 10,000 |
| PDL-256 | | White | 0.30 x 0.75 (7.6 x 19.1) | 112 | 5000 |
| PDL-259 | | White | 0.30 x 0.94 (7.6 x 23.8) | 112 | 5000 |
| PDL-183 | | White | 0.38 x 1.44 (9.5 x 36.6) | 112 | 5000 |
| PDL-100 | | White | 0.44 x 2.56 (11.1 x 65.0) | 112 | 5000 |
| PDL-104 | | White | 0.44 x 3.63 (11.1 x 92.1) | 113 | 5000 |

[▲]TEDLAR is the registered trademark of E. I. DuPont Co

More sizes shown on the following page

Blank Labels by Material (cont.)

Wire Marking

- Can be used as a wrap around label, but is most commonly used as a flag marker on wires and cables
- Used in many OEM and harness house applications with high temperature requirements



Electronic Labeling

- Pliable material is good for curved surfaces
- Use with Panduit Indelible Ink Ribbons found on [pages 126 - 128](#)



Terminal Block Marking

- Strong durable material with permanent adhesive

GMT TEDLAR[▲] - Indoor/Outdoor Applications (cont.)

| Part Number | Material | Color | Label Size Width x Length In. (mm) | Dwg. Page No. | Std. Pkg. Qty.* |
|-------------|-------------------------|----------------------------|---|---------------|-----------------|
| PDL-120 | GMT TEDLAR [▲] | White | 0.50 x 0.75 (12.7 x 19.1) | 113 | 5000 |
| PDL-120-10 | | White | 0.50 x 0.75 (12.7 x 19.1) | 113 | 10,000 |
| PDL-44 | | White | 0.50 x 0.75 (12.7 x 19.1) | 113 | 5000 |
| PDL-267 | | White | 0.50 x 0.94 (12.7 x 23.8) | 113 | 5000 |
| PDL-187 | | White | 0.50 x 1.44 (12.7 x 36.5) | 113 | 5000 |
| PDL-137 | | White | 0.50 x 1.44 (12.7 x 36.5) With Horizontal Slit | 114 | 5000 |
| PDL-83 | | White | 0.65 x 0.20 (16.5 x 5.1) | 114 | 5000 |
| PDL-83-10 | | White | 0.65 x 0.20 (16.5 x 5.1) | 114 | 10,000 |
| PDL-84 | | White | 0.75 x 0.25 (19.1 x 6.4) | 115 | 5000 |
| PDL-282 | | White | 0.80 x 0.94 (20.3 x 23.8) | 116 | 5000 |
| PDL-10-1 | | White | 0.80 x 1.44 (20.3 x 36.5) | 116 | 1000 |
| PDL-10 | | White | 0.80 x 1.44 (20.3 x 36.5) | 116 | 5000 |
| PDL-23-1 | | White | 0.90 x 0.25 (22.9 x 6.4) | 116 | 1000 |
| PDL-23 | | White | 0.90 x 0.25 (22.9 x 6.4) | 116 | 5000 |
| PDL-23-10 | | White | 0.90 x 0.25 (22.9 x 6.4) | 116 | 10,000 |
| PDL-284 | | White | 0.90 x 0.25 (22.9 x 6.4) | 116 | 5000 |
| PDL-49 | | White | 0.90 x 0.25 (22.9 x 6.4) | 116 | 5000 |
| PDL-49-10 | | White | 0.90 x 0.25 (22.9 x 6.4) | 116 | 10,000 |
| PDL-4565-1 | | White | 0.98 x 0.59 (25.0 x 15.0) | 116 | 5000 |
| PDL-75 | | White | 1.00 x 0.38 (25.4 x 9.5) | 116 | 5000 |
| PDL-230 | | Yellow | 1.00 x 0.50 (25.4 x 12.7) | 117 | 5000 |
| PDL-99 | | White | 1.00 x 0.50 (25.4 x 12.7) | 117 | 5000 |
| PDL-99-10 | | White | 1.00 x 0.50 (25.4 x 12.7) | 117 | 10,000 |
| PDL-290-1 | | White | 1.00 x 0.75 (25.4 x 19.1) | 117 | 1000 |
| PDL-290 | | White | 1.00 x 0.75 (25.4 x 19.1) | 117 | 5000 |
| PDL-293 | | White | 1.00 x 0.94 (25.4 x 23.8) | 117 | 5000 |
| PDL-296 | | White | 1.00 x 1.44 (25.4 x 36.5) With Horizontal Perforation | 117 | 5000 |
| PDL-4674-3 | | White | 1.13 x 0.53 (28.6 x 13.5) | 117 | 20,000 |
| PDL-4565-2 | | White | 1.18 x 0.37 (30.0 x 9.5) | 117 | 5000 |
| PDL-127 | | Yellow | 1.25 x 0.38 (31.8 x 9.5) | 118 | 5000 |
| PDL-128 | | White | 1.25 x 0.38 (31.8 x 9.5) | 118 | 5000 |
| PDL-128-10 | | White | 1.25 x 0.38 (31.8 x 9.5) | 118 | 10,000 |
| PDL-129 | | Gray | 1.25 x 0.38 (31.8 x 9.5) | 118 | 5000 |
| PDL-24 | | Yellow | 1.25 x 0.38 (31.8 x 9.5) | 118 | 5000 |
| PDL-25 | | White | 1.25 x 0.38 (31.8 x 9.5) | 118 | 5000 |
| PDL-25-10 | | White | 1.25 x 0.38 (31.8 x 9.5) | 118 | 10,000 |
| PDL-26 | | Silver | 1.25 x 0.38 (31.8 x 9.5) | 118 | 5000 |
| PDL-86 | | White | 1.50 x 0.25 (38.1 x 6.4) With Vertical Perforation | 118 | 5000 |
| PDL-27 | | White | 1.50 x 0.75 (38.1 x 19.1) | 119 | 5000 |
| PDL-27-10 | | White | 1.50 x 0.75 (38.1 x 19.1) | 119 | 10,000 |
| PDL-28 | Yellow | 1.50 x 0.75 (38.1 x 19.1) | 119 | 5000 | |
| PDL-110-1 | White | 2.00 x 0.38 (50.8 x 9.5) | 119 | 1000 | |
| PDL-110 | White | 2.00 x 0.38 (50.8 x 9.5) | 119 | 5000 | |
| PDL-76 | White | 2.00 x 0.38 (50.8 x 9.5) | 119 | 5000 | |
| PDL-7557-1 | White | 2.50 x 4.25 (63.5 x 108.0) | 120 | 1000 | |
| PDL-79 | White | 3.00 x 0.38 (76.2 x 9.5) | 120 | 5000 | |

[▲]TEDLAR is the registered trademark of E. I. DuPont Co

Blank Labels by Material (cont.)

- Durable label material
- Use on colored or clear surfaces
- Use with Panduit Indelible Ink Ribbons found on [pages 126 - 128](#)

GMY-C Polyester - Indoor/Outdoor Applications

| Part Number | Material | Color | Label Size Width x Length In. (mm) | Dwg. Page No. | Std. Pkg. Qty.* |
|-------------|-----------------|-------|------------------------------------|---------------|-----------------|
| PDL-402-D | GMY-C Polyester | Clear | 0.56 x 0.19 (14.3 x 4.8) | 114 | 500 |
| PDL-402-10 | | Clear | 0.56 x 0.19 (14.3 x 4.8) | 114 | 10,000 |
| PDL-401-D | | Clear | 0.56 x 0.56 (14.3 x 14.3) | 114 | 500 |
| PDL-401 | | Clear | 0.56 x 0.56 (14.3 x 14.3) | 114 | 5000 |
| PDL-401-10 | | Clear | 0.56 x 0.56 (14.3 x 14.3) | 114 | 10,000 |
| PDL-363 | | Clear | 1.00 x 0.50 (25.4 x 12.7) | 117 | 5000 |
| PDL-407-1 | | Clear | 1.38 x 0.28 (34.9 x 7.1) | 118 | 1000 |
| PDL110G5 | | Clear | 2.00 x 0.38 (50.8 x 9.5) | 119 | 5000 |
| PDL-404-1 | | Clear | 7.50 x 0.50 (190.5 x 12.7) | 121 | 1000 |
| PDL-404-2.5 | | Clear | 7.50 x 0.50 (190.5 x 12.7) | 121 | 2500 |



Bar Code Labeling

- Durable label material for permanent bar codes
- Can also be used for inventory, asset and equipment labeling



High Temperature Applications

- Adhesive becomes permanent after 24 hours
- Durable label material for the top of circuit boards
- Material Temperature: 310°F (154°C) - 2nd highest temperature rated Panduit material

GMY-W Polyester - Indoor/Outdoor Applications

| Part Number | Material | Color | Label Size Width x Length In. (mm) | Dwg. Page No. | Std. Pkg. Qty.* |
|-------------|-----------------|--|--|---------------|-----------------|
| PDL-177 | GMY-W Polyester | White | 0.25 x 1.44 (6.4 x 36.6) | 112 | 5000 |
| PDL-253 | | White | 0.30 x 0.30 (7.6 x 7.6) | 112 | 5000 |
| PDL-253-10 | | White | 0.30 x 0.30 (7.6 x 7.6) | 112 | 10,000 |
| PDL-264 | | White | 0.38 x 0.38 (9.5 x 9.5) | 112 | 5000 |
| PDL-264-10 | | White | 0.38 x 0.38 (9.5 x 9.5) | 112 | 10,000 |
| PDL-181 | | White | 0.38 x 1.44 (9.5 x 36.6) | 112 | 5000 |
| PDL-101 | | White | 0.44 x 2.56 (11.1 x 65.0) | 112 | 5000 |
| PDL-105 | | White | 0.44 x 3.63 (11.1 x 92.1) | 113 | 5000 |
| PDL-47 | | White | 0.50 x 0.44 (12.7 x 11.1) | 113 | 5000 |
| PDL-47-10 | | White | 0.50 x 0.44 (12.7 x 11.1) | 113 | 10,000 |
| PDL-121 | | White | 0.50 x 0.75 (12.7 x 19.1) | 113 | 5000 |
| PDL-90 | | White | 0.50 x 0.75 (12.7 x 19.1) | 113 | 5000 |
| PDL-14 | | White | 0.50 x 1.44 (12.7 x 36.5) | 113 | 5000 |
| PDL-14-10 | | White | 0.50 x 1.44 (12.7 x 36.5) | 113 | 10,000 |
| PDL-185 | | White | 0.50 x 1.44 (12.7 x 36.5) | 113 | 5000 |
| PDL-136 | | White | 0.50 x 1.44 (12.7 x 36.5) With Horizontal Slit | 114 | 5000 |
| PDL-405-D | | White | 0.56 x 0.19 (14.3 x 4.8) | 114 | 500 |
| PDL-405-10 | | White | 0.56 x 0.19 (14.3 x 4.8) | 114 | 10,000 |
| PDL-406-D | | White | 0.56 x 0.56 (14.3 x 14.3) | 114 | 500 |
| PDL-406-10 | | White | 0.56 x 0.56 (14.3 x 14.3) | 114 | 10,000 |
| PDL-400 | | Electrical Ivory | 0.56 x 0.56 (14.3 x 14.3) | 114 | 5000 |
| PDL-269 | | White | 0.65 x 0.20 (16.5 x 5.1) With Tamper Resistant Slits | 114 | 5000 |
| PDL-36 | | White | 0.65 x 0.20 (16.5 x 5.1) | 114 | 5000 |
| PDL-36-10 | | White | 0.65 x 0.20 (16.5 x 5.1) | 114 | 10,000 |
| PDL-274 | | White | 0.75 x 0.25 (19.1 x 6.4) | 115 | 5000 |
| PDL-274-10 | | White | 0.75 x 0.25 (19.1 x 6.4) | 115 | 10,000 |
| PDL-39 | | White | 0.75 x 0.25 (19.1 x 6.4) | 115 | 5000 |
| PDL-39-10 | White | 0.75 x 0.25 (19.1 x 6.4) | 115 | 10,000 | |
| PDL-277 | White | 0.75 x 0.25 (19.1 x 6.4) With Tamper Resistant Slits | 115 | 5000 | |
| PDL-277-10 | White | 0.75 x 0.25 (19.1 x 6.4) With Tamper Resistant Slits | 115 | 10,000 | |

More sizes shown on the following page

Blank Labels by Material (cont.)



Electronic Labeling

- Adhesive becomes permanent after 24 hours
- Durable material ideal for the top of circuit boards
- Can be used before wave solder process
- UV resistant for outdoor applications, field marking applications
- Material Temperature: 310°F (154°C) - 2nd highest temperature rated Panduit material



Harsh Environment Labeling

- Adhesive becomes permanent after 24 hours
- Durable label material, solvent resistant
- UV resistant for outdoor applications

GMY-W Polyester - Indoor/Outdoor Applications (cont.)

| Part Number | Material | Color | Label Size Width x Length In. (mm) | Dwg. Page No. | Std. Pkg. Qty.* |
|-------------|-----------------|----------------------------|--|---------------|------------------------|
| PDL-279 | GMY-W Polyester | White | 0.80 x 0.20 (20.3 x 5.1) | 115 | 5000 |
| PDL-279-10 | | White | 0.80 x 0.20 (20.3 x 5.1) | 115 | 10,000 |
| PDL-172 | | White | 0.80 x 0.50 (20.3 x 12.7) | 115 | 5000 |
| PDL-172-10 | | White | 0.80 x 0.50 (20.3 x 12.7) | 115 | 10,000 |
| PDL-172R | | White | 0.80 x 0.50 (20.3 x 12.7)• | 115 | 1 Roll (10,000 Labels) |
| PDL-285 | | White | 0.90 x 0.25 (22.9 x 6.4) | 116 | 5000 |
| PDL-94-1 | | White | 0.90 x 0.25 (22.9 x 6.4) | 116 | 1000 |
| PDL-94 | | White | 0.90 x 0.25 (22.9 x 6.4) | 116 | 5000 |
| PDL-94-10 | | White | 0.90 x 0.25 (22.9 x 6.4) | 116 | 10,000 |
| PDL-287 | | White | 0.90 x 0.25 (22.9 x 6.4) With Tamper Resistant Slits | 116 | 5000 |
| PDL-31 | | White | 1.00 x 0.38 (25.4 x 9.5) | 116 | 5000 |
| PDL-31-10 | | White | 1.00 x 0.38 (25.4 x 9.5) | 116 | 10,000 |
| PDL-157 | | White | 1.00 x 0.50 (25.4 x 12.7) | 117 | 5000 |
| PDL-20-1 | | White | 1.00 x 0.50 (25.4 x 12.7) | 117 | 1000 |
| PDL-20 | | White | 1.00 x 0.50 (25.4 x 12.7) | 117 | 5000 |
| PDL-20-10 | | White | 1.00 x 0.50 (25.4 x 12.7) | 117 | 10,000 |
| PDL-131 | | White | 1.25 x 0.38 (31.8 x 9.5) | 118 | 5000 |
| PDL-5712-2 | | White with Red Border | 1.25 x 0.38 (31.8 x 9.5) | 118 | 25,000 |
| PDL-71 | | White | 1.25 x 0.38 (31.8 x 9.5) | 118 | 5000 |
| PDL-409-1 | | White | 1.38 x 0.28 (34.9 x 7.1) | 118 | 1000 |
| PDL-358 | | White | 1.50 x 0.25 (38.1 x 6.4) | 118 | 5000 |
| PDL-87 | | White | 1.50 x 0.25 (38.1 x 6.4) With Vertical Perforation | 118 | 5000 |
| PDL-87-10 | | White | 1.50 x 0.25 (38.1 x 6.4) With Vertical Perforation | 118 | 10,000 |
| PDL-231 | | White | 1.50 x 0.75 (38.1 x 19.1) | 119 | 5000 |
| PDL-231-10 | | White | 1.50 x 0.75 (38.1 x 19.1) | 119 | 10,000 |
| PDL-111-1 | | White | 2.00 x 0.38 (50.8 x 9.5) | 119 | 1000 |
| PDL-111 | | White | 2.00 x 0.38 (50.8 x 9.5) | 119 | 5000 |
| PDL-77 | | White | 2.00 x 0.38 (50.8 x 9.5) | 119 | 5000 |
| PDL-301 | | White | 2.00 x 0.90 (50.8 x 22.9) | 119 | 1000 |
| PDL-150 | | White | 2.00 x 1.25 (50.8 x 31.8) | 119 | 1000 |
| PDL-305 | | White | 2.00 x 1.44 (50.8 x 36.5) | 120 | 1000 |
| PDL-305-10 | | White | 2.00 x 1.44 (50.8 x 36.5) | 120 | 10,000 |
| PDL-80 | | White | 3.00 x 0.38 (76.2 x 9.5) | 120 | 5000 |
| PDL-311 | | White | 3.00 x 0.90 (76.2 x 22.9) | 120 | 1000 |
| PDL-315 | | White | 3.00 x 1.44 (76.2 x 36.5) | 120 | 1000 |
| PDL-319 | | White | 3.00 x 1.90 (76.2 x 48.3) | 120 | 1000 |
| PDL-144 | | White | 3.00 x 2.00 (76.2 x 50.8) | 120 | 1000 |
| PDL-156 | | White | 3.25 x 1.25 (82.6 x 31.8) | 120 | 1000 |
| PDL-327 | | White | 3.90 x 1.44 (99.1 x 36.5) | 121 | 1000 |
| PDL-403-1† | | White | 7.50 x 0.50 (190.5 x 12.7) | 121 | 1000 |
| PDL-403-2.5 | White | 7.50 x 0.50 (190.5 x 12.7) | 121 | 2500 | |

†Label also available in TIA Specified colors for Network Systems applications. To order, add B for Blue, BR for Brown, G for Green, GR for Gray, OR for Orange, PR for Purple, R for Red, Y for Yellow.
 • Indicates label is roll mounted

Blank Labels by Material (cont.)



- UV opaque material used to cover EPROM windows
- Adhesive becomes permanent after 24 hours
- Durable material for the top of circuit boards
- Can be used before wave solder process
- Use with Panduit Indelible Ink Ribbons found on [pages 126 - 128](#)

GYM-S Polyester - Indoor/Outdoor Applications

| Part Number | Material | Color | Label Size Width x Length In. (mm) | Dwg. Page No. | Std. Pkg. Qty.* |
|--------------|--------------------|--------|--|---------------------|-----------------------|
| PDL-48-1 | GYM-S Polyester | Silver | 0.50 x 0.44 (12.7 x 11.1) | 113 | 1000 |
| PDL-48 | | Silver | 0.50 x 0.44 (12.7 x 11.1) | 113 | 5000 |
| PDL-48-10 | | Silver | 0.50 x 0.44 (12.7 x 11.1) | 113 | 10,000 |
| PDL-234 | | Silver | 0.65 x 0.20 (16.5 x 5.1) | 114 | 5000 |
| PDL-234-10 | | Silver | 0.65 x 0.20 (16.5 x 5.1) | 114 | 10,000 |
| PDL-236 | | Silver | 0.75 x 0.25 (19.1 x 6.4) | 115 | 5000 |
| PDL-236-10 | | Silver | 0.75 x 0.25 (19.1 x 6.4) | 115 | 10,000 |
| PDL-275 | | Silver | 0.75 x 0.25 (19.1 x 6.4) | 115 | 5000 |
| PDL-175 | | Silver | 0.81 x 0.50 (20.7 x 12.7) | 116 | 5000 |
| PDL-68 | | Silver | 0.90 x 0.25 (22.9 x 6.4) | 116 | 5000 |
| PDL-158 | | Silver | 1.00 x 0.50 (25.4 x 12.7) | 117 | 5000 |
| PDL-22-1 | | Silver | 1.00 x 0.50 (25.4 x 12.7) | 117 | 1000 |
| PDL-22 | | Silver | 1.00 x 0.50 (25.4 x 12.7) | 117 | 5000 |
| PDL-22-10 | | Silver | 1.00 x 0.50 (25.4 x 12.7) | 117 | 10,000 |
| PDL-7542-10 | | Silver | 1.50 x 0.25 (38.1 x 6.4) | 118 | 10,000 |
| PDL-29-1 | | Silver | 1.50 x 0.75 (38.1 x 19.1) | 119 | 1000 |
| PDL-29 | | Silver | 1.50 x 0.75 (38.1 x 19.1) | 119 | 5000 |
| PDL-29-10 | | Silver | 1.50 x 0.75 (38.1 x 19.1) | 119 | 10,000 |
| PDL-7572-1R | | Silver | 1.63 x 0.38 (41.3 x 9.5)• | 119 | 1000 |
| PDL-7572-10R | | Silver | 1.63 x 0.38 (41.3 x 9.5)• | 119 | 10,000 |
| PDL-7517 | | Silver | 2.00 x 0.38 (50.8 x 9.5) | 119 | 5000 |
| PDL-302 | | Silver | 2.00 x 0.90 (50.8 x 22.9) | 119 | 1000 |
| PDL-145 | | Silver | 2.00 x 1.25 (50.8 x 31.8) | 119 | 1000 |
| PDL-306 | | Silver | 2.00 x 1.44 (50.8 x 36.5) | 120 | 1000 |
| PDL-312 | | Silver | 3.00 x 0.90 (76.2 x 22.9) | 120 | 1000 |
| PDL-316 | | Silver | 3.00 x 1.44 (76.2 x 36.5) | 120 | 1000 |
| PDL-320 | | Silver | 3.00 x 1.90 (76.2 x 48.3) | 120 | 1000 |
| PDL-139 | | Silver | 3.00 x 2.00 (76.2 x 50.8) | 120 | 1000 |
| PDL-151 | | Silver | 3.25 x 1.25 (82.6 x 31.8) | 120 | 1000 |
| PDL-328 | | Silver | 3.90 x 1.44 (99.1 x 36.5) | 121 | 1000 |

• Indicates label is roll mounted

TIA/EIA-606 Compliant Network Systems Labeling



What is TIA/EIA-606?

TIA/EIA-606 is a standard from the Telecommunications Industry Association which requires labeling and administration of the telecommunication infrastructure in commercial buildings. TIA-606 applies to Cables, Connectors, Hub Facilities, Termination Facilities (Patch Panels), Conduits and Pathways.

Panduit manufactures a broad range of labeling products to help you conform to TIA/EIA-606.

Along with the labels already shown in this section, the following pages feature labels designed specifically for Network Systems Labeling. Many of these labels can be used with Dot-Matrix and Laser Printers.

*For more information on the complete line of **PAN-NET™** Network Cabling System Products, ask for the Communication Products Catalog.*

Cable Labeling



Color Coded Self-Laminating Labels

- Labels have colored strip on left side to provide 360° color coding
- White Print-On area is highly legible
- Clear overlaminates protects legend
- Available in 2 materials and 8 colors

GMV3 Self-Laminating Vinyl Labels - Indoor Applications

| Part Number | Material | Print-On Area Color | Label Size Width x Length In. (mm) | Print-On Area Width x Length In. (mm) | Nominal Cable Outside Diameter * In. (mm) | Dwg. Page No. | Std. Pkg. Qty.* |
|-------------|----------------------------|-------------------------------|------------------------------------|---------------------------------------|---|---------------|-----------------|
| PDL-1B† | GMV3 Self-Laminating Vinyl | White with Blue Strip on Left | 0.50 x 1.44 (12.7 x 36.5) | 0.50 x 0.50 (12.7 x 12.7) | 0.16 - 0.30 (4.0 - 7.6) | 106 | 5000 |
| PDL-8B† | | | 0.80 x 1.44 (20.3 x 36.5) | 0.80 x 0.50 (20.3 x 12.7) | 0.16 - 0.30 (4.0 - 7.6) | 106 | 5000 |
| PDL-2B† | | | 1.00 x 1.44 (25.4 x 36.5) | 1.00 x 0.50 (25.4 x 12.7) | 0.16 - 0.30 (4.0 - 7.6) | 108 | 5000 |
| PDL-4B† | | | 1.00 x 2.44 (25.4 x 61.9) | 1.00 x 0.75 (25.4 x 19.1) | 0.24 - 0.54 (6.1 - 13.7) | 108 | 1000 |
| PDL-6B† | | | 1.00 x 3.94 (25.4 x 100.1) | 1.00 x 1.00 (25.4 x 25.4) | 0.32 - 0.94 (8.1 - 23.8) | 109 | 1000 |
| PDL-3B† | | | 2.00 x 1.44 (50.8 x 36.5) | 2.00 x 0.50 (50.8 x 12.7) | 0.16 - 0.30 (4.0 - 7.6) | 110 | 5000 |
| PDL-5B† | | | 2.00 x 2.44 (50.8 x 61.9) | 2.00 x 0.75 (50.8 x 19.1) | 0.24 - 0.54 (6.1 - 13.7) | 110 | 1000 |
| PDL-7B†† | | | 2.00 x 3.94 (50.8 x 100.1) | 2.00 x 1.00 (50.8 x 25.4) | 0.32 - 0.94 (8.1 - 23.8) | 111 | 1000 |

*Refer to Wire Size Selection Guide on page 196 to review diameters of commonly used cables

†Other colors available. To order, replace B with BR for Brown, G for Green, GR for Gray, OR for Orange, PR for Purple, R for Red, Y for Yellow.

††Other colors available. To order, replace B with G for Green, R for Red, Y for Yellow.

GMT1 Self-Laminating TEDLAR ^ Labels - Indoor/Outdoor and High Temperature Applications

| Part Number | Material | Print-On Area Color | Label Size Width x Length In. (mm) | Print-On Area Width x Length In. (mm) | Nominal Cable Outside Diameter * In. (mm) | Dwg. Page No. | Std. Pkg. Qty.* |
|-------------|-------------------------------|-------------------------------|------------------------------------|---------------------------------------|---|---------------|-----------------|
| PDL-53B† | GMT1 Self-Laminating TEDLAR ^ | White with Blue Strip on Left | 0.50 x 1.38 (12.7 x 34.9) | 0.50 x 0.50 (12.7 x 12.7) | 0.16 - 0.28 (4.0 - 7.1) | 106 | 5000 |
| PDL-60B† | | | 0.80 x 1.44 (20.3 x 36.5) | 0.80 x 0.50 (20.3 x 12.7) | 0.16 - 0.30 (4.0 - 7.6) | 107 | 5000 |
| PDL-54B† | | | 1.00 x 1.38 (25.4 x 34.9) | 1.00 x 0.50 (25.4 x 12.7) | 0.16 - 0.28 (4.0 - 7.1) | 108 | 5000 |
| PDL-56B† | | | 1.00 x 2.44 (25.4 x 61.9) | 1.00 x 0.75 (25.4 x 19.1) | 0.24 - 0.54 (6.1 - 13.7) | 108 | 1000 |
| PDL-58B† | | | 1.00 x 3.87 (25.4 x 98.3) | 1.00 x 1.00 (25.4 x 25.4) | 0.32 - 0.91 (8.1 - 23.2) | 109 | 1000 |
| PDL-55B† | | | 2.00 x 1.38 (50.8 x 34.9) | 2.00 x 0.50 (50.8 x 12.7) | 0.16 - 0.28 (4.0 - 7.1) | 110 | 5000 |
| PDL-57B† | | | 2.00 x 2.44 (50.8 x 61.9) | 2.00 x 0.75 (50.8 x 19.1) | 0.24 - 0.54 (6.1 - 13.7) | 110 | 1000 |
| PDL-59B† | | | 2.00 x 3.87 (50.8 x 98.3) | 2.00 x 1.00 (50.8 x 25.4) | 0.32 - 0.91 (8.1 - 23.2) | 111 | 1000 |

*Refer to Wire Size Selection Guide on page 196 to review diameters of commonly used cables

†Other colors available. To order, replace B with BR for Brown, G for Green, GR for Gray, OR for Orange, PR for Purple, R for Red, Y for Yellow.

^TEDLAR is the registered trademark of E. I. DuPont Co.

Network Systems Labels — Termination Hardware

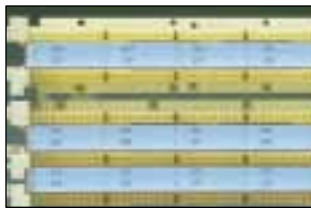

Adhesive Labels

- Eliminate the need for standard paper designation strips
- Labels are placed on top of label holders

Adhesive 110 Punch Down Block Labels

| Part Number | Material | Color | Label Width In. (mm) | Label Length In. (mm) | Vertical Repeat In. (mm) | Labels Per Row | Labels Per Roll | Web Width In. (mm) | Std. Pkg. Qty.* |
|-------------|-----------------|--------|----------------------|-----------------------|--------------------------|----------------|-----------------|--------------------|-----------------|
| PDL-403-1 | GMY-W Polyester | White | 7.50 (190.5) | 0.50 (12.7) | 0.50 (12.7) | 1 | 1000• | 8.50 (215.9) | 1000 |
| PDL-403-1B | | Blue | 7.50 (190.5) | 0.50 (12.7) | 0.50 (12.7) | 1 | 1000• | 8.50 (215.9) | 1000 |
| PDL-403-1BR | | Brown | 7.50 (190.5) | 0.50 (12.7) | 0.50 (12.7) | 1 | 1000• | 8.50 (215.9) | 1000 |
| PDL-403-1G | | Green | 7.50 (190.5) | 0.50 (12.7) | 0.50 (12.7) | 1 | 1000• | 8.50 (215.9) | 1000 |
| PDL-403-1GR | | Gray | 7.50 (190.5) | 0.50 (12.7) | 0.50 (12.7) | 1 | 1000• | 8.50 (215.9) | 1000 |
| PDL-403-1OR | | Orange | 7.50 (190.5) | 0.50 (12.7) | 0.50 (12.7) | 1 | 1000• | 8.50 (215.9) | 1000 |
| PDL-403-1PR | | Purple | 7.50 (190.5) | 0.50 (12.7) | 0.50 (12.7) | 1 | 1000• | 8.50 (215.9) | 1000 |
| PDL-403-1R | | Red | 7.50 (190.5) | 0.50 (12.7) | 0.50 (12.7) | 1 | 1000• | 8.50 (215.9) | 1000 |
| PDL-403-1Y | | Yellow | 7.50 (190.5) | 0.50 (12.7) | 0.50 (12.7) | 1 | 1000• | 8.50 (215.9) | 1000 |
| PDL-403-2.5 | | | White | 7.50 (190.5) | 0.50 (12.7) | 0.50 (12.7) | 1 | 2500• | 8.50 (215.9) |
| PDL-404-1 | GMY-C Polyester | Clear | 7.50 (190.5) | 0.50 (12.7) | 0.50 (12.7) | 1 | 1000• | 8.50 (215.9) | 1000 |
| PDL-404-2.5 | | Clear | 7.50 (190.5) | 0.50 (12.7) | 0.50 (12.7) | 1 | 2500• | 8.50 (215.9) | 2500 |

•Indicates label is supplied on rolls



Non-Adhesive Labels

- Can be used in Dot-Matrix and Laser Printers

Non-Adhesive 110 Punch Down Block Labels

| Part Number | Material | Color | Label Width In. (mm) | Label Length In. (mm) | Vertical Repeat In. (mm) | Labels Per Row | Rows Per Fanfold | Web Width In. (mm) | Std. Pkg. Qty.* |
|-------------|------------------|--------|----------------------|-----------------------|--------------------------|----------------|------------------|--------------------|-----------------|
| DS110 | Semi-Rigid Paper | White | 7.95 (200.0) | 0.50 (12.7) | 0.50 (12.7) | 1 | 15 | 8.50 (215.9) | 150 |
| DS110-BR | | Brown | 7.95 (200.0) | 0.50 (12.7) | 0.50 (12.7) | 1 | 15 | 8.50 (215.9) | 150 |
| DS110-BU | | Blue | 7.95 (200.0) | 0.50 (12.7) | 0.50 (12.7) | 1 | 15 | 8.50 (215.9) | 150 |
| DS110-GR | | Green | 7.95 (200.0) | 0.50 (12.7) | 0.50 (12.7) | 1 | 15 | 8.50 (215.9) | 150 |
| DS110-IG | | Gray | 7.95 (200.0) | 0.50 (12.7) | 0.50 (12.7) | 1 | 15 | 8.50 (215.9) | 150 |
| DS110-OR | | Orange | 7.95 (200.0) | 0.50 (12.7) | 0.50 (12.7) | 1 | 15 | 8.50 (215.9) | 150 |
| DS110-RD | | Red | 7.95 (200.0) | 0.50 (12.7) | 0.50 (12.7) | 1 | 15 | 8.50 (215.9) | 150 |
| DS110-VL | | Violet | 7.95 (200.0) | 0.50 (12.7) | 0.50 (12.7) | 1 | 15 | 8.50 (215.9) | 150 |
| DS110-YL | | Yellow | 7.95 (200.0) | 0.50 (12.7) | 0.50 (12.7) | 1 | 15 | 8.50 (215.9) | 150 |

For more information on the complete **PAN-NET™** Network Cabling System Products, ask for the Communication Products Catalog.

Network Systems Labels — Termination Hardware (cont.)



Adhesive Label for Patch Panels and Modular Furniture Faceplates

- Label is perforated on black lines to be used in 2 position, 4 position, or 6 position applications
- For Dot-Matrix and Laser printers

| Part Number | Material | Color | Label Width In. (mm) | Label Length In. (mm) | Horiz. Repeat In. (mm) | Vert. Repeat In. (mm) | Labels Per Row | Rows Per Fanfold | Web Width In. (mm) | Std. Pkg. Qty.* |
|-------------|-----------------|--------|----------------------|-----------------------|------------------------|-----------------------|----------------|------------------|--------------------|-----------------|
| CPPLF-5 | GMPO Polyolefin | White | 0.61 (15.5) | 0.33 (8.4) | 0.61 (15.5) | 0.33 (8.4) | 12 | 25 | 8.50 (215.9) | 5000 |
| CPPLF-5BU | | Blue | 0.61 (15.5) | 0.33 (8.4) | 0.61 (15.5) | 0.33 (8.4) | 12 | 25 | 8.50 (215.9) | 5000 |
| CPPLF-5EI | | Ivory | 0.61 (15.5) | 0.33 (8.4) | 0.61 (15.5) | 0.33 (8.4) | 12 | 25 | 8.50 (215.9) | 5000 |
| CPPLF-5GR | | Green | 0.61 (15.5) | 0.33 (8.4) | 0.61 (15.5) | 0.33 (8.4) | 12 | 25 | 8.50 (215.9) | 5000 |
| CPPLF-5IG | | Gray | 0.61 (15.5) | 0.33 (8.4) | 0.61 (15.5) | 0.33 (8.4) | 12 | 25 | 8.50 (215.9) | 5000 |
| CPPLF-5OR | | Orange | 0.61 (15.5) | 0.33 (8.4) | 0.61 (15.5) | 0.33 (8.4) | 12 | 25 | 8.50 (215.9) | 5000 |
| CPPLF-5PR | | Purple | 0.61 (15.5) | 0.33 (8.4) | 0.61 (15.5) | 0.33 (8.4) | 12 | 25 | 8.50 (215.9) | 5000 |
| CPPLF-5RD | | Red | 0.61 (15.5) | 0.33 (8.4) | 0.61 (15.5) | 0.33 (8.4) | 12 | 25 | 8.50 (215.9) | 5000 |
| CPPLF-5YL | | Yellow | 0.61 (15.5) | 0.33 (8.4) | 0.61 (15.5) | 0.33 (8.4) | 12 | 25 | 8.50 (215.9) | 5000 |

Network Systems Labels — Termination Position



MINI-JACK™ Modular Jack and OPTI-JACK™ Fiber Optic Connector Labels

- Identify individual jacks and connectors
- Wrap around design allows for quick and secure installation
- Labels attach directly to jacks
- Labels have preprinted black fold lines to speed installation

For Dot-Matrix Printers Only

| Part Number | Material | Color | Label Width In. (mm) | Label Length In. (mm) | Horizontal Repeat In. (mm) | Vertical Repeat In. (mm) | Labels Per Row | Rows Per Fanfold | Web Width In. (mm) | Std. Pkg. Qty.* |
|-------------|-----------|--------|----------------------|-----------------------|----------------------------|--------------------------|----------------|------------------|--------------------|-----------------|
| PDL-411-1 | Polyester | Clear | 1.38 (34.9) | 0.19 (4.8) | 1.50 (38.1) | 0.50 (12.7) | 3 | 24 | 5.38 (136.5) | 1000 |
| PDL-411-1BU | | Blue | 1.38 (34.9) | 0.19 (4.8) | 1.50 (38.1) | 0.50 (12.7) | 3 | 24 | 5.38 (136.5) | 1000 |
| PDL-411-1EI | | Ivory | 1.38 (34.9) | 0.19 (4.8) | 1.50 (38.1) | 0.50 (12.7) | 3 | 24 | 5.38 (136.5) | 1000 |
| PDL-411-1GR | | Green | 1.38 (34.9) | 0.19 (4.8) | 1.50 (38.1) | 0.50 (12.7) | 3 | 24 | 5.38 (136.5) | 1000 |
| PDL-411-1IG | | Gray | 1.38 (34.9) | 0.19 (4.8) | 1.50 (38.1) | 0.50 (12.7) | 3 | 24 | 5.38 (136.5) | 1000 |
| PDL-411-1OR | | Orange | 1.38 (34.9) | 0.19 (4.8) | 1.50 (38.1) | 0.50 (12.7) | 3 | 24 | 5.38 (136.5) | 1000 |
| PDL-411-1VL | | Violet | 1.38 (34.9) | 0.19 (4.8) | 1.50 (38.1) | 0.50 (12.7) | 3 | 24 | 5.38 (136.5) | 1000 |
| PDL-411-1RD | | Red | 1.38 (34.9) | 0.19 (4.8) | 1.50 (38.1) | 0.50 (12.7) | 3 | 24 | 5.38 (136.5) | 1000 |
| PDL-411-1YL | | Yellow | 1.38 (34.9) | 0.19 (4.8) | 1.50 (38.1) | 0.50 (12.7) | 3 | 24 | 5.38 (136.5) | 1000 |
| PDL-412 | | White | 1.38 (34.9) | 0.19 (4.8) | 1.50 (38.1) | 0.50 (12.7) | 3 | 24 | 5.38 (136.5) | 1000 |

*Order number of labels required in multiples of Std. Pkg. Qty.

Network Systems Labels — Termination Position (cont.)



Faceplates Labels

- For use with **MINI-COM®** Executive and Designer Series Faceplates
- Adhesive label designed to fit on vinyl insert provided with faceplate
- Single and Double Gang versions available
- Can also be used with **MINI-COM** Surface Mount boxes

| Part Number | Faceplate Type | Material | Color | Label Width In. (mm) | Label Length In. (mm) | Horizontal Repeat In. (mm) | Vertical Repeat In. (mm) | Labels Per Row | Rows Per Fanfold | Web Width In. (mm) | Std. Pkg. Qty.* |
|--|----------------|------------------|-------------|----------------------|-----------------------|----------------------------|--------------------------|----------------|------------------|--------------------|---------------------|
| Adhesive Faceplate Labels — For Dot-Matrix Printers Only | | | | | | | | | | | |
| EFPL-1 | Single Gang | GMPO Polyolefin | White | 1.80 (45.7) | 0.38 (9.5) | 2.00 (50.8) | 0.50 (12.7) | 2 | 22 | 4.80 (121.9) | 1000 |
| EFPL-BU-1 | | | Blue | 1.80 (45.7) | 0.38 (9.5) | 2.00 (50.8) | 0.50 (12.7) | 2 | 22 | 4.80 (121.9) | 1000 |
| EFPL-EI-1 | | | Ivory | 1.80 (45.7) | 0.38 (9.5) | 2.00 (50.8) | 0.50 (12.7) | 2 | 22 | 4.80 (121.9) | 1000 |
| EFPL-GR-1 | | | Green | 1.80 (45.7) | 0.38 (9.5) | 2.00 (50.8) | 0.50 (12.7) | 2 | 22 | 4.80 (121.9) | 1000 |
| EFPL-IG-1 | | | Gray | 1.80 (45.7) | 0.38 (9.5) | 2.00 (50.8) | 0.50 (12.7) | 2 | 22 | 4.80 (121.9) | 1000 |
| EFPL-OR-1 | | | Orange | 1.80 (45.7) | 0.38 (9.5) | 2.00 (50.8) | 0.50 (12.7) | 2 | 22 | 4.80 (121.9) | 1000 |
| EFPL-RD-1 | | | Red | 1.80 (45.7) | 0.38 (9.5) | 2.00 (50.8) | 0.50 (12.7) | 2 | 22 | 4.80 (121.9) | 1000 |
| EFPL-VL-1 | | | Violet | 1.80 (45.7) | 0.38 (9.5) | 2.00 (50.8) | 0.50 (12.7) | 2 | 22 | 4.80 (121.9) | 1000 |
| EFPL-YL-1 | | | Yellow | 1.80 (45.7) | 0.38 (9.5) | 2.00 (50.8) | 0.50 (12.7) | 2 | 22 | 4.80 (121.9) | 1000 |
| EFPL10-1 | | | Double Gang | GMPO Polyolefin | White | 2.90 (73.7) | 0.30 (7.6) | — | 0.50 (12.7) | 1 | 22 |
| EFPL10-BU-1 | Blue | 2.90 (73.7) | | | 0.30 (7.6) | — | 0.50 (12.7) | 1 | 22 | 4.68 (118.9) | 1000 |
| EFPL10-EI-1 | Ivory | 2.90 (73.7) | | | 0.30 (7.6) | — | 0.50 (12.7) | 1 | 22 | 4.68 (118.9) | 1000 |
| EFPL10-GR-1 | Green | 2.90 (73.7) | | | 0.30 (7.6) | — | 0.50 (12.7) | 1 | 22 | 4.68 (118.9) | 1000 |
| EFPL10-IG-1 | Gray | 2.90 (73.7) | | | 0.30 (7.6) | — | 0.50 (12.7) | 1 | 22 | 4.68 (118.9) | 1000 |
| EFPL10-OR-1 | Orange | 2.90 (73.7) | | | 0.30 (7.6) | — | 0.50 (12.7) | 1 | 22 | 4.68 (118.9) | 1000 |
| EFPL10-RD-1 | Red | 2.90 (73.7) | | | 0.30 (7.6) | — | 0.50 (12.7) | 1 | 22 | 4.68 (118.9) | 1000 |
| EFPL10-VL-1 | Violet | 2.90 (73.7) | | | 0.30 (7.6) | — | 0.50 (12.7) | 1 | 22 | 4.68 (118.9) | 1000 |
| EFPL10-YL-1 | Yellow | 2.90 (73.7) | | | 0.30 (7.6) | — | 0.50 (12.7) | 1 | 22 | 4.68 (118.9) | 1000 |
| Non-Adhesive Faceplate Labels on Sheets — For Dot-Matrix and Laser Printers | | | | | | | | | | | |
| EFPT-1 | Single Gang | Semi-Rigid Paper | White | 1.80 (45.7) | 0.38 (9.5) | 1.80 (45.7) | 0.38 (9.5) | 4 | 19 | 8.50 (215.9) | 1000 |
| EFPT10-1 | Double Gang | | White | 2.90 (73.7) | 0.30 (7.6) | 2.90 (73.7) | 0.30 (7.6) | 2 | 24 | 8.50 (215.9) | 1000 |
| Non-Adhesive Faceplate Labels on Rolls — For Dot-Matrix Printers Only | | | | | | | | | | | |
| PDL-408-TL | Single Gang | Semi-Rigid Vinyl | White | 1.95 (49.5) | 0.40 (10.2) | — | 0.50 (12.7) | 1 | 250* | 2.95 (74.9) | 1 Roll (250 Labels) |
| PDL-410-TL | Double Gang | | White | 3.00 (76.2) | 0.33 (8.5) | — | 0.33 (8.5) | 1 | 250* | 4.00 (101.6) | 1 Roll (250 Labels) |

*Indicates label is roll mounted

*For more information on the complete **PAN-NET™** Network Cabling System Products, ask for the Communication Products Catalog.*

Machinery Materials Identification Labels



DIN A4 Sheet Format

| Part Number | Color | Material | Print-On Area Width x Length In. (mm) | Labels Per Row | Rows Per Sheet | Labels Per Sheet | Std. Pkg. Qty.* |
|---------------|---------------------------|-----------------|---------------------------------------|----------------|----------------|------------------|-----------------|
| PECWMS-1065BW | White with a black frame | GMC Vinyl Cloth | 2.56 x 0.39 (65.0 x 10.0) | 3 | 26 | 78 | 25 Sheets |
| PECWMS-1119BW | | | 0.75 x 0.43 (19.1 x 11.0) | 10 | 24 | 240 | 25 Sheets |
| PECWMS-1138BW | | | 1.50 x 0.43 (38.0 x 11.0) | 5 | 24 | 120 | 25 Sheets |
| PECWMS-1442BW | | | 1.65 x 0.55 (42.0 x 14.0) | 4 | 19 | 76 | 25 Sheets |
| PECWMS-2256BW | | | 2.20 x 0.87 (56.0 x 22.0) | 3 | 12 | 36 | 25 Sheets |
| PECWMS-820B | Yellow with a black frame | | 0.79 x 0.31 (20.0 x 8.0) | 9 | 33 | 297 | 25 Sheets |
| PECWMS-915B | | | 0.59 x 0.35 (15.0 x 9.0) | 12 | 29 | 348 | 25 Sheets |
| PECWMS-1119B | | | 0.75 x 0.43 (19.1 x 11.0) | 10 | 24 | 240 | 25 Sheets |
| PECWMS-1138B | | | 1.50 x 0.43 (38.0 x 11.0) | 5 | 24 | 120 | 25 Sheets |
| PECWMS-2256B | | | 2.20 x 0.87 (56.0 x 22.0) | 3 | 12 | 36 | 25 Sheets |
| PECWMS-3560B | Yellow with no frame | | 2.36 x 1.38 (60.0 x 35.0) | 3 | 8 | 24 | 25 Sheets |
| PECWMS-820 | | | 0.79 x 0.31 (20.0 x 8.0) | 9 | 33 | 297 | 25 Sheets |
| PECWMS-915 | | | 0.59 x 0.35 (15.0 x 9.0) | 12 | 29 | 348 | 25 Sheets |
| PECWMS-1119 | | | 0.75 x 0.43 (19.1 x 11.0) | 10 | 24 | 240 | 25 Sheets |
| PECWMS-1138 | | | 1.50 x 0.43 (38.0 x 11.0) | 5 | 24 | 120 | 25 Sheets |

*Order number of sheets required in multiples of Std. Pkg. Qty.

- GMC Vinyl Cloth with adhesive that can be removed without leaving any adhesive residue
- Available in two formats

DIN A4 Sheet Format

- For Lettering with Panduit Marking Pens (see below), typewriter or dot-matrix printer

Pinfeed Format

- For printing with a dot-matrix printer

Pinfeed Format

| Part Number | Color | Material | Print-On Area Width x Length In. (mm) | Labels Per Row | Rows Per Fanfold | Labels Per Fanfold | Std. Pkg. Qty.* |
|-------------|----------------------|-----------------|---------------------------------------|----------------|------------------|--------------------|-----------------|
| PEDL-820 | Yellow with no frame | GMC Vinyl Cloth | 0.79 x 0.31 (20.0 x 8.0) | 9 | 24 | 216 | 5000 |
| PEDL-915 | | | 0.59 x 0.35 (15.0 x 9.0) | 12 | 24 | 288 | 5000 |
| PEDL-1119 | | | 0.75 x 0.43 (19.1 x 11.0) | 9 | 18 | 162 | 5000 |
| PEDL-1138 | | | 1.50 x 0.43 (38.0 x 11.0) | 5 | 18 | 90 | 5000 |
| PEDL-2256 | | | 2.20 x 0.87 (56.0 x 22.0) | 3 | 12 | 36 | 1000 |

*Order number of labels required in multiples of Std. Pkg. Qty.

Marking Pens



- Fast drying permanent ink

| Part Number | Color | Description | Std. Pkg. Qty.* |
|-------------|-------|--|-----------------|
| PX-0 | Black | Regular Tip Pen Reversible tip to extend life of pen. | 12 |
| PX-2 | Red | | 12 |
| PFX-0 | Black | Fine Tip Pen For detailed marking | 12 |
| PFX-2 | Red | | 12 |

*Order number of pens required in multiple of Std. Pkg. Qty.

Typewriter Sheets



- Markers are positioned for standard typewriter spacing
- White Print-On Area with clear lamination
- Available in two materials and two sheet formats

8.5" x 8.5" (215.9mm x 215.9mm) Sheet Size

| Part Number | Material | Print-On Area Width x Length In. (mm) | Total Marker Size Width x Length In. (mm) | Markers per Sheet | Nominal Cable Outside Diameter [■] In. (mm) | Std. Pkg. Qty.* |
|-------------|----------------------------|---------------------------------------|---|-------------------|--|-----------------|
| PSWMS-0515 | GMV3 Self-Laminating Vinyl | 0.50 x 0.50 (12.7 x 12.7) | 0.50 x 1.50 (12.7 x 38.1) | 64 | 0.16 - 0.32 (4.0 - 8.1) | 25 Sheets |
| PSWMS-1015 | | 1.00 x 0.50 (25.4 x 12.7) | 1.00 x 1.50 (25.4 x 38.1) | 32 | | |
| PSWMS-2015 | | 2.00 x 0.50 (50.8 x 12.7) | 2.00 x 1.50 (50.8 x 38.1) | 16 | | |
| PSWMS-1022 | | 1.00 x 0.75 (25.4 x 19.1) | 1.00 x 2.25 (25.4 x 57.1) | 24 | 0.24 - 0.48 (6.1 - 12.1) | |
| PSWMS-2022 | | 2.00 x 0.75 (50.8 x 19.1) | 2.00 x 2.25 (50.8 x 57.1) | 12 | | |
| PSWMS-1037 | | 1.00 x 1.00 (25.4 x 25.4) | 1.00 x 3.75 (25.4 x 95.2) | 16 | 0.32 - 0.87 (8.1 - 22.2) | |
| PSWMS-2037 | | 2.00 x 1.00 (50.8 x 25.4) | 2.00 x 3.75 (50.8 x 95.2) | 8 | | |

8.3" x 11.7" (210mm x 297mm) Sheet Size

| Part Number | Material | Print-On Area Width x Length In. (mm) | Total Marker Size Width x Length In. (mm) | Markers per Sheet | Nominal Cable Outside Diameter [■] In. (mm) | Std. Pkg. Qty.* |
|-------------|--|---------------------------------------|---|-------------------|--|-----------------|
| PESWMS-01 | GMVF Self-Laminating Vinyl-Free Polyolefin | 0.70 x 0.33 (17.8 x 8.5) | 0.70 x 1.33 (17.8 x 33.8) | 80 | 0.10 - 0.32 (2.7 - 8.1) | 25 Sheets |
| PESWMS-02 | | 0.90 x 0.50 (22.9 x 12.7) | 0.90 x 2.16 (22.9 x 55.0) | 40 | 0.16 - 0.53 (4.0 - 13.4) | |
| PESWMS-03 | | 1.00 x 0.66 (25.4 x 16.9) | 1.00 x 2.66 (25.4 x 67.7) | 28 | 0.21 - 0.64 (5.3 - 16.2) | |
| PESWMS-04 | | 1.20 x 0.83 (30.5 x 21.2) | 1.20 x 2.66 (30.5 x 67.7) | 24 | 0.26 - 0.58 (6.7 - 14.8) | |
| PESWMS-05 | | 1.40 x 1.00 (35.6 x 25.4) | 1.40 x 3.66 (35.6 x 93.1) | 15 | 0.32 - 0.85 (8.1 - 21.5) | |
| PESWMS-06 | | 1.40 x 1.00 (35.6 x 25.4) | 1.40 x 5.50 (35.6 x 139.7) | 10 | 0.32 - 1.43 (8.1 - 36.4) | |
| PESWMS-07 | | 1.80 x 1.16 (45.7 x 29.6) | 1.80 x 5.50 (45.7 x 139.7) | 8 | 0.37 - 1.38 (9.3 - 35.1) | |

*Order number of sheets required in multiples of Std. Pkg. Qty.

■ Refer to Wire Size Selection Guide on [page 196](#) to review diameters of commonly used cables

General Use Labels

- Highly ink receptive paper for economical printing applications

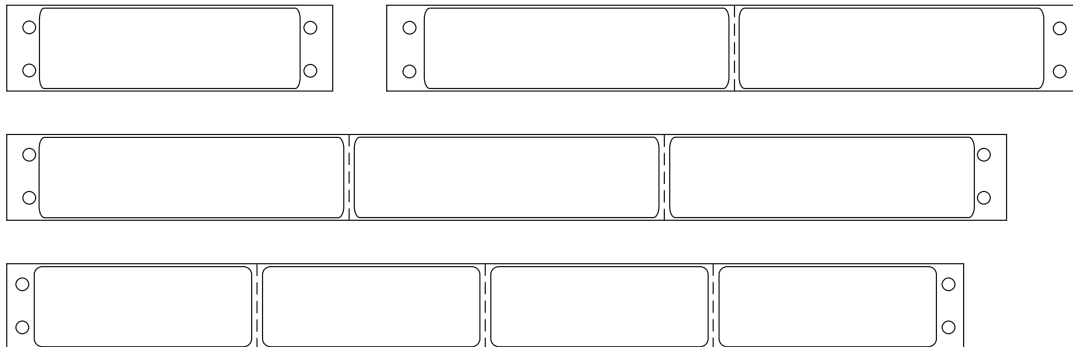

| Part Number | Material | Labels Size Width x Length In. (mm) | Labels Per Row | Web Width In. (mm) | Horizontal Sheet Perforations In. (mm) | Vertical Repeat In. (mm) | Std. Pkg. Qty.* | |
|-------------|----------------------------|-------------------------------------|----------------------------|--------------------|--|--------------------------|-----------------|--------|
| PL2515-1 | Litho Paper | 2.50 x 0.94 (63.5 x 23.8) | 1 | 3.50 (88.9) | 6.00 (152.4) | 1.00 (25.4) | 5000 | |
| PL2515-2 | | 2.50 x 0.94 (63.5 x 23.8) | 2 | 6.00 (152.4) | 6.00 (152.4) | 1.00 (25.4) | 10,000 | |
| PL2515-3 | | 2.50 x 0.94 (63.5 x 23.8) | 3 | 8.50 (215.9) | 6.00 (152.4) | 1.00 (25.4) | 15,000 | |
| PL2515-4 | | 2.50 x 0.94 (63.5 x 23.8) | 4 | 11.00 (279.4) | 6.00 (152.4) | 1.00 (25.4) | 20,000 | |
| PL2515-5 | | 2.50 x 0.94 (63.5 x 23.8) | 5 | 14.00 (355.6) | 6.00 (152.4) | 1.00 (25.4) | 2500 | |
| PL2757-1 | Litho Paper | 2.75 x 0.45 (69.9 x 11.1) | 1 | 3.50 (88.9) | 6.00 (152.4) | 0.50 (12.7) | 10,000 | |
| PL2757-4 | | 2.75 x 0.45 (69.9 x 11.1) | 4 | 12.13 (308.1) | 6.00 (152.4) | 0.50 (12.7) | 40,000 | |
| PL27515-1 | | 2.75 x 0.94 (69.9 x 23.8) | 1 | 3.50 (88.9) | 6.00 (152.4) | 1.00 (25.4) | 5000 | |
| PL27515-3 | | 2.75 x 0.94 (69.9 x 23.8) | 3 | 9.50 (241.3) | 6.00 (152.4) | 1.00 (25.4) | 15,000 | |
| PL27515-4 | | 2.75 x 0.94 (69.9 x 23.8) | 4 | 12.13 (308.1) | 6.00 (152.4) | 1.00 (25.4) | 20,000 | |
| PL27517-1 | | 2.75 x 1.44 (69.9 x 36.5) | 1 | 3.50 (88.9) | 6.00 (152.4) | 1.50 (38.1) | 5000 | |
| PL275115-1 | | 2.75 x 1.94 (69.9 x 49.2) | 1 | 3.50 (88.9) | 2.00 (50.8) | 2.00 (50.8) | 5000 | |
| PL2915-4 | Litho Paper | 2.90 x 0.94 (73.7 x 23.8) | 4 | 12.75 (323.9) | 6.00 (152.4) | 1.00 (25.4) | 20,000 | |
| PL315-1 | Litho Paper | 3.00 x 0.94 (76.2 x 23.8) | 1 | 3.75 (95.3) | 6.00 (152.4) | 1.00 (25.4) | 5000 | |
| PL315-4 | | 3.00 x 0.94 (76.2 x 23.8) | 4 | 13.00 (330.2) | 6.00 (152.4) | 1.00 (25.4) | 20,000 | |
| PL3215-4 | Litho Paper | 3.20 x 0.94 (81.3 x 23.8) | 4 | 13.00 (330.2) | 6.00 (152.4) | 1.00 (25.4) | 20,000 | |
| PL3315-4 | Litho Paper | 3.30 x 0.94 (83.82 x 23.8) | 4 | 14.25 (362.0) | 6.00 (152.4) | 1.00 (25.4) | 20,000 | |
| PL357-1 | Litho Paper | 3.50 x 0.45 (88.9 x 11.1) | 1 | 4.25 (108.0) | 6.00 (152.4) | 0.50 (12.7) | 10,000 | |
| PL357-2 | | 3.50 x 0.45 (88.9 x 11.1) | 2 | 8.00 (203.2) | 6.00 (152.4) | 0.50 (12.7) | 20,000 | |
| PL357-3 | | 3.50 x 0.45 (88.9 x 11.1) | 3 | 11.50 (292.1) | 6.00 (152.4) | 0.50 (12.7) | 30,000 | |
| PL3515-1 | | 3.50 x 0.94 (88.9 x 23.8) | 1 | 4.25 (108.0) | 6.00 (152.4) | 1.00 (25.4) | 5000 | |
| PL3515-2 | | 3.50 x 0.94 (88.9 x 23.8) | 2 | 8.00 (203.2) | 6.00 (152.4) | 1.00 (25.4) | 10,000 | |
| PL3515-3 | | 3.50 x 0.94 (88.9 x 23.8) | 3 | 11.50 (292.1) | 6.00 (152.4) | 1.00 (25.4) | 15,000 | |
| PL3515-4 | | 3.50 x 0.94 (88.9 x 23.8) | 4 | 15.25 (387.4) | 6.00 (152.4) | 1.00 (25.4) | 20,000 | |
| PL3517-1 | | 3.50 x 1.44 (88.9 x 36.5) | 1 | 4.25 (108.0) | 6.00 (152.4) | 1.50 (38.1) | 5000 | |
| PL3517-3 | | 3.50 x 1.44 (88.9 x 36.5) | 3 | 11.00 (279.4) | 6.00 (152.4) | 1.50 (38.1) | 15,000 | |
| PL35115-1 | | 3.50 x 1.94 (88.9 x 49.2) | 1 | 4.25 (108.0) | 2.00 (50.8) | 2.00 (50.8) | 5000 | |
| PL35115-3 | | 3.50 x 1.94 (88.9 x 49.2) | 3 | 11.50 (292.1) | 2.00 (50.8) | 2.00 (50.8) | 10,000 | |
| PL47-1 | | Litho Paper | 4.00 x 0.45 (101.6 x 11.1) | 1 | 4.75 (120.7) | 6.00 (152.4) | 0.50 (12.7) | 10,000 |
| PL415-1 | | | 4.00 x 0.94 (101.6 x 23.8) | 1 | 4.75 (120.7) | 6.00 (152.4) | 1.00 (25.4) | 5000 |
| PL415-2 | | | 4.00 x 0.94 (101.6 x 23.8) | 2 | 9.00 (228.6) | 6.00 (152.4) | 1.00 (25.4) | 10,000 |
| PL415-3 | 4.00 x 0.94 (101.6 x 23.8) | | 3 | 13.00 (330.2) | 6.00 (152.4) | 1.00 (25.4) | 15,000 | |
| PL417-1 | 4.00 x 1.44 (101.6 x 36.5) | | 1 | 5.00 (127.0) | 6.00 (152.4) | 1.50 (38.1) | 5000 | |
| PL417-2 | 4.00 x 1.44 (101.6 x 36.5) | | 2 | 9.00 (228.6) | 6.00 (152.4) | 1.50 (38.1) | 10,000 | |
| PL417-3 | 4.00 x 1.44 (101.6 x 36.5) | | 3 | 13.00 (330.2) | 6.00 (152.4) | 1.50 (38.1) | 15,000 | |
| PL4115-1 | 4.00 x 1.94 (101.6 x 49.2) | | 1 | 4.75 (120.7) | 2.00 (50.8) | 2.00 (50.8) | 5000 | |
| PL4115-3 | 4.00 x 1.94 (101.6 x 49.2) | | 3 | 13.00 (330.2) | 2.00 (50.8) | 2.00 (50.8) | 10,000 | |
| PL427-1 | 4.00 x 2.44 (101.6 x 61.9) | | 1 | 4.75 (120.7) | 2.50 (63.5) | 2.50 (63.5) | 5000 | |
| PL4215-1 | 4.00 x 2.94 (101.6 x 74.6) | | 1 | 4.75 (120.7) | 3.00 (76.2) | 3.00 (76.2) | 5000 | |
| PL4215-3 | 4.00 x 2.94 (101.6 x 74.6) | | 3 | 13.00 (330.2) | 3.00 (76.2) | 3.00 (76.2) | 7500 | |
| PL425215-1 | Litho Paper | | 4.25 x 2.94 (101.6 x 74.6) | 1 | 5.00 (127.0) | 3.00 (76.2) | 3.00 (76.2) | 5000 |
| PL57-1 | Litho Paper | | 5.00 x 0.45 (127.0 x 11.1) | 1 | 5.75 (146.1) | 2.50 (63.5) | 0.50 (12.7) | 10,000 |
| PL515-1 | | | 5.00 x 0.94 (127.0 x 23.8) | 1 | 5.75 (146.1) | 6.00 (152.4) | 1.00 (25.4) | 5000 |
| PL515-2 | | 5.00 x 0.94 (127.0 x 23.8) | 2 | 11.00 (279.4) | 6.00 (152.4) | 1.00 (25.4) | 10,000 | |
| PL517-1 | | 5.00 x 1.44 (127.0 x 36.5) | 1 | 5.75 (146.1) | 6.00 (152.4) | 1.50 (38.1) | 5000 | |
| PL5115-1 | | 5.00 x 1.94 (127.01 x 49.2) | 1 | 5.75 (146.1) | 2.00 (50.8) | 2.00 (50.8) | 5000 | |
| PL5215-1 | | 5.00 x 2.94 (127.0 x 74.6) | 1 | 5.75 (146.1) | 3.00 (76.2) | 3.00 (76.2) | 5000 | |
| PL5215-2 | | 5.00 x 2.94 (127.0 x 74.6) | 2 | 11.00 (279.4) | 3.00 (76.2) | 3.00 (76.2) | 5000 | |
| PL5315-1 | | 5.00 x 3.94 (127.0 x 100.0) | 1 | 5.75 (146.1) | 4.00 (101.6) | 4.00 (101.6) | 5000 | |
| PL5315-2 | | 5.00 x 3.94 (127.0 x 100.0) | 2 | 11.00 (279.4) | 4.00 (101.6) | 4.00 (101.6) | 5000 | |
| PL575215-1 | | Litho Paper | 5.75 x 2.94 (146.1 x 74.6) | 1 | 6.50 (165.1) | 3.00 (76.2) | 3.00 (76.2) | 5000 |
| PL7757-1 | Litho Paper | 7.75 x 0.45 (196.9 x 11.1) | 1 | 8.50 (215.9) | 6.00 (152.4) | 0.50 (12.7) | 10,000 | |
| PL77515-1 | | 7.75 x 0.94 (196.9 x 23.8) | 1 | 8.50 (215.9) | 6.00 (152.4) | 1.00 (25.4) | 5000 | |

*Order number of labels required in multiples of Std. Pkg. Qty.

General Use Labels (cont.)

Cheshire Spaced Labels

- Common spacing used on large printers, usually connected to a mainframe computer
- Ideal for large volume mailings
- Large vertical gap between labels



| Part Number | Material | Label Size Width x Length In. (mm) | Labels Per Row | Web Width In. (mm) | Horizontal Sheet Perforations In. (mm) | Vertical Repeat In. (mm) | Std. Pkg. Qty.* |
|-------------|-------------|------------------------------------|----------------|--------------------|--|--------------------------|-----------------|
| PL329-4 | Litho Paper | 3.20 x 0.90 (81.3 x 22.9) | 4 | 14.88 (378.0) | 12.00 (304.8) | 1.00 (25.4) | 20,000 |
| PL3278-4 | | 3.20 x 0.90 (81.3 x 22.9) | 4 | 14.88 (378.0) | 12.00 (304.8) | 1.00 (25.4) | 40,000 |

Tinted Labels



- Choose from five pastel colors
- Used to distinguish groups of literature, boxes, packaging, etc.

| Part Number | Color Tint | Material | Label Size Width x Length In. (mm) | Labels Per Row | Web Width In. (mm) | Horizontal Sheet Perforations In. (mm) | Vertical Repeat In. (mm) | Std. Pkg. Qty.* |
|-------------|------------|-------------|------------------------------------|----------------|--------------------|--|--------------------------|-----------------|
| PL3515-1TB | Blue | Litho Paper | 3.50 x 0.94 (88.9 x 23.8) | 1 | 4.25 (108.0) | 6.00 (152.4) | 1.00 (25.4) | 5000 |
| PL3515-1TG | Green | | 3.50 x 0.94 (88.9 x 23.8) | 1 | 4.25 (108.0) | 6.00 (152.4) | 1.00 (25.4) | 5000 |
| PL3515-1TP | Pink | | 3.50 x 0.94 (88.9 x 23.8) | 1 | 4.25 (108.0) | 6.00 (152.4) | 1.00 (25.4) | 5000 |
| PL3515-1TT | Tan | | 3.50 x 0.94 (88.9 x 23.8) | 1 | 4.25 (108.0) | 6.00 (152.4) | 1.00 (25.4) | 5000 |
| PL3515-1TY | Yellow | | 3.50 x 0.94 (88.9 x 23.8) | 1 | 4.25 (108.0) | 6.00 (152.4) | 1.00 (25.4) | 5000 |
| PL417-1TB | Blue | Litho Paper | 4.00 x 0.94 (101.6 x 23.8) | 1 | 4.8 (120.7) | 6.00 (152.4) | 1.00 (25.4) | 5000 |
| PL417-1TG | Green | | 4.00 x 0.94 (101.6 x 23.8) | 1 | 4.8 (120.7) | 6.00 (152.4) | 1.00 (25.4) | 5000 |
| PL417-1TP | Pink | | 4.00 x 0.94 (101.6 x 23.8) | 1 | 4.8 (120.7) | 6.00 (152.4) | 1.00 (25.4) | 5000 |
| PL417-1TT | Tan | | 4.00 x 0.94 (101.6 x 23.8) | 1 | 4.8 (120.7) | 6.00 (152.4) | 1.00 (25.4) | 5000 |
| PL417-1TY | Yellow | | 4.00 x 0.94 (101.6 x 23.8) | 1 | 4.8 (120.7) | 6.00 (152.4) | 1.00 (25.4) | 5000 |

File Folder



- Allows identifying and sorting of files by color
- Permanent adhesive

| Part Number | Color Tint | Material | Label Size Width x Length In. (mm) | Labels Per Row | Web Width In. (mm) | Horizontal Sheet Perforations In. (mm) | Vertical Repeat In. (mm) | Std. Pkg. Qty.* |
|-------------|------------|-------------|------------------------------------|----------------|--------------------|--|--------------------------|-----------------|
| PL3510-1F | White | Litho Paper | 3.50 x 0.64 (88.9 x 16.13) | 1 | 4.25 (108.0) | 6.00 (152.4) | 1.00 (25.4) | 5000 |
| PL3510-1FB | Blue | | 3.50 x 0.64 (88.9 x 16.13) | 1 | 4.25 (108.0) | 6.00 (152.4) | 1.00 (25.4) | 5000 |
| PL3510-1FBR | Brown | | 3.50 x 0.64 (88.9 x 16.13) | 1 | 4.25 (108.0) | 6.00 (152.4) | 1.00 (25.4) | 5000 |
| PL3510-1FG | Green | | 3.50 x 0.64 (88.9 x 16.13) | 1 | 4.25 (108.0) | 6.00 (152.4) | 1.00 (25.4) | 5000 |
| PL3510-1FO | Orange | | 3.50 x 0.64 (88.9 x 16.13) | 1 | 4.25 (108.0) | 6.00 (152.4) | 1.00 (25.4) | 5000 |
| PL3510-1FP | Pink | | 3.50 x 0.64 (88.9 x 16.13) | 1 | 4.25 (108.0) | 6.00 (152.4) | 1.00 (25.4) | 5000 |
| PL3510-1FPU | Purple | | 3.50 x 0.64 (88.9 x 16.13) | 1 | 4.25 (108.0) | 6.00 (152.4) | 1.00 (25.4) | 5000 |
| PL3510-1FR | Red | | 3.50 x 0.64 (88.9 x 16.13) | 1 | 4.25 (108.0) | 6.00 (152.4) | 1.00 (25.4) | 5000 |
| PL3510-1FY | Yellow | | 3.50 x 0.64 (88.9 x 16.13) | 1 | 4.25 (108.0) | 6.00 (152.4) | 1.00 (25.4) | 5000 |

General Use Labels (cont.)

Pricing Labels



- Economical labels that can be used in high volume applications. Ideal for labeling electronic components or anywhere labeling of smaller items is required
- Permanent adhesive

| Part Number | Material | Label Size Width x Length In. (mm) | Labels Per Row | Web Width In. (mm) | Horizontal Sheet Perforations In. (mm) | Vertical Repeat In. (mm) | Std. Pkg. Qty.* |
|-------------|-------------|------------------------------------|--------------------------------|--------------------|--|--------------------------|-----------------|
| PL115-12 | Litho Paper | 1.00 x 0.94 (25.4 x 23.8) | 12 (Joined by perforations) | 13.00 (330.2) | 1.00 (25.4) | 1.00 (25.4) | 48,000 |

Removable Labels



- Common size mailing with a removable adhesive
- Ideal for any application where removal of label is a factor

| Part Number | Material | Label Size Width x Length In. (mm) | Labels Per Row | Web Width In. (mm) | Horizontal Sheet Perforations In. (mm) | Vertical Repeat In. (mm) | Std. Pkg. Qty.* |
|-------------|-----------------------|------------------------------------|----------------|--------------------|--|--------------------------|-----------------|
| PL3515-1R | Removable Litho Paper | 3.50 x 0.94 (88.9 x 23.8) | 1 | 4.25 (108.0) | 6.00 (152.4) | 1.00 (25.4) | 5000 |
| PL3515-3R | | 3.50 x 0.94 (88.9 x 23.8) | 3 | 11.50 (292.1) | 6.00 (152.4) | 1.00 (25.4) | 15,000 |
| PL417-1R | | 4.00 x 0.94 (101.6 x 23.8) | 1 | 4.8 (120.7) | 6.00 (152.4) | 1.00 (25.4) | 5000 |

Tape Reel Labels

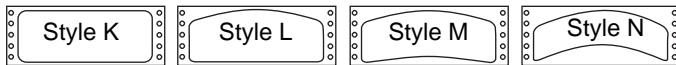

- Designed for film or video reels
- Smudge-proof surface and a removable adhesive allows reel to be reused and re-labeled

| Part Number | Material | Style | Label Size Width x Length In. (mm) | Labels Per Row | Web Width In. (mm) | Horizontal Sheet Perforations In. (mm) | Vertical Repeat In. (mm) | Std. Pkg. Qty.* |
|--------------|-------------|-------|------------------------------------|----------------|--------------------|--|--------------------------|-----------------|
| PL3515-1TRL | Litho Paper | K | 3.50 x 0.94 (88.9 x 23.8) | 1 | 4.25 (108.0) | 1.00 (25.4) | 1.00 (25.4) | 5000 |
| PL3517-1TRL | | K | 3.50 x 1.44 (88.9 x 36.5) | 1 | 4.25 (108.0) | 1.50 (38.1) | 1.50 (38.1) | 5000 |
| PL417-1TRL | | K | 4.00 x 1.44 (101.6 x 36.5) | 1 | 4.8 (120.7) | 1.50 (38.1) | 1.50 (38.1) | 5000 |
| PL3817-1TRL | | L | 3.88 x 1.44 (98.4 x 36.5) | 1 | 4.8 (120.7) | 1.50 (38.1) | 1.50 (38.1) | 5000 |
| PL38175-1TRL | | M | 3.88 x 1.75 (98.4 x 44.5) | 1 | 4.8 (120.7) | 2.00 (50.8) | 2.00 (50.8) | 5000 |
| PL4175-1TRL | | N | 4.00 x 1.75 (101.6 x 44.5) | 1 | 4.8 (120.7) | 2.00 (50.8) | 2.00 (50.8) | 5000 |

Automotive Labels

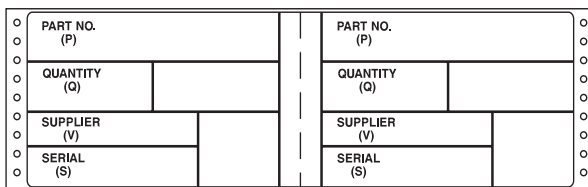

PL130315-2P Has pre-printed legend

- Sizes used to meet automotive shipping bar code requirements

| Part Number | Material | Label Size Width x Length In. (mm) | Labels Per Row | Web Width In. (mm) | Horizontal Sheet Perforations In. (mm) | Vertical Repeat In. (mm) | Std. Pkg. Qty.* |
|--------------|-------------|------------------------------------|----------------|--------------------|--|--------------------------|-----------------|
| PL130315-2 | Litho Paper | 13.00 x 3.94 (304.8 x 100.0) | Set of 2 | 14.00 (355.6) | 4.00 (101.6) | 4.00 (101.6) | 2500 |
| PL130315-2P■ | | 13.00 x 3.94 (304.8 x 100.0) | Set of 2 | 14.00 (355.6) | 4.00 (101.6) | 4.00 (101.6) | 2500 |
| PL6315-1 | | 6.00 x 3.98 (152.4 x 100.0) | 1 | 6.75 (171.5) | 4.00 (101.6) | 4.00 (101.6) | 2500 |
| PL6315-2 | | 6.00 x 3.98 (152.4 x 100.0) | 2 | 13.00 (330.2) | 14.00 (355.6) | 4.00 (101.6) | 5000 |
| PL65315-2 | | 6.00 x 3.98 (152.4 x 100.0) | 2 | 14.00 (355.6) | 4.00 (101.6) | 4.00 (101.6) | 5000 |

■ Indicates pre-printed legend

PDL Self-Laminating Labels by Size



| Part Number | Style | Material | Print-On Area Color | Label Width A In. (mm) | Label Length B In. (mm) | Print-On Length C In. (mm) | Horizontal Repeat D In. (mm) | Vertical Repeat E In. (mm) | Labels Per Row | Rows Per Fanfold | Web Width F In. (mm) | Std. Pkg. Qty.* |
|-------------|-------|------------------------|---------------------|------------------------|-------------------------|----------------------------|------------------------------|----------------------------|----------------|------------------|----------------------|-----------------|
| PDL-238 | A | SL TEDLAR [†] | White | 0.30 (7.6) | 0.75 (19.1) | 0.38 (9.5) | 0.30 (7.6) | 1.00 (25.4) | 16 | 12 | 5.80 (147.3) | 5000 |
| PDL-239 | A | SL Vinyl | White | 0.30 (7.6) | 0.75 (19.1) | 0.38 (9.5) | 0.30 (7.6) | 1.00 (25.4) | 16 | 12 | 5.80 (147.3) | 5000 |
| PDL-239VF | A | Vinyl Free SL | White | 0.30 (7.6) | 0.75 (19.1) | 0.38 (9.5) | 0.30 (7.6) | 1.00 (25.4) | 16 | 12 | 5.80 (147.3) | 5000 |
| PDL-240 | A | SL TEDLAR | White | 0.30 (7.6) | 0.94 (23.8) | 0.38 (9.5) | 0.30 (7.6) | 1.00 (25.4) | 16 | 12 | 5.80 (147.3) | 5000 |
| PDL-241 | A | SL Vinyl | White | 0.30 (7.6) | 0.94 (23.8) | 0.38 (9.5) | 0.30 (7.6) | 1.00 (25.4) | 16 | 12 | 5.80 (147.3) | 5000 |
| PDL-168 | A | SL Vinyl | White | 0.36 (9.14) | 0.94 (23.8) | 0.38 (9.5) | 0.36 (9.14) | 1.00 (25.4) | 22 | 12 | 7.94 (201.68) | 5000 |
| PDL-169 | A | SL TEDLAR | White | 0.36 (9.14) | 0.94 (23.8) | 0.38 (9.5) | 0.36 (9.14) | 1.00 (25.4) | 22 | 12 | 7.94 (201.68) | 5000 |
| PDL-42 | B | SL Vinyl | White | 0.50 (12.7) | 0.75 (19.1) | 0.38 (9.5) | 0.60 (15.2) | 1.00 (25.4) | 14 | 12 | 9.30 (236.2)‡ | 5000 |
| PDL-42-10 | B | SL Vinyl | White | 0.50 (12.7) | 0.75 (19.1) | 0.38 (9.5) | 0.60 (15.2) | 1.00 (25.4) | 14 | 12 | 9.30 (236.2)‡ | 10,000 |
| PDL-88 | B | SL TEDLAR | White | 0.50 (12.7) | 0.75 (19.1) | 0.38 (9.5) | 0.60 (15.2) | 1.00 (25.4) | 14 | 12 | 9.30 (236.2)‡ | 5000 |
| PDL-117 | B | SL Vinyl | White | 0.50 (12.7) | 0.75 (19.1) | 0.38 (9.5) | 0.60 (15.2) | 1.00 (25.4) | 12 | 12 | 8.10 (205.7) | 5000 |
| PDL-118-1 | B | SL TEDLAR | White | 0.50 (12.7) | 0.75 (19.1) | 0.38 (9.5) | 0.60 (15.2) | 1.00 (25.4) | 12 | 12 | 8.10 (205.7) | 1000 |
| PDL-118 | B | SL TEDLAR | White | 0.50 (12.7) | 0.75 (19.1) | 0.38 (9.5) | 0.60 (15.2) | 1.00 (25.4) | 12 | 12 | 8.10 (205.7) | 5000 |
| PDL-118-10 | B | SL TEDLAR | White | 0.50 (12.7) | 0.75 (19.1) | 0.38 (9.5) | 0.60 (15.2) | 1.00 (25.4) | 12 | 12 | 8.10 (205.7) | 10,000 |
| PDL-242 | A | SL TEDLAR | White | 0.50 (12.7) | 0.94 (23.8) | 0.38 (9.5) | 0.50 (12.7) | 1.00 (25.4) | 16 | 12 | 9.00 (228.6) | 5000 |
| PDL-243 | A | SL Vinyl | White | 0.50 (12.7) | 0.94 (23.8) | 0.38 (9.5) | 0.50 (12.7) | 1.00 (25.4) | 16 | 12 | 9.00 (228.6) | 5000 |
| PDL-53 | A | SL TEDLAR | White | 0.50 (12.7) | 1.38 (34.9) | 0.50 (12.7) | 0.50 (12.7) | 1.50 (38.1) | 16 | 8 | 9.00 (228.6) | 5000 |
| PDL-53B | A | SL TEDLAR | Blue/White | 0.50 (12.7) | 1.38 (34.9) | 0.50 (12.7) | 0.50 (12.7) | 1.50 (38.1) | 16 | 8 | 9.00 (228.6) | 5000 |
| PDL-53BR | A | SL TEDLAR | Brown/White | 0.50 (12.7) | 1.38 (34.9) | 0.50 (12.7) | 0.50 (12.7) | 1.50 (38.1) | 16 | 8 | 9.00 (228.6) | 5000 |
| PDL-53G | A | SL TEDLAR | Green/White | 0.50 (12.7) | 1.38 (34.9) | 0.50 (12.7) | 0.50 (12.7) | 1.50 (38.1) | 16 | 8 | 9.00 (228.6) | 5000 |
| PDL-53GR | A | SL TEDLAR | Gray/White | 0.50 (12.7) | 1.38 (34.9) | 0.50 (12.7) | 0.50 (12.7) | 1.50 (38.1) | 16 | 8 | 9.00 (228.6) | 5000 |
| PDL-53OR | A | SL TEDLAR | Orange/White | 0.50 (12.7) | 1.38 (34.9) | 0.50 (12.7) | 0.50 (12.7) | 1.50 (38.1) | 16 | 8 | 9.00 (228.6) | 5000 |
| PDL-53PR | A | SL TEDLAR | Purple/White | 0.50 (12.7) | 1.38 (34.9) | 0.50 (12.7) | 0.50 (12.7) | 1.50 (38.1) | 16 | 8 | 9.00 (228.6) | 5000 |
| PDL-53R | A | SL TEDLAR | Red/White | 0.50 (12.7) | 1.38 (34.9) | 0.50 (12.7) | 0.50 (12.7) | 1.50 (38.1) | 16 | 8 | 9.00 (228.6) | 5000 |
| PDL-53Y | A | SL TEDLAR | Yellow/White | 0.50 (12.7) | 1.38 (34.9) | 0.50 (12.7) | 0.50 (12.7) | 1.50 (38.1) | 16 | 8 | 9.00 (228.6) | 5000 |
| PDL-53-10 | A | SL TEDLAR | White | 0.50 (12.7) | 1.38 (34.9) | 0.50 (12.7) | 0.50 (12.7) | 1.50 (38.1) | 16 | 8 | 9.00 (228.6) | 10,000 |
| PDL-1-1 | A | SL Vinyl | White | 0.50 (12.7) | 1.44 (36.5) | 0.50 (12.7) | 0.50 (12.7) | 1.50 (38.1) | 16 | 8 | 9.00 (228.6) | 1000 |
| PDL-1 | A | SL Vinyl | White | 0.50 (12.7) | 1.44 (36.5) | 0.50 (12.7) | 0.50 (12.7) | 1.50 (38.1) | 16 | 8 | 9.00 (228.6) | 5000 |
| PDL-1B | A | SL Vinyl | Blue/White | 0.50 (12.7) | 1.44 (36.5) | 0.50 (12.7) | 0.50 (12.7) | 1.50 (38.1) | 16 | 8 | 9.00 (228.6) | 5000 |
| PDL-1BR | A | SL Vinyl | Brown/White | 0.50 (12.7) | 1.44 (36.5) | 0.50 (12.7) | 0.50 (12.7) | 1.50 (38.1) | 16 | 8 | 9.00 (228.6) | 5000 |
| PDL-1G | A | SL Vinyl | Green/White | 0.50 (12.7) | 1.44 (36.5) | 0.50 (12.7) | 0.50 (12.7) | 1.50 (38.1) | 16 | 8 | 9.00 (228.6) | 5000 |
| PDL-1GR | A | SL Vinyl | Gray/White | 0.50 (12.7) | 1.44 (36.5) | 0.50 (12.7) | 0.50 (12.7) | 1.50 (38.1) | 16 | 8 | 9.00 (228.6) | 5000 |
| PDL-1OR | A | SL Vinyl | Orange/White | 0.50 (12.7) | 1.44 (36.5) | 0.50 (12.7) | 0.50 (12.7) | 1.50 (38.1) | 16 | 8 | 9.00 (228.6) | 5000 |
| PDL-1PR | A | SL Vinyl | Purple/White | 0.50 (12.7) | 1.44 (36.5) | 0.50 (12.7) | 0.50 (12.7) | 1.50 (38.1) | 16 | 8 | 9.00 (228.6) | 5000 |
| PDL-1R | A | SL Vinyl | Red/White | 0.50 (12.7) | 1.44 (36.5) | 0.50 (12.7) | 0.50 (12.7) | 1.50 (38.1) | 16 | 8 | 9.00 (228.6) | 5000 |
| PDL-1VF | A | Vinyl Free SL | White | 0.50 (12.7) | 1.44 (36.5) | 0.50 (12.7) | 0.50 (12.7) | 1.50 (38.1) | 16 | 8 | 9.00 (228.6) | 5000 |
| PDL-1Y | A | SL Vinyl | Yellow/White | 0.50 (12.7) | 1.44 (36.5) | 0.50 (12.7) | 0.50 (12.7) | 1.50 (38.1) | 16 | 8 | 9.00 (228.6) | 5000 |
| PDL-1-10 | A | SL Vinyl | White | 0.50 (12.7) | 1.44 (36.5) | 0.50 (12.7) | 0.50 (12.7) | 1.50 (38.1) | 16 | 8 | 9.00 (228.6) | 10,000 |
| PDL-12 | B | SL Vinyl | White | 0.50 (12.7) | 1.44 (36.5) | 0.50 (12.7) | 0.60 (15.2) | 1.50 (38.1) | 12 | 8 | 8.10 (205.7) | 5000 |
| PDL-61 | B | SL TEDLAR | White | 0.50 (12.7) | 1.44 (36.5) | 0.50 (12.7) | 0.60 (15.2) | 1.50 (38.1) | 12 | 8 | 8.10 (205.7) | 5000 |
| PDL-6556-2 | B | SL Vinyl | White | 0.60 (15.2) | 1.44 (36.5) | 0.50 (12.7) | 0.70 (17.8) | 1.50 (38.1) | 12 | 8 | 9.30 (236.2)‡ | 5000 |

[†]TEDLAR is the registered trademark of E. I. DuPont Co.
[‡]Wide carriage printer required to print this label
 *Order number of labels required in multiples of Std. Pkg. Qty.

PDL Self-Laminating Labels by Size (cont.)

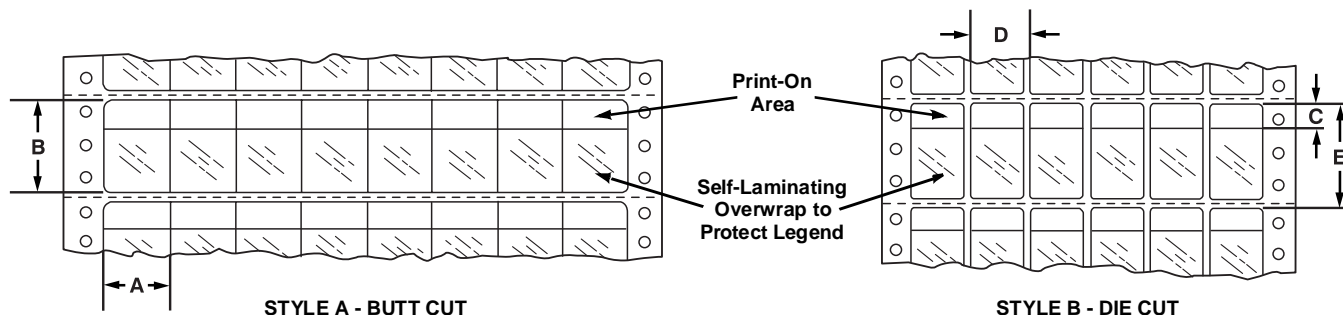

| Part Number | Style | Material | Print-On Area Color | Label Width A In. (mm) | Label Length B In. (mm) | Print-On Length C In. (mm) | Horizontal Repeat D In. (mm) | Vertical Repeat E In. (mm) | Labels Per Row | Rows Per Fanfold | Web Width F In. (mm) | Std. Pkg. Qty.* |
|-------------|-------|---------------|---------------------|---------------------------|----------------------------|-------------------------------|---------------------------------|-------------------------------|----------------|------------------|-------------------------|-----------------|
| PDL-244 | B | SL TEDLAR ^ | White | 0.75 (19.1) | 1.75 (44.5) | 0.50 (12.7) | 0.90 (22.9) | 2.00 (50.8) | 9 | 6 | 9.00 (228.6) | 5000 |
| PDL-245-1 | B | SL Vinyl | White | 0.75 (19.1) | 1.75 (44.5) | 0.50 (12.7) | 0.90 (22.9) | 2.00 (50.8) | 9 | 6 | 9.00 (228.6) | 1000 |
| PDL-245 | B | SL Vinyl | White | 0.75 (19.1) | 1.75 (44.5) | 0.50 (12.7) | 0.90 (22.9) | 2.00 (50.8) | 9 | 6 | 9.00 (228.6) | 5000 |
| PDL-245-10 | B | SL Vinyl | White | 0.75 (19.1) | 1.75 (44.5) | 0.50 (12.7) | 0.90 (22.9) | 2.00 (50.8) | 9 | 6 | 9.00 (228.6) | 10,000 |
| PDL-246 | A | SL TEDLAR | White | 0.80 (20.3) | 0.94 (23.8) | 0.38 (9.5) | 0.80 (20.3) | 1.00 (25.4) | 10 | 12 | 9.00 (228.6) | 5000 |
| PDL-247 | A | SL Vinyl | White | 0.80 (20.3) | 0.94 (23.8) | 0.38 (9.5) | 0.80 (20.3) | 1.00 (25.4) | 10 | 12 | 9.00 (228.6) | 5000 |
| PDL-8-1 | B | SL Vinyl | White | 0.80 (20.3) | 1.44 (36.5) | 0.50 (12.7) | 0.90 (22.9) | 1.50 (38.1) | 6 | 8 | 6.30 (160.0) | 1000 |
| PDL-8 | B | SL Vinyl | White | 0.80 (20.3) | 1.44 (36.5) | 0.50 (12.7) | 0.90 (22.9) | 1.50 (38.1) | 6 | 8 | 6.30 (160.0) | 5000 |
| PDL-8B | B | SL Vinyl | Blue/White | 0.80 (20.3) | 1.44 (36.5) | 0.50 (12.7) | 0.90 (22.9) | 1.50 (38.1) | 6 | 8 | 6.30 (160.0) | 5000 |
| PDL-8BR | B | SL Vinyl | Brown/White | 0.80 (20.3) | 1.44 (36.5) | 0.50 (12.7) | 0.90 (22.9) | 1.50 (38.1) | 6 | 8 | 6.30 (160.0) | 5000 |
| PDL-8G | B | SL Vinyl | Green/White | 0.80 (20.3) | 1.44 (36.5) | 0.50 (12.7) | 0.90 (22.9) | 1.50 (38.1) | 6 | 8 | 6.30 (160.0) | 5000 |
| PDL-8GR | B | SL Vinyl | Gray/White | 0.80 (20.3) | 1.44 (36.5) | 0.50 (12.7) | 0.90 (22.9) | 1.50 (38.1) | 6 | 8 | 6.30 (160.0) | 5000 |
| PDL-8OR | B | SL Vinyl | Orange/White | 0.80 (20.3) | 1.44 (36.5) | 0.50 (12.7) | 0.90 (22.9) | 1.50 (38.1) | 6 | 8 | 6.30 (160.0) | 5000 |
| PDL-8PR | B | SL Vinyl | Purple/White | 0.80 (20.3) | 1.44 (36.5) | 0.50 (12.7) | 0.90 (22.9) | 1.50 (38.1) | 6 | 8 | 6.30 (160.0) | 5000 |
| PDL-8R | B | SL Vinyl | Red/White | 0.80 (20.3) | 1.44 (36.5) | 0.50 (12.7) | 0.90 (22.9) | 1.50 (38.1) | 6 | 8 | 6.30 (160.0) | 5000 |
| PDL-8VF | B | Vinyl Free SL | White | 0.80 (20.3) | 1.44 (36.5) | 0.50 (12.7) | 0.90 (22.9) | 1.50 (38.1) | 6 | 8 | 6.30 (160.0) | 5000 |
| PDL-8Y | B | SL Vinyl | Yellow/White | 0.80 (20.3) | 1.44 (36.5) | 0.50 (12.7) | 0.90 (22.9) | 1.50 (38.1) | 6 | 8 | 6.30 (160.0) | 5000 |
| PDL-8-10 | B | SL Vinyl | White | 0.80 (20.3) | 1.44 (36.5) | 0.50 (12.7) | 0.90 (22.9) | 1.50 (38.1) | 6 | 8 | 6.30 (160.0) | 10,000 |
| PDL-60 | B | SL TEDLAR | White | 0.80 (20.3) | 1.44 (36.5) | 0.50 (12.7) | 0.90 (22.9) | 1.50 (38.1) | 6 | 8 | 6.30 (160.0) | 5000 |
| PDL-60B | B | SL TEDLAR | Blue/White | 0.80 (20.3) | 1.44 (36.5) | 0.50 (12.7) | 0.90 (22.9) | 1.50 (38.1) | 6 | 8 | 6.30 (160.0) | 5000 |
| PDL-60BR | B | SL TEDLAR | Brown/White | 0.80 (20.3) | 1.44 (36.5) | 0.50 (12.7) | 0.90 (22.9) | 1.50 (38.1) | 6 | 8 | 6.30 (160.0) | 5000 |
| PDL-60G | B | SL TEDLAR | Green/White | 0.80 (20.3) | 1.44 (36.5) | 0.50 (12.7) | 0.90 (22.9) | 1.50 (38.1) | 6 | 8 | 6.30 (160.0) | 5000 |
| PDL-60GR | B | SL TEDLAR | Gray/White | 0.80 (20.3) | 1.44 (36.5) | 0.50 (12.7) | 0.90 (22.9) | 1.50 (38.1) | 6 | 8 | 6.30 (160.0) | 5000 |
| PDL-60OR | B | SL TEDLAR | Orange/White | 0.80 (20.3) | 1.44 (36.5) | 0.50 (12.7) | 0.90 (22.9) | 1.50 (38.1) | 6 | 8 | 6.30 (160.0) | 5000 |
| PDL-60PR | B | SL TEDLAR | Purple/White | 0.80 (20.3) | 1.44 (36.5) | 0.50 (12.7) | 0.90 (22.9) | 1.50 (38.1) | 6 | 8 | 6.30 (160.0) | 5000 |
| PDL-60R | B | SL TEDLAR | Red/White | 0.80 (20.3) | 1.44 (36.5) | 0.50 (12.7) | 0.90 (22.9) | 1.50 (38.1) | 6 | 8 | 6.30 (160.0) | 5000 |
| PDL-60Y | B | SL TEDLAR | Yellow/White | 0.80 (20.3) | 1.44 (36.5) | 0.50 (12.7) | 0.90 (22.9) | 1.50 (38.1) | 6 | 8 | 6.30 (160.0) | 5000 |
| PDL-5859-2 | A | SL Vinyl | White | 0.82 (20.8) | 2.00 (50.8) | 0.63 (15.9) | 0.82 (20.8) | 2.13 (54.0) | 11 | 4 | 10.50 (266.7)‡ | 5000 |
| PDL-5859-4 | A | SL Vinyl | Yellow | 0.82 (20.8) | 2.00 (50.8) | 0.63 (15.9) | 0.82 (20.8) | 2.13 (54.0) | 11 | 4 | 10.50 (266.7)‡ | 5000 |
| PDL-248 | A | SL TEDLAR | White | 1.00 (25.4) | 0.75 (19.1) | 0.38 (9.5) | 1.00 (25.4) | 1.00 (25.4) | 8 | 12 | 9.00 (228.6) | 5000 |
| PDL-249-1 | A | SL Vinyl | White | 1.00 (25.4) | 0.75 (19.1) | 0.38 (9.5) | 1.00 (25.4) | 1.00 (25.4) | 8 | 12 | 9.00 (228.6) | 1000 |
| PDL-249 | A | SL Vinyl | White | 1.00 (25.4) | 0.75 (19.1) | 0.38 (9.5) | 1.00 (25.4) | 1.00 (25.4) | 8 | 12 | 9.00 (228.6) | 5000 |
| PDL-249VF | A | Vinyl Free SL | White | 1.00 (25.4) | 0.75 (19.1) | 0.38 (9.5) | 1.00 (25.4) | 1.00 (25.4) | 8 | 12 | 9.00 (228.6) | 5000 |
| PDL-249-10 | A | SL Vinyl | White | 1.00 (25.4) | 0.75 (19.1) | 0.38 (9.5) | 1.00 (25.4) | 1.00 (25.4) | 8 | 12 | 9.00 (228.6) | 10,000 |
| PDL-250 | A | SL TEDLAR | White | 1.00 (25.4) | 0.94 (23.8) | 0.38 (9.5) | 1.00 (25.4) | 1.00 (25.4) | 8 | 12 | 9.00 (228.6) | 5000 |
| PDL-251 | A | SL Vinyl | White | 1.00 (25.4) | 0.94 (23.8) | 0.38 (9.5) | 1.00 (25.4) | 1.00 (25.4) | 8 | 12 | 9.00 (228.6) | 5000 |

^TEDLAR is the registered trademark of E. I. DuPont Co.
 ‡Wide carriage printer required to print this label
 *Order number of labels required in multiples of Std. Pkg. Qty.

PDL Self-Laminating Labels by Size (cont.)



| Part Number | Style | Material | Print-On Area Color | Label Width A In. (mm) | Label Length B In. (mm) | Print-On Length C In. (mm) | Horizontal Repeat D In. (mm) | Vertical Repeat E In. (mm) | Labels Per Row | Rows Per Fanfold | Web Width F In. (mm) | Std. Pkg. Qty.* |
|-------------|-------|---------------|---------------------|---------------------------|----------------------------|-------------------------------|---------------------------------|-------------------------------|----------------|------------------|-------------------------|-----------------|
| PDL-54 | A | SL TEDLAR ^ | White | 1.00 (25.4) | 1.38 (34.9) | 0.50 (12.7) | 1.00 (25.4) | 1.50 (38.1) | 8 | 8 | 9.00 (228.6) | 5000 |
| PDL-54B | A | SL TEDLAR | Blue/White | 1.00 (25.4) | 1.38 (34.9) | 0.50 (12.7) | 1.00 (25.4) | 1.50 (38.1) | 8 | 8 | 9.00 (228.6) | 5000 |
| PDL-54BR | A | SL TEDLAR | Brown/White | 1.00 (25.4) | 1.38 (34.9) | 0.50 (12.7) | 1.00 (25.4) | 1.50 (38.1) | 8 | 8 | 9.00 (228.6) | 5000 |
| PDL-54G | A | SL TEDLAR | Green/White | 1.00 (25.4) | 1.38 (34.9) | 0.50 (12.7) | 1.00 (25.4) | 1.50 (38.1) | 8 | 8 | 9.00 (228.6) | 5000 |
| PDL-54GR | A | SL TEDLAR | Gray/White | 1.00 (25.4) | 1.38 (34.9) | 0.50 (12.7) | 1.00 (25.4) | 1.50 (38.1) | 8 | 8 | 9.00 (228.6) | 5000 |
| PDL-54OR | A | SL TEDLAR | Orange/White | 1.00 (25.4) | 1.38 (34.9) | 0.50 (12.7) | 1.00 (25.4) | 1.50 (38.1) | 8 | 8 | 9.00 (228.6) | 5000 |
| PDL-54PR | A | SL TEDLAR | Purple/White | 1.00 (25.4) | 1.38 (34.9) | 0.50 (12.7) | 1.00 (25.4) | 1.50 (38.1) | 8 | 8 | 9.00 (228.6) | 5000 |
| PDL-54R | A | SL TEDLAR | Red/White | 1.00 (25.4) | 1.38 (34.9) | 0.50 (12.7) | 1.00 (25.4) | 1.50 (38.1) | 8 | 8 | 9.00 (228.6) | 5000 |
| PDL-54Y | A | SL TEDLAR | Yellow/White | 1.00 (25.4) | 1.38 (34.9) | 0.50 (12.7) | 1.00 (25.4) | 1.50 (38.1) | 8 | 8 | 9.00 (228.6) | 5000 |
| PDL-2-1 | A | SL Vinyl | White | 1.00 (25.4) | 1.44 (36.5) | 0.50 (12.7) | 1.00 (25.4) | 1.50 (38.1) | 8 | 8 | 9.00 (228.6) | 1000 |
| PDL-2 | A | SL Vinyl | White | 1.00 (25.4) | 1.44 (36.5) | 0.50 (12.7) | 1.00 (25.4) | 1.50 (38.1) | 8 | 8 | 9.00 (228.6) | 5000 |
| PDL-2B | A | SL Vinyl | Blue/White | 1.00 (25.4) | 1.44 (36.5) | 0.50 (12.7) | 1.00 (25.4) | 1.50 (38.1) | 8 | 8 | 9.00 (228.6) | 5000 |
| PDL-2BR | A | SL Vinyl | Brown/White | 1.00 (25.4) | 1.44 (36.5) | 0.50 (12.7) | 1.00 (25.4) | 1.50 (38.1) | 8 | 8 | 9.00 (228.6) | 5000 |
| PDL-2G | A | SL Vinyl | Green/White | 1.00 (25.4) | 1.44 (36.5) | 0.50 (12.7) | 1.00 (25.4) | 1.50 (38.1) | 8 | 8 | 9.00 (228.6) | 5000 |
| PDL-2GR | A | SL Vinyl | Gray/White | 1.00 (25.4) | 1.44 (36.5) | 0.50 (12.7) | 1.00 (25.4) | 1.50 (38.1) | 8 | 8 | 9.00 (228.6) | 5000 |
| PDL-2OR | A | SL Vinyl | Orange/White | 1.00 (25.4) | 1.44 (36.5) | 0.50 (12.7) | 1.00 (25.4) | 1.50 (38.1) | 8 | 8 | 9.00 (228.6) | 5000 |
| PDL-2PR | A | SL Vinyl | Purple/White | 1.00 (25.4) | 1.44 (36.5) | 0.50 (12.7) | 1.00 (25.4) | 1.50 (38.1) | 8 | 8 | 9.00 (228.6) | 5000 |
| PDL-2R | A | SL Vinyl | Red/White | 1.00 (25.4) | 1.44 (36.5) | 0.50 (12.7) | 1.00 (25.4) | 1.50 (38.1) | 8 | 8 | 9.00 (228.6) | 5000 |
| PDL-2VF | A | Vinyl Free SL | White | 1.00 (25.4) | 1.44 (36.5) | 0.50 (12.7) | 1.00 (25.4) | 1.50 (38.1) | 8 | 8 | 9.00 (228.6) | 5000 |
| PDL-2Y | A | SL Vinyl | Yellow/White | 1.00 (25.4) | 1.44 (36.5) | 0.50 (12.7) | 1.00 (25.4) | 1.50 (38.1) | 8 | 8 | 9.00 (228.6) | 5000 |
| PDL-2-10 | A | SL Vinyl | White | 1.00 (25.4) | 1.44 (36.5) | 0.50 (12.7) | 1.00 (25.4) | 1.50 (38.1) | 8 | 8 | 9.00 (228.6) | 10,000 |
| PDL-9025-10 | A | SL Vinyl | White | 1.00 (25.4) | 1.44 (36.5) | 0.62 (15.8) | 1.00 (25.4) | 1.50 (38.1) | 8 | 8 | 9.00 (228.6) | 10,000 |
| PDL-4 | A | SL Vinyl | White | 1.00 (25.4) | 2.44 (61.9) | 0.75 (19.1) | 1.00 (25.4) | 2.50 (63.5) | 8 | 4 | 9.00 (228.6) | 1000 |
| PDL-4B | A | SL Vinyl | Blue/White | 1.00 (25.4) | 2.44 (61.9) | 0.75 (19.1) | 1.00 (25.4) | 2.50 (63.5) | 8 | 4 | 9.00 (228.6) | 1000 |
| PDL-4BR | A | SL Vinyl | Brown/White | 1.00 (25.4) | 2.44 (61.9) | 0.75 (19.1) | 1.00 (25.4) | 2.50 (63.5) | 8 | 4 | 9.00 (228.6) | 1000 |
| PDL-4G | A | SL Vinyl | Green/White | 1.00 (25.4) | 2.44 (61.9) | 0.75 (19.1) | 1.00 (25.4) | 2.50 (63.5) | 8 | 4 | 9.00 (228.6) | 1000 |
| PDL-4GR | A | SL Vinyl | Gray/White | 1.00 (25.4) | 2.44 (61.9) | 0.75 (19.1) | 1.00 (25.4) | 2.50 (63.5) | 8 | 4 | 9.00 (228.6) | 1000 |
| PDL-4OR | A | SL Vinyl | Orange/White | 1.00 (25.4) | 2.44 (61.9) | 0.75 (19.1) | 1.00 (25.4) | 2.50 (63.5) | 8 | 4 | 9.00 (228.6) | 1000 |
| PDL-4PR | A | SL Vinyl | Purple/White | 1.00 (25.4) | 2.44 (61.9) | 0.75 (19.1) | 1.00 (25.4) | 2.50 (63.5) | 8 | 4 | 9.00 (228.6) | 1000 |
| PDL-4R | A | SL Vinyl | Red/White | 1.00 (25.4) | 2.44 (61.9) | 0.75 (19.1) | 1.00 (25.4) | 2.50 (63.5) | 8 | 4 | 9.00 (228.6) | 1000 |
| PDL-4VF | A | Vinyl Free SL | White | 1.00 (25.4) | 2.44 (61.9) | 0.75 (19.1) | 1.00 (25.4) | 2.50 (63.5) | 8 | 4 | 9.00 (228.6) | 1000 |
| PDL-4Y | A | SL Vinyl | Yellow/White | 1.00 (25.4) | 2.44 (61.9) | 0.75 (19.1) | 1.00 (25.4) | 2.50 (63.5) | 8 | 4 | 9.00 (228.6) | 1000 |
| PDL-4-10 | A | SL Vinyl | White | 1.00 (25.4) | 2.44 (61.9) | 0.75 (19.1) | 1.00 (25.4) | 2.50 (63.5) | 8 | 4 | 9.00 (228.6) | 10,000 |
| PDL-56 | A | SL TEDLAR | White | 1.00 (25.4) | 2.44 (61.9) | 0.75 (19.1) | 1.00 (25.4) | 2.50 (63.5) | 8 | 4 | 9.00 (228.6) | 1000 |
| PDL-56B | A | SL TEDLAR | Blue/White | 1.00 (25.4) | 2.44 (61.9) | 0.75 (19.1) | 1.00 (25.4) | 2.50 (63.5) | 8 | 4 | 9.00 (228.6) | 1000 |
| PDL-56BR | A | SL TEDLAR | Brown/White | 1.00 (25.4) | 2.44 (61.9) | 0.75 (19.1) | 1.00 (25.4) | 2.50 (63.5) | 8 | 4 | 9.00 (228.6) | 1000 |
| PDL-56G | A | SL TEDLAR | Green/White | 1.00 (25.4) | 2.44 (61.9) | 0.75 (19.1) | 1.00 (25.4) | 2.50 (63.5) | 8 | 4 | 9.00 (228.6) | 1000 |
| PDL-56GR | A | SL TEDLAR | Gray/White | 1.00 (25.4) | 2.44 (61.9) | 0.75 (19.1) | 1.00 (25.4) | 2.50 (63.5) | 8 | 4 | 9.00 (228.6) | 1000 |
| PDL-56OR | A | SL TEDLAR | Orange/White | 1.00 (25.4) | 2.44 (61.9) | 0.75 (19.1) | 1.00 (25.4) | 2.50 (63.5) | 8 | 4 | 9.00 (228.6) | 1000 |
| PDL-56PR | A | SL TEDLAR | Purple/White | 1.00 (25.4) | 2.44 (61.9) | 0.75 (19.1) | 1.00 (25.4) | 2.50 (63.5) | 8 | 4 | 9.00 (228.6) | 1000 |
| PDL-56R | A | SL TEDLAR | Red/White | 1.00 (25.4) | 2.44 (61.9) | 0.75 (19.1) | 1.00 (25.4) | 2.50 (63.5) | 8 | 4 | 9.00 (228.6) | 1000 |
| PDL-56Y | A | SL TEDLAR | Yellow/White | 1.00 (25.4) | 2.44 (61.9) | 0.75 (19.1) | 1.00 (25.4) | 2.50 (63.5) | 8 | 4 | 9.00 (228.6) | 1000 |

^TEDLAR is the registered trademark of E. I. DuPont Co.
*Order number of labels required in multiples of Std. Pkg. Qty.

PDL Self-Laminating Labels by Size (cont.)



| Part Number | Style | Material | Print-On Area Color | Label Width A In. (mm) | Label Length B In. (mm) | Print-On Length C In. (mm) | Horizontal Repeat D In. (mm) | Vertical Repeat E In. (mm) | Labels Per Row | Rows Per Fanfold | Web Width F In. (mm) | Std. Pkg. Qty.* |
|-------------|-------|---------------|---------------------|---------------------------|----------------------------|-------------------------------|---------------------------------|-------------------------------|----------------|------------------|-------------------------|-----------------|
| PDL-58 | A | SL TEDLAR ▲ | White | 1.00 (25.4) | 3.87 (98.3) | 1.00 (25.4) | 1.00 (25.4) | 4.00 (101.6) | 8 | 3 | 9.00 (228.6) | 1000 |
| PDL-58B | A | SL TEDLAR | Blue/White | 1.00 (25.4) | 3.87 (98.3) | 1.00 (25.4) | 1.00 (25.4) | 4.00 (101.6) | 8 | 3 | 9.00 (228.6) | 1000 |
| PDL-58BR | A | SL TEDLAR | Brown/White | 1.00 (25.4) | 3.87 (98.3) | 1.00 (25.4) | 1.00 (25.4) | 4.00 (101.6) | 8 | 3 | 9.00 (228.6) | 1000 |
| PDL-58G | A | SL TEDLAR | Green/White | 1.00 (25.4) | 3.87 (98.3) | 1.00 (25.4) | 1.00 (25.4) | 4.00 (101.6) | 8 | 3 | 9.00 (228.6) | 1000 |
| PDL-58GR | A | SL TEDLAR | Gray/White | 1.00 (25.4) | 3.87 (98.3) | 1.00 (25.4) | 1.00 (25.4) | 4.00 (101.6) | 8 | 3 | 9.00 (228.6) | 1000 |
| PDL-58OR | A | SL TEDLAR | Orange/White | 1.00 (25.4) | 3.87 (98.3) | 1.00 (25.4) | 1.00 (25.4) | 4.00 (101.6) | 8 | 3 | 9.00 (228.6) | 1000 |
| PDL-58PR | A | SL TEDLAR | Purple/White | 1.00 (25.4) | 3.87 (98.3) | 1.00 (25.4) | 1.00 (25.4) | 4.00 (101.6) | 8 | 3 | 9.00 (228.6) | 1000 |
| PDL-58R | A | SL TEDLAR | Red/White | 1.00 (25.4) | 3.87 (98.3) | 1.00 (25.4) | 1.00 (25.4) | 4.00 (101.6) | 8 | 3 | 9.00 (228.6) | 1000 |
| PDL-58Y | A | SL TEDLAR | Yellow/White | 1.00 (25.4) | 3.87 (98.3) | 1.00 (25.4) | 1.00 (25.4) | 4.00 (101.6) | 8 | 3 | 9.00 (228.6) | 1000 |
| PDL-6 | A | SL Vinyl | White | 1.00 (25.4) | 3.94 (100.1) | 1.00 (25.4) | 1.00 (25.4) | 4.00 (101.6) | 8 | 3 | 9.00 (228.6) | 1000 |
| PDL-6B | A | SL Vinyl | Blue/White | 1.00 (25.4) | 3.94 (100.1) | 1.00 (25.4) | 1.00 (25.4) | 4.00 (101.6) | 8 | 3 | 9.00 (228.6) | 1000 |
| PDL-6BR | A | SL Vinyl | Brown/White | 1.00 (25.4) | 3.94 (100.1) | 1.00 (25.4) | 1.00 (25.4) | 4.00 (101.6) | 8 | 3 | 9.00 (228.6) | 1000 |
| PDL-6G | A | SL Vinyl | Green/White | 1.00 (25.4) | 3.94 (100.1) | 1.00 (25.4) | 1.00 (25.4) | 4.00 (101.6) | 8 | 3 | 9.00 (228.6) | 1000 |
| PDL-6GR | A | SL Vinyl | Gray/White | 1.00 (25.4) | 3.94 (100.1) | 1.00 (25.4) | 1.00 (25.4) | 4.00 (101.6) | 8 | 3 | 9.00 (228.6) | 1000 |
| PDL-6OR | A | SL Vinyl | Orange/White | 1.00 (25.4) | 3.94 (100.1) | 1.00 (25.4) | 1.00 (25.4) | 4.00 (101.6) | 8 | 3 | 9.00 (228.6) | 1000 |
| PDL-6PR | A | SL Vinyl | Purple/White | 1.00 (25.4) | 3.94 (100.1) | 1.00 (25.4) | 1.00 (25.4) | 4.00 (101.6) | 8 | 3 | 9.00 (228.6) | 1000 |
| PDL-6R | A | SL Vinyl | Red/White | 1.00 (25.4) | 3.94 (100.1) | 1.00 (25.4) | 1.00 (25.4) | 4.00 (101.6) | 8 | 3 | 9.00 (228.6) | 1000 |
| PDL-6VF | A | Vinyl Free SL | White | 1.00 (25.4) | 3.94 (100.1) | 1.00 (25.4) | 1.00 (25.4) | 4.00 (101.6) | 8 | 3 | 9.00 (228.6) | 1000 |
| PDL-6Y | A | SL Vinyl | Yellow/White | 1.00 (25.4) | 3.94 (100.1) | 1.00 (25.4) | 1.00 (25.4) | 4.00 (101.6) | 8 | 3 | 9.00 (228.6) | 1000 |
| PDL-6-2.5 | A | SL Vinyl | White | 1.00 (25.4) | 3.94 (100.1) | 1.00 (25.4) | 1.00 (25.4) | 4.00 (101.6) | 8 | 3 | 9.00 (228.6) | 2500 |
| PDL-6-10 | A | SL Vinyl | White | 1.00 (25.4) | 3.94 (100.1) | 1.00 (25.4) | 1.00 (25.4) | 4.00 (101.6) | 8 | 3 | 9.00 (228.6) | 10,000 |
| PDL-51 | B | SL Vinyl | White | 1.00 (25.4) | 5.94 (150.9) | 1.50 (38.1) | 1.10 (27.9) | 6.00 (152.4) | 8 | 2 | 9.50 (241.3)‡ | 1000 |
| PDL-95 | B | SL TEDLAR | White | 1.00 (25.4) | 5.94 (150.9) | 1.50 (38.1) | 1.10 (27.9) | 6.00 (152.4) | 8 | 2 | 9.50 (241.3)‡ | 1000 |
| PDL-123 | B | SL TEDLAR | White | 1.00 (25.4) | 5.94 (150.9) | 1.50 (38.1) | 1.10 (27.9) | 6.00 (152.4) | 7 | 2 | 9.00 (228.6) | 1000 |
| PDL-124 | B | SL Vinyl | White | 1.00 (25.4) | 5.94 (150.9) | 1.50 (38.1) | 1.10 (27.9) | 6.00 (152.4) | 7 | 2 | 9.00 (228.6) | 1000 |
| PDL-124-2.5 | B | SL Vinyl | White | 1.00 (25.4) | 5.94 (150.9) | 1.50 (38.1) | 1.10 (27.9) | 6.00 (152.4) | 7 | 2 | 9.00 (228.6) | 2500 |
| PDL-124-10 | B | SL Vinyl | White | 1.00 (25.4) | 5.94 (150.9) | 1.50 (38.1) | 1.10 (27.9) | 6.00 (152.4) | 7 | 2 | 9.00 (228.6) | 10,000 |
| PDL-52 | B | SL Vinyl | White | 1.00 (25.4) | 7.44 (189.0) | 1.50 (38.1) | 1.10 (27.9) | 7.50 (190.5) | 8 | 1 | 9.00 (228.6) | 1000 |
| PDL-52-2.5 | B | SL Vinyl | White | 1.00 (25.4) | 7.44 (189.0) | 1.50 (38.1) | 1.10 (27.9) | 7.50 (190.5) | 8 | 1 | 9.00 (228.6) | 2500 |
| PDL-96 | B | SL TEDLAR | White | 1.00 (25.4) | 7.44 (189.0) | 1.50 (38.1) | 1.10 (27.9) | 7.50 (190.5) | 8 | 1 | 9.50 (241.3)‡ | 1000 |
| PDL-125 | B | SL TEDLAR | White | 1.00 (25.4) | 7.44 (189.0) | 1.50 (38.1) | 1.10 (27.9) | 7.50 (190.5) | 7 | 2 | 9.00 (228.6) | 1000 |
| PDL-126 | B | SL Vinyl | White | 1.00 (25.4) | 7.44 (189.0) | 1.50 (38.1) | 1.10 (27.9) | 7.50 (190.5) | 7 | 2 | 9.00 (228.6) | 1000 |
| PDL-126-10 | B | SL Vinyl | White | 1.00 (25.4) | 7.44 (189.0) | 1.50 (38.1) | 1.10 (27.9) | 7.50 (190.5) | 7 | 2 | 9.00 (228.6) | 10,000 |
| PDL-5859-1 | A | SL Vinyl | White | 1.13 (28.6) | 3.75 (95.3) | 1.25 (31.8) | 1.13 (28.6) | 4.00 (101.6) | 8 | 3 | 10.50 (266.7)‡ | 5000 |
| PDL-5859-3 | A | SL Vinyl | Yellow | 1.13 (28.6) | 3.75 (95.3) | 1.25 (31.8) | 1.13 (28.6) | 4.00 (101.6) | 8 | 3 | 10.50 (266.7)‡ | 5000 |
| CCS-WHT | A | SL Vinyl | White | 1.17 (29.6) | 3.00 (76.4) | 0.83 (21.1) | 1.17 (29.6) | 3.33 (84.6) | 6 | 3 | 9.50 (241.3)‡ | 5000 |
| CCS-YEL | A | SL Vinyl | Yellow | 1.17 (29.6) | 3.00 (76.4) | 0.83 (21.1) | 1.17 (29.6) | 3.33 (84.6) | 6 | 3 | 9.50 (241.3)‡ | 5000 |
| PDL-6626-10 | B | SL Vinyl | White | 1.20 (30.5) | 2.25 (57.2) | 0.60 (15.2) | 1.30 (33.0) | 2.50 (63.5) | 6 | 4 | 8.82 (224.0) | 10,000 |
| PDL-3523-1 | B | SL Vinyl | White | 1.50 (38.1) | 2.25 (57.2) | 0.50 (12.7) | 1.60 (40.6) | 2.50 (63.5) | 5 | 4 | 9.50 (241.3)‡ | 1000 |
| PDL-361-1 | B | SL Vinyl | White | 1.50 (38.1) | 3.63 (92.1) | 0.80 (20.3) | 1.60 (40.6) | 4.00 (101.6) | 5 | 3 | 9.00 (228.6) | 1000 |

▲TEDLAR is the registered trademark of E. I. DuPont Co.
 ‡Wide carriage printer required to print this label
 *Order number of labels required in multiples of Std. Pkg. Qty.

PDL Self-Laminating Labels by Size (cont.)

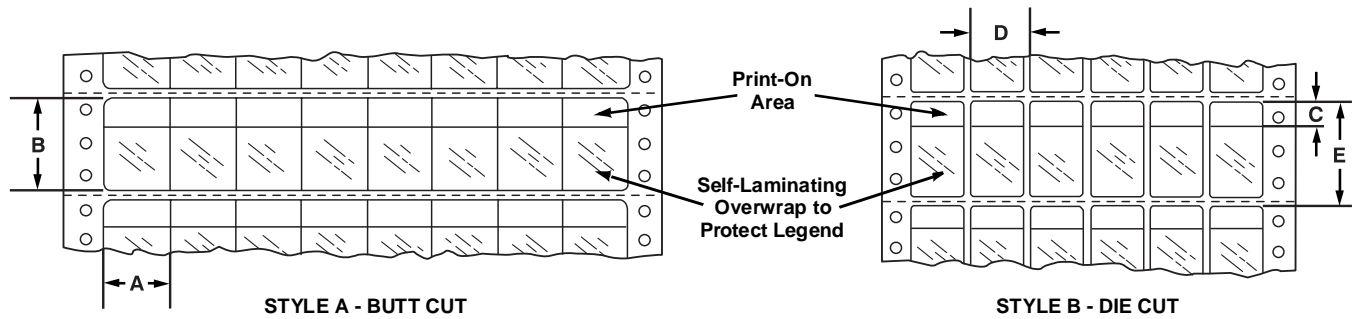

| Part Number | Style | Material | Print-On Area Color | Label Width A In. (mm) | Label Length B In. (mm) | Print-On Length C In. (mm) | Horizontal Repeat D In. (mm) | Vertical Repeat E In. (mm) | Labels Per Row | Rows Per Fanfold | Web Width F In. (mm) | Std. Pkg. Qty.* |
|-------------|-------|---------------|---------------------|---------------------------|----------------------------|-------------------------------|---------------------------------|-------------------------------|----------------|------------------|-------------------------|-----------------|
| PDL-18 | B | SL Vinyl | White | 1.90 (48.3) | 3.19 (81.0) | 0.75 (19.1) | 2.00 (50.8) | 3.50 (88.9) | 4 | 3 | 9.50 (241.3)‡ | 1000 |
| PDL-18-2.5 | B | SL Vinyl | White | 1.90 (48.3) | 3.19 (81.0) | 0.75 (19.1) | 2.00 (50.8) | 3.50 (88.9) | 4 | 3 | 9.50 (241.3)‡ | 2500 |
| PDL-18-10 | B | SL Vinyl | White | 1.90 (48.3) | 3.19 (81.0) | 0.75 (19.1) | 2.00 (50.8) | 3.50 (88.9) | 4 | 3 | 9.50 (241.3)‡ | 10,000 |
| PDL-64 | B | SL TEDLAR ▲ | White | 1.90 (48.3) | 3.19 (81.0) | 0.75 (19.1) | 2.00 (50.8) | 3.50 (88.9) | 4 | 3 | 9.50 (241.3)‡ | 1000 |
| PDL-108 | B | SL TEDLAR | White | 1.90 (48.3) | 3.19 (81.0) | 0.75 (19.1) | 2.00 (50.8) | 3.50 (88.9) | 3 | 3 | 7.50 (190.5) | 1000 |
| PDL-109 | B | SL Vinyl | White | 1.90 (48.3) | 3.19 (81.0) | 0.75 (19.1) | 2.00 (50.8) | 3.50 (88.9) | 3 | 3 | 7.50 (190.5) | 1000 |
| PDL-109-2.5 | B | SL Vinyl | White | 1.90 (48.3) | 3.19 (81.0) | 0.75 (19.1) | 2.00 (50.8) | 3.50 (88.9) | 3 | 3 | 7.50 (190.5) | 2500 |
| PDL-55 | A | SL TEDLAR | White | 2.00 (50.8) | 1.38 (34.9) | 0.50 (12.7) | 2.00 (50.8) | 1.50 (38.1) | 4 | 8 | 9.00 (228.6) | 5000 |
| PDL-55B | A | SL TEDLAR | Blue/White | 2.00 (50.8) | 1.38 (34.9) | 0.50 (12.7) | 2.00 (50.8) | 1.50 (38.1) | 4 | 8 | 9.00 (228.6) | 5000 |
| PDL-55BR | A | SL TEDLAR | Brown/White | 2.00 (50.8) | 1.38 (34.9) | 0.50 (12.7) | 2.00 (50.8) | 1.50 (38.1) | 4 | 8 | 9.00 (228.6) | 5000 |
| PDL-55G | A | SL TEDLAR | Green/White | 2.00 (50.8) | 1.38 (34.9) | 0.50 (12.7) | 2.00 (50.8) | 1.50 (38.1) | 4 | 8 | 9.00 (228.6) | 5000 |
| PDL-55GR | A | SL TEDLAR | Gray/White | 2.00 (50.8) | 1.38 (34.9) | 0.50 (12.7) | 2.00 (50.8) | 1.50 (38.1) | 4 | 8 | 9.00 (228.6) | 5000 |
| PDL-55OR | A | SL TEDLAR | Orange/White | 2.00 (50.8) | 1.38 (34.9) | 0.50 (12.7) | 2.00 (50.8) | 1.50 (38.1) | 4 | 8 | 9.00 (228.6) | 5000 |
| PDL-55PR | A | SL TEDLAR | Purple/White | 2.00 (50.8) | 1.38 (34.9) | 0.50 (12.7) | 2.00 (50.8) | 1.50 (38.1) | 4 | 8 | 9.00 (228.6) | 5000 |
| PDL-55R | A | SL TEDLAR | Red/White | 2.00 (50.8) | 1.38 (34.9) | 0.50 (12.7) | 2.00 (50.8) | 1.50 (38.1) | 4 | 8 | 9.00 (228.6) | 5000 |
| PDL-55Y | A | SL TEDLAR | Yellow/White | 2.00 (50.8) | 1.38 (34.9) | 0.50 (12.7) | 2.00 (50.8) | 1.50 (38.1) | 4 | 8 | 9.00 (228.6) | 5000 |
| PDL-3-1 | A | SL Vinyl | White | 2.00 (50.8) | 1.44 (36.5) | 0.50 (12.7) | 2.00 (50.8) | 1.50 (38.1) | 4 | 8 | 9.00 (228.6) | 1000 |
| PDL-3 | A | SL Vinyl | White | 2.00 (50.8) | 1.44 (36.5) | 0.50 (12.7) | 2.00 (50.8) | 1.50 (38.1) | 4 | 8 | 9.00 (228.6) | 5000 |
| PDL-3B | A | SL Vinyl | Blue/White | 2.00 (50.8) | 1.44 (36.5) | 0.50 (12.7) | 2.00 (50.8) | 1.50 (38.1) | 4 | 8 | 9.00 (228.6) | 5000 |
| PDL-3BR | A | SL Vinyl | Brown/White | 2.00 (50.8) | 1.44 (36.5) | 0.50 (12.7) | 2.00 (50.8) | 1.50 (38.1) | 4 | 8 | 9.00 (228.6) | 5000 |
| PDL-3G | A | SL Vinyl | Green/White | 2.00 (50.8) | 1.44 (36.5) | 0.50 (12.7) | 2.00 (50.8) | 1.50 (38.1) | 4 | 8 | 9.00 (228.6) | 5000 |
| PDL-3GR | A | SL Vinyl | Gray/White | 2.00 (50.8) | 1.44 (36.5) | 0.50 (12.7) | 2.00 (50.8) | 1.50 (38.1) | 4 | 8 | 9.00 (228.6) | 5000 |
| PDL-3OR | A | SL Vinyl | Orange/White | 2.00 (50.8) | 1.44 (36.5) | 0.50 (12.7) | 2.00 (50.8) | 1.50 (38.1) | 4 | 8 | 9.00 (228.6) | 5000 |
| PDL-3PR | A | SL Vinyl | Purple/White | 2.00 (50.8) | 1.44 (36.5) | 0.50 (12.7) | 2.00 (50.8) | 1.50 (38.1) | 4 | 8 | 9.00 (228.6) | 5000 |
| PDL-3R | A | SL Vinyl | Red/White | 2.00 (50.8) | 1.44 (36.5) | 0.50 (12.7) | 2.00 (50.8) | 1.50 (38.1) | 4 | 8 | 9.00 (228.6) | 5000 |
| PDL-3VF | A | Vinyl Free SL | White | 2.00 (50.8) | 1.44 (36.5) | 0.50 (12.7) | 2.00 (50.8) | 1.50 (38.1) | 4 | 8 | 9.00 (228.6) | 5000 |
| PDL-3Y | A | SL Vinyl | Yellow/White | 2.00 (50.8) | 1.44 (36.5) | 0.50 (12.7) | 2.00 (50.8) | 1.50 (38.1) | 4 | 8 | 9.00 (228.6) | 5000 |
| PDL-3-10 | A | SL Vinyl | White | 2.00 (50.8) | 1.44 (36.5) | 0.50 (12.7) | 2.00 (50.8) | 1.50 (38.1) | 4 | 8 | 9.00 (228.6) | 10,000 |
| PDL-5 | A | SL Vinyl | White | 2.00 (50.8) | 2.44 (61.9) | 0.75 (19.1) | 2.00 (50.8) | 2.50 (63.5) | 4 | 4 | 9.00 (228.6) | 1000 |
| PDL-5B | A | SL Vinyl | Blue/White | 2.00 (50.8) | 2.44 (61.9) | 0.75 (19.1) | 2.00 (50.8) | 2.50 (63.5) | 4 | 4 | 9.00 (228.6) | 1000 |
| PDL-5BR | A | SL Vinyl | Brown/White | 2.00 (50.8) | 2.44 (61.9) | 0.75 (19.1) | 2.00 (50.8) | 2.50 (63.5) | 4 | 4 | 9.00 (228.6) | 1000 |
| PDL-5G | A | SL Vinyl | Green/White | 2.00 (50.8) | 2.44 (61.9) | 0.75 (19.1) | 2.00 (50.8) | 2.50 (63.5) | 4 | 4 | 9.00 (228.6) | 1000 |
| PDL-5GR | A | SL Vinyl | Gray/White | 2.00 (50.8) | 2.44 (61.9) | 0.75 (19.1) | 2.00 (50.8) | 2.50 (63.5) | 4 | 4 | 9.00 (228.6) | 1000 |
| PDL-5OR | A | SL Vinyl | Orange/White | 2.00 (50.8) | 2.44 (61.9) | 0.75 (19.1) | 2.00 (50.8) | 2.50 (63.5) | 4 | 4 | 9.00 (228.6) | 1000 |
| PDL-5PR | A | SL Vinyl | Purple/White | 2.00 (50.8) | 2.44 (61.9) | 0.75 (19.1) | 2.00 (50.8) | 2.50 (63.5) | 4 | 4 | 9.00 (228.6) | 1000 |
| PDL-5R | A | SL Vinyl | Red/White | 2.00 (50.8) | 2.44 (61.9) | 0.75 (19.1) | 2.00 (50.8) | 2.50 (63.5) | 4 | 4 | 9.00 (228.6) | 1000 |
| PDL-5Y | A | SL Vinyl | Yellow/White | 2.00 (50.8) | 2.44 (61.9) | 0.75 (19.1) | 2.00 (50.8) | 2.50 (63.5) | 4 | 4 | 9.00 (228.6) | 1000 |
| PDL-5-2.5 | A | SL Vinyl | White | 2.00 (50.8) | 2.44 (61.9) | 0.75 (19.1) | 2.00 (50.8) | 2.50 (63.5) | 4 | 4 | 9.00 (228.6) | 2500 |
| PDL-5-10 | A | SL Vinyl | White | 2.00 (50.8) | 2.44 (61.9) | 0.75 (19.1) | 2.00 (50.8) | 2.50 (63.5) | 4 | 4 | 9.00 (228.6) | 10,000 |
| PDL-5VF-10 | A | Vinyl Free SL | White | 2.00 (50.8) | 2.44 (61.9) | 0.75 (19.1) | 2.00 (50.8) | 2.50 (63.5) | 4 | 4 | 9.00 (228.6) | 10,000 |
| PDL-57 | A | SL TEDLAR | White | 2.00 (50.8) | 2.44 (61.9) | 0.75 (19.1) | 2.00 (50.8) | 2.50 (63.5) | 4 | 4 | 9.00 (228.6) | 1000 |
| PDL-57B | A | SL TEDLAR | Blue/White | 2.00 (50.8) | 2.44 (61.9) | 0.75 (19.1) | 2.00 (50.8) | 2.50 (63.5) | 4 | 4 | 9.00 (228.6) | 1000 |
| PDL-57BR | A | SL TEDLAR | Brown/White | 2.00 (50.8) | 2.44 (61.9) | 0.75 (19.1) | 2.00 (50.8) | 2.50 (63.5) | 4 | 4 | 9.00 (228.6) | 1000 |

▲TEDLAR is the registered trademark of E. I. DuPont Co.
 ‡Wide carriage printer required to print this label
 *Order number of labels required in multiples of Std. Pkg. Qty.

PDL Self-Laminating Labels by Size (cont.)

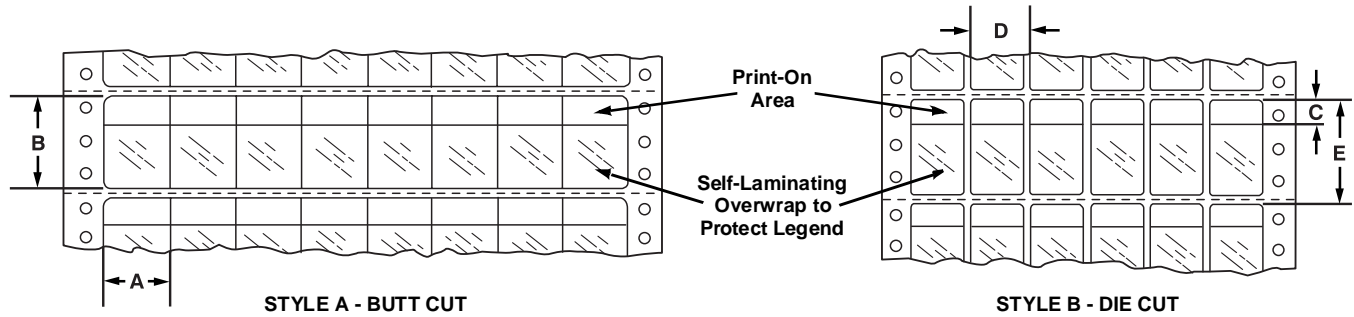

| Part Number | Style | Material | Print-On Area Color | Label Width A In. (mm) | Label Length B In. (mm) | Print-On Length C In. (mm) | Horizontal Repeat D In. (mm) | Vertical Repeat E In. (mm) | Labels Per Row | Rows Per Fanfold | Web Width F In. (mm) | Std. Pkg. Qty.* |
|-------------|-------|---------------|---------------------|---------------------------|----------------------------|-------------------------------|---------------------------------|-------------------------------|----------------|------------------|-------------------------|-----------------|
| PDL-57G | A | SL TEDLAR ▲ | Green/White | 2.00 (50.8) | 2.44 (61.9) | 0.75 (19.1) | 2.00 (50.8) | 2.50 (63.5) | 4 | 4 | 9.00 (228.6) | 1000 |
| PDL-57GR | A | SL TEDLAR | Gray/White | 2.00 (50.8) | 2.44 (61.9) | 0.75 (19.1) | 2.00 (50.8) | 2.50 (63.5) | 4 | 4 | 9.00 (228.6) | 1000 |
| PDL-57OR | A | SL TEDLAR | Orange/White | 2.00 (50.8) | 2.44 (61.9) | 0.75 (19.1) | 2.00 (50.8) | 2.50 (63.5) | 4 | 4 | 9.00 (228.6) | 1000 |
| PDL-57PR | A | SL TEDLAR | Purple/White | 2.00 (50.8) | 2.44 (61.9) | 0.75 (19.1) | 2.00 (50.8) | 2.50 (63.5) | 4 | 4 | 9.00 (228.6) | 1000 |
| PDL-57R | A | SL TEDLAR | Red/White | 2.00 (50.8) | 2.44 (61.9) | 0.75 (19.1) | 2.00 (50.8) | 2.50 (63.5) | 4 | 4 | 9.00 (228.6) | 1000 |
| PDL-57Y | A | SL TEDLAR | Yellow/White | 2.00 (50.8) | 2.44 (61.9) | 0.75 (19.1) | 2.00 (50.8) | 2.50 (63.5) | 4 | 4 | 9.00 (228.6) | 1000 |
| PDL-59 | A | SL TEDLAR | White | 2.00 (50.8) | 3.87 (98.3) | 1.00 (25.4) | 2.00 (50.8) | 4.00 (101.6) | 4 | 3 | 9.00 (228.6) | 1000 |
| PDL-59B | A | SL TEDLAR | Blue/White | 2.00 (50.8) | 3.87 (98.3) | 1.00 (25.4) | 2.00 (50.8) | 4.00 (101.6) | 4 | 3 | 9.00 (228.6) | 1000 |
| PDL-59BR | A | SL TEDLAR | Brown/White | 2.00 (50.8) | 3.87 (98.3) | 1.00 (25.4) | 2.00 (50.8) | 4.00 (101.6) | 4 | 3 | 9.00 (228.6) | 1000 |
| PDL-59G | A | SL TEDLAR | Green/White | 2.00 (50.8) | 3.87 (98.3) | 1.00 (25.4) | 2.00 (50.8) | 4.00 (101.6) | 4 | 3 | 9.00 (228.6) | 1000 |
| PDL-59GR | A | SL TEDLAR | Gray/White | 2.00 (50.8) | 3.87 (98.3) | 1.00 (25.4) | 2.00 (50.8) | 4.00 (101.6) | 4 | 3 | 9.00 (228.6) | 1000 |
| PDL-59OR | A | SL TEDLAR | Orange/White | 2.00 (50.8) | 3.87 (98.3) | 1.00 (25.4) | 2.00 (50.8) | 4.00 (101.6) | 4 | 3 | 9.00 (228.6) | 1000 |
| PDL-59PR | A | SL TEDLAR | Purple/White | 2.00 (50.8) | 3.87 (98.3) | 1.00 (25.4) | 2.00 (50.8) | 4.00 (101.6) | 4 | 3 | 9.00 (228.6) | 1000 |
| PDL-59R | A | SL TEDLAR | Red/White | 2.00 (50.8) | 3.87 (98.3) | 1.00 (25.4) | 2.00 (50.8) | 4.00 (101.6) | 4 | 3 | 9.00 (228.6) | 1000 |
| PDL-59Y | A | SL TEDLAR | Yellow/White | 2.00 (50.8) | 3.87 (98.3) | 1.00 (25.4) | 2.00 (50.8) | 4.00 (101.6) | 4 | 3 | 9.00 (228.6) | 1000 |
| PDL-59-10 | A | SL TEDLAR | White | 2.00 (50.8) | 3.87 (98.3) | 1.00 (25.4) | 2.00 (50.8) | 4.00 (101.6) | 4 | 3 | 9.00 (228.6) | 10,000 |
| PDL-7 | A | SL Vinyl | White | 2.00 (50.8) | 3.94 (100.1) | 1.00 (25.4) | 2.00 (50.8) | 4.00 (101.6) | 4 | 3 | 9.00 (228.6) | 1000 |
| PDL-7B | A | SL Vinyl | Blue/White | 2.00 (50.8) | 3.94 (100.1) | 1.00 (25.4) | 2.00 (50.8) | 4.00 (101.6) | 4 | 3 | 9.00 (228.6) | 1000 |
| PDL-7G | A | SL Vinyl | Green/White | 2.00 (50.8) | 3.94 (100.1) | 1.00 (25.4) | 2.00 (50.8) | 4.00 (101.6) | 4 | 3 | 9.00 (228.6) | 1000 |
| PDL-7R | A | SL Vinyl | Red/White | 2.00 (50.8) | 3.94 (100.1) | 1.00 (25.4) | 2.00 (50.8) | 4.00 (101.6) | 4 | 3 | 9.00 (228.6) | 1000 |
| PDL-7VF | A | Vinyl Free SL | White | 2.00 (50.8) | 3.94 (100.1) | 1.00 (25.4) | 2.00 (50.8) | 4.00 (101.6) | 4 | 3 | 9.00 (228.6) | 1000 |
| PDL-7Y | A | SL Vinyl | Yellow/White | 2.00 (50.8) | 3.94 (100.1) | 1.00 (25.4) | 2.00 (50.8) | 4.00 (101.6) | 4 | 3 | 9.00 (228.6) | 1000 |
| PDL-7-2.5 | A | SL Vinyl | White | 2.00 (50.8) | 3.94 (100.1) | 1.00 (25.4) | 2.00 (50.8) | 4.00 (101.6) | 4 | 3 | 9.00 (228.6) | 2500 |
| PDL-7-10 | A | SL Vinyl | White | 2.00 (50.8) | 3.94 (100.1) | 1.00 (25.4) | 2.00 (50.8) | 4.00 (101.6) | 4 | 3 | 9.00 (228.6) | 10,000 |
| PDL-16 | B | SL Vinyl | White | 2.00 (50.8) | 5.94 (150.9) | 1.50 (38.1) | 2.10 (53.4) | 6.00 (152.4) | 6 | 2 | 13.50 (342.9)‡ | 1000 |
| PDL-16-2.5 | B | SL Vinyl | White | 2.00 (50.8) | 5.94 (150.9) | 1.50 (38.1) | 2.10 (53.4) | 6.00 (152.4) | 6 | 2 | 13.50 (342.9)‡ | 2500 |
| PDL-16-10 | B | SL Vinyl | White | 2.00 (50.8) | 5.94 (150.9) | 1.50 (38.1) | 2.10 (53.4) | 6.00 (152.4) | 6 | 2 | 13.50 (342.9)‡ | 10,000 |
| PDL-62 | B | SL TEDLAR | White | 2.00 (50.8) | 5.94 (150.9) | 1.50 (38.1) | 2.10 (53.4) | 6.00 (152.4) | 6 | 2 | 13.50 (342.9)‡ | 1000 |
| PDL-133 | B | SL Vinyl | White | 2.00 (50.8) | 5.94 (150.9) | 1.50 (38.1) | 2.10 (53.4) | 6.00 (152.4) | 3 | 2 | 7.00 (177.8) | 1000 |
| PDL-134 | B | SL TEDLAR | White | 2.00 (50.8) | 5.94 (150.9) | 1.50 (38.1) | 2.10 (53.4) | 6.00 (152.4) | 3 | 2 | 7.00 (177.8) | 1000 |
| PDL-17 | B | SL Vinyl | White | 2.00 (50.8) | 7.44 (189.0) | 1.50 (38.1) | 2.20 (55.9) | 7.50 (190.5) | 4 | 1 | 9.40 (238.8)‡ | 1000 |
| PDL-17-2.5 | B | SL Vinyl | White | 2.00 (50.8) | 7.44 (189.0) | 1.50 (38.1) | 2.20 (55.9) | 7.50 (190.5) | 4 | 1 | 9.40 (238.8)‡ | 2500 |
| PDL-63 | B | SL TEDLAR | White | 2.00 (50.8) | 7.44 (189.0) | 1.50 (38.1) | 2.20 (55.9) | 7.50 (190.5) | 4 | 1 | 9.40 (238.8)‡ | 1000 |
| PDL-115 | B | SL Vinyl | White | 2.00 (50.8) | 7.44 (189.0) | 1.50 (38.1) | 2.20 (55.9) | 7.50 (190.5) | 3 | 2 | 7.20 (182.9) | 1000 |
| PDL-115-2.5 | B | SL Vinyl | White | 2.00 (50.8) | 7.44 (189.0) | 1.50 (38.1) | 2.20 (55.9) | 7.50 (190.5) | 3 | 2 | 7.20 (182.9) | 2500 |
| PDL-116 | B | SL TEDLAR | White | 2.00 (50.8) | 7.44 (189.0) | 1.50 (38.1) | 2.20 (55.9) | 7.50 (190.5) | 3 | 2 | 7.20 (182.9) | 1000 |
| PDL-362-1 | B | SL Vinyl | White | 2.00 (50.8) | 9.00 (228.6) | 1.50 (38.1) | 2.10 (53.4) | 9.50 (241.3) | 4 | 1 | 9.40 (238.8)‡ | 1000 |

▲TEDLAR is the registered trademark of E. I. DuPont Co.
 ‡Wide carriage printer required to print this label
 *Order number of labels required in multiples of Std. Pkg. Qty.

PDL Blank Labels by Size



STYLE A - BUTT CUT



STYLE B - DIE CUT

| Part Number | Style | Material | Color | Label Width A In. (mm) | Label Length B In. (mm) | Horizontal Repeat D In. (mm) | Vertical Repeat E In. (mm) | Labels Per Row | Rows Per Fanfold | Web Width F In. (mm) | Std. Pkg. Qty.* |
|-------------|-------|--------------|-------|---------------------------|----------------------------|---------------------------------|-------------------------------|----------------|------------------|-------------------------|------------------------|
| PDL-176 | B | Vinyl Cloth | White | 0.25 (6.4) | 1.44 (36.6) | 0.25 (6.4) | 1.50 (38.1) | 36 | 8 | 10.00 (254.0)‡ | 5000 |
| PDL-177 | B | Polyester | White | 0.25 (6.4) | 1.44 (36.6) | 0.25 (6.4) | 1.50 (38.1) | 36 | 8 | 10.00 (254.0)‡ | 5000 |
| PDL-178 | B | Vinyl | White | 0.25 (6.4) | 1.44 (36.6) | 0.25 (6.4) | 1.50 (38.1) | 36 | 8 | 10.00 (254.0)‡ | 5000 |
| PDL-179 | B | TEDLAR ▲ | White | 0.25 (6.4) | 1.44 (36.6) | 0.25 (6.4) | 1.50 (38.1) | 36 | 8 | 10.00 (254.0)‡ | 5000 |
| PDL-347 | B | Vinyl Cloth | White | 0.28 (7.1) | 0.25 (6.4) | 0.40 (10.2) | 0.25 (6.4) | 10 | 2800• | 5.00 (127.0) | 1 Roll (28,000 Labels) |
| PDL-7966-10 | B | TEDLAR | White | 0.30 (7.6) | 0.20 (5.1) | 0.40 (10.2) | 0.33 (8.5) | 16 | 36 | 7.30 (185.4) | 10,000 |
| PDL-252 | A | Polyimide | Amber | 0.30 (7.6) | 0.30 (7.6) | 0.30 (7.6) | 0.50 (12.7) | 16 | 24 | 5.80 (147.3) | 5000 |
| PDL-252-10 | A | Polyimide | Amber | 0.30 (7.6) | 0.30 (7.6) | 0.30 (7.6) | 0.50 (12.7) | 16 | 24 | 5.80 (147.3) | 10,000 |
| PDL-253 | A | Polyester | White | 0.30 (7.6) | 0.30 (7.6) | 0.30 (7.6) | 0.50 (12.7) | 16 | 24 | 5.80 (147.3) | 5000 |
| PDL-253-10 | A | Polyester | White | 0.30 (7.6) | 0.30 (7.6) | 0.30 (7.6) | 0.50 (12.7) | 16 | 24 | 5.80 (147.3) | 10,000 |
| PDL-254 | A | Vinyl Cloth | White | 0.30 (7.6) | 0.75 (19.1) | 0.30 (7.6) | 1.00 (25.4) | 16 | 12 | 5.80 (147.3) | 5000 |
| PDL-256 | A | TEDLAR | White | 0.30 (7.6) | 0.75 (19.1) | 0.30 (7.6) | 1.00 (25.4) | 16 | 12 | 5.80 (147.3) | 5000 |
| PDL-257 | A | Vinyl Cloth | White | 0.30 (7.6) | 0.94 (23.8) | 0.30 (7.6) | 1.00 (25.4) | 16 | 12 | 5.80 (147.3) | 5000 |
| PDL-259 | A | TEDLAR | White | 0.30 (7.6) | 0.94 (23.8) | 0.30 (7.6) | 1.00 (25.4) | 16 | 12 | 5.80 (147.3) | 5000 |
| PDL-351 | B | Vinyl Cloth | White | 0.31 (7.9) | 0.38 (9.5) | 0.40 (10.2) | 0.38 (9.5) | 10 | 1867• | 5.00 (127.0) | 1 Roll (18,670 Labels) |
| PDL-353 | B | Vinyl Cloth | White | 0.31 (7.9) | 0.50 (12.7) | 0.40 (10.2) | 0.50 (12.7) | 10 | 1400• | 5.00 (127.0) | 1 Roll (14,000 Labels) |
| PDL-349 | Strip | Vinyl Cloth | White | 0.31 (7.9) | 700 (17780) | 0.40 (10.2) | — | 10 | 1• | 5.00 (127.0) | 1 Roll (10 Strips) |
| PDL-260 | A | Vinyl Cloth | White | 0.38 (9.5) | 0.38 (9.5) | 0.50 (12.7) | 0.50 (12.7) | 16 | 24 | 8.90 (226.1) | 5000 |
| PDL-262 | A | Polyimide | Amber | 0.38 (9.5) | 0.38 (9.5) | 0.50 (12.7) | 0.50 (12.7) | 16 | 24 | 8.90 (226.1) | 5000 |
| PDL-262-10 | A | Polyimide | Amber | 0.38 (9.5) | 0.38 (9.5) | 0.50 (12.7) | 0.50 (12.7) | 16 | 24 | 8.90 (226.1) | 10,000 |
| PDL-263 | A | Destr. Vinyl | White | 0.38 (9.5) | 0.38 (9.5) | 0.50 (12.7) | 0.50 (12.7) | 16 | 24 | 8.90 (226.1) | 5000 |
| PDL-264 | A | Polyester | White | 0.38 (9.5) | 0.38 (9.5) | 0.50 (12.7) | 0.50 (12.7) | 16 | 24 | 8.90 (226.1) | 5000 |
| PDL-264-10 | A | Polyester | White | 0.38 (9.5) | 0.38 (9.5) | 0.50 (12.7) | 0.50 (12.7) | 16 | 24 | 8.90 (226.1) | 10,000 |
| PDL-180 | B | Vinyl Cloth | White | 0.38 (9.5) | 1.44 (36.6) | 0.38 (9.5) | 1.50 (38.1) | 24 | 8 | 10.00 (254.0)‡ | 5000 |
| PDL-181 | B | Polyester | White | 0.38 (9.5) | 1.44 (36.6) | 0.38 (9.5) | 1.50 (38.1) | 24 | 8 | 10.00 (254.0)‡ | 5000 |
| PDL-182 | B | Vinyl | White | 0.38 (9.5) | 1.44 (36.6) | 0.38 (9.5) | 1.50 (38.1) | 24 | 8 | 10.00 (254.0)‡ | 5000 |
| PDL-183 | B | TEDLAR | White | 0.38 (9.5) | 1.44 (36.6) | 0.38 (9.5) | 1.50 (38.1) | 24 | 8 | 10.00 (254.0)‡ | 5000 |
| PDL-355 | Strip | Vinyl Cloth | White | 0.38 (9.5) | 700 (17780) | 0.50 (12.7) | — | 8 | 1• | 5.00 (127.0) | 1 Roll (8 Strips) |
| PDL-100 | B | TEDLAR | White | 0.44 (11.1) | 2.56 (65.0) | 0.60 (15.2) | 3.00 (76.2) | 12 | 4 | 8.04 (204.2) | 5000 |
| PDL-101 | B | Polyester | White | 0.44 (11.1) | 2.56 (65.0) | 0.60 (15.2) | 3.00 (76.2) | 12 | 4 | 8.04 (204.2) | 5000 |
| PDL-102 | B | Vinyl Cloth | White | 0.44 (11.1) | 2.56 (65.0) | 0.60 (15.2) | 3.00 (76.2) | 12 | 4 | 8.04 (204.2) | 5000 |
| PDL-103 | B | Vinyl | White | 0.44 (11.1) | 2.56 (65.0) | 0.60 (15.2) | 3.00 (76.2) | 12 | 4 | 8.04 (204.2) | 5000 |

▲TEDLAR is the registered trademark of E. I. DuPont Co.

•Indicates label is roll mounted on 3" (76.2 mm) core

‡Wide carriage printer required to print this label

*Order number of labels required in multiples of Std. Pkg. Qty. For roll mounted labels, order number of rolls required in multiples of Std. Pkg. Qty.

PDL Blank Labels by Size (cont.)

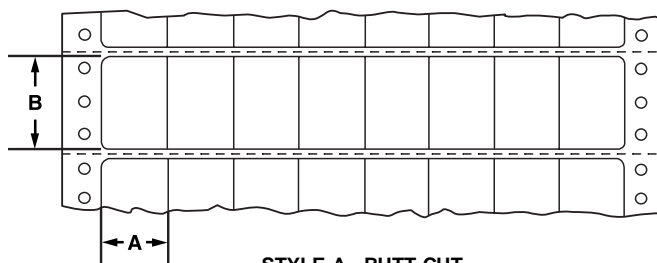

STYLE A - BUTT CUT



STYLE B - DIE CUT

| Part Number | Style | Material | Color | Label Width A In. (mm) | Label Length B In. (mm) | Horizontal Repeat D In. (mm) | Vertical Repeat E In. (mm) | Labels Per Row | Rows Per Fanfold | Web Width F In. (mm) | Std. Pkg. Qty.* |
|-------------|-------|---------------------|--------|---------------------------|----------------------------|---------------------------------|-------------------------------|----------------|------------------|-------------------------|-----------------|
| PDL-104 | B | TEDLAR [†] | White | 0.44 (11.1) | 3.63 (92.1) | 0.60 (15.2) | 4.00 (101.6) | 12 | 3 | 8.04 (204.2) | 5000 |
| PDL-105 | B | Polyester | White | 0.44 (11.1) | 3.63 (92.1) | 0.60 (15.2) | 4.00 (101.6) | 12 | 3 | 8.04 (204.2) | 5000 |
| PDL-106-1 | B | Vinyl Cloth | White | 0.44 (11.1) | 3.63 (92.1) | 0.60 (15.2) | 4.00 (101.6) | 12 | 3 | 8.04 (204.2) | 1000 |
| PDL-106 | B | Vinyl Cloth | White | 0.44 (11.1) | 3.63 (92.1) | 0.60 (15.2) | 4.00 (101.6) | 12 | 3 | 8.04 (204.2) | 5000 |
| PDL-106-10 | B | Vinyl Cloth | White | 0.44 (11.1) | 3.63 (92.1) | 0.60 (15.2) | 4.00 (101.6) | 12 | 3 | 8.04 (204.2) | 10,000 |
| PDL-107 | B | Vinyl | White | 0.44 (11.1) | 3.63 (92.1) | 0.60 (15.2) | 4.00 (101.6) | 12 | 3 | 8.04 (204.2) | 5000 |
| PDL-45-1 | A | Vinyl Cloth | White | 0.50 (12.7) | 0.44 (11.1) | 0.50 (12.7) | 0.50 (12.7) | 16 | 24 | 9.00 (228.6) | 1000 |
| PDL-45 | A | Vinyl Cloth | White | 0.50 (12.7) | 0.44 (11.1) | 0.50 (12.7) | 0.50 (12.7) | 16 | 24 | 9.00 (228.6) | 5000 |
| PDL-45-10 | A | Vinyl Cloth | White | 0.50 (12.7) | 0.44 (11.1) | 0.50 (12.7) | 0.50 (12.7) | 16 | 24 | 9.00 (228.6) | 10,000 |
| PDL-46 | A | Destr. Vinyl | White | 0.50 (12.7) | 0.44 (11.1) | 0.50 (12.7) | 0.50 (12.7) | 16 | 24 | 9.00 (228.6) | 5000 |
| PDL-47 | A | Polyester | White | 0.50 (12.7) | 0.44 (11.1) | 0.50 (12.7) | 0.50 (12.7) | 16 | 24 | 9.00 (228.6) | 5000 |
| PDL-47-10 | A | Polyester | White | 0.50 (12.7) | 0.44 (11.1) | 0.50 (12.7) | 0.50 (12.7) | 16 | 24 | 9.00 (228.6) | 10,000 |
| PDL-48-1 | A | Polyester | Silver | 0.50 (12.7) | 0.44 (11.1) | 0.50 (12.7) | 0.50 (12.7) | 16 | 24 | 9.00 (228.6) | 1000 |
| PDL-48 | A | Polyester | Silver | 0.50 (12.7) | 0.44 (11.1) | 0.50 (12.7) | 0.50 (12.7) | 16 | 24 | 9.00 (228.6) | 5000 |
| PDL-48-10 | A | Polyester | Silver | 0.50 (12.7) | 0.44 (11.1) | 0.50 (12.7) | 0.50 (12.7) | 16 | 24 | 9.00 (228.6) | 10,000 |
| PDL-91 | A | Remov. Paper | White | 0.50 (12.7) | 0.44 (11.1) | 0.50 (12.7) | 0.50 (12.7) | 16 | 24 | 9.00 (228.6) | 5000 |
| PDL-43 | B | Vinyl Cloth | White | 0.50 (12.7) | 0.75 (19.1) | 0.60 (15.2) | 1.00 (25.4) | 14 | 12 | 9.30 (236.2)‡ | 5000 |
| PDL-43-10 | B | Vinyl Cloth | White | 0.50 (12.7) | 0.75 (19.1) | 0.60 (15.2) | 1.00 (25.4) | 14 | 12 | 9.30 (236.2)‡ | 10,000 |
| PDL-44 | B | TEDLAR | White | 0.50 (12.7) | 0.75 (19.1) | 0.60 (15.2) | 1.00 (25.4) | 14 | 12 | 9.30 (236.2)‡ | 5000 |
| PDL-89 | B | Destr. Paper | White | 0.50 (12.7) | 0.75 (19.1) | 0.60 (15.2) | 1.00 (25.4) | 14 | 12 | 9.30 (236.2)‡ | 5000 |
| PDL-90 | B | Polyester | White | 0.50 (12.7) | 0.75 (19.1) | 0.60 (15.2) | 1.00 (25.4) | 14 | 12 | 9.30 (236.2)‡ | 5000 |
| PDL-119 | B | Vinyl Cloth | White | 0.50 (12.7) | 0.75 (19.1) | 0.60 (15.2) | 1.00 (25.4) | 12 | 12 | 8.10 (205.7) | 5000 |
| PDL-120 | B | TEDLAR | White | 0.50 (12.7) | 0.75 (19.1) | 0.60 (15.2) | 1.00 (25.4) | 12 | 12 | 8.10 (205.7) | 5000 |
| PDL-120-10 | B | TEDLAR | White | 0.50 (12.7) | 0.75 (19.1) | 0.60 (15.2) | 1.00 (25.4) | 12 | 12 | 8.10 (205.7) | 10,000 |
| PDL-121 | B | Polyester | White | 0.50 (12.7) | 0.75 (19.1) | 0.60 (15.2) | 1.00 (25.4) | 12 | 12 | 8.10 (205.7) | 5000 |
| PDL-122 | B | Destr. Paper | White | 0.50 (12.7) | 0.75 (19.1) | 0.60 (15.2) | 1.00 (25.4) | 12 | 12 | 8.10 (205.7) | 5000 |
| PDL-265 | A | Vinyl Cloth | White | 0.50 (12.7) | 0.94 (23.8) | 0.50 (12.7) | 1.00 (25.4) | 16 | 12 | 9.00 (228.6) | 5000 |
| PDL-267 | A | TEDLAR | White | 0.50 (12.7) | 0.94 (23.8) | 0.50 (12.7) | 1.00 (25.4) | 16 | 12 | 9.00 (228.6) | 5000 |
| PDL-13-1 | B | Vinyl Cloth | White | 0.50 (12.7) | 1.44 (36.5) | 0.60 (15.2) | 1.50 (38.1) | 12 | 8 | 8.10 (205.7) | 1000 |
| PDL-13 | B | Vinyl Cloth | White | 0.50 (12.7) | 1.44 (36.5) | 0.60 (15.2) | 1.50 (38.1) | 12 | 8 | 8.10 (205.7) | 5000 |
| PDL-13-10 | B | Vinyl Cloth | White | 0.50 (12.7) | 1.44 (36.5) | 0.60 (15.2) | 1.50 (38.1) | 12 | 8 | 8.10 (205.7) | 10,000 |
| PDL-14 | B | Polyester | White | 0.50 (12.7) | 1.44 (36.5) | 0.60 (15.2) | 1.50 (38.1) | 12 | 8 | 8.10 (205.7) | 5000 |
| PDL-14-10 | B | Polyester | White | 0.50 (12.7) | 1.44 (36.5) | 0.60 (15.2) | 1.50 (38.1) | 12 | 8 | 8.10 (205.7) | 10,000 |
| PDL-15 | B | Vinyl | White | 0.50 (12.7) | 1.44 (36.5) | 0.60 (15.2) | 1.50 (38.1) | 12 | 8 | 8.10 (205.7) | 5000 |
| PDL-184 | B | Vinyl Cloth | White | 0.50 (12.7) | 1.44 (36.5) | 0.50 (12.7) | 1.50 (38.1) | 18 | 8 | 10.00 (254.0)‡ | 5000 |
| PDL-185 | B | Polyester | White | 0.50 (12.7) | 1.44 (36.5) | 0.50 (12.7) | 1.50 (38.1) | 18 | 8 | 10.00 (254.0)‡ | 5000 |
| PDL-186 | B | Vinyl | White | 0.50 (12.7) | 1.44 (36.5) | 0.50 (12.7) | 1.50 (38.1) | 18 | 8 | 10.00 (254.0)‡ | 5000 |
| PDL-187 | B | TEDLAR | White | 0.50 (12.7) | 1.44 (36.5) | 0.50 (12.7) | 1.50 (38.1) | 18 | 8 | 10.00 (254.0)‡ | 5000 |

*TEDLAR is the registered trademark of E. I. DuPont Co.
 †Wide carriage printer required to print this label.
 ‡Order number of labels required in multiples of Std. Pkg. Qty.

PDL Blank Labels by Size (cont.)

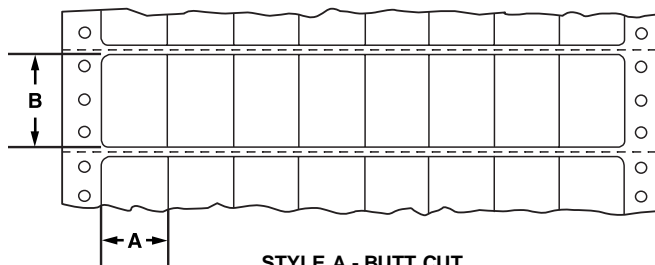

STYLE A - BUTT CUT

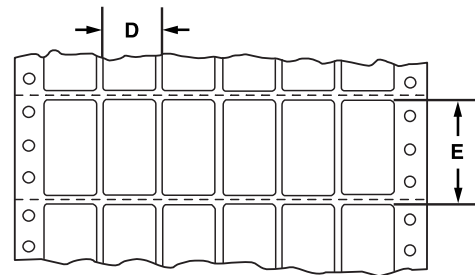

STYLE B - DIE CUT

| Part Number | Style | Material | Color | Label Width A In. (mm) | Label Length B In. (mm) | Horizontal Repeat D In. (mm) | Vertical Repeat E In. (mm) | Labels Per Row | Rows Per Fanfold | Web Width F In. (mm) | Std. Pkg. Qty.* |
|--|-------|---------------------|-------------|---------------------------|----------------------------|---------------------------------|-------------------------------|----------------|------------------|-------------------------|-----------------|
| PDL-135 thru PDL-138 have a horizontal slit 0.13" (3.2mm) from top of label (see drawing below) | | | | | | | | | | | |
| PDL-135 | B | Vinyl Cloth | White | 0.50 (12.7) | 1.44 (36.5) | 0.60 (15.2) | 1.50 (38.1) | 12 | 8 | 8.10 (205.7) | 5000 |
| PDL-136 | B | Polyester | White | 0.50 (12.7) | 1.44 (36.5) | 0.60 (15.2) | 1.50 (38.1) | 12 | 8 | 8.10 (205.7) | 5000 |
| PDL-137 | B | TEDLAR [▲] | White | 0.50 (12.7) | 1.44 (36.5) | 0.60 (15.2) | 1.50 (38.1) | 12 | 8 | 8.10 (205.7) | 5000 |
| PDL-138 | B | Destr. Paper | White | 0.50 (12.7) | 1.44 (36.5) | 0.60 (15.2) | 1.50 (38.1) | 12 | 8 | 8.10 (205.7) | 5000 |
| PDL-402-D | B | Polyester | Clear | 0.56 (14.3) | 0.19 (4.8) | 0.70 (17.8) | 0.33 (8.5) | 10 | 36 | 7.86 (199.6) | 500 |
| PDL-402-10 | B | Polyester | Clear | 0.56 (14.3) | 0.19 (4.8) | 0.70 (17.8) | 0.33 (8.5) | 10 | 36 | 7.86 (199.6) | 10,000 |
| PDL-405-D | B | Polyester | White | 0.56 (14.3) | 0.19 (4.8) | 0.70 (17.8) | 0.33 (8.5) | 10 | 36 | 7.86 (199.6) | 500 |
| PDL-405-10 | B | Polyester | White | 0.56 (14.3) | 0.19 (4.8) | 0.70 (17.8) | 0.33 (8.5) | 10 | 36 | 7.86 (199.6) | 10,000 |
| PDL-400 | B | Polyester | Elec. Ivory | 0.56 (14.3) | 0.56 (14.3) | 0.70 (17.8) | 0.75 (19.1) | 10 | 16 | 7.86 (199.6) | 5000 |
| PDL-401-D | B | Polyester | Clear | 0.56 (14.3) | 0.56 (14.3) | 0.70 (17.8) | 0.75 (19.1) | 10 | 16 | 7.86 (199.6) | 500 |
| PDL-401 | B | Polyester | Clear | 0.56 (14.3) | 0.56 (14.3) | 0.70 (17.8) | 0.75 (19.1) | 10 | 16 | 7.86 (199.6) | 5000 |
| PDL-401-10 | B | Polyester | Clear | 0.56 (14.3) | 0.56 (14.3) | 0.70 (17.8) | 0.75 (19.1) | 10 | 16 | 7.86 (199.6) | 10,000 |
| PDL-406-D | B | Polyester | White | 0.56 (14.3) | 0.56 (14.3) | 0.70 (17.8) | 0.75 (19.1) | 10 | 16 | 7.86 (199.6) | 500 |
| PDL-406-10 | B | Polyester | White | 0.56 (14.3) | 0.56 (14.3) | 0.70 (17.8) | 0.75 (19.1) | 10 | 16 | 7.86 (199.6) | 10,000 |
| PDL-193 | B | Vinyl Cloth | Yellow | 0.59 (15.0) | 0.35 (9.0) | 0.70 (17.8) | 0.50 (12.7) | 12 | 24 | 9.30 (236.2)‡ | 5000 |
| PDL-194 | B | Vinyl Cloth | White | 0.59 (15.0) | 0.35 (9.0) | 0.70 (17.8) | 0.50 (12.7) | 12 | 24 | 9.30 (236.2)‡ | 5000 |
| PDL-34-1 | B | Vinyl Cloth | White | 0.65 (16.5) | 0.20 (5.1) | 0.80 (20.3) | 0.25 (6.4) | 10 | 48 | 8.85 (224.8) | 1000 |
| PDL-34 | B | Vinyl Cloth | White | 0.65 (16.5) | 0.20 (5.1) | 0.80 (20.3) | 0.25 (6.4) | 10 | 48 | 8.85 (224.8) | 5000 |
| PDL-34-10 | B | Vinyl Cloth | White | 0.65 (16.5) | 0.20 (5.1) | 0.80 (20.3) | 0.25 (6.4) | 10 | 48 | 8.85 (224.8) | 10,000 |
| PDL-35-1 | B | Destr. Vinyl | White | 0.65 (16.5) | 0.20 (5.1) | 0.80 (20.3) | 0.25 (6.4) | 10 | 48 | 8.85 (224.8) | 1000 |
| PDL-35 | B | Destr. Vinyl | White | 0.65 (16.5) | 0.20 (5.1) | 0.80 (20.3) | 0.25 (6.4) | 10 | 48 | 8.85 (224.8) | 5000 |
| PDL-35-10 | B | Destr. Vinyl | White | 0.65 (16.5) | 0.20 (5.1) | 0.80 (20.3) | 0.25 (6.4) | 10 | 48 | 8.85 (224.8) | 10,000 |
| PDL-36 | B | Polyester | White | 0.65 (16.5) | 0.20 (5.1) | 0.80 (20.3) | 0.25 (6.4) | 10 | 48 | 8.85 (224.8) | 5000 |
| PDL-36-10 | B | Polyester | White | 0.65 (16.5) | 0.20 (5.1) | 0.80 (20.3) | 0.25 (6.4) | 10 | 48 | 8.85 (224.8) | 10,000 |
| PDL-82 | B | Destr. Paper | White | 0.65 (16.5) | 0.20 (5.1) | 0.80 (20.3) | 0.25 (6.4) | 10 | 48 | 8.85 (224.8) | 5000 |
| PDL-83 | B | TEDLAR | White | 0.65 (16.5) | 0.20 (5.1) | 0.80 (20.3) | 0.25 (6.4) | 10 | 48 | 8.85 (224.8) | 5000 |
| PDL-83-10 | B | TEDLAR | White | 0.65 (16.5) | 0.20 (5.1) | 0.80 (20.3) | 0.25 (6.4) | 10 | 48 | 8.85 (224.8) | 10,000 |
| PDL-189 | B | Vinyl | White | 0.65 (16.5) | 0.20 (5.1) | 0.80 (20.3) | 0.25 (6.4) | 10 | 48 | 8.85 (224.8) | 5000 |
| PDL-233 | B | Polyimide | Amber | 0.65 (16.5) | 0.20 (5.1) | 0.80 (20.3) | 0.25 (6.4) | 10 | 48 | 8.85 (224.8) | 5000 |
| PDL-233-10 | B | Polyimide | Amber | 0.65 (16.5) | 0.20 (5.1) | 0.80 (20.3) | 0.25 (6.4) | 10 | 48 | 8.85 (224.8) | 10,000 |
| PDL-234 | B | Polyester | Silver | 0.65 (16.5) | 0.20 (5.1) | 0.80 (20.3) | 0.25 (6.4) | 10 | 48 | 8.85 (224.8) | 5000 |
| PDL-234-10 | B | Polyester | Silver | 0.65 (16.5) | 0.20 (5.1) | 0.80 (20.3) | 0.25 (6.4) | 10 | 48 | 8.85 (224.8) | 10,000 |
| PDL-269 has tamper resistant slits (see drawing below) | | | | | | | | | | | |
| PDL-269 | B | Polyester | White | 0.65 (16.5) | 0.20 (5.1) | 0.80 (20.3) | 0.25 (6.4) | 10 | 48 | 8.85 (224.8) | 5000 |

▲TEDLAR is the registered trademark of E. I. DuPont Co.
 ‡Wide carriage printer required to print this label
 *Order number of labels required in multiples of Std. Pkg. Qty.

PDL-135
 PDL-136
 PDL-137
 PDL-138



PDL-269

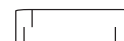

PDL Blank Labels by Size (cont.)

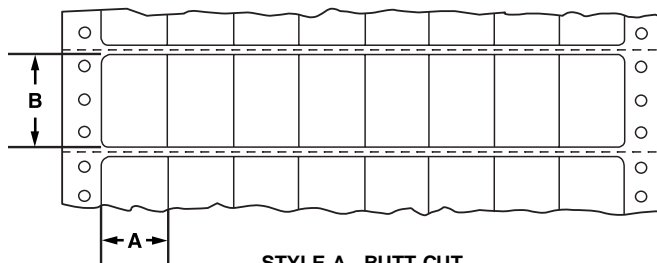

STYLE A - BUTT CUT



STYLE B - DIE CUT

| Part Number | Style | Material | Color | Label Width A In. (mm) | Label Length B In. (mm) | Horizontal Repeat D In. (mm) | Vertical Repeat E In. (mm) | Labels Per Row | Rows Per Fanfold | Web Width F In. (mm) | Std. Pkg. Qty.* |
|--|-------|--------------|--------|---------------------------|----------------------------|---------------------------------|-------------------------------|----------------|------------------|-------------------------|------------------------|
| PDL-37-1 | B | Vinyl Cloth | White | 0.75 (19.1) | 0.25 (6.4) | 0.90 (22.9) | 0.33 (8.5) | 9 | 36 | 9.00 (228.6) | 1000 |
| PDL-37 | B | Vinyl Cloth | White | 0.75 (19.1) | 0.25 (6.4) | 0.90 (22.9) | 0.33 (8.5) | 9 | 36 | 9.00 (228.6) | 5000 |
| PDL-37-10 | B | Vinyl Cloth | White | 0.75 (19.1) | 0.25 (6.4) | 0.90 (22.9) | 0.33 (8.5) | 9 | 36 | 9.00 (228.6) | 10,000 |
| PDL-37-50 | B | Vinyl Cloth | White | 0.75 (19.1) | 0.25 (6.4) | 0.90 (22.9) | 0.33 (8.5) | 9 | 36 | 9.00 (228.6) | 50,000 |
| PDL-38 | B | Destr. Vinyl | White | 0.75 (19.1) | 0.25 (6.4) | 0.90 (22.9) | 0.33 (8.5) | 9 | 36 | 9.00 (228.6) | 5000 |
| PDL-38-10 | B | Destr. Vinyl | White | 0.75 (19.1) | 0.25 (6.4) | 0.90 (22.9) | 0.33 (8.5) | 9 | 36 | 9.00 (228.6) | 10,000 |
| PDL-39 | B | Polyester | White | 0.75 (19.1) | 0.25 (6.4) | 0.90 (22.9) | 0.33 (8.5) | 9 | 36 | 9.00 (228.6) | 5000 |
| PDL-39-10 | B | Polyester | White | 0.75 (19.1) | 0.25 (6.4) | 0.90 (22.9) | 0.33 (8.5) | 9 | 36 | 9.00 (228.6) | 10,000 |
| PDL-84 | B | TEDLAR ▲ | White | 0.75 (19.1) | 0.25 (6.4) | 0.90 (22.9) | 0.33 (8.5) | 9 | 36 | 9.00 (228.6) | 5000 |
| PDL-85 | B | Destr. Paper | White | 0.75 (19.1) | 0.25 (6.4) | 0.90 (22.9) | 0.33 (8.5) | 9 | 36 | 9.00 (228.6) | 5000 |
| PDL-190 | B | Vinyl | White | 0.75 (19.1) | 0.25 (6.4) | 0.90 (22.9) | 0.33 (8.5) | 9 | 36 | 9.00 (228.6) | 5000 |
| PDL-235 | B | Polyimide | Amber | 0.75 (19.1) | 0.25 (6.4) | 0.90 (22.9) | 0.33 (8.5) | 9 | 36 | 9.00 (228.6) | 5000 |
| PDL-235-10 | B | Polyimide | Amber | 0.75 (19.1) | 0.25 (6.4) | 0.90 (22.9) | 0.33 (8.5) | 9 | 36 | 9.00 (228.6) | 10,000 |
| PDL-236 | B | Polyester | Silver | 0.75 (19.1) | 0.25 (6.4) | 0.90 (22.9) | 0.33 (8.5) | 9 | 36 | 9.00 (228.6) | 5000 |
| PDL-236-10 | B | Polyester | Silver | 0.75 (19.1) | 0.25 (6.4) | 0.90 (22.9) | 0.33 (8.5) | 9 | 36 | 9.00 (228.6) | 10,000 |
| PDL-270 | B | Vinyl Cloth | White | 0.75 (19.1) | 0.25 (6.4) | 0.90 (22.9) | 0.38 (9.5) | 9 | 32 | 9.00 (228.6) | 5000 |
| PDL-272 | B | Polyimide | Amber | 0.75 (19.1) | 0.25 (6.4) | 0.90 (22.9) | 0.38 (9.5) | 9 | 32 | 9.00 (228.6) | 5000 |
| PDL-273 | B | Destr. Vinyl | White | 0.75 (19.1) | 0.25 (6.4) | 0.90 (22.9) | 0.38 (9.5) | 9 | 32 | 9.00 (228.6) | 5000 |
| PDL-274 | B | Polyester | White | 0.75 (19.1) | 0.25 (6.4) | 0.90 (22.9) | 0.38 (9.5) | 9 | 32 | 9.00 (228.6) | 5000 |
| PDL-274-10 | B | Polyester | White | 0.75 (19.1) | 0.25 (6.4) | 0.90 (22.9) | 0.38 (9.5) | 9 | 32 | 9.00 (228.6) | 10,000 |
| PDL-275 | B | Polyester | Silver | 0.75 (19.1) | 0.25 (6.4) | 0.90 (22.9) | 0.38 (9.5) | 9 | 32 | 9.00 (228.6) | 5000 |
| PDL-276 thru PDL-277-10 have tamper resistant slits (see drawing below) | | | | | | | | | | | |
| PDL-276 | B | Polyimide | Amber | 0.75 (19.1) | 0.25 (6.4) | 0.90 (22.9) | 0.33 (8.5) | 9 | 36 | 9.00 (228.6) | 5000 |
| PDL-277 | B | Polyester | White | 0.75 (19.1) | 0.25 (6.4) | 0.90 (22.9) | 0.33 (8.5) | 9 | 36 | 9.00 (228.6) | 5000 |
| PDL-277-10 | B | Polyester | White | 0.75 (19.1) | 0.25 (6.4) | 0.90 (22.9) | 0.33 (8.5) | 9 | 36 | 9.00 (228.6) | 10,000 |
| PDL-191 | B | Vinyl Cloth | Yellow | 0.79 (20.0) | 0.32 (8.0) | 0.90 (22.9) | 0.50 (12.7) | 9 | 24 | 9.00 (228.6) | 5000 |
| PDL-192 | B | Vinyl Cloth | White | 0.79 (20.0) | 0.32 (8.0) | 0.90 (22.9) | 0.50 (12.7) | 9 | 24 | 9.00 (228.6) | 5000 |
| PDL-278 | A | Polyimide | Amber | 0.80 (20.3) | 0.20 (5.1) | 0.80 (20.3) | 0.33 (8.5) | 10 | 36 | 9.00 (228.6) | 5000 |
| PDL-279 | A | Polyester | White | 0.80 (20.3) | 0.20 (5.1) | 0.80 (20.3) | 0.33 (8.5) | 10 | 36 | 9.00 (228.6) | 5000 |
| PDL-279-10 | A | Polyester | White | 0.80 (20.3) | 0.20 (5.1) | 0.80 (20.3) | 0.33 (8.5) | 10 | 36 | 9.00 (228.6) | 10,000 |
| PDL-167 | B | Destr. Paper | White | 0.80 (20.3) | 0.25 (6.4) | 0.80 (20.3) | 0.38 (9.5) | 10 | 32 | 9.00 (228.6) | 5000 |
| PDL-170 | B | Remov. Paper | White | 0.80 (20.3) | 0.50 (12.7) | 0.80 (20.3) | 0.63 (15.9) | 10 | 16 | 9.00 (228.6) | 5000 |
| PDL-170-10 | B | Remov. Paper | White | 0.80 (20.3) | 0.50 (12.7) | 0.80 (20.3) | 0.63 (15.9) | 10 | 16 | 9.00 (228.6) | 10,000 |
| PDL-171 | B | Vinyl | White | 0.80 (20.3) | 0.50 (12.7) | 0.80 (20.3) | 0.63 (15.9) | 10 | 16 | 9.00 (228.6) | 5000 |
| PDL-172 | B | Polyester | White | 0.80 (20.3) | 0.50 (12.7) | 0.80 (20.3) | 0.63 (15.9) | 10 | 16 | 9.00 (228.6) | 5000 |
| PDL-172-10 | B | Polyester | White | 0.80 (20.3) | 0.50 (12.7) | 0.80 (20.3) | 0.63 (15.9) | 10 | 16 | 9.00 (228.6) | 10,000 |
| PDL-173 | B | Polyimide | Amber | 0.80 (20.3) | 0.50 (12.7) | 0.80 (20.3) | 0.63 (15.9) | 10 | 16 | 9.00 (228.6) | 5000 |
| PDL-174 | B | Destr. Paper | White | 0.80 (20.3) | 0.50 (12.7) | 0.80 (20.3) | 0.63 (15.9) | 10 | 16 | 9.00 (228.6) | 5000 |
| PDL-172R | B | Polyester | White | 0.80 (20.3) | 0.50 (12.7) | 0.80 (20.3) | 0.63 (15.9) | 10 | 1000• | 9.00 (228.6) | 1 Roll (10,000 Labels) |

▲TEDLAR is the registered trademark of E. I. DuPont Co.

•Indicates label is roll mounted on 3" (76.2 mm) core

*Order number of labels required in multiples of Std. Pkg. Qty. For roll mounted labels, order number of rolls required in multiples of Std. Pkg. Qty.

PDL-276
PDL-277
PDL-277-10



PDL Blank Labels by Size (cont.)



STYLE A - BUTT CUT

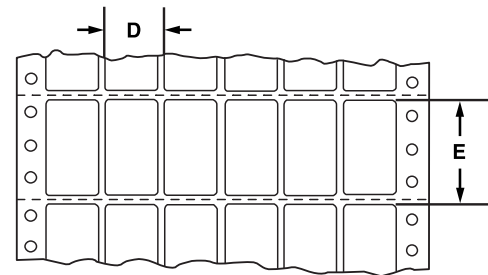

STYLE B - DIE CUT

| Part Number | Style | Material | Color | Label Width A In. (mm) | Label Length B In. (mm) | Horizontal Repeat D In. (mm) | Vertical Repeat E In. (mm) | Labels Per Row | Rows Per Fanfold | Web Width F In. (mm) | Std. Pkg. Qty.* |
|--|-------|--------------|--------|---------------------------|----------------------------|---------------------------------|-------------------------------|----------------|------------------|-------------------------|-----------------|
| PDL-280 | A | Vinyl Cloth | White | 0.80 (20.3) | 0.94 (23.8) | 0.80 (20.3) | 1.00 (25.4) | 10 | 12 | 9.00 (228.6) | 5000 |
| PDL-280-10 | A | Vinyl Cloth | White | 0.80 (20.3) | 0.94 (23.8) | 0.80 (20.3) | 1.00 (25.4) | 10 | 12 | 9.00 (228.6) | 10,000 |
| PDL-282 | A | TEDLAR* | White | 0.80 (20.3) | 0.94 (23.8) | 0.80 (20.3) | 1.00 (25.4) | 10 | 12 | 9.00 (228.6) | 5000 |
| PDL-9 | B | Vinyl Cloth | White | 0.80 (20.3) | 1.44 (36.5) | 0.90 (22.9) | 1.50 (38.1) | 6 | 8 | 6.30 (160.0) | 5000 |
| PDL-9-10 | B | Vinyl Cloth | White | 0.80 (20.3) | 1.44 (36.5) | 0.90 (22.9) | 1.50 (38.1) | 6 | 8 | 6.30 (160.0) | 10,000 |
| PDL-9-10T On Thin Liner | B | Vinyl Cloth | White | 0.80 (20.3) | 1.44 (36.5) | 0.90 (22.9) | 1.50 (38.1) | 6 | 8 | 6.30 (160.0) | 10,000 |
| PDL-10-1 | B | TEDLAR | White | 0.80 (20.3) | 1.44 (36.5) | 0.90 (22.9) | 1.50 (38.1) | 6 | 8 | 6.30 (160.0) | 1000 |
| PDL-10 | B | TEDLAR | White | 0.80 (20.3) | 1.44 (36.5) | 0.90 (22.9) | 1.50 (38.1) | 6 | 8 | 6.30 (160.0) | 5000 |
| PDL-11 | B | Vinyl | White | 0.80 (20.3) | 1.44 (36.5) | 0.90 (22.9) | 1.50 (38.1) | 6 | 8 | 6.30 (160.0) | 5000 |
| PDL-175 | B | Polyester | Silver | 0.81 (20.7) | 0.50 (12.7) | 0.80 (20.3) | 0.63 (15.9) | 10 | 16 | 9.00 (228.6) | 5000 |
| PDL-23-1 | B | TEDLAR | White | 0.90 (22.9) | 0.25 (6.4) | 1.00 (25.4) | 0.33 (8.5) | 10 | 36 | 10.90 (276.9)‡ | 1000 |
| PDL-23 | B | TEDLAR | White | 0.90 (22.9) | 0.25 (6.4) | 1.00 (25.4) | 0.33 (8.5) | 10 | 36 | 10.90 (276.9)‡ | 5000 |
| PDL-23-10 | B | TEDLAR | White | 0.90 (22.9) | 0.25 (6.4) | 1.00 (25.4) | 0.33 (8.5) | 10 | 36 | 10.90 (276.9)‡ | 10,000 |
| PDL-49 | B | TEDLAR | White | 0.90 (22.9) | 0.25 (6.4) | 1.00 (25.4) | 0.33 (8.5) | 8 | 36 | 8.90 (226.1) | 5000 |
| PDL-49-10 | B | TEDLAR | White | 0.90 (22.9) | 0.25 (6.4) | 1.00 (25.4) | 0.33 (8.5) | 8 | 36 | 8.90 (226.1) | 10,000 |
| PDL-50 | B | Polyimide | Amber | 0.90 (22.9) | 0.25 (6.4) | 1.00 (25.4) | 0.33 (8.5) | 8 | 36 | 8.90 (226.1) | 5000 |
| PDL-50-10 | B | Polyimide | Amber | 0.90 (22.9) | 0.25 (6.4) | 1.00 (25.4) | 0.33 (8.5) | 8 | 36 | 8.90 (226.1) | 10,000 |
| PDL-66 | B | Vinyl Cloth | White | 0.90 (22.9) | 0.25 (6.4) | 1.00 (25.4) | 0.33 (8.5) | 10 | 36 | 10.90 (276.9)‡ | 5000 |
| PDL-67 | B | Destr. Paper | White | 0.90 (22.9) | 0.25 (6.4) | 1.00 (25.4) | 0.33 (8.5) | 10 | 36 | 10.90 (276.9)‡ | 5000 |
| PDL-68 | B | Polyester | Silver | 0.90 (22.9) | 0.25 (6.4) | 1.00 (25.4) | 0.33 (8.5) | 10 | 36 | 10.90 (276.9)‡ | 5000 |
| PDL-92 | B | Destr. Paper | White | 0.90 (22.9) | 0.25 (6.4) | 1.00 (25.4) | 0.33 (8.5) | 8 | 36 | 8.90 (226.1) | 5000 |
| PDL-93 | B | Vinyl Cloth | White | 0.90 (22.9) | 0.25 (6.4) | 1.00 (25.4) | 0.33 (8.5) | 8 | 36 | 8.90 (226.1) | 5000 |
| PDL-94-1 | B | Polyester | White | 0.90 (22.9) | 0.25 (6.4) | 1.00 (25.4) | 0.33 (8.5) | 8 | 36 | 8.90 (226.1) | 1000 |
| PDL-94 | B | Polyester | White | 0.90 (22.9) | 0.25 (6.4) | 1.00 (25.4) | 0.33 (8.5) | 8 | 36 | 8.90 (226.1) | 5000 |
| PDL-94-10 | B | Polyester | White | 0.90 (22.9) | 0.25 (6.4) | 1.00 (25.4) | 0.33 (8.5) | 8 | 36 | 8.90 (226.1) | 10,000 |
| PDL-283 | B | Polyimide | Amber | 0.90 (22.9) | 0.25 (6.4) | 1.00 (25.4) | 0.38 (9.5) | 8 | 32 | 8.90 (226.1) | 5000 |
| PDL-284 | B | TEDLAR | White | 0.90 (22.9) | 0.25 (6.4) | 1.00 (25.4) | 0.38 (9.5) | 8 | 32 | 8.90 (226.1) | 5000 |
| PDL-285 | B | Polyester | White | 0.90 (22.9) | 0.25 (6.4) | 1.00 (25.4) | 0.38 (9.5) | 8 | 32 | 8.90 (226.1) | 5000 |
| PDL-286 and PDL-287 have tamper resistant slits (see drawing below) | | | | | | | | | | | |
| PDL-286 | B | Polyimide | Amber | 0.90 (22.9) | 0.25 (6.4) | 1.00 (25.4) | 0.33 (8.5) | 8 | 36 | 8.90 (226.1) | 5000 |
| PDL-287 | B | Polyester | White | 0.90 (22.9) | 0.25 (6.4) | 1.00 (25.4) | 0.33 (8.5) | 8 | 36 | 8.90 (226.1) | 5000 |
| PDL-4565-1 | B | TEDLAR | White | 0.98 (25.0) | 0.59 (15.0) | 1.11 (28.2) | 0.75 (19.1) | 7 | 16 | 8.62 (219.0) | 5000 |
| PDL-30-1 | B | Vinyl Cloth | White | 1.00 (25.4) | 0.38 (9.5) | 1.10 (27.9) | 0.50 (12.7) | 7 | 24 | 8.60 (218.4) | 1000 |
| PDL-30 | B | Vinyl Cloth | White | 1.00 (25.4) | 0.38 (9.5) | 1.10 (27.9) | 0.50 (12.7) | 7 | 24 | 8.60 (218.4) | 5000 |
| PDL-30-10 | B | Vinyl Cloth | White | 1.00 (25.4) | 0.38 (9.5) | 1.10 (27.9) | 0.50 (12.7) | 7 | 24 | 8.60 (218.4) | 10,000 |
| PDL-31 | B | Polyester | White | 1.00 (25.4) | 0.38 (9.5) | 1.10 (27.9) | 0.50 (12.7) | 7 | 24 | 8.60 (218.4) | 5000 |
| PDL-31-10 | B | Polyester | White | 1.00 (25.4) | 0.38 (9.5) | 1.10 (27.9) | 0.50 (12.7) | 7 | 24 | 8.60 (218.4) | 10,000 |
| PDL-74 | B | Destr. Paper | White | 1.00 (25.4) | 0.38 (9.5) | 1.10 (27.9) | 0.50 (12.7) | 7 | 24 | 8.60 (218.4) | 5000 |
| PDL-75 | B | TEDLAR | White | 1.00 (25.4) | 0.38 (9.5) | 1.10 (27.9) | 0.50 (12.7) | 7 | 24 | 8.60 (218.4) | 5000 |

*TEDLAR is the registered trademark of E. I. DuPont Co.
 †Wide carriage printer required to print this label
 ‡Order number of labels required in multiples of Std. Pkg. Qty.



PDL Blank Labels by Size (cont.)

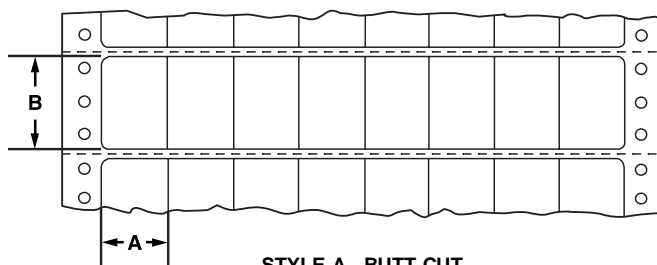

STYLE A - BUTT CUT

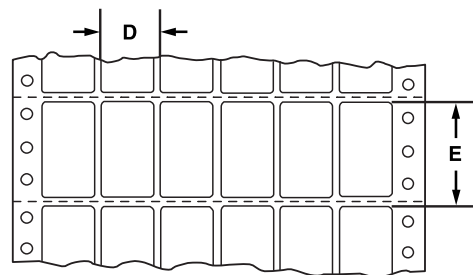

STYLE B - DIE CUT

| Part Number | Style | Material | Color | Label Width A In. (mm) | Label Length B In. (mm) | Horizontal Repeat D In. (mm) | Vertical Repeat E In. (mm) | Labels Per Row | Rows Per Fanfold | Web Width F In. (mm) | Std. Pkg. Qty.* |
|--|-------|--------------|--------|---------------------------|----------------------------|---------------------------------|-------------------------------|----------------|------------------|-------------------------|-----------------|
| PDL-19-1 | B | Vinyl Cloth | White | 1.00 (25.4) | 0.50 (12.7) | 1.10 (27.9) | 0.67 (16.9) | 7 | 18 | 8.60 (218.4) | 1000 |
| PDL-19 | B | Vinyl Cloth | White | 1.00 (25.4) | 0.50 (12.7) | 1.10 (27.9) | 0.67 (16.9) | 7 | 18 | 8.60 (218.4) | 5000 |
| PDL-19-10 | B | Vinyl Cloth | White | 1.00 (25.4) | 0.50 (12.7) | 1.10 (27.9) | 0.67 (16.9) | 7 | 18 | 8.60 (218.4) | 10,000 |
| PDL-20-1 | B | Polyester | White | 1.00 (25.4) | 0.50 (12.7) | 1.10 (27.9) | 0.67 (16.9) | 7 | 18 | 8.60 (218.4) | 1000 |
| PDL-20 | B | Polyester | White | 1.00 (25.4) | 0.50 (12.7) | 1.10 (27.9) | 0.67 (16.9) | 7 | 18 | 8.60 (218.4) | 5000 |
| PDL-20-10 | B | Polyester | White | 1.00 (25.4) | 0.50 (12.7) | 1.10 (27.9) | 0.67 (16.9) | 7 | 18 | 8.60 (218.4) | 10,000 |
| PDL-21-1 | B | Destr. Vinyl | White | 1.00 (25.4) | 0.50 (12.7) | 1.10 (27.9) | 0.67 (16.9) | 7 | 18 | 8.60 (218.4) | 1000 |
| PDL-21 | B | Destr. Vinyl | White | 1.00 (25.4) | 0.50 (12.7) | 1.10 (27.9) | 0.67 (16.9) | 7 | 18 | 8.60 (218.4) | 5000 |
| PDL-21-10 | B | Destr. Vinyl | White | 1.00 (25.4) | 0.50 (12.7) | 1.10 (27.9) | 0.67 (16.9) | 7 | 18 | 8.60 (218.4) | 10,000 |
| PDL-22-1 | B | Polyester | Silver | 1.00 (25.4) | 0.50 (12.7) | 1.10 (27.9) | 0.67 (16.9) | 7 | 18 | 8.60 (218.4) | 1000 |
| PDL-22 | B | Polyester | Silver | 1.00 (25.4) | 0.50 (12.7) | 1.10 (27.9) | 0.67 (16.9) | 7 | 18 | 8.60 (218.4) | 5000 |
| PDL-22-10 | B | Polyester | Silver | 1.00 (25.4) | 0.50 (12.7) | 1.10 (27.9) | 0.67 (16.9) | 7 | 18 | 8.60 (218.4) | 10,000 |
| PDL-65 | B | Remov. Paper | White | 1.00 (25.4) | 0.50 (12.7) | 1.10 (27.9) | 0.67 (16.9) | 7 | 18 | 8.60 (218.4) | 5000 |
| PDL-97 | B | Aluminum | Silver | 1.00 (25.4) | 0.50 (12.7) | 1.10 (27.9) | 0.67 (16.9) | 7 | 18 | 8.60 (218.4) | 5000 |
| PDL-98 | B | Polyimide | Amber | 1.00 (25.4) | 0.50 (12.7) | 1.10 (27.9) | 0.67 (16.9) | 7 | 18 | 8.60 (218.4) | 5000 |
| PDL-99 | B | TEDLAR ▲ | White | 1.00 (25.4) | 0.50 (12.7) | 1.10 (27.9) | 0.67 (16.9) | 7 | 18 | 8.60 (218.4) | 5000 |
| PDL-99-10 | B | TEDLAR | White | 1.00 (25.4) | 0.50 (12.7) | 1.10 (27.9) | 0.67 (16.9) | 7 | 18 | 8.60 (218.4) | 10,000 |
| PDL-157 | B | Polyester | White | 1.00 (25.4) | 0.50 (12.7) | 1.13 (28.7) | 0.67 (16.9) | 5 | 18 | 6.52 (165.6) | 5000 |
| PDL-158 | B | Polyester | Silver | 1.00 (25.4) | 0.50 (12.7) | 1.13 (28.7) | 0.67 (16.9) | 5 | 18 | 6.52 (165.6) | 5000 |
| PDL-188 | B | Vinyl | White | 1.00 (25.4) | 0.50 (12.7) | 1.10 (27.9) | 0.67 (16.9) | 7 | 18 | 8.60 (218.4) | 5000 |
| PDL-230 | B | TEDLAR | Yellow | 1.00 (25.4) | 0.50 (12.7) | 1.10 (27.9) | 0.67 (16.9) | 7 | 18 | 8.60 (218.4) | 5000 |
| PDL-363 | B | Polyester | Clear | 1.00 (25.4) | 0.50 (12.7) | 1.10 (27.9) | 0.67 (16.9) | 7 | 18 | 8.60 (218.4) | 5000 |
| PDL-7294-1 | B | Destr. Vinyl | White | 1.00 (25.4) | 0.50 (12.7) | 1.60 (40.6) | 0.67 (16.9) | 3 | 18 | 5.70 (144.8) | 5000 |
| PDL-288 | B | Vinyl Cloth | White | 1.00 (25.4) | 0.75 (19.1) | 1.10 (27.9) | 1.00 (25.4) | 7 | 12 | 8.60 (218.4) | 5000 |
| PDL-290 | B | TEDLAR | White | 1.00 (25.4) | 0.75 (19.1) | 1.10 (27.9) | 1.00 (25.4) | 7 | 12 | 8.60 (218.4) | 5000 |
| PDL-290-1 | B | TEDLAR | White | 1.00 (25.4) | 0.75 (19.1) | 1.10 (27.9) | 1.00 (25.4) | 7 | 12 | 8.60 (218.4) | 1000 |
| PDL-291 | A | Vinyl Cloth | White | 1.00 (25.4) | 0.94 (23.8) | 1.00 (25.4) | 1.00 (25.4) | 8 | 12 | 9.00 (228.6) | 5000 |
| PDL-293 | A | TEDLAR | White | 1.00 (25.4) | 0.94 (23.8) | 1.00 (25.4) | 1.00 (25.4) | 8 | 12 | 9.00 (228.6) | 5000 |
| PDL-294 and PDL-296 have a horizontal perforation 0.72" (18.3mm) from the top (see drawing below) | | | | | | | | | | | |
| PDL-294 | B | Vinyl Cloth | White | 1.00 (25.4) | 1.44 (36.5) | 1.10 (27.9) | 1.50 (38.1) | 7 | 8 | 8.60 (218.4) | 5000 |
| PDL-296 | B | TEDLAR | White | 1.00 (25.4) | 1.44 (36.5) | 1.10 (27.9) | 1.50 (38.1) | 7 | 8 | 8.60 (218.4) | 5000 |
| PDL-4674-1 | B | Vinyl Cloth | White | 1.13 (28.6) | 0.53 (13.5) | 1.60 (40.6) | 0.63 (15.9) | 4 | 16 | 7.30 (185.4) | 20,000 |
| PDL-4674-3 | B | TEDLAR | White | 1.13 (28.6) | 0.53 (13.5) | 1.60 (40.6) | 0.63 (15.9) | 4 | 16 | 7.30 (185.4) | 20,000 |
| PDL-4565-2 | B | TEDLAR | White | 1.18 (30.0) | 0.37 (9.5) | 1.30 (33.0) | 0.50 (12.7) | 6 | 24 | 8.62 (219.0) | 5000 |

*TEDLAR is the registered trademark of E. I. DuPont Co.
*Order number of labels required in multiples of Std. Pkg. Qty.

PDL-294
PDL-296

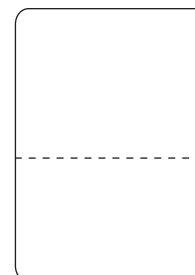

PDL Blank Labels by Size (cont.)

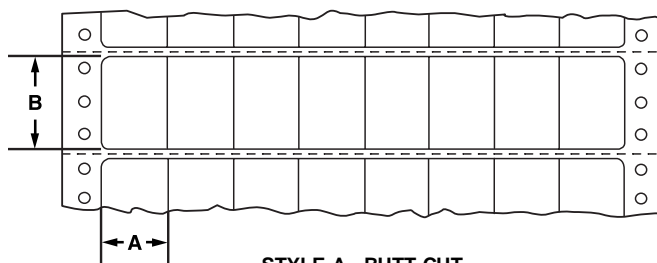

STYLE A - BUTT CUT

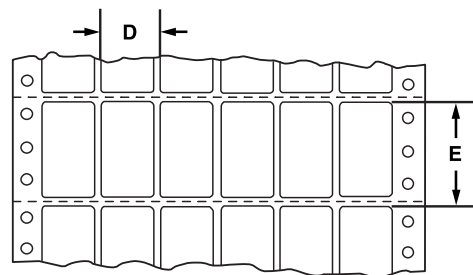

STYLE B - DIE CUT

| Part Number | Style | Material | Color | Label Width A In. (mm) | Label Length B In. (mm) | Horizontal Repeat D In. (mm) | Vertical Repeat E In. (mm) | Labels Per Row | Rows Per Fanfold | Web Width F In. (mm) | Std. Pkg. Qty.* |
|--|-------|--------------|-----------------------|---------------------------|----------------------------|---------------------------------|-------------------------------|----------------|------------------|-------------------------|-----------------|
| PDL-24 | B | TEDLAR * | Yellow | 1.25 (31.8) | 0.38 (9.5) | 1.40 (35.6) | 0.50 (12.7) | 7 | 24 | 10.75 (273.1)‡ | 5000 |
| PDL-25 | B | TEDLAR | White | 1.25 (31.8) | 0.38 (9.5) | 1.40 (35.6) | 0.50 (12.7) | 7 | 24 | 10.75 (273.1)‡ | 5000 |
| PDL-25-10 | B | TEDLAR | White | 1.25 (31.8) | 0.38 (9.5) | 1.40 (35.6) | 0.50 (12.7) | 7 | 24 | 10.75 (273.1)‡ | 10,000 |
| PDL-26 | B | TEDLAR | Silver | 1.25 (31.8) | 0.38 (9.5) | 1.40 (35.6) | 0.50 (12.7) | 7 | 24 | 10.75 (273.1)‡ | 5000 |
| PDL-69 | B | Vinyl Cloth | White | 1.25 (31.8) | 0.38 (9.5) | 1.40 (35.6) | 0.50 (12.7) | 7 | 24 | 10.75 (273.1)‡ | 5000 |
| PDL-70 | B | Destr. Paper | White | 1.25 (31.8) | 0.38 (9.5) | 1.40 (35.6) | 0.50 (12.7) | 7 | 24 | 10.75 (273.1)‡ | 5000 |
| PDL-71 | B | Polyester | White | 1.25 (31.8) | 0.38 (9.5) | 1.40 (35.6) | 0.50 (12.7) | 7 | 24 | 10.75 (273.1)‡ | 5000 |
| PDL-127 | B | TEDLAR | Yellow | 1.25 (31.8) | 0.38 (9.5) | 1.40 (35.6) | 0.50 (12.7) | 5 | 24 | 7.95 (201.9) | 5000 |
| PDL-128 | B | TEDLAR | White | 1.25 (31.8) | 0.38 (9.5) | 1.40 (35.6) | 0.50 (12.7) | 5 | 24 | 7.95 (201.9) | 5000 |
| PDL-128-10 | B | TEDLAR | White | 1.25 (31.8) | 0.38 (9.5) | 1.40 (35.6) | 0.50 (12.7) | 5 | 24 | 7.95 (201.9) | 10,000 |
| PDL-129 | B | TEDLAR | Gray | 1.25 (31.8) | 0.38 (9.5) | 1.40 (35.6) | 0.50 (12.7) | 5 | 24 | 7.95 (201.9) | 5000 |
| PDL-130 | B | Vinyl Cloth | White | 1.25 (31.8) | 0.38 (9.5) | 1.40 (35.6) | 0.50 (12.7) | 5 | 24 | 7.95 (201.9) | 5000 |
| PDL-131 | B | Polyester | White | 1.25 (31.8) | 0.38 (9.5) | 1.40 (35.6) | 0.50 (12.7) | 5 | 24 | 7.95 (201.9) | 5000 |
| PDL-132 | B | Vinyl | White | 1.25 (31.8) | 0.38 (9.5) | 1.40 (35.6) | 0.50 (12.7) | 5 | 24 | 7.95 (201.9) | 5000 |
| PDL-132-10 | B | Vinyl | White | 1.25 (31.8) | 0.38 (9.5) | 1.40 (35.6) | 0.50 (12.7) | 5 | 24 | 7.95 (201.9) | 10,000 |
| PDL-370 | B | Destr. Paper | White | 1.25 (31.8) | 0.38 (9.5) | 1.40 (35.6) | 0.50 (12.7) | 5 | 24 | 7.95 (201.9) | 5000 |
| PDL-5712-2 | B | Polyester | White with Red Border | 1.25 (31.8) | 0.38 (9.5) | 1.40 (35.6) | 0.50 (12.7) | 5 | 24 | 7.95 (201.9) | 25,000 |
| PDL-407-1 | B | Polyester | Clear | 1.38 (34.9) | 0.28 (7.1) | 1.50 (38.1) | 0.50 (12.7) | 3 | 24 | 5.38 (136.5) | 1000 |
| PDL-409-1 | B | Polyester | White | 1.38 (34.9) | 0.28 (7.1) | 1.50 (38.1) | 0.50 (12.7) | 3 | 24 | 5.38 (136.5) | 1000 |
| PDL-357 | B | Polyimide | Amber | 1.50 (38.1) | 0.25 (6.4) | 1.60 (40.6) | 0.38 (9.5) | 4 | 32 | 7.30 (185.4) | 5000 |
| PDL-358 | B | Polyester | White | 1.50 (38.1) | 0.25 (6.4) | 1.60 (40.6) | 0.38 (9.5) | 4 | 32 | 7.30 (185.4) | 5000 |
| PDL-7542-10 | B | Polyester | Silver | 1.50 (38.1) | 0.25 (6.4) | 1.60 (40.6) | 0.38 (9.5) | 4 | 32 | 7.30 (185.4) | 10,000 |
| PDL-40 thru PDL-629 have a vertical perforation 0.75" (19.1 mm) from the left (see drawing below) | | | | | | | | | | | |
| PDL-40 | B | Remov. Paper | White | 1.50 (38.1) | 0.25 (6.4) | 1.83 (46.5) | 0.33 (8.5) | 4 | 36 | 8.00 (203.2) | 5000 |
| PDL-40-10 | B | Remov. Paper | White | 1.50 (38.1) | 0.25 (6.4) | 1.83 (46.5) | 0.33 (8.5) | 4 | 36 | 8.00 (203.2) | 10,000 |
| PDL-41-1 | B | Vinyl Cloth | White | 1.50 (38.1) | 0.25 (6.4) | 1.83 (46.5) | 0.33 (8.5) | 4 | 36 | 8.00 (203.2) | 1000 |
| PDL-41 | B | Vinyl Cloth | White | 1.50 (38.1) | 0.25 (6.4) | 1.83 (46.5) | 0.33 (8.5) | 4 | 36 | 8.00 (203.2) | 5000 |
| PDL-41-10 | B | Vinyl Cloth | White | 1.50 (38.1) | 0.25 (6.4) | 1.83 (46.5) | 0.33 (8.5) | 4 | 36 | 8.00 (203.2) | 10,000 |
| PDL-86 | B | TEDLAR | White | 1.50 (38.1) | 0.25 (6.4) | 1.83 (46.5) | 0.33 (8.5) | 4 | 36 | 8.00 (203.2) | 5000 |
| PDL-87 | B | Polyester | White | 1.50 (38.1) | 0.25 (6.4) | 1.83 (46.5) | 0.33 (8.5) | 4 | 36 | 8.00 (203.2) | 5000 |
| PDL-87-10 | B | Polyester | White | 1.50 (38.1) | 0.25 (6.4) | 1.83 (46.5) | 0.33 (8.5) | 4 | 36 | 8.00 (203.2) | 10,000 |
| PDL-359-10 | B | Remov. Paper | White | 1.50 (38.1) | 0.25 (6.4) | 1.80 (45.7) | 0.33 (8.5) | 4 | 36 | 7.90 (200.7) | 10,000 |
| PDL-360-10 | B | Vinyl Cloth | White | 1.50 (38.1) | 0.25 (6.4) | 1.80 (45.7) | 0.33 (8.5) | 4 | 36 | 7.90 (200.7) | 10,000 |
| PDL-629 | B | Vinyl | White | 1.50 (38.1) | 0.25 (6.4) | 1.60 (40.6) | 0.50 (12.7) | 4 | 24 | 7.30 (185.4) | 5000 |

*TEDLAR is the registered trademark of E. I. DuPont Co.
 †Wide carriage printer required to print this label
 *Order number of labels required in multiples of Std. Pkg. Qty.

PDL-40
PDL-41
PDL-86

PDL-87
PDL-359
PDL-360
PDL-629



PDL Blank Labels by Size (cont.)

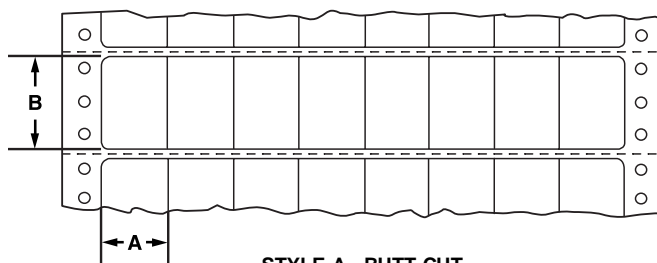

STYLE A - BUTT CUT

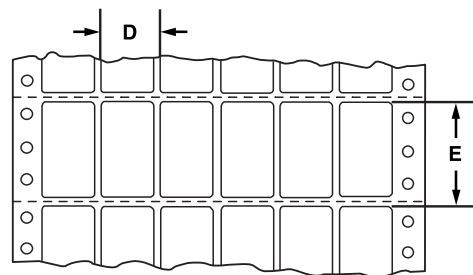

STYLE B - DIE CUT

| Part Number | Style | Material | Color | Label Width A In. (mm) | Label Length B In. (mm) | Horizontal Repeat D In. (mm) | Vertical Repeat E In. (mm) | Labels Per Row | Rows Per Fanfold | Web Width F In. (mm) | Std. Pkg. Qty.* |
|--------------|-------|---------------------|--------|---------------------------|----------------------------|---------------------------------|-------------------------------|----------------|------------------|-------------------------|---------------------|
| PDL-27 | B | TEDLAR [▲] | White | 1.50 (38.1) | 0.75 (19.1) | 1.70 (43.2) | 1.00 (25.4) | 4 | 12 | 7.6 (193.6) | 5000 |
| PDL-27-10 | B | TEDLAR | White | 1.50 (38.1) | 0.75 (19.1) | 1.70 (43.2) | 1.00 (25.4) | 4 | 12 | 7.6 (193.6) | 10,000 |
| PDL-28 | B | TEDLAR | Yellow | 1.50 (38.1) | 0.75 (19.1) | 1.70 (43.2) | 1.00 (25.4) | 4 | 12 | 7.6 (193.6) | 5000 |
| PDL-29-1 | B | Polyester | Silver | 1.50 (38.1) | 0.75 (19.1) | 1.70 (43.2) | 1.00 (25.4) | 4 | 12 | 7.6 (193.6) | 1000 |
| PDL-29 | B | Polyester | Silver | 1.50 (38.1) | 0.75 (19.1) | 1.70 (43.2) | 1.00 (25.4) | 4 | 12 | 7.6 (193.6) | 5000 |
| PDL-29-10 | B | Polyester | Silver | 1.50 (38.1) | 0.75 (19.1) | 1.70 (43.2) | 1.00 (25.4) | 4 | 12 | 7.6 (193.6) | 10,000 |
| PDL-72 | B | Vinyl Cloth | White | 1.50 (38.1) | 0.75 (19.1) | 1.70 (43.2) | 1.00 (25.4) | 4 | 12 | 7.6 (193.6) | 5000 |
| PDL-73 | B | Destr. Paper | White | 1.50 (38.1) | 0.75 (19.1) | 1.70 (43.2) | 1.00 (25.4) | 4 | 12 | 7.6 (193.6) | 5000 |
| PDL-73-10 | B | Destr. Paper | White | 1.50 (38.1) | 0.75 (19.1) | 1.70 (43.2) | 1.00 (25.4) | 4 | 12 | 7.6 (193.6) | 10,000 |
| PDL-231 | B | Polyester | White | 1.50 (38.1) | 0.75 (19.1) | 1.70 (43.2) | 1.00 (25.4) | 4 | 12 | 7.6 (193.6) | 5000 |
| PDL-231-10 | B | Polyester | White | 1.50 (38.1) | 0.75 (19.1) | 1.70 (43.2) | 1.00 (25.4) | 4 | 12 | 7.6 (193.6) | 10,000 |
| PDL-297 | B | Vinyl Cloth | Yellow | 1.50 (38.1) | 0.90 (22.9) | 1.60 (40.6) | 1.00 (25.4) | 5 | 12 | 9.00 (228.6) | 1000 |
| PDL-298 | B | Vinyl Cloth | White | 1.50 (38.1) | 0.90 (22.9) | 1.60 (40.6) | 1.00 (25.4) | 5 | 12 | 9.00 (228.6) | 1000 |
| PDL-7572-1R | A | Polyester | Silver | 1.63 (41.3) | 0.38 (9.5) | 1.63 (41.3) | 0.38 (9.5) | 5 | 2000• | 9.13 (231.9)‡ | 1000 |
| PDL-7572-10R | A | Polyester | Silver | 1.63 (41.3) | 0.38 (9.5) | 1.63 (41.3) | 0.38 (9.5) | 5 | 200• | 9.13 (231.9)‡ | 10,000 |
| PDL-408-TL | A | Semi-Rigid Vinyl | White | 1.95 (49.5) | 0.40 (10.2) | — | 0.50 (12.7) | 1 | 250• | 2.95 (74.9) | 1 Roll (250 Labels) |
| PDL-32-1 | B | Vinyl Cloth | White | 2.00 (50.8) | 0.38 (9.5) | 2.10 (53.4) | 0.50 (12.7) | 4 | 24 | 9.30 (236.2)‡ | 1000 |
| PDL-32 | B | Vinyl Cloth | White | 2.00 (50.8) | 0.38 (9.5) | 2.10 (53.4) | 0.50 (12.7) | 4 | 24 | 9.30 (236.2)‡ | 5000 |
| PDL-32-10 | B | Vinyl Cloth | White | 2.00 (50.8) | 0.38 (9.5) | 2.10 (53.4) | 0.50 (12.7) | 4 | 24 | 9.30 (236.2)‡ | 10,000 |
| PDL-76 | B | TEDLAR | White | 2.00 (50.8) | 0.38 (9.5) | 2.10 (53.4) | 0.50 (12.7) | 4 | 24 | 9.30 (236.2)‡ | 5000 |
| PDL-77 | B | Polyester | White | 2.00 (50.8) | 0.38 (9.5) | 2.10 (53.4) | 0.50 (12.7) | 4 | 24 | 9.30 (236.2)‡ | 5000 |
| PDL-78 | B | Destr. Paper | White | 2.00 (50.8) | 0.38 (9.5) | 2.10 (53.4) | 0.50 (12.7) | 4 | 24 | 9.30 (236.2)‡ | 5000 |
| PDL-110-1 | B | TEDLAR | White | 2.00 (50.8) | 0.38 (9.5) | 2.10 (53.4) | 0.50 (12.7) | 3 | 24 | 7.20 (182.9) | 1000 |
| PDL-110 | B | TEDLAR | White | 2.00 (50.8) | 0.38 (9.5) | 2.10 (53.4) | 0.50 (12.7) | 3 | 24 | 7.20 (182.9) | 5000 |
| PDL-111-1 | B | Polyester | White | 2.00 (50.8) | 0.38 (9.5) | 2.10 (53.4) | 0.50 (12.7) | 3 | 24 | 7.20 (182.9) | 1000 |
| PDL-111 | B | Polyester | White | 2.00 (50.8) | 0.38 (9.5) | 2.10 (53.4) | 0.50 (12.7) | 3 | 24 | 7.20 (182.9) | 5000 |
| PDL-112 | B | Destr. Paper | White | 2.00 (50.8) | 0.38 (9.5) | 2.10 (53.4) | 0.50 (12.7) | 3 | 24 | 7.20 (182.9) | 5000 |
| PDL-113 | B | Vinyl | White | 2.00 (50.8) | 0.38 (9.5) | 2.10 (53.4) | 0.50 (12.7) | 3 | 24 | 7.20 (182.9) | 5000 |
| PDL-114 | B | Vinyl Cloth | White | 2.00 (50.8) | 0.38 (9.5) | 2.10 (53.4) | 0.50 (12.7) | 3 | 24 | 7.20 (182.9) | 5000 |
| PDL-237 | B | Polyimide | Amber | 2.00 (50.8) | 0.38 (9.5) | 2.10 (53.4) | 0.50 (12.7) | 3 | 24 | 7.20 (182.9) | 5000 |
| PDL-7517 | B | Polyester | Silver | 2.00 (50.8) | 0.38 (9.5) | 2.10 (53.4) | 0.50 (12.7) | 4 | 24 | 9.30 (236.2)‡ | 5000 |
| PDL110G5 | B | Polyester | Clear | 2.00 (50.8) | 0.38 (9.5) | 2.10 (53.4) | 0.50 (12.7) | 3 | 24 | 7.20 (182.9) | 5000 |
| PDL-299 | B | Remov. Paper | White | 2.00 (50.8) | 0.90 (22.9) | 2.10 (53.4) | 1.00 (25.4) | 3 | 12 | 7.20 (182.9) | 1000 |
| PDL-300 | B | Destr. Paper | White | 2.00 (50.8) | 0.90 (22.9) | 2.10 (53.4) | 1.00 (25.4) | 3 | 12 | 7.20 (182.9) | 1000 |
| PDL-301 | B | Polyester | White | 2.00 (50.8) | 0.90 (22.9) | 2.10 (53.4) | 1.00 (25.4) | 3 | 12 | 7.20 (182.9) | 1000 |
| PDL-302 | B | Polyester | Silver | 2.00 (50.8) | 0.90 (22.9) | 2.10 (53.4) | 1.00 (25.4) | 3 | 12 | 7.20 (182.9) | 1000 |
| PDL-145 | B | Polyester | Silver | 2.00 (50.8) | 1.25 (31.8) | — | 1.38 (34.9) | 1 | 8 | 3.00 (76.2) | 1000 |
| PDL-146 | B | Vinyl | White | 2.00 (50.8) | 1.25 (31.8) | — | 1.38 (34.9) | 1 | 8 | 3.00 (76.2) | 1000 |
| PDL-147 | B | Vinyl Cloth | White | 2.00 (50.8) | 1.25 (31.8) | — | 1.38 (34.9) | 1 | 8 | 3.00 (76.2) | 1000 |
| PDL-148 | B | Aluminum | Silver | 2.00 (50.8) | 1.25 (31.8) | — | 1.38 (34.9) | 1 | 8 | 3.00 (76.2) | 1000 |
| PDL-149 | B | Destr. Paper | White | 2.00 (50.8) | 1.25 (31.8) | — | 1.38 (34.9) | 1 | 8 | 3.00 (76.2) | 1000 |
| PDL-150 | B | Polyester | White | 2.00 (50.8) | 1.25 (31.8) | — | 1.38 (34.9) | 1 | 8 | 3.00 (76.2) | 1000 |

[▲]TEDLAR is the registered trademark of E. I. DuPont Co.

•Indicates label is roll mounted on 3" (76.2 mm) core

‡Wide carriage printer required to print this label

*Order number of labels required in multiples of Std. Pkg. Qty. For roll mounted labels, order number of rolls required in multiples of Std. Pkg. Qty.

PDL Blank Labels by Size (cont.)

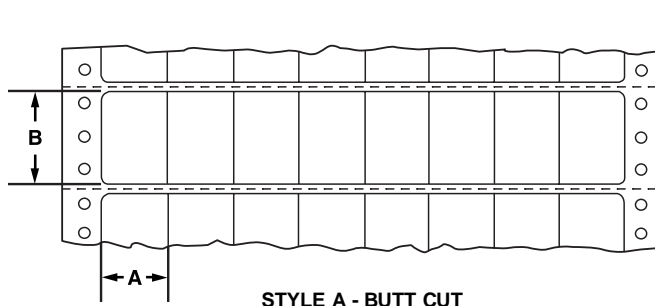

STYLE A - BUTT CUT

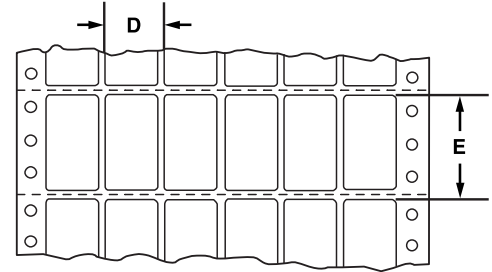

STYLE B - DIE CUT

| Part Number | Style | Material | Color | Label Width A In. (mm) | Label Length B In. (mm) | Horizontal Repeat D In. (mm) | Vertical Repeat E In. (mm) | Labels Per Row | Rows Per Fanfold | Web Width F In. (mm) | Std. Pkg. Qty.* |
|-------------|-------|------------------|--------|---------------------------|----------------------------|---------------------------------|-------------------------------|----------------|------------------|-------------------------|---------------------|
| PDL-303 | B | Remov. Paper | White | 2.00 (50.8) | 1.44 (36.5) | 2.10 (53.4) | 1.50 (38.1) | 3 | 8 | 7.20 (182.9) | 1000 |
| PDL-304 | B | Destr. Paper | White | 2.00 (50.8) | 1.44 (36.5) | 2.10 (53.4) | 1.50 (38.1) | 3 | 8 | 7.20 (182.9) | 1000 |
| PDL-305 | B | Polyester | White | 2.00 (50.8) | 1.44 (36.5) | 2.10 (53.4) | 1.50 (38.1) | 3 | 8 | 7.20 (182.9) | 1000 |
| PDL-305-10 | B | Polyester | White | 2.00 (50.8) | 1.44 (36.5) | 2.10 (53.4) | 1.50 (38.1) | 3 | 8 | 7.20 (182.9) | 10,000 |
| PDL-306 | B | Polyester | Silver | 2.00 (50.8) | 1.44 (36.5) | 2.10 (53.4) | 1.50 (38.1) | 3 | 8 | 7.20 (182.9) | 1000 |
| PDL-7557-1 | B | TEDLAR | White | 2.50 (63.5) | 4.25 (108.0) | 2.75 (69.9) | 4.50 (114.3) | 4 | 2 | 11.89 (302.0)‡ | 1000 |
| PDL-163 | B | Destr. Paper | White | 2.80 (71.1) | 1.00 (25.4) | 2.90 (73.7) | 1.13 (28.6) | 3 | 8 | 9.50 (241.3)‡ | 1000 |
| PDL-164 | B | Vinyl Cloth | White | 2.80 (71.1) | 1.00 (25.4) | 2.90 (73.7) | 1.13 (28.6) | 3 | 8 | 9.50 (241.3)‡ | 1000 |
| PDL-165 | B | Destr. Paper | White | 2.80 (71.1) | 1.50 (38.1) | 2.90 (73.7) | 1.63 (41.3) | 3 | 8 | 9.50 (241.3)‡ | 1000 |
| PDL-166 | B | Vinyl Cloth | White | 2.80 (71.1) | 1.50 (38.1) | 2.90 (73.7) | 1.63 (41.3) | 3 | 8 | 9.50 (241.3)‡ | 1000 |
| PDL-410-TL | A | Semi-Rigid Vinyl | White | 3.00 (76.2) | 0.33 (8.5) | — | 0.33 (8.5) | 1 | 250• | 4.00 (101.6) | 1 Roll (250 Labels) |
| PDL-33 | B | Vinyl Cloth | White | 3.00 (76.2) | 0.38 (9.5) | 3.10 (78.7) | 0.50 (12.7) | 2 | 24 | 7.10 (180.3) | 5000 |
| PDL-79 | B | TEDLAR | White | 3.00 (76.2) | 0.38 (9.5) | 3.10 (78.7) | 0.50 (12.7) | 2 | 24 | 7.10 (180.3) | 5000 |
| PDL-80 | B | Polyester | White | 3.00 (76.2) | 0.38 (9.5) | 3.10 (78.7) | 0.50 (12.7) | 2 | 24 | 7.10 (180.3) | 5000 |
| PDL-81 | B | Destr. Paper | White | 3.00 (76.2) | 0.38 (9.5) | 3.10 (78.7) | 0.50 (12.7) | 2 | 24 | 7.10 (180.3) | 5000 |
| PDL-232 | B | Polyimide | Amber | 3.00 (76.2) | 0.38 (9.5) | 3.10 (78.7) | 0.50 (12.7) | 2 | 24 | 7.10 (180.3) | 5000 |
| PDL-307 | B | Vinyl Cloth | Yellow | 3.00 (76.2) | 0.90 (22.9) | 3.10 (78.7) | 1.00 (25.4) | 2 | 12 | 7.10 (180.3) | 1000 |
| PDL-308 | B | Vinyl Cloth | White | 3.00 (76.2) | 0.90 (22.9) | 3.10 (78.7) | 1.00 (25.4) | 2 | 12 | 7.10 (180.3) | 1000 |
| PDL-309 | B | Remov. Paper | White | 3.00 (76.2) | 0.90 (22.9) | 3.10 (78.7) | 1.00 (25.4) | 2 | 12 | 7.10 (180.3) | 1000 |
| PDL-310 | B | Destr. Paper | White | 3.00 (76.2) | 0.90 (22.9) | 3.10 (78.7) | 1.00 (25.4) | 2 | 12 | 7.10 (180.3) | 1000 |
| PDL-311 | B | Polyester | White | 3.00 (76.2) | 0.90 (22.9) | 3.10 (78.7) | 1.00 (25.4) | 2 | 12 | 7.10 (180.3) | 1000 |
| PDL-312 | B | Polyester | Silver | 3.00 (76.2) | 0.90 (22.9) | 3.10 (78.7) | 1.00 (25.4) | 2 | 12 | 7.10 (180.3) | 1000 |
| PDL-313 | B | Remov. Paper | White | 3.00 (76.2) | 1.44 (36.5) | 3.10 (78.7) | 1.50 (38.1) | 2 | 8 | 7.10 (180.3) | 1000 |
| PDL-314 | B | Destr. Paper | White | 3.00 (76.2) | 1.44 (36.5) | 3.10 (78.7) | 1.50 (38.1) | 2 | 8 | 7.10 (180.3) | 1000 |
| PDL-315 | B | Polyester | White | 3.00 (76.2) | 1.44 (36.5) | 3.10 (78.7) | 1.50 (38.1) | 2 | 8 | 7.10 (180.3) | 1000 |
| PDL-316 | B | Polyester | Silver | 3.00 (76.2) | 1.44 (36.5) | 3.10 (78.7) | 1.50 (38.1) | 2 | 8 | 7.10 (180.3) | 1000 |
| PDL-317 | B | Remov. Paper | White | 3.00 (76.2) | 1.90 (48.3) | 3.10 (78.7) | 2.00 (50.8) | 2 | 6 | 7.10 (180.3) | 1000 |
| PDL-318 | B | Destr. Paper | White | 3.00 (76.2) | 1.90 (48.3) | 3.10 (78.7) | 2.00 (50.8) | 2 | 6 | 7.10 (180.3) | 1000 |
| PDL-319 | B | Polyester | White | 3.00 (76.2) | 1.90 (48.3) | 3.10 (78.7) | 2.00 (50.8) | 2 | 6 | 7.10 (180.3) | 1000 |
| PDL-320 | B | Polyester | Silver | 3.00 (76.2) | 1.90 (48.3) | 3.10 (78.7) | 2.00 (50.8) | 2 | 6 | 7.10 (180.3) | 1000 |
| PDL-139 | B | Polyester | Silver | 3.00 (76.2) | 2.00 (50.8) | — | 3.00 (76.2) | 1 | 4 | 4.00 (101.6) | 1000 |
| PDL-140 | B | Vinyl | White | 3.00 (76.2) | 2.00 (50.8) | — | 3.00 (76.2) | 1 | 4 | 4.00 (101.6) | 1000 |
| PDL-141 | B | Destr. Paper | White | 3.00 (76.2) | 2.00 (50.8) | — | 3.00 (76.2) | 1 | 4 | 4.00 (101.6) | 1000 |
| PDL-142 | B | Vinyl Cloth | White | 3.00 (76.2) | 2.00 (50.8) | — | 3.00 (76.2) | 1 | 4 | 4.00 (101.6) | 1000 |
| PDL-143 | B | Aluminum | Silver | 3.00 (76.2) | 2.00 (50.8) | — | 3.00 (76.2) | 1 | 4 | 4.00 (101.6) | 1000 |
| PDL-144 | B | Polyester | White | 3.00 (76.2) | 2.00 (50.8) | — | 3.00 (76.2) | 1 | 4 | 4.00 (101.6) | 1000 |
| PDL-151 | B | Polyester | Silver | 3.25 (82.6) | 1.25 (31.8) | — | 1.56 (39.7) | 1 | 8 | 4.25 (108.0) | 1000 |
| PDL-152 | B | Vinyl | White | 3.25 (82.6) | 1.25 (31.8) | — | 1.56 (39.7) | 1 | 8 | 4.25 (108.0) | 1000 |
| PDL-153 | B | Vinyl Cloth | White | 3.25 (82.6) | 1.25 (31.8) | — | 1.56 (39.7) | 1 | 8 | 4.25 (108.0) | 1000 |
| PDL-154 | B | Aluminum | Silver | 3.25 (82.6) | 1.25 (31.8) | — | 1.56 (39.7) | 1 | 8 | 4.25 (108.0) | 1000 |
| PDL-155 | B | Destr. Paper | White | 3.25 (82.6) | 1.25 (31.8) | — | 1.56 (39.7) | 1 | 8 | 4.25 (108.0) | 1000 |
| PDL-156 | B | Polyester | White | 3.25 (82.6) | 1.25 (31.8) | — | 1.56 (39.7) | 1 | 8 | 4.25 (108.0) | 1000 |

*TEDLAR is the registered trademark of E. I. DuPont Co.

‡Indicates label is roll mounted on 3" (76.2 mm) core

•Order number of labels required in multiples of Std. Pkg. Qty. For roll mounted labels, order number of rolls required in multiples of Std. Pkg. Qty.

Dot-Matrix Labeling Products

PDL Blank Labels by Size (cont.)

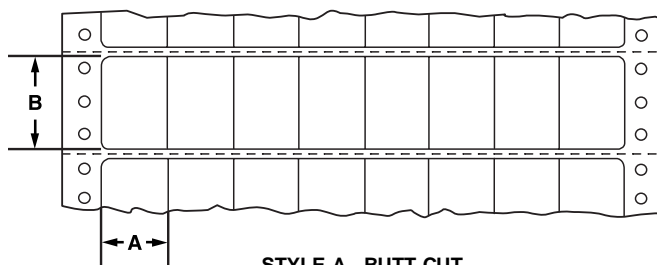

STYLE A - BUTT CUT



STYLE B - DIE CUT

| Part Number | Style | Material | Color | Label Width A In. (mm) | Label Length B In. (mm) | Horizontal Repeat D In. (mm) | Vertical Repeat E In. (mm) | Labels Per Row | Rows Per Fanfold | Web Width F In. (mm) | Std. Pkg. Qty.* |
|-------------|-------|--------------|--------|---------------------------|----------------------------|---------------------------------|-------------------------------|----------------|------------------|-------------------------|-----------------|
| PDL-159 | B | Destr. Paper | White | 3.63 (92.1) | 1.00 (25.4) | 3.73 (94.6) | 1.13 (28.6) | 2 | 8 | 8.50 (215.9) | 5000 |
| PDL-160 | B | Vinyl Cloth | White | 3.63 (92.1) | 1.00 (25.4) | 3.73 (94.6) | 1.13 (28.6) | 2 | 8 | 8.50 (215.9) | 5000 |
| PDL-161 | B | Destr. Paper | White | 3.63 (92.1) | 1.50 (38.1) | 3.73 (94.6) | 1.63 (41.3) | 2 | 8 | 8.50 (215.9) | 5000 |
| PDL-162 | B | Vinyl Cloth | White | 3.63 (92.1) | 1.50 (38.1) | 3.73 (94.6) | 1.63 (41.3) | 2 | 8 | 8.50 (215.9) | 5000 |
| PDL-321 | B | Vinyl Cloth | Yellow | 3.90 (99.1) | 0.90 (22.9) | 4.00 (101.6) | 1.00 (25.4) | 2 | 12 | 9.00 (228.6) | 1000 |
| PDL-322 | B | Vinyl Cloth | White | 3.90 (99.1) | 0.90 (22.9) | 4.00 (101.6) | 1.00 (25.4) | 2 | 12 | 9.00 (228.6) | 1000 |
| PDL-323 | B | Vinyl Cloth | White | 3.90 (99.1) | 1.44 (36.5) | 4.00 (101.6) | 1.50 (38.1) | 2 | 8 | 9.00 (228.6) | 1000 |
| PDL-324 | B | Vinyl Cloth | White | 3.90 (99.1) | 1.44 (36.5) | 4.00 (101.6) | 1.50 (38.1) | 2 | 8 | 9.00 (228.6) | 1000 |
| PDL-325 | B | Remov. Paper | White | 3.90 (99.1) | 1.44 (36.5) | 4.00 (101.6) | 1.50 (38.1) | 2 | 8 | 9.00 (228.6) | 1000 |
| PDL-326 | B | Destr. Paper | White | 3.90 (99.1) | 1.44 (36.5) | 4.00 (101.6) | 1.50 (38.1) | 2 | 8 | 9.00 (228.6) | 1000 |
| PDL-327 | B | Polyester | White | 3.90 (99.1) | 1.44 (36.5) | 4.00 (101.6) | 1.50 (38.1) | 2 | 8 | 9.00 (228.6) | 1000 |
| PDL-328 | B | Polyester | Silver | 3.90 (99.1) | 1.44 (36.5) | 4.00 (101.6) | 1.50 (38.1) | 2 | 8 | 9.00 (228.6) | 1000 |
| PDL-329 | B | Vinyl Cloth | Yellow | 3.90 (99.1) | 2.90 (73.7) | 4.00 (101.6) | 3.00 (76.2) | 2 | 4 | 9.00 (228.6) | 1000 |
| PDL-330 | B | Vinyl Cloth | White | 3.90 (99.1) | 2.90 (73.7) | 4.00 (101.6) | 3.00 (76.2) | 2 | 4 | 9.00 (228.6) | 1000 |
| PDL-331 | B | Vinyl Cloth | Yellow | 6.00 (152.4) | 0.90 (22.9) | — | 1.00 (25.4) | 1 | 12 | 7.10 (180.3) | 1000 |
| PDL-332 | B | Vinyl Cloth | White | 6.00 (152.4) | 0.90 (22.9) | — | 1.00 (25.4) | 1 | 12 | 7.10 (180.3) | 1000 |
| PDL-333 | B | Vinyl Cloth | Yellow | 6.00 (152.4) | 1.44 (36.6) | — | 1.50 (38.1) | 1 | 8 | 7.10 (180.3) | 1000 |
| PDL-334 | B | Vinyl Cloth | White | 6.00 (152.4) | 1.44 (36.6) | — | 1.50 (38.1) | 1 | 8 | 7.10 (180.3) | 1000 |
| PDL-335 | B | Vinyl Cloth | Yellow | 6.00 (152.4) | 1.90 (48.3) | — | 2.00 (50.8) | 1 | 6 | 7.10 (180.3) | 1000 |
| PDL-336 | B | Vinyl Cloth | White | 6.00 (152.4) | 1.90 (48.3) | — | 2.00 (50.8) | 1 | 6 | 7.10 (180.3) | 1000 |
| PDL-337 | B | Vinyl Cloth | Yellow | 6.00 (152.4) | 2.90 (73.7) | — | 3.00 (76.2) | 1 | 4 | 7.10 (180.3) | 1000 |
| PDL-338 | B | Vinyl Cloth | White | 6.00 (152.4) | 2.90 (73.7) | — | 3.00 (76.2) | 1 | 4 | 7.10 (180.3) | 1000 |
| PDL-339 | B | Remov. Paper | White | 6.00 (152.4) | 3.94 (100.0) | — | 4.00 (101.6) | 1 | 3 | 7.10 (180.3) | 1000 |
| PDL-340 | B | Destr. Paper | White | 6.00 (152.4) | 3.94 (100.0) | — | 4.00 (101.6) | 1 | 3 | 7.10 (180.3) | 1000 |
| PDL-403-1 | B | Polyester | White | 7.50 (190.5) | 0.50 (12.7) | — | 0.50 (12.7) | 1 | 1000• | 8.50 (215.9) | 1000 |
| PDL-403-1B | B | Polyester | Blue | 7.50 (190.5) | 0.50 (12.7) | — | 0.50 (12.7) | 1 | 1000• | 8.50 (215.9) | 1000 |
| PDL-403-1BR | B | Polyester | Brown | 7.50 (190.5) | 0.50 (12.7) | — | 0.50 (12.7) | 1 | 1000• | 8.50 (215.9) | 1000 |
| PDL-403-1G | B | Polyester | Green | 7.50 (190.5) | 0.50 (12.7) | — | 0.50 (12.7) | 1 | 1000• | 8.50 (215.9) | 1000 |
| PDL-403-1GR | B | Polyester | Gray | 7.50 (190.5) | 0.50 (12.7) | — | 0.50 (12.7) | 1 | 1000• | 8.50 (215.9) | 1000 |
| PDL-403-1OR | B | Polyester | Orange | 7.50 (190.5) | 0.50 (12.7) | — | 0.50 (12.7) | 1 | 1000• | 8.50 (215.9) | 1000 |
| PDL-403-1PR | B | Polyester | Purple | 7.50 (190.5) | 0.50 (12.7) | — | 0.50 (12.7) | 1 | 1000• | 8.50 (215.9) | 1000 |
| PDL-403-1R | B | Polyester | Red | 7.50 (190.5) | 0.50 (12.7) | — | 0.50 (12.7) | 1 | 1000• | 8.50 (215.9) | 1000 |
| PDL-403-1Y | B | Polyester | Yellow | 7.50 (190.5) | 0.50 (12.7) | — | 0.50 (12.7) | 1 | 1000• | 8.50 (215.9) | 1000 |
| PDL-403-2.5 | B | Polyester | White | 7.50 (190.5) | 0.50 (12.7) | — | 0.50 (12.7) | 1 | 2500• | 8.50 (215.9) | 2500 |
| PDL-404-1 | B | Polyester | Clear | 7.50 (190.5) | 0.50 (12.7) | — | 0.50 (12.7) | 1 | 1000• | 8.50 (215.9) | 1000 |
| PDL-404-2.5 | B | Polyester | Clear | 7.50 (190.5) | 0.50 (12.7) | — | 0.50 (12.7) | 1 | 2500• | 8.50 (215.9) | 2500 |
| PDL-341 | B | Vinyl Cloth | Yellow | 8.00 (203.2) | 1.44 (36.5) | — | 1.50 (38.1) | 1 | 8 | 9.00 (228.6) | 1000 |
| PDL-342 | B | Vinyl Cloth | White | 8.00 (203.2) | 1.44 (36.5) | — | 1.50 (38.1) | 1 | 8 | 9.00 (228.6) | 1000 |
| PDL-343 | B | Vinyl Cloth | Yellow | 12.00 (304.8) | 1.90 (48.3) | — | 2.00 (50.8) | 1 | 6 | 13.00 (330.2)‡ | 1000 |
| PDL-344 | B | Vinyl Cloth | White | 12.00 (304.8) | 1.90 (48.3) | — | 2.00 (50.8) | 1 | 6 | 13.00 (330.2)‡ | 1000 |
| PDL-345 | B | Vinyl Cloth | Yellow | 12.00 (304.8) | 2.90 (73.7) | — | 3.00 (76.2) | 1 | 4 | 13.00 (330.2)‡ | 1000 |
| PDL-346 | B | Vinyl Cloth | White | 12.00 (304.8) | 2.90 (73.7) | — | 3.00 (76.2) | 1 | 4 | 13.00 (330.2)‡ | 1000 |

‡Wide carriage printer required to print this label
 •Indicates label is roll mounted on 3" (76.2 mm) core
 *Order number of labels required in multiples of Std. Pkg. Qty.

Heat Shrink Data Label Kits



- System allows the user to prepare, with their own computer, whatever information is required to identify wire or cables up to ½" (12.7 mm) diameter, *without the use of special printers or materials.*
- Provided in every kit are 1000 clear tubes, 1½" (38.1 mm) long and 1000 dot-matrix labels listed below

Selection:

1. Measure outside diameter of wire to be marked or determine the wire gauge
2. Select the part number based on the chart below.
3. Order from your local Panduit distributor
4. Print the label using any Panduit software program
5. Apply label to wire
6. Slip on heat shrink tubing
7. Apply heat from any standard heat gun. Shrink ratio is 2:1

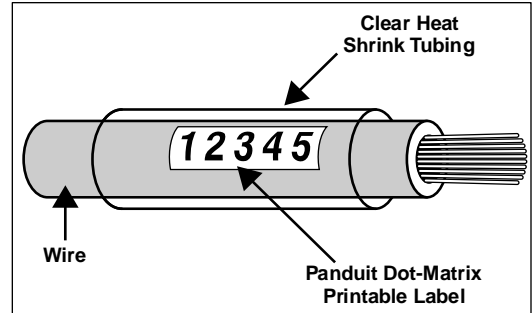

| Part Number | Label Size Width x Length In. (mm) | For Wire Range | Kit Contents | | | |
|---------------|--|-------------------|--|------|--------------------|----------------------|
| | | | Heat Shrink Sleeve Minimum Expanded Tubing Inside Diameter In. (mm) | Qty. | Labels Included | Std Pkg. Qty.* |
| HSDL9-12-94 | 0.90 x 0.25 (22.9 x 6.3) | 16 to 22 AWG | 0.13 (3.2) | 1000 | PDL-94 | 1000 Kits |
| HSDL9-12-285 | 0.90 x 0.25 (22.9 x 6.3) | 16 to 22 AWG | 0.13 (3.2) | 1000 | PDL-285 | 1000 Kits |
| HSDL9-25-94 | 0.90 x 0.25 (22.9 x 6.3) | 10 to 12 AWG | 0.25 (6.3) | 1000 | PDL-94 | 1000 Kits |
| HSDL9-25-285 | 0.90 x 0.25 (22.9 x 6.3) | 10 to 12 AWG | 0.25 (6.3) | 1000 | PDL-285 | 1000 Kits |
| HSDL9-37-31 | 1.00 x 0.38 (25.4 x 9.5) | 4 to 10 AWG | 0.35 (8.9) | 1000 | PDL-31 | 1000 Kits |
| HSDL9-50-31 | 1.00 x 0.38 (25.4 x 9.5) | 2 to 8 AWG | 0.50 (12.7) | 1000 | PDL-31 | 1000 Kits |
| HSDL9-75-20 | 1.00 x 0.38 (25.4 x 9.5) | 4/0 to 3 AWG | 0.75 (19.1) | 1000 | PDL-20 | 1000 Kits |
| HSDL9-100-293 | 1.00 x 0.38 (25.4 x 9.5) | 1/0 to 1 AWG | 1.00 (25.4) | 1000 | PDL-293 | 1000 Kits |

□ 14 AWG wire Type THW, use HSDL9-25-94 or -285

□ 14 AWG wire Type THNN, use HSDL9-12-94 or -285

*Order number of label kits required in multiples of Std. Pkg. Qty.

PAN-SHRINK Heat Shrink Tools and Accessories

- For use with all Panduit Heat Shrink Markers
- Other Heat Shrink Tools and replacement parts available. Contact factory for details.



| Part Number | Description | Std. Pkg. Qty.* |
|--------------|--|-----------------|
| HSG-115V-500 | General Purpose Tool – Air intake regulator varies temperature from 500°F (260°C) to 620°F (344°C), 115 V/dt, 11 AMP. Neoprene jacketed cord with molded strain relief | 1 |
| HSG-115V-300 | Low Temperature Tool – For use on small sizes of heat shrink when under or near heat sensitive items. Air intake regulator varies temperature from 300°F (145°C) to 450°F (232°C), 115 Volt, 8 AMP. Neoprene jacketed cord with molded strain relief | 1 |
| HSG-A1 | Shrink tube reflector for tubing up to 0.75" (19.1 mm) inside diameter – Directs heat around the tubing to reduce shrink time. | 1 |
| HSG-A2 | Shrink tube reflector for tubing up to 1.50" (38.1 mm) inside diameter – Directs heat around the tubing to reduce shrink time. | 1 |
| HSG-A3 | Shrink tube concentrator – Directs heat toward tubing and away from heat sensitive items. | 1 |
| HSG-A4 | Black polyethylene case – Stores heat tool, stand and all three accessories. | 1 |

*Order number of heat shrink accessories required in multiples of Std. Pkg. Qty.

Dot-Matrix Data Plates (PDP) - Introduction

Panduit Data Plates are non-adhesive tags used to mark wires, cables, equipment, inventory and many applications where an adhesive label is not the best solution.

- Choose from 12 different sizes, 3 materials and 2 styles
- Materials offer three different grades of strength and durability
- Can also be marked with Panduit Permanent Marking Pens (see [pg. 101](#))

Suggested Applications for Dot-Matrix Data Plates



Identify wires, cables or equipment requiring removable and reusable information

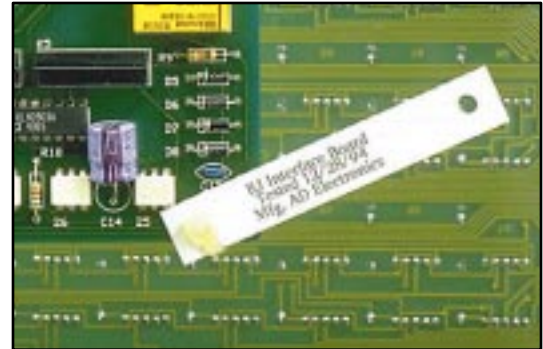

Tag equipment



Tag large bundles of cables or cables with large diameters



Identify harness board assemblies



Use on cables or wires that are constantly being bent or moved



Use to warn or inform

PDP Data Plate Labels - Drawings and Specifications

Choose the material that best suits your application:

| Material Code | Material Type | Temperature Range | Key Features | Color | Outdoor Rated | Hazardous Environment | UL Rec. | CSA |
|---------------|-------------------------|---------------------------------|--|-------|---------------|-----------------------|---------|-----|
| GMH1 | Polyester/Polycarbonate | -40°F to 250°F (-40°C to 121°C) | Semi-rigid non-adhesive film with excellent strength properties and flame resistance | White | Yes | Yes | No | No |
| GMY1 | Polyester | -40°F to 185°F (-40°C to 85°C) | Semi-rigid non-adhesive film with excellent strength and durability | White | Yes | Yes | No | No |
| GMV9 | Vinyl | -20°F to 176°F (-29°C to 80°C) | Semi-rigid non-adhesive film for flexible tags with limited tensile strength | White | No | Yes | No | No |

PDP Data Plate Labels— Drawings and Specifications

Style A

With detachable pinfeed strip and a pre-cut mounting hole for Standard Cross Section Cable Ties

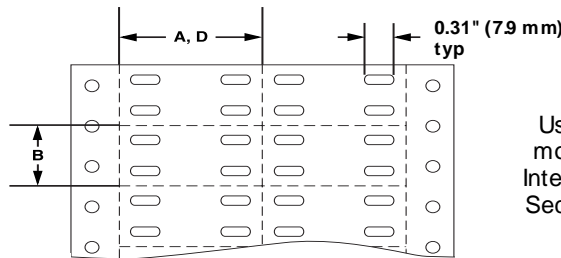

Style B

Uses pinfeed as mounting hole for Intermediate Cross Section Cable Ties

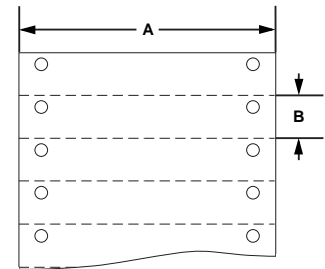

| Part Number | Style | Material | Color | Tag Width A In. (mm) | Tag Length † B In. (mm) | Horizontal Repeat D In. (mm) | Labels Per Row | Roll Width In. (mm) | Labels Per Roll | Use with Panduit Cable Tie | Std. Pkg. Qty.* |
|-------------|-------|--------------------------|-------|----------------------|-------------------------|------------------------------|----------------|---------------------|-----------------|----------------------------|-----------------|
| PDP-3 | A | Polyester/Poly carbonate | White | 1.50 (38.1) | 0.75 (19.1) | 1.50 (38.1) | 2 | 4.00 (101.6) | 500 | PLT•S-L0 | 1 Roll |
| PDP-15 | A | Polyester | White | 1.50 (38.1) | 0.75 (19.1) | 1.50 (38.1) | 2 | 4.00 (101.6) | 500 | PLT•S-L0 | 1 Roll |
| PDP-27 | A | Vinyl | White | 1.50 (38.1) | 0.75 (19.1) | 1.50 (38.1) | 2 | 4.00 (101.6) | 500 | PLT•S-C | 1 Roll |
| PDP-4 | A | Polyester/Poly carbonate | White | 1.75 (44.5) | 0.75 (19.1) | 1.75 (44.5) | 2 | 4.5 (114.3) | 500 | PLT•S-L0 | 1 Roll |
| PDP-16 | A | Polyester | White | 1.75 (44.5) | 0.75 (19.1) | 1.75 (44.5) | 2 | 4.5 (114.3) | 500 | PLT•S-L0 | 1 Roll |
| PDP-28 | A | Vinyl | White | 1.75 (44.5) | 0.75 (19.1) | 1.75 (44.5) | 2 | 4.5 (114.3) | 500 | PLT•S-C | 1 Roll |
| PDP-6 | A | Polyester/Poly carbonate | White | 2.00 (50.8) | 0.50 (12.7) | 2.00 (50.8) | 2 | 5.00 (127.0) | 500 | PLT•S-L0 | 1 Roll |
| PDP-18 | A | Polyester | White | 2.00 (50.8) | 0.50 (12.7) | 2.00 (50.8) | 2 | 5.00 (127.0) | 500 | PLT•S-L0 | 1 Roll |
| PDP-30 | A | Vinyl | White | 2.00 (50.8) | 0.50 (12.7) | 2.00 (50.8) | 2 | 5.00 (127.0) | 500 | PLT•S-C | 1 Roll |
| PDP-5 | A | Polyester/Poly carbonate | White | 2.00 (50.8) | 0.75 (19.1) | 2.00 (50.8) | 2 | 5.00 (127.0) | 500 | PLT•S-L0 | 1 Roll |
| PDP-17 | A | Polyester | White | 2.00 (50.8) | 0.75 (19.1) | 2.00 (50.8) | 2 | 5.00 (127.0) | 500 | PLT•S-L0 | 1 Roll |
| PDP-29 | A | Vinyl | White | 2.00 (50.8) | 0.75 (19.1) | 2.00 (50.8) | 2 | 5.00 (127.0) | 500 | PLT•S-C | 1 Roll |
| PDP-7 | A | Polyester/Poly carbonate | White | 2.50 (63.5) | 0.75 (19.1) | 2.50 (63.5) | 2 | 6.00 (152.4) | 500 | PLT•S-L0 | 1 Roll |
| PDP-19 | A | Polyester | White | 2.50 (63.5) | 0.75 (19.1) | 2.50 (63.5) | 2 | 6.00 (152.4) | 500 | PLT•S-L0 | 1 Roll |
| PDP-31 | A | Vinyl | White | 2.50 (63.5) | 0.75 (19.1) | 2.50 (63.5) | 2 | 6.00 (152.4) | 500 | PLT•S-C | 1 Roll |
| PDP-8 | B | Polyester/Poly carbonate | White | 3.00 (76.2) | 0.50 (12.7) | NA | 1 | 3.00 (76.2) | 500 | PLT•I-C0 | 1 Roll |
| PDP-20 | B | Polyester | White | 3.00 (76.2) | 0.50 (12.7) | NA | 1 | 3.00 (76.2) | 500 | PLT•I-C0 | 1 Roll |
| PDP-32 | B | Vinyl | White | 3.00 (76.2) | 0.50 (12.7) | NA | 1 | 3.00 (76.2) | 500 | PLT•I-C | 1 Roll |
| PDP-9 | B | Polyester/Poly carbonate | White | 3.00 (76.2) | 1.00 (25.4) | NA | 1 | 3.00 (76.2) | 500 | PLT•I-C0 | 1 Roll |
| PDP-21 | B | Polyester | White | 3.00 (76.2) | 1.00 (25.4) | NA | 1 | 3.00 (76.2) | 500 | PLT•I-C0 | 1 Roll |
| PDP-33 | B | Vinyl | White | 3.00 (76.2) | 1.00 (25.4) | NA | 1 | 3.00 (76.2) | 500 | PLT•I-C | 1 Roll |
| PDP-10 | B | Polyester/Poly carbonate | White | 3.00 (76.2) | 1.50 (38.1) | NA | 1 | 3.00 (76.2) | 500 | PLT•I-C0 | 1 Roll |
| PDP-22 | B | Polyester | White | 3.00 (76.2) | 1.50 (38.1) | NA | 1 | 3.00 (76.2) | 500 | PLT•I-C0 | 1 Roll |
| PDP-34 | B | Vinyl | White | 3.00 (76.2) | 1.50 (38.1) | NA | 1 | 3.00 (76.2) | 500 | PLT•I-C | 1 Roll |
| PDP-11 | B | Polyester/Poly carbonate | White | 3.00 (76.2) | 2.00 (50.8) | NA | 1 | 3.00 (76.2) | 500 | PLT•I-C0 | 1 Roll |
| PDP-23 | B | Polyester | White | 3.00 (76.2) | 2.00 (50.8) | NA | 1 | 3.00 (76.2) | 500 | PLT•I-C0 | 1 Roll |
| PDP-35 | B | Vinyl | White | 3.00 (76.2) | 2.00 (50.8) | NA | 1 | 3.00 (76.2) | 500 | PLT•I-C | 1 Roll |
| PDP-12 | B | Polyester/Poly carbonate | White | 3.50 (88.9) | 2.50 (63.5) | NA | 1 | 3.50 (88.9) | 500 | PLT•I-C0 | 1 Roll |
| PDP-24 | B | Polyester | White | 3.50 (88.9) | 2.50 (63.5) | NA | 1 | 3.50 (88.9) | 500 | PLT•I-C0 | 1 Roll |
| PDP-36 | B | Vinyl | White | 3.50 (88.9) | 2.50 (63.5) | NA | 1 | 3.50 (88.9) | 500 | PLT•I-C | 1 Roll |
| PDP-1 | A | Polyester/Poly carbonate | White | 4.00 (101.6) | 0.75 (19.1) | NA | 1 | 5.00 (127.0) | 500 | PLT•S-L0 | 1 Roll |
| PDP-13 | A | Polyester | White | 4.00 (101.6) | 0.75 (19.1) | NA | 1 | 5.00 (127.0) | 500 | PLT•S-L0 | 1 Roll |
| PDP-25 | A | Vinyl | White | 4.00 (101.6) | 0.75 (19.1) | NA | 1 | 5.00 (127.0) | 500 | PLT•S-C | 1 Roll |
| PDP-2 | A | Polyester/Poly carbonate | White | 4.00 (101.6) | 1.50 (38.1) | NA | 1 | 5.00 (127.0) | 500 | PLT•S-L0 | 1 Roll |
| PDP-14 | A | Polyester | White | 4.00 (101.6) | 1.50 (38.1) | NA | 1 | 5.00 (127.0) | 500 | PLT•S-L0 | 1 Roll |
| PDP-26 | A | Vinyl | White | 4.00 (101.6) | 1.50 (38.1) | NA | 1 | 5.00 (127.0) | 500 | PLT•S-C | 1 Roll |

†Tag length equals vertical repeat

*Indicates any length tie can be used. Also, Flame Retardant Ties can be substituted

*Order number of rolls required in multiples of Std. Pkg. Qty.

Dot-Matrix Indelible Ink Ribbons (PDLR) - Introduction



Panduit Data Label Ribbons are designed to give you the security of knowing that your printed legend will not fade over a short period of time. The aggressive ink is designed for use on non-porous materials to eliminate smearing and on any material that is subjected to UV rays.

PDLR's are quick drying, abrasion resistant and have excellent UV resistance. Drying speed of ink will vary depending on the material top coating and the amount of ink put on the surface. PDLR's will dry on most surfaces within 5 to 30 minutes.

Suggested Applications for Dot-Matrix Indelible Ink Ribbons



Use in high temperature applications such as Electronics Labeling

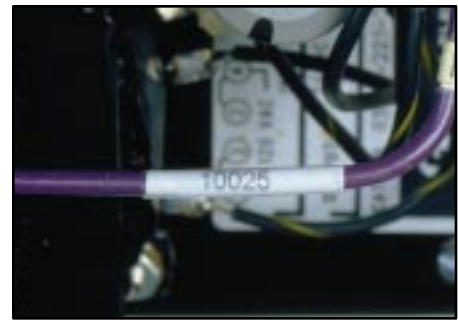

Immediately apply self-laminating labels



Security concerns



Outdoor applications



Permanently tag



Identify in harsh environments or where chemical resistance is a factor

Indelible Ink Ribbons by Printer Model

- Choose from over 59 ribbons which accommodate over 300 different printer models
- Panduit can also supply custom ribbons for printers not shown. Contact factory for details.

| Printer—Model | Part Number |
|--|-------------|
| A | |
| APPLE A9-M0310 AT T 473 | PDLR-1 |
| B | |
| BRADY WRITER B2 | PDLR-5 |
| BROTHER HR15 BROTHER HR20 BROTHER HR25 | PDLR-7 |
| BROTHER M1509 BROTHER M1709 | PDLR-6 |
| BURROUGHS 800/L9000 | PDLR-9 |
| C | |
| CENTRONIX 100/101/102/103 | PDLR-9 |
| CENTRONIX H136A/H80136 | PDLR-10 |
| CITIZEN 120D CITIZEN 180D CITIZEN GSX-140 | PDLR-12 |
| CITIZEN MPS10 CITIZEN MST10 CITIZEN MST40 | PDLR-13 |
| CITIZEN MSP15 | PDLR-17 |
| CITOH PC 8020A CITOH PC 1550 CITOH PC 8510 CITOH PC 8500 | PDLR-1 |
| COMMODORE MPP1361 | PDLR-37 |
| COMREX 420 | PDLR-317 |
| D | |
| DEC 3 (DECWRITER III) DEC LA 120/180 DEC LS 120/180 | PDLR-41 |
| DEC LA30/36 (DECWRITER) DEC LA 35/40/80 | PDLR-45 |
| DEC LA34/38/100/200 DEC 4 (DECWRITER IV) | PDLR-57 |
| DIABLO (HYTYPE II) | PDLR-61 |
| DIABLO S-11 | PDLR-65 |
| E | |
| EPSON 3210 EPSON FX70/80/82/85/86/86E EPSON FX800/850/870 EPSON LX300 EPSON MX/RX 70/80/82/85/86/86E EPSON GX80 ER C-08 | PDLR-13 |
| EPSON 8755 EPSON EX100/LX100 EPSON MX100/PX100/RX100 EPSON FX100/FX105/FX185 EPSON RX286E/286 EPSON FX1000/FX1050 EPSON FX1170 | PDLR-17 |
| EPSON EX800/1000 | PDLR-81 |
| EPSON LQ1000/1010/1050 EPSON LQ 1070/1170 | PDLR-109 |
| EPSON LQ1000/LQ1050 SILVER | PDLR-109S |
| EPSON LQ1000/LQ1050 WHITE | PDLR-109W |
| EPSON LQ500/570+ EPSON LQ800/850/870 | PDLR-113 |

| Printer—Model | Part Number |
|--|-------------|
| E (cont.) | |
| EPSON LX80/86/90 EPSON HOMEWRITER 10 EPSON SPECTRUM LX80/90 | PDLR-117 |
| EPSON LQ950 | PDLR-130 |
| EPSON LQ2500/2550 | PDLR-134 |
| EPSON LQ1500 | PDLR-135 |
| F | |
| FACIT 3100 | PDLR-1 |
| FACIT 1299095 FACIT 1850 FACIT 86HY | PDLR-133 |
| FACIT 4510/4511 | PDLR-141 |
| FACIT 4512/4512-B FACIT 2301/4514 | PDLR-145 |
| G | |
| GRAPHIC 5152-002 | PDLR-13 |
| H | |
| HEWLETT PACKARD 82-906A HEWLETT PACKARD 92156 | PDLR-13 |
| I | |
| INTACS 4200 | PDLR-45 |
| IBM 5152 | PDLR-13 |
| IBM SELECTRIC II | PDLR-133 |
| IBM PROPRINTER 4202/4208-24 IBM PROPRINTER XL24/XL24E | PDLR-161 |
| IBM3262/A1/B1 IBM5262 SYSTEM 38 | PDLR-165 |
| IBM3131 IBM3715 IBM4376-Q1L IBM3281-C1,3287 IBM3621/45 | PDLR-169 |
| IBM 3770/72/76/90 (HARMONICA) IBM 3200/3288 IBM 4715/4972/4973 | PDLR-170 |
| IBM PROPRINTER 4201 IBM PROPRINTER 4207-24 IBM PROPRINTER X24/X24E | PDLR-173 |
| IBM 4202 XL PROPRINTER | PDLR-177 |
| IBM 4224 MOD IE2/101/102 | PDLR-181 |
| IBM 5211 | PDLR-189 |
| IBM 5250 | PDLR-190 |
| IBM PROPRINTER 4201 | PDLR-193 |
| IBM SEL. III 210 BICYCLE | PDLR-205 |
| M | |
| MANNESMAN 786 6N529-0 | PDLR-45 |
| MANNESMAN TALLY 1000 | PDLR-65 |
| MANNESMAN TALLY 85 MANNESMAN TALLY 87 | PDLR-206 |
| MANNESMAN TALLY 86 MANNESMAN TALLY 88 | PDLR-207 |
| MANNESMAN TALLY 100 MANNESMAN TALLY 110 MANNESMAN TALLY 160L | PDLR-212 |

Indelible Ink Ribbons by Printer Model (cont.)

| Printer—Model | Part Number |
|--|-------------|
| M (cont.) | |
| MANNESMAN TALLY 290 MANNESMAN TALLY 130/140/180L | PDLR-215 |
| MANNESMAN TALLY MT230/MT330 | PDLR-338 |
| MM TALLY 1000 (SMALL MOUTH) | PDLR-225 |
| MITSUBISHI DX 180W | PDLR-17 |
| N | |
| NEC 8023A/8023A | PDLR-1 |
| NEC 2200P2200 | PDLR-233 |
| NEC 5200/5300/6300 P6+/P9300 | PDLR-237 |
| NEC PIN WRITER 1/2/6 (80 COLUMN) | PDLR-249 |
| NEC PIN WRITER 3/7 (136 COLUMN) | PDLR-253 |
| NEC PIN WRITER P5/XL/560/565 NEC PIN WRITER 9/960/965 | PDLR-257 |
| O | |
| OKIDATA 292 | PDLR-5 |
| OKIDATA 172/182/183 OKIDATA 192/193 OKIDATA 320/321 | PDLR-261 |
| OKIDATA 293/294 | PDLR-273 |
| OKIDATA 380/390 OKIDATA 391/391 PLUS | PDLR-279 |
| OKIDATA 80A/82A/83A OKIDATA 92/93 | PDLR-281 |
| OKIDATA 393/393 PLUS | PDLR-282 |
| OKIDATA 84/94 | PDLR-285 |
| OLYMPIA NP136 | PDLR-17 |
| OLMETTI ET 225 | PDLR-287 |
| P | |
| PANASONIC KXP 1080/1081 PANASONIC KXP 1080i | PDLR-292 |
| PANASONIC KXP 1090/1091/1092 PANASONIC KXP 2023 | PDLR-293 |
| PANASONIC KXP 1123/1124 | PDLR-297 |
| PANASONIC KXP 1150 PANASONIC KXP 1180 PANASONIC KXP 1190/1191 | PDLR-298 |
| PANASONIC KXP 1592 PANASONIC KXP 1593 PANASONIC KXP 1595 | PDLR-301 |
| PANASONIC KXP 1524/1540 PANASONIC KXP 1624 PANASONIC KXP 2624 | PDLR-302 |
| PRINTRONIX P150 PRINTRONIX P300 PRINTRONIX P600 | PDLR-305 |
| R | |
| REMINGTON ELECTRIC 101 | PDLR-133 |
| S | |
| SATA M-4500 | PDLR-45 |
| SEKOSHA 5420 | PDLR-317 |
| SIEMENS PT-88 | PDLR-13 |
| STAR SG10 | PDLR-281 |
| STAR DP834 | PDLR-337 |
| STAR MICRONICS NB 24-15 STAR MICRONICS NB 15/24 | PDLR-330 |
| STAR MICRONICS LC10 STAR MICRONICS NX 1000 | PDLR-325 |
| STAR MICRONICS NL10 STAR MICRONICS NB 24-10 STAR MICRONICS NX10/ND10 | PDLR-329 |
| STAR MICRONICS SD-15 | PDLR-336 |

| Printer—Model | Part Number |
|---|-------------|
| T | |
| TECH3 | PDLR-133 |
| TOSHIBA P1340/1350/1360 TOSHIBA P321/341/351 | PDLR-333 |
| X | |
| XEROX 1750 | PDLR-61 |

Computer Printable Labels Used With PANDUIT Marker Ties and Marker Plates



- Marker ties fasten and identify all types of wire and cable bundles at the same time
- Standard label sizes fit Panduit Marker Ties and Marker Plates for easy installation and identification
- Label, tie and marker materials available for indoor/outdoor applications



MARKER TIES - Nylon 6.6 (Indoor Use)†

| Part Number | Marker Type | Marking Area Size Width x Length In. (mm) | Length In. (mm) | Width In. (mm) | Maximum Bundle Diameter In. (mm) | Std. Pkg. Qty.* |
|-------------|-------------|---|--------------------|-------------------|---|-----------------------|
| PLM1M-C | Wrap | 0.26 x 0.95 (6.6 x 24.1) | 3.9 (99) | 0.10 (2.5) | 0.75 (19.1) | 100 |
| PLM2M-C | Wrap | 0.26 x 0.95 (6.6 x 24.1) | 8.0 (203) | 0.10 (2.5) | 2.00 (50.8) | 100 |
| PLF1M-C | Flag | 0.75 x 0.31 (19.1 x 7.9) | 4.3 (109) | 0.10 (2.5) | 0.87 (22.1) | 100 |
| PLF1MA-C | Flag | 0.76 x 1.04 (19.3 x 26.4) | 5.1 (130) | 0.10 (2.5) | 0.87 (22.1) | 100 |
| PLF1MB-C | Flag | 0.92 x 0.31 (23.4 x 7.9) | 4.0 (102) | 0.10 (2.5) | 0.75 (19.1) | 100 |
| PLM2S-C | Wrap | 0.44 x 0.87 (11.2 x 22.1) | 7.4 (188) | 0.19 (4.8) | 1.75 (44.5) | 100 |
| PLM4S-C | Wrap | 0.44 x 2.00 (11.2 x 50.8) | 14.6 (371) | 0.19 (4.8) | 4.00 (101.6) | 100 |
| PL2M2S-L | Wrap | 0.87 x 1.07 (22.1 x 27.2) | 7.4 (188) | 0.19 (4.8) | 1.75 (44.5) | 50 |
| PL3M2S-L | Wrap | 0.87 x 1.79 (22.1 x 45.5) | 7.4 (188) | 0.19 (4.8) | 1.75 (44.5) | 50 |

*Order number of ties required in multiples of Standard Package Quantity.
†For Weather Resistant Black Nylon 6.6, add suffix "0". Example: PLM1M-C0.

MARKER PLATES - Nylon 6.6 (Indoor Use)†

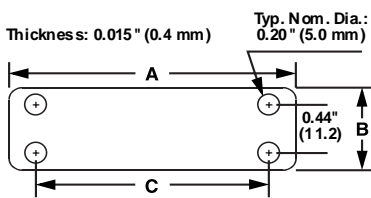

| Part Number | Use With Cable Ties | Dimensions Inches (mm) | | | Std. Pkg. Qty.* |
|-------------|------------------------|---------------------------|-------------|-------------|-----------------------|
| | | A | B | C | |
| MP150-C | M, I, S | 1.50 (38.1) | 0.75 (19.1) | 1.03 (26.2) | 100 |
| MP175-C | | 1.75 (44.5) | 0.75 (19.1) | 1.28 (32.5) | 100 |
| MP200-C | | 2.00 (50.8) | 0.75 (19.1) | 1.53 (38.4) | 100 |
| MP250-C | | 2.50 (63.5) | 0.75 (19.1) | 2.03 (51.6) | 100 |
| MP350-C | | 3.50 (88.9) | 0.75 (19.1) | 3.03 (77.0) | 100 |
| MP250W175-C | | 2.50 (63.5) | 1.75 (44.5) | 2.03 (51.6) | 100 |

*Order number of marker plates required in multiples of Standard Package Quantity.
†For Weather Resistant Black Nylon 6.6, add suffix "0". Example: MP150-C0.

For more information on the complete line of Panduit Cable Ties and Marker Plates, request the full line Cable Ties and Wiring Accessories Catalog.

Marker Ties and Marker Plates used with Computer Printable Labels (cont.)

- PDL & PLL labels are used with Marker Ties and Marker Plates
- PDL (for Dot-Matrix printers)
- PLL (For Laser Printers)
- PLL label material is good for indoor and outdoor use. Recommended if you need excellent resolution.

| TIE or PLATE Part No. | MATERIAL SELECTION ■ Label Part No. Prefix (PDL-) | | | | LASER (PLL-) | LABEL SIZE Width x Length In. (mm) | Labels Per Row | Labels Per Fanfold | Std. Pkg. Qty.* |
|--------------------------------|--|-----|-----|-----|-----------------|--|----------------------|--------------------------|-----------------------|
| | GMP1 | GMC | GMY | GMT | | | | | |
| PLM1M | 92 | 93 | 94 | 49 | | 0.90 x 0.25 (22.9 x 6.3) | 8 | 36 | 5000 |
| PLM2M | | | 285 | 284 | | 0.90 x 0.25 (22.9 x 6.3) | 8 | 32 | 5000 |
| PLF1MA | | | | | 5-Y2-10 | 0.80 x 0.25 (20.3 x 6.3) | 10 | 39 | 10,000 |
| PLF1MB | 92 | 93 | 94 | 49 | | 0.90 x 0.25 (22.9 x 6.3) | 8 | 36 | 5000 |
| SSM2S-C | | 257 | | 259 | | 0.30 x 0.94 (7.6 x 23.8) | 16 | 12 | 5000 |
| SSM4S-C | | 357 | | 259 | | 0.30 x 0.94 (7.6 x 23.8) | 16 | 12 | 5000 |
| PLF1M | 85 | 37 | 39 | 84 | | 0.75 x 0.25 (19.1 x 6.3) | 9 | 36 | 5000 |
| PLM2S | | 270 | 274 | | | 0.75 x 0.25 (19.1 x 6.3) | 9 | 32 | 5000 |
| | | | | | 4-Y2-10 | 0.65 x 0.25 (16.5 x 6.3) | 10 | 39 | 10,000 |
| PLF1MA | 122 | 119 | 121 | 120 | | 0.50 x 0.25 (12.7 x 6.3) | 12 | 12 | 5000 |
| MP150 | | 265 | | 267 | | 0.50 x 0.94 (12.7 x 23.8) | 16 | 12 | 5000 |
| MP175 | | | | | 9-Y2-10 | 1.00 x 0.50 (25.4 x 12.7) | 7 | 19 | 10,000 |
| PLM2S | | 254 | | 256 | | 0.30 x 0.75 (7.6 x 19.1) | 16 | 12 | 5000 |
| | | | | | 5-Y2-10 | 0.80 x 0.25 (20.3 x 6.3) | 8 | 39 | 10,000 |
| PLM4S | 112 | 114 | 111 | 110 | | 2.00 x 0.38 (50.8 x 9.5) | 3 | 24 | 5000 |
| | | 257 | | 259 | | 0.30 x 0.94 (7.6 x 23.8) | 16 | 12 | 5000 |
| | | | | | 16-Y2-5 | 1.88 x 0.38 (47.7 x 9.5) | 4 | 25 | 5000 |
| PL2M2S | | 19 | 20 | 99 | | 1.00 x 0.50 (25.4 x 12.7) | 7 | 18 | 5000 |
| | | 288 | | 290 | | 1.00 x 0.75 (25.4 x 19.1) | 7 | 12 | 5000 |
| | | 280 | | 282 | | 0.80 x 0.94 (20.3 x 23.8) | 10 | 12 | 5000 |
| | | | | | 9-Y2-10 | 1.00 x 0.50 (25.4 x 12.7) | 7 | 19 | 10,000 |
| PL3M2S | 73 | 72 | 27 | 231 | | 1.50 x 0.75 (38.1 x 19.1) | 4 | 12 | 5000 |
| | | 9 | | 10 | | 0.80 x 1.44 (20.3 x 36.5) | 6 | 8 | 5000 |
| | | | | | 9-Y2-10 | 1.00 x 0.50 (25.4 x 12.7) | 7 | 19 | 10,000 |
| MP150 | 174 | | 172 | | | 0.80 x 0.50 (20.3 x 12.7) | 10 | 16 | 5000 |
| MP175 | | 288 | | 290 | | 1.00 x 0.75 (25.4 x 19.1) | 7 | 12 | 5000 |
| MP200 | | | | | 9-Y2-10 | 1.00 x 0.50 (25.4 x 12.7) | 7 | 19 | 10,000 |
| MP250 | 73 | 72 | 27 | 231 | | 1.50 x 0.75 (38.1 x 19.1) | 4 | 12 | 5000 |
| MP350 | 112 | 114 | 111 | 110 | | 2.00 x 0.38 (50.8 x 9.5) | 3 | 24 | 5000 |
| | | | | | 16-Y2-5 | 1.88 x 0.38 (47.7 x 9.5) | 4 | 25 | 5000 |
| MP250W175 | 73 | 72 | 27 | 231 | | 1.50 x 0.75 (38.1 x 19.1) | 4 | 12 | 5000 |
| | | 298 | | | | 1.50 x 0.90 (38.1 x 22.9) | 4 | 12 | 5000 |
| | | | | | 17-Y2-2.5 | 1.88 x 0.83 (47.7 x 21.1) | 4 | 11 | 2500 |
| | | | | | 18-Y2-1.5 | 1.88 x 1.33 (47.7 x 33.8) | 4 | 7 | 1500 |

■ See material selection chart on page 84
 *Order number of labels required in multiples of Std. Pkg. Qty.

Wire Marking Products

Selection of Styles



Marker Books

Pages 132 to 137

Convenient, pocket sized books are an economical, handy way to use wire and identification markers. The book cover keeps the markers fresh and provides part number for re-ordering. Flexible release coated backing for easy marker removal.



Marker Cards

Pages 138 to 147

Choose from the many legends available in general purpose vinyl cloth, or from special materials available to meet a variety of application environments. All of the markers are offered in full size-1.50" (38.1 mm) long for wire outside diameter up to 0.38" (9.5 mm); half size markers for wire outside diameter up to 0.19" (4.7 mm) can be ordered.



Marker Tape

Page 148

Handy dispensers allow tape to be cut quickly and cleanly to any length for different wire or cable diameters. The tape is laminated to insure lasting legibility and resistance to abrasion, oil, water, grease and solvents. Refill rolls are available in a variety of legends.

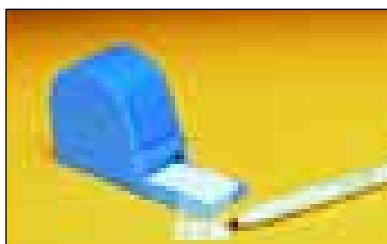

Self-Laminating Write-On Markers

Page 148

Durable dispenser filled with self-laminating write-on markers. Markers are protected inside dispenser. Markers are available in two sizes for wire outside diameter up to 0.69" (17.5 mm). Refill rolls load easily into reusable dispenser.



Slip-On Markers

Page 149

Panduit slip-on markers provide convenient, permanent identification for wire marking applications. Durable and easy to install, slip-on's expand to double their inside diameter and accommodate a wide range of wire marker diameters (5 sizes from 22AWG to 350MCM), reducing wire marker inventory.



Clip-On Markers

Page 150

Clip-on markers provide the fastest, most convenient, high visibility identification of wires, cables and tubing. All markers are supplied on a handy application wand which speeds installation. Several sizes are available for bundle diameters 0.08" (1.9 mm) through 0.62" (15.7 mm).

Wire Marker Material Selection Guide

| Material Code | Material Type | Temperature Range | Key Features | Color | Outdoor Rated | Hazardous Environment | UL Rec | CSA |
|---------------|--------------------------------|------------------------------------|---|------------------------------|---------------|-----------------------|--------|-----|
| GMA1 | Aluminum | -40°F to 300°F (-40°C to 149°C) | Dead soft aluminum foil wraps easily around wire. Resistant to solvents, oil, heat and abrasion. | Matte Silver | Yes | Yes | No | No |
| GMAC | Acetate Cloth | -30°F to 220°F (-34°C to 105°C) | Has less discoloration at high temperatures than most materials; good material for varnish dip or baking cycles | White | No | No | No | No |
| GMACT | Acetal (Non-Adhesive) | -22°F to 194°F (-30°C to 90°C) | Clip-On Wire Marker Material is very strong and has excellent resiliency; good resistance to oils and solvents | White Yellow | No | Yes | No | No |
| GMC1 | Vinyl Cloth | -50°F to 170°F (-46°C to 77°C) | General purpose wire marker material; resists oil and abrasion; can be removed and reused | White Yellow | No | No | No | No |
| GMM1 | Polyester Film | -40°F to 275°F (-40°C to 135°C) | Thin, flexible material produces low profile marker. Resistant to oil, dirt heat and abrasion | White | Yes | Yes | No | No |
| GMP1 | Destructible Paper | -65°F to 200°F (-54°C to 93°C) | Litho paper with destructible adhesive for permanent applications | White | No | No | No | No |
| GMT | TEDLAR [▲] | -40°F to 275°F (-40°C to 135°C) | Self-extinguishing film for high quality indoor/outdoor, high temperature labels | White | Yes | Yes | Yes | Yes |
| GMV1 | Vinyl Film | -40°F to 176°F (-40°C to 80°C) | General purpose vinyl film | White | Yes (2 yrs.) | No | No | No |
| GMV3 | Self-Laminating Vinyl | -40°F to 150°F (-40°C to 66°C) | Preferred material for most general wire and cable labeling; thin, conformable material | Clear w/ White Print-On Area | No | No | Yes | Yes |
| GMV11 | Vinyl Extrusion (Non-Adhesive) | -8°F to 177°F (-22°C to 80°C) | Slip-On Wire Marker Material is flexible material; good for harsh environments | White Yellow | Yes | Yes | No | No |
| GMY | Polyester | -40°F to 311°F (-40°C to 154°C) | Provides durability, high temperature resistance, and dimensional stability | White | Yes | Yes | Yes | Yes |

[▲]TEDLAR is the registered trademark of E. I. DuPont Co.

Marker Books

Pre-Assembled Books

Material: GMC1 Vinyl Cloth

- Available with white and yellow backgrounds
- Each marker is perforated to form half markers

| Marker Type | Marker Size In. (mm) | For Max. Wire O.D. |
|----------------|-----------------------------|--------------------|
| Full | 0.22 x 1.38 (5.6 x 34.9) | 0.38 (9.5) |
| Half | 0.22 x 0.69 (5.6 x 17.4) | 0.19 (4.7) |
| Terminal Block | 0.22 x 0.25 (5.6 x 6.3) | — |

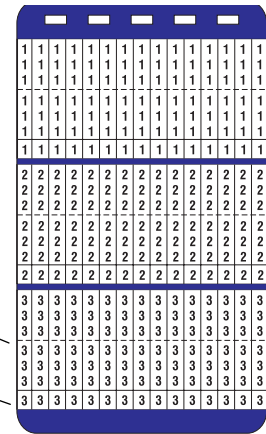

Perforation for half marker
Terminal Block Marker

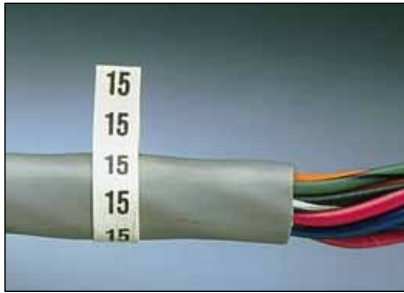

Markers can be used as temporary flag markers



Markers can be torn in half at perforation to mark both ends of conductor

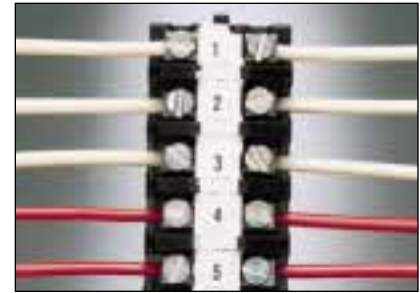

Terminal Block Marker is provided to permanently identify terminal connections

| Black Legend on White Part Number | Black Legend on Yellow Part Number | Legend | Number of Markers Each Legend | Pages Per Book | Std. Pkg. Qty.* | Std. Ctn. Qty. |
|-----------------------------------|------------------------------------|--|-------------------------------|----------------|-----------------|----------------|
| PCMB-1 | PCYMB-1 | 0 thru 9 | 45 | 10 Pgs. | 1 Book | 10 Books |
| PCMB-2 | PCYMB-2 | A thru Z, 0 thru 15, +, -, / | 10 | | | |
| PCMB-3 | PCYMB-3 | 1 thru 45 | 10 | | | |
| PCMB-4 | PCYMB-4 | 1, 2, 3 | 150 | | | |
| PCMB-5 | PCYMB-5 | A, B, C | 150 | | | |
| PCMB-6 | PCYMB-6 | T1, T2, T3 | 150 | | | |
| PCMB-7 | PCYMB-7 | L1, L2, L3 | 150 | | | |
| PCMB-8 | PCYMB-8 | 1 thru 15 | 6 | | | |
| | | 16 thru 90 | 4 | | | |
| | | A thru Z, +, -, /, 0 | 2 | | | |
| PCMB-9 | PCYMB-9 | 1, 2, 3, A, B, C | 45 | | | |
| | | L1, L2, L3, T1, T2, T3 | 30 | | | |
| PCMB-10 | — | Solid NEMA colors: red, yellow, white, light blue, light green, black, brown, orange, gray, dark green | 45 each color | | | |
| PCMB-11 | — | 1 thru 30 | 15 | | | |
| PCMB-12 | — | A thru Z | 15 | | | |
| | | + | 8 | | | |
| | | - | 7 | | | |
| | | Blank (write on) | 21 | | | |
| PCMB-13 | — | +, -, AC, DC | 45 | | | |
| | | POS, NEG, GND | 33 | | | |
| | | NEUT | 27 | | | |
| | | SPARE, Blank (write-on) | 21 | | | |
| PCMB-14 | — | 46 thru 90 | 10 | | | |
| PCMB-15 | — | 0 thru 45, +, - | 10 | | | |
| PCMB-16 | — | 0 thru 33, A, B, C, +, - | 10 | | | |
| | | L1, L2, L3, T1, T2, T3 | 10 | | | |
| PCMB-25 | — | 0 thru 9 | 45 | | | |
| | | L1, L2, L3, T1, T2, T3 | 15 | | | |

*Order number of books required in multiples of Std. Pkg. Qty.; Std. Ctn. is for order convenience.

Marker Books (cont.)

Replacement Pages
(for marker books or index files)
Material: GMC1 Vinyl Cloth

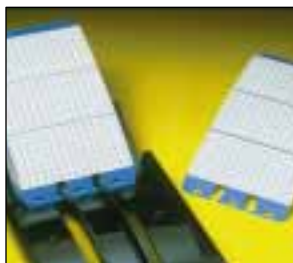

Replacement pages can be used in OEM applications and held in typical "roll-over" index card holders



Convenient replacement pages offer versatility for applications that require a variety of different identification requirements

| Marker Type | Marker Size In. (mm) | For Max. Wire O.D. |
|----------------|-----------------------------|--------------------|
| Full | 0.22 x 1.38 (5.6 x 34.9) | 0.38 (9.5) |
| Half | 0.22 x 0.69 (5.6 x 17.4) | 0.19 (4.7) |
| Terminal Block | 0.22 x 0.25 (5.6 x 6.3) | — |

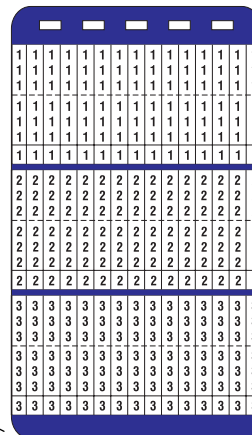

Perforation to form half markers

Terminal Block Marker

Sturdy rigid liner stands up firmly index card holder

| Part Number | Legend | Number of Markers Each Legend | Pages Per Book | Std. Pkg. Qty.* | Std. Ctn. Qty. |
|---|---|-------------------------------|----------------|-----------------|----------------|
| Numbers | | | | | |
| PCMBR-0 PCMBR-1 thru PCMBR-99 | 0 1 thru 99 | 450 | 10 Pgs. | 1 Book | 10 Books |
| PCMBR-100 | 100 | 330 | | | |
| PCMBR-0-9 PCMBR-10-19 thru PCMBR-90-99 | 0 thru 9 10 thru 19 (one full page of each legend) thru 90 thru 99 | 45 | | | |
| PCMBR-100-109 thru PCMBR-190-199 | 100 thru 109 thru (one full page of each legend) 190 thru 199 | 33 | | | |
| Letters | | | | | |
| PCMBR-A thru PCMBR-Z | A thru Z | 450 | 10 Pgs. | 1 Book | 10 Books |
| PCMBR-A-Z | A thru Z, /, +, -, 0 thru 15 | 10 | | | |
| Symbols | | | | | |
| PCMBR-T1-T3 | T1, T2, T3 | 150 | 10 Pgs. | 1 Book | 10 Books |
| PCMBR-L1-L3 | L1, L2, L3 | 150 | | | |
| PCMBR-PLS | + | 450 | | | |
| PCMBR-MIN | - | 450 | | | |

Legend: Black Background: White
*Order number of books required in multiples of Std. Pkg. Qty.; Std. Ctn. is for order convenience.

Marker Books (cont.)

Pre-Assembled Self-Laminating Books Material: GMV3 Self-Laminating Vinyl



- Self-laminate protects the legend against water, grease or solvents
- Provides quick, clear identification of wires or cables
- Marker Size: 0.22" x 1.38" (5.6 mm x 34.9 mm)

| | | | | | | | | | | | | | | | | | | | |
|----|----|----|----|----|----|---|---|---|---|---|---|---|---|---|---|---|---|---|---|
| / | / | / | / | / | / | / | / | / | / | / | / | / | / | / | / | / | / | / | / |
| 0 | N | M | L | K | J | I | H | G | F | E | D | C | B | A | / | / | / | / | / |
| 0 | N | M | L | K | J | I | H | G | F | E | D | C | B | A | / | / | / | / | / |
| 0 | N | M | L | K | J | I | H | G | F | E | D | C | B | A | / | / | / | / | / |
| 0 | - | + | / | Z | Y | X | W | V | U | T | S | R | Q | P | / | / | / | / | / |
| 0 | - | + | / | Z | Y | X | W | V | U | T | S | R | Q | P | / | / | / | / | / |
| 0 | - | + | / | Z | Y | X | W | V | U | T | S | R | Q | P | / | / | / | / | / |
| 15 | 14 | 13 | 12 | 11 | 10 | 9 | 8 | 7 | 6 | 5 | 4 | 3 | 2 | 1 | / | / | / | / | / |
| 15 | 14 | 13 | 12 | 11 | 10 | 9 | 8 | 7 | 6 | 5 | 4 | 3 | 2 | 1 | / | / | / | / | / |
| 15 | 14 | 13 | 12 | 11 | 10 | 9 | 8 | 7 | 6 | 5 | 4 | 3 | 2 | 1 | / | / | / | / | / |

| Part Number | Legend | Number of Markers Each Legend | Marker Size Width x Length In. (mm) | For Max. Wire O.D. In. (mm) | Pages Per Book | Std. Pkg. Qty.* | Std. Ctn. Qty. |
|-------------|------------------------------|-------------------------------|-------------------------------------|-----------------------------|----------------|-----------------|----------------|
| PLMA1 | 0 thru 9 | 45 | 0.22 x 1.56 (5.6 x 39.7) | 0.19 (4.7) | 10 Pgs. | 1 Book | 10 Books |
| PLMA2 | A thru Z, 0 thru 15, +, -, / | 10 | | | | | |
| PLMA3 | 1 thru 45 | 10 | | | | | |
| PLMA4 | 1, 2, 3 | 150 | | | | | |
| PLMA5 | A, B, C | 150 | | | | | |
| PLMA6 | T1, T2, T3 | 150 | | | | | |
| PLMA8 | 1 thru 15 | 6 | | | | | |
| | 16 thru 90 | 4 | | | | | |
| | A thru Z, +, -, /, 0 | 2 | | | | | |
| PLMA9 | 1, 2, 3, A, B, C | 45 | | | | | |
| | L1, L2, L3, T1, T2, T3 | 30 | | | | | |
| PLMA11 | 1 thru 30 | 15 | | | | | |
| PLMA12 | A thru Z | 15 | | | | | |
| | + | 8 | | | | | |
| | - | 7 | | | | | |
| | Blank (write on) | 21 | | | | | |
| PLMA13 | +, -, AC, DC | 45 | | | | | |
| | POS, NEG, GND | 33 | | | | | |
| | NEUT | 27 | | | | | |
| | SPARE, Blank (write-on) | 21 | | | | | |
| PLMA14 | 46 thru 90 | 10 | | | | | |
| PLMA15 | 0 thru 45, +, - | 10 | | | | | |
| PLMA16 | 0 thru 33, A, B, C, +, - | 10 | | | | | |
| | L1, L2, L3, T1, T2, T3 | 10 | | | | | |

*Order number of books required in multiples of Std. Pkg. Qty.; Std. Ctn. is for order convenience.

Load Center Markers

Used to Identify Circuits on Residential Breaker Panels

Material: GMC1 Vinyl Cloth



Marker Size: 1.41" x 0.75"
(35.8 mm x 19.0 mm)

| Part Number | Legend | Total Markers Each Legend | Pages Per Book | Std. Pkg. Qty.* | Std. Ctn. Qty. |
|-------------|--|---------------------------|----------------|-----------------|----------------|
| PCMB-LC | (2) each/page: Main, Oven, D. Washer, S. Pump, W. Pump, Kitchen, Fam. Rm., Mn. Bath, Mr. Bath, Pwd. Rm., Mr. B'rm., B'rm. 2, B'rm. 3, B'rm. 4, Utl. Rm., Range, Dryer, Disposal, Heating, Air. Cond., Garage, Din. Rm., Liv. Rm. | 20 | 5 pgs. | 1 Book | 10 Books |

Black legend on white background

*Order number of books required in multiples of Std. Pkg. Qty.; Std. Ctn. Qty. is for order convenience

Marker Books (cont.)

Blank Self-Laminating Write-On Cable Marker Books

Material: GMV3 Self-Laminating Vinyl



Blank write-on area available in a variety of sizes and colors



Quick, clear identification of wires or cable

Mark write-on area using Panduit fast-drying, non-smear, marking pens found on [page 137](#)

Self laminate protects the legend against water, grease, oil or solvents



| Part Number | Write-On Area Color | Write-On Area Size Width x Length In. (mm) | Total Marker Size Width x Length In. (mm) | For Maximum Wire O.D. In. (mm) | Total Markers per Page | Pages Per Book | Std. Pkg. Qty.* | Std. Ctn. Qty. |
|-------------|---|--|---|--------------------------------|------------------------|----------------|-----------------|----------------|
| PSCB-12 | White | 1.00 x 0.75 (25.4 x 19.1) | 1.00 x 3.00 (25.4 x 76.2) | 0.69 (17.5) | 6 | 10 pgs. | 1 Book | 10 Books |
| PSCB-3 | White | | | | | | | |
| PSCB-3BLK | Black | | | | | | | |
| PSCB-3BLU | Blue | | | | | | | |
| PSCB-3GRN | Green | | | | | | | |
| PSCB-3RED | Red | | | | | | | |
| PSCB-3YEL | Yellow | | | | | | | |
| PSCB-3C | 2 Pages Each: Black, Blue, Green, Red, Yellow | | | | | | | |
| PSCB-13 | White | 1.50 x 0.75 (38.1 x 19.1) | 1.50 x 3.00 (38.1 x 76.2) | 0.69 (17.5) | 4 | | | |
| PSCB-5 | White | 1.00 x 1.00 (25.4 x 25.4) | 1.00 x 5.00 (25.4 x 127.0) | 1.25 (31.7) | 3 | | | |
| PSCB-6 | White | 1.00 x 1.00 (25.4 x 25.4) | 1.00 x 6.00 (25.4 x 152.4) | 1.56 (39.7) | 3 | | | |
| PSCB-6BLU | Blue | | | | | | | |
| PSCB-6GRN | Green | | | | | | | |
| PSCB-6RED | Red | | | | | | | |
| PSCB-6YEL | Yellow | | | | | | | |
| PSCB-6C | 2 Pages Each: Black, Blue, Green, Red, Yellow | | | | | | | |
| PSCB-16 | White | 1.50 x 1.00 (38.1 x 25.4) | 1.50 x 6.00 (38.1 x 152.4) | 1.56 (39.7) | 2 | | | |

*Order number of books required in multiples of Std. Pkg. Qty.; Std. Ctn. Qty. is for order convenience

Other Self-Laminating Wire Markers available: Thermal Transfer ([pg. 36](#)), Laser ([pgs. 60-61](#)), Dot-Matrix ([pgs. 85-87](#)), Card ([pg. 146](#)), Dispenser ([pg. 148](#))

Network Systems Marker Books

Identify wires, cables and outlets for telephone, computer or peripheral connections

Material: GMY Polyester



MINI-JACK™ Labels



Available in 2 styles:

- Wrap-Around



- Standard



Wrap-Around Label Marker Books

| Black on Clear Part Numbers | Legend | Total Markers Each Legend (Book) | Size Width x Length In. (mm) | Std. Pkg. Qty.* |
|-----------------------------|------------------|----------------------------------|------------------------------|----------------------|
| PJIBM-COM | VOICE, DATA, FAX | 248/248/124 | 1.38 x 0.19 (34.9 x 4.8) | 1 Book (10 pages) |
| PJIBM-V | VOICE | 620 | | |
| PJIBM-D | DATA | 620 | | |
| PJIBM-DEC | DEC | 620 | | |
| PJIBM-LAN | LAN | 620 | | |
| PJIBM-BLNK | (blank) | 620 | | |
| PJIBM-COMS | | 248/248/124 | | |
| PJIBM-VS | | 620 | | |
| PJIBM-DS | | 620 | | |

*Order number of books required in multiples of Std. Pkg. Qty.

Standard Label Marker Books

| Black on Clear Part Numbers | White on Clear Part Numbers | Legend | Total Markers Each Legend (Book) | Size Width x Length In. (mm) | Std. Pkg. Qty.* |
|-----------------------------|-----------------------------|------------------|----------------------------------|------------------------------|---------------------|
| PSCBF-COM | PSWBF-COM | VOICE, DATA, FAX | 300/300/150 | 0.56 x 0.19 (14.3 x 4.8) | 1 Book (5 pages) |
| PSCBF-V | PSWBF-V | VOICE | 750 | | |
| PSCBF-D | PSWBF-D | DATA | 750 | | |
| PSCBF-BLNK | — | (blank) | 750 | | |
| PSCBF-COMS | PSWBF-COMS | | 300/300/150 | | |
| PSCBF-VS | PSWBF-VS | | 750 | | |
| PSCBF-DS | PSWBF-DS | | 750 | | |
| PSCBF-FO | PSWBF-FO | FIBER OPTIC, | 375/375 | | |
| PSCBF-M | — | †See Note | 750 | | |

*Order number of books required in multiples of Std. Pkg. Qty.

†Note: PSCBF-M is a "Universal Network Labeling Book" designed to meet most network labeling requirements. Legends include: DATA 1 thru 8, COM 1 thru 8, VOICE 1 thru 8, DATA A thru H, COM A thru H, CAT 5, CAT V, FAX, PHONE, E-NET, LAN, MODEM, PRINTER, 1 thru 8, A thru H and the Data, Voice and Fax symbols shown above.

Surface Mount Box Labels



- Write-on area for marking of extension number, etc. Use Panduit Marking Pen (PFX-0) shown below.

Surface Mount Box Marker Books

| Black on Clear Part Number | Legend | Total Markers Each Legend (Book) | Size Width x Length In. (mm) | Std. Pkg. Qty.* |
|----------------------------|------------------|----------------------------------|------------------------------|----------------------|
| PSCB-COM | VOICE, DATA, FAX | 200/200/100 | 0.56 x 0.56 (14.3 x 14.3) | 1 Book (10 pages) |
| PSCB-V | VOICE | 500 | | |
| PSCB-D | DATA | 500 | | |
| PSCB-LAN | LAN | 500 | | |
| PSCB-BLNK | (blank) | 500 | | |
| PSCB-COMS | | 200/200/100 | | |
| PSCB-VS | | 500 | | |
| PSCB-DS | | 500 | | |

*Order number of books required in multiples of Std. Pkg. Qty.

Marking Pens



- Fast drying permanent ink

| Part Number | Color | Description | Std. Pkg.* | Std. Ctn. |
|-------------|-------|--|------------|-----------|
| PX-0 | Black | Color of pen is color of ink. Reversible tip to extend life of pen. | 12 | 48 |
| PX-2 | Red | | 12 | 48 |
| PFX-0 | Black | For detailed marking on nylon surfaces. Color cap and end is color of ink. | 12 | 48 |
| PFX-2 | Red | | 12 | 48 |

*Order number of pens required in multiple of Std. Pkg. Qty.; Std. Ctn. is for order convenience.

Marker Cards

Solid Numbers

| Marker Type | Marker Length In. (mm) | For Max. Wire O.D. |
|-------------|------------------------|--------------------|
| Full | 1.50 (38.1) | 0.38 (9.5) |
| Half | 0.75 (19.1) | 0.19 (4.7) |

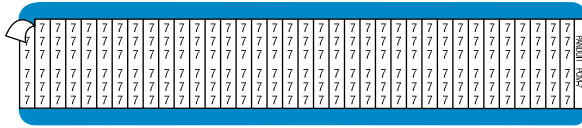

Type PCM, PACM, PALM and PPM

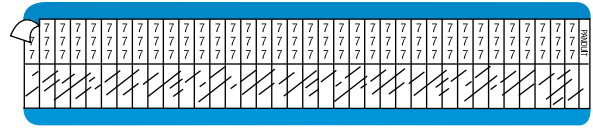

Type PSM

| Legend | Part Number | | | | | Mkrs Per Card Full/Half † | Std. Pkg. Qty.* |
|-----------|-------------------|---------------------|---------------------|-------------------|---------------------|---------------------------|-----------------|
| | GMC1 Vinyl Cloth | GMAC Acetate Cloth | GMA1 Aluminum | GMM1 Polyester | GMV3 Self-Lam Vinyl | | |
| 0 Thru 25 | PCM-0 Thru PCM-25 | PACM-0 Thru PACM-25 | PALM-0 Thru PALM-25 | PPM-0 Thru PPM-25 | PSM-0 Thru PSM-25 | 36/72 | 25 Cards |
| Thru 49 | Thru PCM-49 | — | — | Thru PPM-49 | Thru PSM-49 | 36/72 | |
| Thru 99 | Thru PCM-99 | — | — | — | Thru PSM-99 | 36/72 | |
| Thru 200 | Thru PCM-200 | — | — | — | Thru PSM-200 | 25/50 | |
| Thru 600 | Thru PCM-600 | — | — | — | — | 25/50 | |
| | | | | | | | |

†Half length markers available for PCM parts above. To order, substitute PCMH for PCM.

Consecutive Numbers

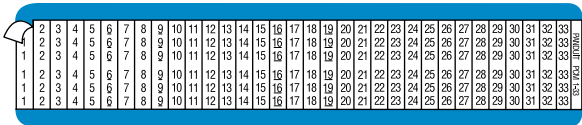

Type PCM, PACM, PALM and PPM

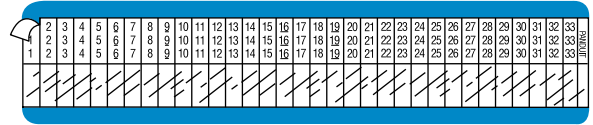

Type PSM

| Legend | Part Number | | | | | Mkrs Per Card Full/Half † | Std. Pkg. Qty.* |
|--|--|---------------------------------------|---------------------------------------|--|------------------------------------|----------------------------------|-----------------|
| | GMC1 Vinyl Cloth | GMAC Acetate Cloth | GMA1 Aluminum | GMM1 Polyester | GMV3 Self-Lam Vinyl | | |
| 1-33 34-66 67-99 | PCM-1-33 PCM-34-66 PCM-67-99 | PACM-1-33 PACM-34-66 PACM-67-99 | PALM-1-33 PALM-34-66 PALM-67-99 | PPM-1-33 PPM-34-66 PPM-67-99 | PSM-1-33 PSM-34-66 PSM-67-99 | 33/66 33/66 33/66 | 25 Cards |
| 100-124 125-149 150-174 Thru 675-699 | PCM-100-124 PCM-125-149 PCM-150-174 Thru PCM-675-699 | — | — | PPM-100-124 PPM-125-149 PPM-150-174 Thru PPM-675-699 | — | 25/50 25/50 25/50 25/50 | |
| Thru 1975-1999 | Thru PCM-1975-1999 | — | — | — | — | 25/50 | |
| | | | | | | | |

†Half length markers available for PCM parts above. To order, substitute PCMH for PCM.

Marker Cards (cont.)

Consecutive Numbers Repeated

| Marker Type | Marker Length In. (mm) | For Max. Wire O.D. |
|-------------|------------------------|--------------------|
| Full | 1.50 (38.1) | 0.38 (9.5) |
| Half | 0.75 (19.1) | 0.19 (4.7) |

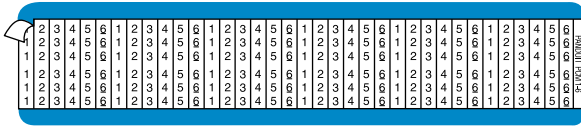

Type PCM, PALM and PPM

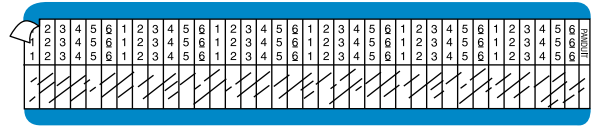

Type PSM

| Legend | Part Number | | | | Mkrs Per Card Full/Half † | Std. Pkg. Qty.* |
|-----------------------------|------------------|---------------|----------------|---------------------|---------------------------|-----------------|
| | GMC1 Vinyl Cloth | GMA1 Aluminum | GMM1 Polyester | GMV3 Self-Lam Vinyl | | |
| (12) ea. 1-3 | PCM-1-3 | — | — | — | 36/72 | 25 Cards |
| (9) ea. 1-4 | PCM-1-4 | — | — | — | 36/72 | |
| (8) ea. 1 (7) ea. 2-5 | PCM-1-5 | — | — | — | 36/72 | |
| (6) ea. 1-6 | PCM-1-6 | — | PPM-1-6 | — | 36/72 | |
| (5) ea. 1-4 (4) ea. 5-8 | PCM-1-8 | — | — | — | 36/72 | |
| (4) ea. 1-9 | PCM-1-9 | — | — | — | 36/72 | |
| (4) ea. 0-5 (3) ea. 6-9 | PCM-0-9 | — | PPM-0-9 | PSM-0-9 | 36/72 | |
| (4) ea. 1-3 (3) ea. 4-10 | PCM-1-10 | PALM-1-10 | — | — | 36/72 | |
| (3) ea. 1-12 | PCM-1-12 | — | PPM-1-12 | — | 36/72 | |
| (4) ea. 1-4 (3) ea. 5-16 | PCM-1-16 | — | — | — | 36/72 | |
| (2) ea. 1-18 | PCM-1-18 | — | PPM-1-18 | — | 36/72 | |
| (2) ea. 19-36 | PCM-19-36 | — | — | — | 36/72 | |

†Half length markers available for PCM parts above. To order, substitute PCMH for PCM.

Suffix Numbers

Suffix numbers are used to extend numbers or to create alpha-numeric codes. For example, adding suffix number 10 to number 700 creates 70010.

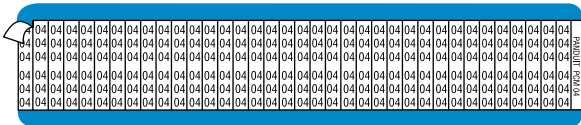

Type PCM

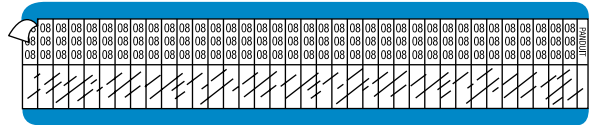

Type PSM

| Legend | Part Number | | Mkrs Per Card | Std. Pkg. Qty.* |
|---------|------------------|---------------------|---------------|-----------------|
| | GMC1 Vinyl Cloth | GMV3 Self-Lam Vinyl | | |
| 00 | PCM-00 | PSM-00 | 36 | 25 Cards |
| 01 | PCM-01 | PSM-01 | 36 | |
| Thru 09 | PCM-09 | Thru PSM-09 | 36 | |
| 00-09 | PCM-00-09 | — | 36 | |

NOTE: Part PCM-00-09 is a card of markers in 00 to 09 sequence with three sequences on a card.

Marker Cards (cont.)

Solid Letters

| Marker Type | Marker Length In. (mm) | For Max. Wire O.D. |
|-------------|------------------------|--------------------|
| Full | 1.50 (38.1) | 0.38 (9.5) |
| Half | 0.75 (19.1) | 0.19 (4.7) |



Type PCM, PACM, PALM and PPM

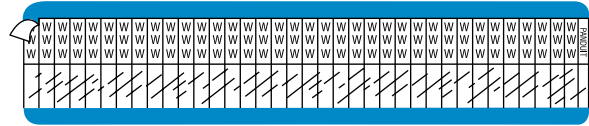

Type PSM

| Legend | Part Number | | | | | Mkrs Per Card Full/Half † | Std. Pkg. Qty.* |
|---------------------|---------------------------------|------------------------------------|------------------------------------|---------------------------------|---------------------------------|---------------------------|-----------------|
| | GMC1 Vinyl Cloth | GMAC Acetate Cloth | GMA1 Aluminum | GMM1 Polyester | GMV3 Self-Lam Vinyl | | |
| A B Thru Z | PCM-A PCM-B Thru PCM-Z | PACM-A PACM-B Thru PACM-Z | PALM-A PALM-B Thru PALM-Z | PPM-A PPM-B Thru PPM-Z | PSM-A PSM-B Thru PSM-Z | 36/72 36/72 36/72 | 25 Cards |

†Half length markers available for PCM parts above. To order, substitute PCMH for PCM.

Consecutive Letters

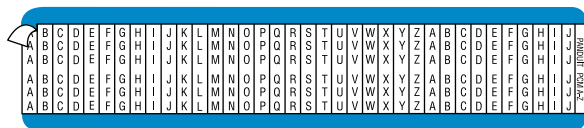

PCM-A-Z, PALM-A-Z, PPM-A-Z

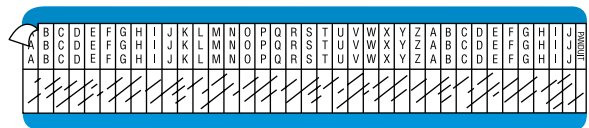

PSM-A-Z

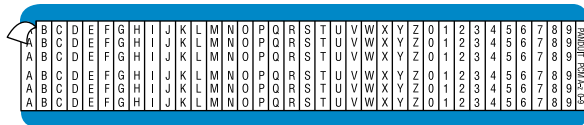

PCM-A-Z-0-9

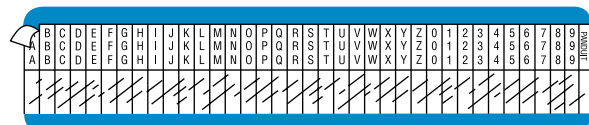

PSM-A-Z-0-9

| Legend | Part Number | | | | Mkrs Per Card Full/Half † | Std. Pkg. Qty.* |
|--------------------------------------|------------------|---------------|----------------|---------------------|---------------------------|-----------------|
| | GMC1 Vinyl Cloth | GMA1 Aluminum | GMM1 Polyester | GMV3 Self-Lam Vinyl | | |
| (2) ea. A thru J (1) ea. K thru Z | PCM-A-Z | PALM-A-Z | PPM-A-Z | PSM-A-Z | 36/72 | 25 Cards |
| (1) ea. A thru Z (1) ea. 0 thru 9 | PCM-A-Z-0-9 | — | — | PSM-A-Z-0-9 | 36/72 | |

†Half length markers available for PCM parts above. To order, substitute PCMH for PCM.

Marker Cards (cont.)

| Marker Type | Marker Length In. (mm) | For Max. Wire O.D. |
|-------------|------------------------|--------------------|
| Full | 1.50 (38.1) | 0.38 (9.5) |
| Half | 0.75 (19.1) | 0.19 (4.7) |

Solid Letters and Numbers (Used in combination with each other)

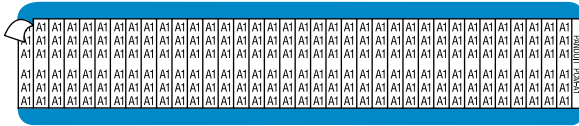

Type PCM, PALM and PPM

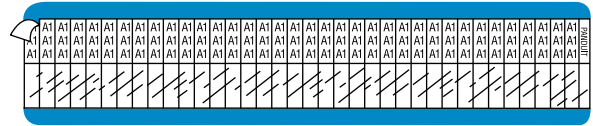

Type PSM

| Legend | Part Number | | | | Mkrs Per Card Full/Half † | Std. Pkg. Qty.* |
|---|---|--|--|--|---|-----------------|
| | GMC1 Vinyl Cloth | GMA1 Aluminum | GMM1 Polyester | GMV3 Self-Lam Vinyl | | |
| A1 A2 A3 A4 A5 | PCM-A1 PCM-A2 PCM-A3 PCM-A4 PCM-A5 | PALM-A1 PALM-A2 — — — | PPM-A1 PPM-A2 — — — | PSM-A1 PSM-A2 PSM-A3 — — | 36/72 36/72 36/72 36/72 36/72 | 25 Cards |
| B1 Thru B5 | PCM-B1 Thru PCM-B5 | — — — — — | — — — — — | — — — — — | 36/72 36/72 | |
| C1 C2 Thru C5 | PCM-C1 PCM-C2 Thru PCM-C5 | — — — — — | PPM-C1 PPM-C2 — — — | — — — — — | 36/72 36/72 36/72 | |
| D1 Thru D5 | — — — — — | — — — — — | — — — — — | PSM-D1 Thru PSM-D5 | 36/72 36/72 | |
| E1 Thru E5 | PCM-E1 Thru PCM-E5 | — — — — — | — — — — — | — — — — — | 36/72 36/72 | |
| F1 F2 F3 F4 F5 | PCM-F1 PCM-F2 PCM-F3 PCM-F4 PCM-F5 | PALM-F1 PALM-F2 — — — | PPM-F1 PPM-F2 PPM-F3 — — | — — — — — | 36/72 36/72 36/72 36/72 36/72 | |
| H1 Thru H4 H5 | PCM-H1 Thru PCM-H4 PCM-H5 | — — — — — | PPM-H1 Thru PPM-H4 — | — — — — — | 36/72 36/72 36/72 | |
| J1 Thru J4 | PCM-J1 Thru PCM-J4 | — — — — — | — — — — — | — — — — — | 36/72 36/72 | |
| L1 L2 L3 L4 L5 | PCM-L1 PCM-L2 PCM-L3 PCM-L4 PCM-L5 | PALM-L1 PALM-L2 PALM-L3 — — | PPM-L1 PPM-L2 PPM-L3 — — | PSM-L1 PSM-L2 PSM-L3 — — | 36/72 36/72 36/72 36/72 36/72 | |
| M1 Thru M5 | PCM-M1 Thru PCM-M5 | — — — — — | — — — — — | — — — — — | 36/72 36/72 | |
| P1 P2 P3 P4 | PCM-P1 PCM-P2 PCM-P3 PCM-P4 | PALM-P1 PALM-P2 — — — | PPM-P1 PPM-P2 — — — | — — — — — | 36/72 36/72 36/72 36/72 | |
| R1 Thru R5 | PCM-R1 Thru PCM-R5 | — — — — — | — — — — — | — — — — — | 36/72 36/72 | |
| S1 S2 S3 S4 S5 | PCM-S1 PCM-S2 PCM-S3 PCM-S4 PCM-S5 | PALM-S1 PALM-S2 — — — | PPM-S1 PPM-S2 PPM-S3 PPM-S4 — | — — — — — | 36/72 36/72 36/72 36/72 36/72 | |
| T1 T2 T3 T4 T5 T6 Thru T10 | PCM-T1 PCM-T2 PCM-T3 PCM-T4 PCM-T5 PCM-T6 Thru PCM-T10 | PALM-T1 PALM-T2 PALM-T3 PALM-T4 PALM-T5 PALM-T6 — — | PPM-T1 PPM-T2 PPM-T3 PPM-T4 — — — — | PSM-T1 PSM-T2 PSM-T3 — — — — | 36/72 36/72 36/72 36/72 36/72 36/72 36/72 | |

†Half length markers available for PCM parts above. To order, substitute PCMH for PCM.

More legends shown on next page.

Marker Cards (cont.)

Solid Letters and Numbers (cont.)

| Marker Type | Marker Length In. (mm) | For Max. Wire O.D. |
|-------------|------------------------|--------------------|
| Full | 1.50 (38.1) | 0.38 (9.5) |
| Half | 0.75 (19.1) | 0.19 (4.7) |

| Legend | Part Number | | | | Mkrs Per Card Full/Half † | Std. Pkg. Qty.* |
|--------|------------------|---------------|----------------|---------------------|---------------------------|-----------------|
| | GMC1 Vinyl Cloth | GMA1 Aluminum | GMM1 Polyester | GMV3 Self-Lam Vinyl | | |
| X1 | PCM-X1 | PALM-X1 | PPM-X1 | PSM-X1 | 36/72 | 25 Cards |
| X2 | PCM-X2 | PALM-X2 | PPM-X2 | PSM-X2 | 36/72 | |
| X3 | PCM-X3 | — | PPM-X3 | — | 36/72 | |
| X4 | PCM-X4 | — | PPM-X4 | — | 36/72 | |
| Y1 | PCM-Y1 | — | — | — | 36/72 | |
| Y2 | PCM-Y2 | — | — | — | 36/72 | |
| Z1 | PCM-Z1 | — | — | — | 36/72 | |
| Z2 | PCM-Z2 | — | — | — | 36/72 | |
| Z3 | PCM-Z3 | — | — | — | 36/72 | |

†Half length markers available for PCM parts above. To order, substitute PCMH for PCM.

Consecutive Letters and Numbers Repeated

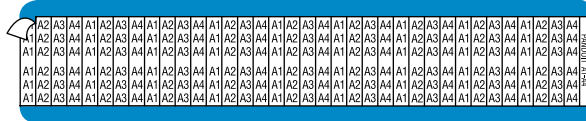

Type PCM

| Legend | Part Number | Mkrs Per Card Full/Half † | Std. Pkg. Qty.* |
|---------------|------------------|---------------------------|-----------------|
| | GMC1 Vinyl Cloth | | |
| (9) ea. A1-A4 | PCM-A1-A4 | 36/72 | 25 Cards |
| (9) ea. F1-F4 | PCM-F1-F4 | 36/72 | |
| (9) ea. H1-H4 | PCM-H1-H4 | 36/72 | |
| (9) ea. L1-L4 | PCM-L1-L4 | 36/72 | |
| (9) ea. T1-T4 | PCM-T1-T4 | 36/72 | |
| (9) ea. W1-W4 | PCM-W1-W4 | 36/72 | |
| (9) ea. X1-X4 | PCM-X1-X4 | 36/72 | |

†Half length markers available for PCM parts above. To order, substitute PCMH for PCM.

Solid NEMA Colors (Blank)

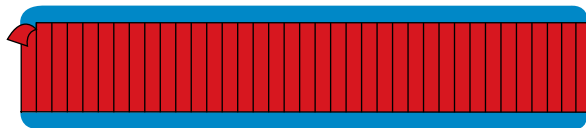

Type PCM and PPM

| Color | Part Number | | Mkrs Per Card Full/Half † | Std. Pkg. Qty.* |
|-------------|------------------|----------------|---------------------------|-----------------|
| | GMC1 Vinyl Cloth | GMM1 Polyester | | |
| Black | PCM-BLK | PPM-BLK | 36/72 | 25 Cards |
| Brown | PCM-BRN | PPM-BRN | 36/72 | |
| Dark Blue | PCM-DBL | PPM-DBL | 36/72 | |
| Dark Green | PCM-DGN | PPM-DGN | 36/72 | |
| Gray | PCM-GRY | PPM-GRY | 63/72 | |
| Light Blue | PCM-LBL | PPM-LBL | 36/72 | |
| Light Green | PCM-LGN | PPM-LGN | 36/72 | |
| Orange | PCM-ORN | PPM-ORN | 36/72 | |
| Pink | PCM-PNK | PPM-PNK | 36/72 | |
| Purple | PCM-PUR | PPM-PUR | 36/72 | |
| Red | PCM-RED | PPM-RED | 36/72 | |
| Tan | PCM-TAN | PPM-TAN | 36/72 | |
| White | PCM-WHT | PPM-WHT | 36/72 | |
| Yellow | PCM-YEL | PPM-YEL | 36/72 | |

†Half length markers available for PCM parts above. To order, substitute PCMH for PCM.

Marker Cards (cont.)

Solid Machine Tool Symbols

| Marker Type | Marker Length In. (mm) | For Max. Wire O.D. |
|-------------|------------------------|--------------------|
| Full | 1.50 (38.1) | 0.38 (9.5) |
| Half | 0.75 (19.1) | 0.19 (4.7) |



Type PCM

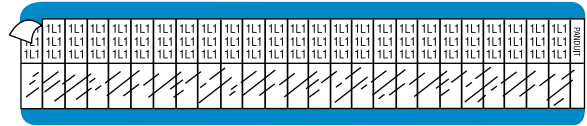

Type PSM

| Legend | Part Number | | Mkrs Per Card Full/Half† | Std. Pkg. Qty.* |
|--------|------------------|---------------------|--------------------------|-----------------|
| | GMC1 Vinyl Cloth | GMV3 Self-Lam Vinyl | | |
| 1L1 | PCM-1L1 | PSM-1L1 | 25/50 | 25 Cards |
| 1L2 | PCM-1L2 | PSM-1L2 | 25/50 | |
| 1L3 | PCM-1L3 | PSM-1L3 | 25/50 | |
| 2L1 | PCM-2L1 | PSM-2L1 | 25/50 | |
| 2L2 | PCM-2L2 | PSM-2L2 | 25/50 | |
| 2L3 | PCM-2L3 | PSM-2L3 | 25/50 | |
| 3L1 | PCM-3L1 | PSM-3L1 | 25/50 | |
| 3L2 | PCM-3L2 | PSM-3L2 | 25/50 | |
| 3L3 | PCM-3L3 | PSM-3L3 | 25/50 | |
| 4L1 | PCM-4L1 | PSM-4L1 | 25/50 | |
| 4L2 | PCM-4L2 | PSM-4L2 | 25/50 | |
| 4L3 | PCM-4L3 | PSM-4L3 | 25/50 | |
| 4L4 | — | PSM-4L4 | 25/50 | |
| 5L1 | PCM-5L1 | — | 25/50 | |
| 5L2 | PCM-5L2 | — | 25/50 | |
| 5L3 | PCM-5L3 | — | 25/50 | |
| 6L1 | PCM-6L1 | — | 25/50 | |
| 6L2 | PCM-6L2 | — | 25/50 | |
| 6L3 | PCM-6L3 | — | 25/50 | |
| 7L1 | PCM-7L1 | — | 25/50 | |
| 7L2 | PCM-7L2 | — | 25/50 | |
| 7L3 | PCM-7L3 | — | 25/50 | |
| 8L1 | PCM-8L1 | — | 25/50 | |
| 8L2 | PCM-8L2 | — | 25/50 | |
| 8L3 | PCM-8L3 | — | 25/50 | |
| 9L1 | PCM-9L1 | — | 25/50 | |
| 9L2 | PCM-9L2 | — | 25/50 | |
| 9L3 | PCM-9L3 | — | 25/50 | |
| 10L1 | PCM-10L1 | — | 25/50 | |
| 10L2 | PCM-10L2 | — | 25/50 | |
| 10L3 | PCM-10L3 | — | 25/50 | |
| 1T1 | PCM-1T1 | PSM-1T1 | 25/50 | |
| 1T2 | PCM-1T2 | PSM-1T2 | 25/50 | |
| 1T3 | PCM-1T3 | PSM-1T3 | 25/50 | |
| 2T1 | PCM-2T1 | PSM-2T1 | 25/50 | |
| 2T2 | PCM-2T2 | PSM-2T2 | 25/50 | |
| 2T3 | PCM-2T3 | PSM-2T3 | 25/50 | |
| 3T1 | PCM-3T1 | PSM-3T1 | 25/50 | |
| 3T2 | PCM-3T2 | PSM-3T2 | 25/50 | |
| 3T3 | PCM-3T3 | PSM-3T3 | 25/50 | |
| 4T1 | PCM-4T1 | PSM-4T1 | 25/50 | |
| 4T2 | PCM-4T2 | PSM-4T2 | 25/50 | |
| 4T3 | PCM-4T3 | PSM-4T3 | 25/50 | |
| 5T1 | PCM-5T1 | — | 25/50 | |
| 5T2 | PCM-5T2 | — | 25/50 | |
| 5T3 | PCM-5T3 | — | 25/50 | |
| 6T1 | PCM-6T1 | — | 25/50 | |
| 6T2 | PCM-6T2 | — | 25/50 | |
| 6T3 | PCM-6T3 | — | 25/50 | |
| 7T1 | PCM-7T1 | — | 25/50 | |
| 7T2 | PCM-7T2 | — | 25/50 | |
| 7T3 | PCM-7T3 | — | 25/50 | |

†Half length markers available for PCM parts above. To order, substitute PCMH for PCM.

Marker Cards (cont.)

Consecutive Machine Tool - Repeated

| Marker Type | Marker Length In. (mm) | For Max. Wire O.D. |
|-------------|------------------------|--------------------|
| Full | 1.50 (38.1) | 0.38 (9.5) |
| Half | 0.75 (19.1) | 0.19 (4.7) |

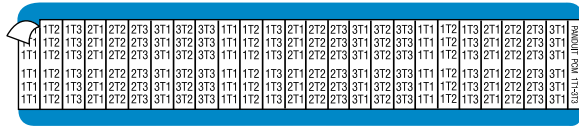

Type PCM

| Legend | Part Number | Mkrs Per Card Full/Half† | Std. Pkg. Qty.* |
|---|------------------|--------------------------|-----------------|
| | GMC1 Vinyl Cloth | | |
| 1T1, 1T2, 1T3 2T1, 2T2, 2T3 3T1, 3T2, 3T3 | PCM-1T1-3T3 | 25/50 | 25 Cards |
| 4T1, 4T2, 4T3 5T1, 5T2, 5T3 6T1, 6T2, 6T3 | PCM-4T1-6T3 | 25/50 | |
| 7T1, 7T2, 7T3 8T1, 8T2, 8T3 9T1, 9T2, 9T3 | PCM-7T1-9T3 | 25/50 | |

†Half length markers available for PCM parts above. To order, substitute PCMH for

Solid Symbols – Misc.



Type PCM and PPM

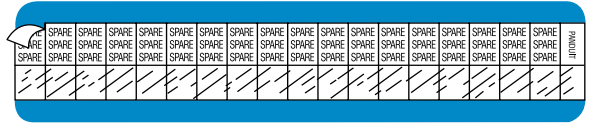

Type PSM

| Legend | Meaning | Part Number | | | Mkrs Per Card Full/Half† | Std. Pkg. Qty.* |
|---------|---------------------|------------------|----------------|---------------------|--------------------------|-----------------|
| | | GMC1 Vinyl Cloth | GMM1 Polyester | GMV3 Self-Lam Vinyl | | |
| A+ | A plus | PCM-A-PLS | — | — | 36/72 | 25 Cards |
| A- | A minus | PCM-A-MNS | — | — | 36/72 | |
| A+, A- | A plus, A minus | PCM-A-PM | — | — | 18/36 | |
| B+ | B plus | PCM-B-PLS | — | — | 36/72 | |
| B- | B minus | PCM-B-MNS | — | — | 36/72 | |
| NEG | Negative | PCM-NEG | — | — | 25/50 | |
| POS | Positive | PCM-POS | — | — | 25/50 | |
| + | Plus | PCM-PLS | PPM-PLS | — | 36/72 | |
| - | Minus | PCM-MIN | PPM-MIN | — | 36/72 | |
| ± | Plus or Minus | PCM-PLM | — | — | 36/72 | |
| PHASE A | — | PCM-APH | — | — | 18/36 | |
| PHASE B | — | PCM-BPH | — | — | 18/36 | |
| PHASE C | — | PCM-CPH | — | — | 18/36 | |
| 1-PHASE | Single Phase | PCM-1PH | — | — | 18/36 | |
| AC | Alternating Current | PCM-AC | PPM-AC | — | 36/72 | |
| BAT | Battery | PCM-BAT | — | — | 25/50 | |
| COM | Common | PCM-COM | — | — | 25/50 | |
| DC | Direct Current | PCM-DC | PPM-DC | — | 36/72 | |
| GRD | Ground | PCM-GRD | — | — | 25/50 | |
| GND | Ground | PCM-GND | PPM-GND | — | 25/50 | |
| HOT | Hot | PCM-HOT | — | — | 25/50 | |
| IGN | Ignition | PCM-IGN | — | — | 25/50 | |
| IN | In | PCM-IN | — | — | 36/72 | |
| LINE | Line | PCM-LIN | — | — | 18/36 | |
| LOAD | Load | PCM-LOAD | — | — | 18/36 | |
| NEUT | Neutral | PCM-NEUT | — | — | 18/36 | |
| OUT | Out | PCM-OUT | — | — | 25/50 | |
| SPARE | Spare | PCM-SPR | — | PSM-SPARE | 18/36 | |
| SS | — | PCM-SS | — | — | 36/72 | |
| ~ | Cycle Symbol | PCM-CYS | — | — | 36/72 | |
| ⊥ | Ground | PCM-GRS | — | — | 36/72 | |
| → | Horizontal Arrow | PCM-HRA | — | — | 36/72 | |
| ↑ | Vertical Arrow | PCM-INDA | — | — | 36/72 | |

†Half length markers available for PCM and above. To order, substitute PCMH for PCM.

Marker Cards (cont.)

Solid Voltage Symbols

| Marker Type | Marker Length In. (mm) | For Max. Wire O.D. |
|-------------|------------------------|--------------------|
| Full | 1.50 (38.1) | 0.38 (9.5) |
| Half | 0.75 (19.1) | 0.19 (4.7) |



Type PCM and PPM

| Legend | Part Number | | Mkrs Per Card Full/Half† | Std. Pkg. Qty.* |
|--------|------------------|----------------|--------------------------|-----------------|
| | GMC1 Vinyl Cloth | GMM1 Polyester | | |
| 6V | PCM-6V | — | 36/72 | 25 Cards |
| 12V | PCM-12V | — | 25/50 | |
| 24V | PCM-24V | — | 25/50 | |
| 110V | PCM-110V | — | 20/40 | |
| 115V | PCM-115V | — | 20/40 | |
| 120V | PCM-120V | — | 20/40 | |
| 220V | PCM-220V | PPM-220V | 20/40 | |
| 230V | PCM-230V | — | 20/40 | |
| 240V | PCM-240V | — | 20/40 | |
| 277V | PCM-277V | — | 20/40 | |
| 460V | PCM-460V | — | 20/40 | |
| 480V | PCM-480V | — | 20/40 | |

*Order number of cards required in multiples of Std. Pkg. Qty.

†Half length markers available for PCM parts above. To order, substitute PCMH for PCM.

Number Combination Package - 1 Card Each Number

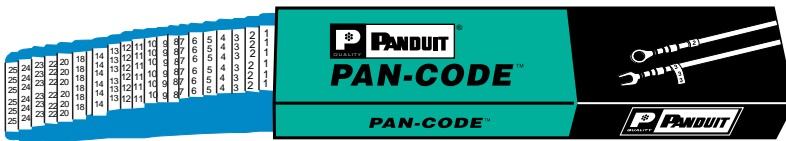

| Legend | Part Number | | Mkrs Per Card Full/Half† | Std. Pkg. Qty.* |
|--------------|------------------|----------------|--------------------------|----------------------------|
| | GMC1 Vinyl Cloth | GMM1 Polyester | | |
| 1 thru 25 | PCMCP-1-25 | PPMCP-1-25 | 36/72 | 1 Pkg. (25 cards per pkg.) |
| 26 thru 50 | PCMCP-26-50 | PPMCP-26-50 | 36/72 | |
| 51 thru 75 | PCMCP-51-75 | PPMCP-51-75 | 36/72 | |
| 76 thru 100 | PCMCP-76-100 | PPMCP-76-100 | 36/72 | |
| 101 thru 125 | PCMCP-101-125 | PPMCP-101-125 | 25/50 | |
| 126 thru 150 | PCMCP-126-150 | PPMCP-126-150 | 25/50 | |
| 151 thru 175 | PCMCP-151-175 | PPMCP-151-175 | 25/50 | |
| 176 thru 200 | PCMCP-176-200 | PPMCP-176-200 | 25/50 | |
| 201 thru 225 | PCMCP-201-225 | PPMCP-201-225 | 25/50 | |
| 226 thru 250 | PCMCP-226-250 | PPMCP-226-250 | 25/50 | |
| 251 thru 275 | PCMCP-251-275 | PPMCP-251-275 | 25/50 | |
| 276 thru 300 | PCMCP-276-300 | PPMCP-276-300 | 25/50 | |
| 301 thru 325 | PCMCP-301-325 | PPMCP-301-325 | 25/50 | |
| 326 thru 350 | PCMCP-326-350 | PPMCP-326-350 | 25/50 | |
| 351 thru 375 | PCMCP-351-375 | PPMCP-351-375 | 25/50 | |
| 376 thru 400 | PCMCP-376-400 | PPMCP-376-400 | 25/50 | |
| 401 thru 425 | PCMCP-401-425 | — | 25/50 | |
| 426 thru 450 | PCMCP-426-450 | — | 25/50 | |
| 451 thru 475 | PCMCP-451-475 | — | 25/50 | |
| 476 thru 500 | PCMCP-476-500 | — | 25/50 | |
| 501 thru 525 | PCMCP-501-525 | — | 25/50 | |
| 526 thru 550 | PCMCP-526-550 | — | 25/50 | |
| 551 thru 575 | PCMCP-551-575 | — | 25/50 | |
| 576 thru 600 | PCMCP-576-600 | — | 25/50 | |

†Half length markers available for PCMCP parts above. To order, substitute PCMHCP for PCMCP.

*Order number of packages required in multiples of Std. Pkg. Qty.

Letter Combination Package - 1 Card Each Letter



| Legend | Part Number | | Mkrs Per Card Full/Half | Std. Pkg. Qty.* |
|------------------------|------------------|----------------|-------------------------|----------------------------|
| | GMC1 Vinyl Cloth | GMM1 Polyester | | |
| A thru Z (1 card each) | PCMCP-A-Z | PPMCP-A-Z | 36/72 | 1 Pkg. (26 cards per pkg.) |

†Half length markers available for PCMCP parts above. To order, substitute PCMHCP for PCMCP.

*Order number of packages required in multiples of Std. Pkg. Qty.

Marker Cards (cont.)

Consecutive Numbers and Electrical Symbols

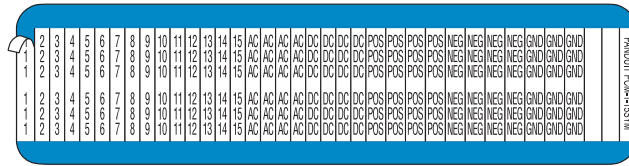

| Legend | Part Number | Marker Size In. (mm) | For Max Wire O.D. | Mkrs Per Card Full/Half † | Std. Pkg. Qty.* |
|---|--------------------|--|--------------------------|---------------------------------|-----------------------|
| | GMC1 Vinyl Cloth | | | | |
| (1) ea. 1-15 (4) ea. AC, DC, POS, NEG. (3) ea. GND (2) ea. Blank | PCM-1-15SYM | Full 0.22 x 1.38 (5.6 x 34.9) Half 0.22 x 0.69 (5.6 x 17.4) | 0.38 (9.5) 0.19 (4.7) | 36/ 72 | 25 Cards |

*Order number of cards required in multiples of Std. Pkg. Qty.
†Half length markers available for PCM parts above. To order, substitute PCMH for PCM.

Blank Write-on Markers Material: GMV3 Self-Laminating Vinyl

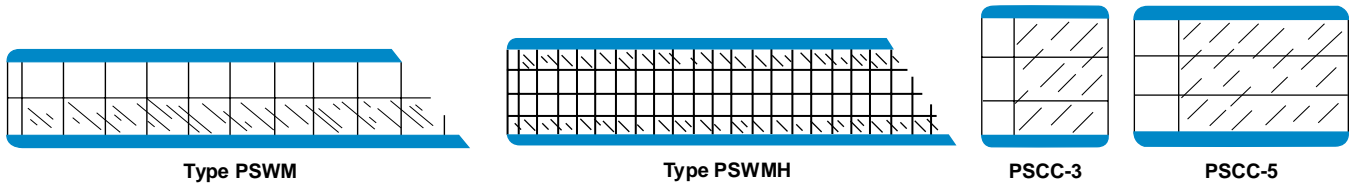

| Max. Wire O.D. In. (mm) | Max. Flat Cable In. (mm) | Part Number | Write-On Area Width x Length In. (mm) | Marker Size Width x Length In. (mm) | Markers Per Card | Std. Pkg. Qty.* | |
|-------------------------------|--------------------------------|-------------------|---|---|------------------------|-----------------------|---|
| 0.25 (6.3) | — | PSWM-375 | 0.38 x 0.75 (9.5 x 19.1) | 0.38 x 1.50 (9.5 x 38.1) | 25 | 25 Cards | |
| | | PSWM-750 | 0.75 x 0.75 (19.1 x 19.1) | 0.75 x 1.50 (19.1 x 38.1) | 12 | | |
| | | PSWM-1500 | 1.50 x 0.75 (38.1 x 19.1) | 1.50 x 1.50 (38.1 x 38.1) | 6 | | |
| 0.13 (3.2) | — | PSWMH-375 | 0.38 x 0.38 (9.5 x 9.5) | 0.38 x 0.75 (9.5 x 19.1) | 50 | | |
| | | PSWMH-750 | 0.75 x 0.38 (19.1 x 9.5) | 0.75 x 0.75 (19.1 x 19.1) | 24 | | |
| | | PSWMH-1500 | 1.50 x 0.38 (38.1 x 9.5) | 1.50 x 0.75 (38.1 x 19.1) | 12 | | |
| 0.69 (17.5) | 1.00 (25.4) | PSCC-3 | 1.00 x 0.75 (25.4 x 19.1) | 1.00 x 3.00 (25.4 x 76.2) | 3 | | 3 |
| 1.25 (31.8) | 1.88 (47.6) | PSCC-5 | 1.00 x 1.00 (25.4 x 25.4) | 1.00 x 5.00 (25.4 x 127.0) | 3 | | |

*Order number of cards required in multiples of Std. Pkg. Qty.

Miniature Markers

Material: GMT TEDLAR ▲

- For smaller diameter wires
- Black legend on white background



Numbers

| Legend | Part Number | Marker Size W X L In. (mm) | Max. Wire O.D. In. (mm) | Markers Per Card | Std. Pkg. Qty.* |
|------------|-----------------------|----------------------------------|-------------------------------|------------------------|-----------------------|
| 0 | PM-0 | 0.18 x 0.50 (4.6 x 12.7) | 0.13 (3.2) | 150 | 25 Cards |
| 1 | PM-1 | | | 150 | |
| Thru 25 | Thru PM-25 | | | 150 | |
| 0 Thru 49 | PM-0-49 | | | (3) ea. | |
| 50 Thru 99 | PM-50-99 | | | (3) ea. | |

Letters

| Legend | Part Number | Marker Size W X L In. (mm) | Max. Wire O.D. In. (mm) | Markers Per Card | Std. Pkg. Qty.* |
|----------------------|---------------|----------------------------------|-------------------------------|------------------------|-----------------------|
| A Thru T U thru Z | PM-A-Z | 0.18 x 0.50 (4.6 x 12.7) | 0.13 (3.2) | (6) ea. (5) ea. | 25 Cards |

*Order number of cards required in multiples of Std. Pkg. Qty.

▲TEDLAR is the registered trademark of E. I. DuPont Co.



Conductor Identification Labels

Material: GMY Polyester

- Identification of equipment terminals and terminations of certain designated conductors, ref. IEC 445:1988, DIN EN 60445, DIN 40009, DIN 40011, DIN 40012 and further developments
- Resistant to temperatures up to 275°F (135°C)

| Style | Marker Diameter In. (mm) | Markers Per Card |
|-------|--------------------------|------------------|
| A | 0.49 (12.5) | 20 |
| B | 0.63 (16.0) | 20 |
| C | 0.79 (20.0) | 10 |
| D | 0.98 (25.0) | 10 |
| E | 1.24 (31.5) | 10 |

| Part Number | | | | | Identification of Conductor—Ends (ref. IEC445, DIN EN 60445) | Legend | Color (Legend/Background) | Std. Pkg. Qty.* |
|-------------|------------|------------|------------|------------|--|--|---|-----------------|
| Style A | Style B | Style C | Style D | Style E | | | | |
| PESS-A-L1 | PESS-B-L1 | PESS-C-L1 | PESS-D-L1 | PESS-E-L1 | Alternating Current | Outer conductor 1 Outer conductor 2 Outer conductor 3 Neutral conductor | White/Black White/Black White/Black White/Blue | 10 cards |
| PESS-A-L2 | PESS-B-L2 | PESS-C-L2 | PESS-D-L2 | PESS-E-L2 | | | | |
| PESS-A-L3 | PESS-B-L3 | PESS-C-L3 | PESS-D-L3 | PESS-E-L3 | | | | |
| PESS-A-N | PESS-B-N | PESS-C-N | PESS-D-N | PESS-E-N | | | | |
| PESS-A-L+ | PESS-B-L+ | PESS-C-L+ | PESS-D-L+ | PESS-E-L+ | Direct Current | Positive Negative Middle conductor | White/Black White/Black White/Blue | |
| PESS-A-L- | PESS-B-L- | PESS-C-L- | PESS-D-L- | PESS-E-L- | | | | |
| PESS-A-M | PESS-B-M | PESS-C-M | PESS-D-M | PESS-E-M | | | | |
| PESS-A-PE | PESS-B-PE | PESS-C-PE | PESS-D-PE | PESS-E-PE | Protective conductor | | Black/Green and Yellow | |
| PESS-A-PU | PESS-B-PU | PESS-C-PU | PESS-D-PU | PESS-E-PU | Protective conductor no earth | | | |
| PESS-A-PEN | PESS-B-PEN | PESS-C-PEN | PESS-D-PEN | PESS-E-PEN | Neutral conductor with protective-function (PEN conductor) | | | |
| PESS-A-E | PESS-B-E | PESS-C-E | PESS-D-E | PESS-E-E | Earth | | White/Black | |
| PESS-A-TE | PESS-B-TE | PESS-C-TE | PESS-D-TE | PESS-E-TE | Parasitic current | | | |
| PESS-A-MM | PESS-B-MM | PESS-C-MM | PESS-D-MM | PESS-E-MM | Ground | | | |
| PESS-A-AQ | PESS-B-AQ | PESS-C-AQ | PESS-D-AQ | PESS-E-AQ | Equal Potential connection | | | |

| Part Number | | | | | Machinery Materials Identification (ref. DIN 40011) | Legend | Color (Legend/Background) | Std. Pkg. Qty.* |
|-------------|-----------|-----------|-----------|-----------|---|--------|---------------------------|-----------------|
| Style A | Style B | Style C | Style D | Style E | | | | |
| PESS-A-PS | PESS-B-PS | PESS-C-PS | PESS-D-PS | PESS-E-PS | Direct current positive | | Black/White | 10 Cards |
| PESS-A-NS | PESS-B-NS | PESS-C-NS | PESS-D-NS | PESS-E-NS | Direct current negative | | | |
| PESS-A-SS | PESS-B-SS | PESS-C-SS | PESS-D-SS | PESS-E-SS | Safety function | | | |
| PESS-A-ES | PESS-B-ES | PESS-C-ES | PESS-D-ES | PESS-E-ES | Earth | | | |
| PESS-A-FS | PESS-B-FS | PESS-C-FS | PESS-D-FS | PESS-E-FS | Parasitic current | | | |
| PESS-A-SG | PESS-B-SG | PESS-C-SG | PESS-D-SG | PESS-E-SG | Ground | | | |
| PESS-A-SU | PESS-B-SU | PESS-C-SU | PESS-D-SU | PESS-E-SU | Protective isolation | | | |
| PESS-A-CE | PESS-B-CE | PESS-C-CE | PESS-D-CE | PESS-E-CE | Certified | | | |

| Part Number | | | | | Machinery Materials Identification (ref. DIN 40012) | Legend | Color (Legend/Background) | Std. Pkg. Qty.* |
|-------------|------------|------------|------------|------------|---|--------|---------------------------|-----------------|
| Style A | Style B | Style C | Style D | Style E | | | | |
| PESS-A-EX1 | PESS-B-EX1 | PESS-C-EX1 | PESS-D-EX1 | PESS-E-EX1 | Explosion Protection | | Black/White | 10 Cards |
| PESS-A-EX2 | PESS-B-EX2 | PESS-C-EX2 | PESS-D-EX2 | PESS-E-EX2 | Explosion Protection | | | |
| PESS-A-SCH | PESS-B-SCH | PESS-C-SCH | PESS-D-SCH | PESS-E-SCH | Firedamp Protection | | | |

*Order number of cards required in multiples of Std. Pkg. Qty.

Marker Tape

Wire Marker Tape Dispenser

Material: GMM1 Polyester



EASY TO USE...

1. Open cover, pull out desired length of tape
2. Close cover and press firmly to cut tape

TO RELOAD TAPE...

1. Open cover, drop in tape

UNIQUE DESIGN DISPENSER...

- The tape is cut by depressing the cover and is not torn off by hand. This provides a clean cut-off, with no serrations and insures better adhesion.
- Holds 10 rolls of tape
- Legend is visible through cover window for fast selection
- Tough polypropylene construction, single piece design

Each Roll Features

Universal spool size makes tape usable in other dispenser systems. The tape can be cut to any length so you only use what you actually need. Tabbed end at the beginning of the roll for easier starting



| Part Number | Legend | Roll Length | Rolls per Legend per Pkg. | Std. Pkg. Qty.* |
|------------------|--|-----------------|---------------------------|-----------------|
| DISPENSER | | | | |
| PMD | (Empty Dispenser) | — | — | 1 |
| PMD-0-9 | Dispenser filled, legend 0 thru 9 | 8 ft. (2.4m) | 1 | 1 |
| PMD-NEMA | Dispenser filled, solid colors shown below | | | |

*Order number of dispensers required in multiples of Std. Pkg. Qty.

TAPE

| | | | | |
|-------------------------------------|--|-----------------|----|----------------------|
| PMDR-0-9 thru PMDR-90-99 | 0 thru 9 thru 90 thru 99 | 8 ft. (2.4m) | 1 | 1 Pkg. (10 rolls) |
| PMDR-0 PMDR-1 thru PMDR-9 | 0 1 thru 9 | 8 ft. (2.4m) | 10 | 10 Rolls |
| PMDR-A thru PMDR-Z | A thru Z | 8 ft. (2.4m) | 10 | 10 Rolls |
| PMDR-L1 PMDR-L2 PMDR-L3 | L1 L2 L3 | 8 ft. (2.4m) | 10 | 10 Rolls |
| PMDR-T1 PMDR-T2 PMDR-T3 | T1 T2 T3 | 8 ft. (2.4m) | 10 | 10 Rolls |
| PMDR-CYS PMDR-GRS PMDR-MIN PMDR-PLS | (Cycle Symbol) (Ground Symbol) (Minus Symbol) (Plus Symbol) | 8 ft. (2.4m) | 10 | 10 Rolls |
| PMDR-NEMA | One of each of the NEMA colors featured below | 8 ft. (2.4m) | 1 | 1 Pkg. (10 Rolls) |
| PMDR-BLK | (Black) | 8 ft. (2.4m) | 10 | 10 Rolls |
| PMDR-BL | (Light Blue) | | | |
| PMDR-BRN | (Brown) | | | |
| PMDR-GRY | (Gray) | | | |
| PMDR-GRN | (Light Green) | | | |
| PMDR-ORN | (Orange) | | | |
| PMDR-PUR | (Purple) | | | |
| PMDR-RED | (Red) | | | |
| PMDR-WHT | (White) | | | |
| PMDR-YEL | (Yellow) | | | |
| PMDR-YEL-GRN | (Yellow/Green Striped) | | | |

Legend Height: 1/8" (3.2mm)

*Order number of rolls required in multiples of Std. Pkg. Qty.

Self-Laminating Marker Dispenser

Material: GMV3 Self-Laminating Vinyl



- Dispenser made of tough polypropylene
- Rolls load easily into reusable dispenser
- Mark with Panduit Marking Pens found on [page 137](#)

| Part Number | Description | Write-On Area Width x Length In. (mm) | Total Marker Width x Length In. (mm) | Markers Per Roll | Std. Pkg. Qty.* |
|----------------------|--|---------------------------------------|--------------------------------------|------------------|-----------------|
| DISPENSER KIT | | | | | |
| PLD-1 | (1) Dispenser, (1) PLDR-1 Tape, (1) PFX-0 Pen | 1.00 x 0.38 (25.4 x 9.5) | 1.00 x 1.50 (25.4 x 38.1) | 200 | 1 Kit |
| PLD-2 | (1) Dispenser, (1) PLDR-2 Tape, (1) PFX-0 Pen | 1.00 x 0.75 (25.4 x 19.1) | 1.00 x 3.00 (25.4 x 76.2) | 100 | 1 Kit |
| TAPE | | | | | |
| PLDR-1 | For cable O.D. up to 1/4" (6.3 mm); Flat cable up to 1/2" (12.7 mm) wide | 1.00 x 0.38 (25.4 x 9.5) | 1.00 x 1.50 (25.4 x 38.1) | 200 | 1 Roll |
| PLDR-2 | For cable O.D. up to 11/16" (17.5 mm); Flat cable up to 1" (25.4 mm) wide | 1.00 x 0.75 (25.4 x 19.1) | 1.00 x 3.00 (25.4 x 76.2) | 100 | 1 Roll |

*Order number of kits or rolls required in multiples of Std. Pkg. Qty.

NOTE: Empty dispenser not sold separately

Slip-On Wire Markers

Material: GMV11 Vinyl Extrusion

- Fully encircle wires, ensuring permanent identification for wire marking applications
- Durable PVC material is impervious to most chemicals and solvents and can be used in most harsh environments
- Available with white or yellow background



| Wire O.D. In. (mm) | 0.05 - 0.12 (1.3 - 3.0) | 0.10 - 0.20 (2.5 - 5.1) | 0.16 - 0.39 (4.1 - 9.9) | 0.32 - 0.63 (8.1 - 16.0) | 0.55 - 0.98 (14.0 - 24.9) |
|-----------------------|----------------------------|----------------------------|----------------------------|-----------------------------|------------------------------|
| AWG | 22 - 16 | 16 - 10 | 10 - 4 | 6 - 00 | 0 - 350MCM |

Standard Pack

| Legend | Part Number† | | | | |
|---------------------|----------------------------|----------------------------|----------------------------|-------------------------------|------------------------------|
| A | SM02W-A | SM1W-A | SM2W-A | SM3W-A | SM4W-A |
| B | SM02W-B | SM1W-B | SM2W-B | SM3W-B | SM4W-B |
| Thru | Thru | Thru | Thru | Thru | Thru |
| Z | SM02W-Z | SM1W-Z | SM2W-Z | SM3W-Z | SM4W-Z |
| A-J | SM02W-A-J | SM1W-A-J | SM2W-A-J | — | — |
| K-T | SM02W-K-T | SM1W-K-T | SM2W-K-T | — | — |
| U-Z, +, -, /, Blank | SM02W-U-Z | SM1W-U-Z | SM2W-U-Z | — | — |
| 0 | SM02W-0 | SM1W-0 | SM2W-0 | SM3W-0 | SM4W-0 |
| 1 | SM02W-1 | SM1W-1 | SM2W-1 | SM3W-1 | SM4W-1 |
| Thru | Thru | Thru | Thru | Thru | Thru |
| 9 | SM02W-9 | SM1W-9 | SM2W-9 | SM3W-9 | SM4W-9 |
| 0-9 | SM02W-0-9 | SM1W-0-9 | SM2W-0-9 | — | — |
| + | SM02W-PLS | SM1W-PLS | SM2W-PLS | SM3W-PLS | SM4W-PLS |
| - | SM02W-MNS | SM1W-MNS | SM2W-MNS | SM3W-MNS | SM4W-MNS |
| / | SM02W-SLH | SM1W-SLH | SM2W-SLH | SM3W-SLH | SM4W-SLH |
| (Ground Symbol) | SM02W-GND | SM1W-GND | SM2W-GND | SM3W-GND | SM4W-GND |
| Blank | SM02W-BLNK | SM1W-BLNK | SM2W-BLNK | SM3W-BLNK | SM4W-BLNK |
| Std. Pkg. Contents | 10 strips of 25 markers | 10 strips of 25 markers | 10 strips of 25 markers | 1 bag of 100 loose markers | 1 bag of 20 loose markers |
| Std. Pkg. Qty.* | 1 Pkg. | 1 Pkg. | 1 Pkg. | 1 Pkg. | 1 Pkg. |

Bulk Pack

| Legend | Part Number† | | | | |
|--------------------|----------------------------|----------------------------|----------------------------|-------------------------------|-------------------------------|
| A | SMB02W-A | SMB1W-A | SMB2W-A | SMB3W-A | SMB4W-A |
| B | SMB02W-B | SMB1W-B | SMB2W-B | SMB3W-B | SMB4W-B |
| Thru | Thru | Thru | Thru | Thru | Thru |
| Z | SMB02W-Z | SMB1W-Z | SMB2W-Z | SMB3W-Z | SMB4W-Z |
| 0 | SMB02W-0 | SMB1W-0 | SMB2W-0 | SMB3W-0 | SMB4W-0 |
| 1 | SMB02W-1 | SMB1W-1 | SMB2W-1 | SMB3W-1 | SMB4W-1 |
| Thru | Thru | Thru | Thru | Thru | Thru |
| 9 | SMB02W-9 | SMB1W-9 | SMB2W-9 | SMB3W-9 | SMB4W-9 |
| + | SMB02W-PLS | SMB1W-PLS | SMB2W-PLS | SMB3W-PLS | SMB4W-PLS |
| - | SMB02W-MNS | SMB1W-MNS | SMB2W-MNS | SMB3W-MNS | SMB4W-MNS |
| / | SMB02W-SLH | SMB1W-SLH | SMB2W-SLH | SMB3W-SLH | SMB4W-SLH |
| (Ground Symbol) | SMB02W-GND | SMB1W-GND | SMB2W-GND | SMB3W-GND | SMB4W-GND |
| Blank | SMB02W-BLNK | SMB1W-BLNK | SMB2W-BLNK | SMB3W-BLNK | SMB4W-BLNK |
| Bulk Pkg. Contents | 1 strip of 1000 markers | 1 strip of 1000 markers | 1 strip of 1000 markers | 1 bag of 250 loose markers | 5 bags of 20 loose markers |
| Bulk Pkg. Qty.* | 1 Pkg. | 1 Pkg. | 1 Pkg. | 1 Pkg. | 1 Pkg. |

*Order number of packages required in multiples of Std. Pkg. Qty.

†Part numbers shown have white background. To order yellow background replace "W" with "Y". For example, SM02Y-A has yellow background.

Clip-On Wire Markers

Clip-On Wire Markers

Material: GMACT Acetal

- Easy to install – markers snap on wire
- Can be removed and reused
- Exceed requirements of MIL-H-5606 and MIL-L-7808
- Available with white or yellow background



Refer to Wire Size Selection Guide on [page 196](#) to review diameters of commonly used wire and cable.

| Wire O.D. In. (mm) | 0.08 - 0.10 (2.0 - 2.5) | 0.11 - 0.13 (2.8 - 3.3) | 0.13 - 0.15 (3.3 - 3.8) | 0.19 - 0.23 (4.8 - 5.8) | 0.23 - 0.37 (5.8 - 9.4) | 0.23 - 0.37 (5.8 - 9.4) | 0.36 - 0.45 (9.1 - 11.4) | 0.45 - 0.62 (11.4 - 15.7) |
|-----------------------|----------------------------|----------------------------|----------------------------|----------------------------|----------------------------|----------------------------|-----------------------------|------------------------------|
|-----------------------|----------------------------|----------------------------|----------------------------|----------------------------|----------------------------|----------------------------|-----------------------------|------------------------------|

| Legend | Part Number† | | | | | | | |
|---|--------------|-----------|-----------|-----------|--|--|--|-----------|
| A | PCA07-A | PCA11-A | PCA13-A | PCA18-A | PCA23-A | – | PCA36-A | PCA45-A |
| B | PCA07-B | PCA11-B | PCA13-B | PCA18-B | PCA23-B | – | PCA36-B | PCA45-B |
| Thru | Thru | Thru | Thru | Thru | Thru | – | Thru | Thru |
| Z | PCA07-Z | PCA11-Z | PCA13-Z | PCA18-Z | PCA23-Z | – | PCA36-Z | PCA45-Z |
| A-J | PCA07-A-J | PCA11-A-J | PCA13-A-J | PCA18-A-J | – | – | – | – |
| K-T | PCA07-K-T | PCA11-K-T | PCA13-K-T | PCA18-K-T | – | – | – | – |
| U-Z | PCA07-U-Z | PCA11-U-Z | PCA13-U-Z | PCA18-U-Z | – | – | – | – |
| A-D | – | – | – | – | – | PCA23-A-D | PCA36-A-D | PCA45-A-D |
| E-H | – | – | – | – | – | PCA23-E-H | PCA36-E-H | PCA45-E-H |
| I-L | – | – | – | – | – | PCA23-I-L | PCA36-I-L | PCA45-I-L |
| M-P | – | – | – | – | – | PCA23-M-P | PCA36-M-P | PCA45-M-P |
| Q-T | – | – | – | – | – | PCA23-Q-T | PCA36-Q-T | PCA45-Q-T |
| U-X | – | – | – | – | – | PCA23-U-X | PCA36-U-X | PCA45-U-X |
| Y-Z | – | – | – | – | – | PCA23-Y-Z | PCA36-Y-Z | PCA45-Y-Z |
| 0 | PCA07-0 | PCA11-0 | PCA13-0 | PCA18-0 | PCA23-0 | – | PCA36-0 | PCA45-0 |
| 1 | PCA07-1 | PCA11-1 | PCA13-1 | PCA18-1 | PCA23-1 | – | PCA36-1 | PCA45-1 |
| Thru | Thru | Thru | Thru | Thru | Thru | – | Thru | Thru |
| 9 | PCA07-9 | PCA11-9 | PCA13-9 | PCA18-9 | PCA23-9 | – | PCA36-9 | PCA45-9 |
| 0-9 | PCA07-0-9 | PCA11-0-9 | PCA13-0-9 | PCA18-0-9 | – | – | – | – |
| 0-3 | – | – | – | – | – | PCA23-0-3 | PCA36-0-3 | PCA45-0-3 |
| 4-7 | – | – | – | – | – | PCA23-4-7 | PCA36-4-7 | PCA45-4-7 |
| 8, 9, +, - | – | – | – | – | – | PCA23-8-9 | PCA36-8-9 | PCA45-8-9 |
| + | PCA07-PLS | PCA11-PLS | PCA13-PLS | PCA18-PLS | PCA23-PLS | – | PCA36-PLS | PCA45-PLS |
| – | PCA07-MIN | PCA11-MIN | PCA13-MIN | PCA18-MIN | PCA23-MIN | – | PCA36-MIN | PCA45-MIN |
| 30 Clips per application wand = 300 Clips total/pkg. | | | | | 20 Clips per wand = 60 clips total/pkg. | 20 Clips per wand = 80 clips total/pkg. | 15 Clips per wand = 60 clips total/pkg. | |
| 10 Wands/Pkg. | | | | | 3 Wands/Pkg. | 4 Wands/Pkg. | 4 Wands/Pkg. | |
| Std. Pkg. Qty.* = 1 pkg. | | | | | | | | |

*Order number of packages required in multiples of Std. Pkg. Qty.

†Part numbers shown have white background. To order yellow background replace "PCA" with "PCAY". For example, PCAY07-A has yellow background.

Cable Marking Products

Selection of Styles



Self-Laminating Cable Marker Holders Page 152

Durable tag to mark large cables and cable bundles. Holders can be used with labels printed on any printer, or legend can be hand-written directly onto holder. Clear overlamine protects legend.



Clear Heat Shrink Tubing Page 153

Clear heat shrink is applied over label to protect legends on wires and cables. Available for diameters from 0.19" - 2.00" (4.8 mm - 50.8 mm).



Fiber Optic Cable Marker Tags Page 154

Self-laminating tag for marking fiber optic cable in manhole and indoor environments. Clear overlamine protects legend.



Ground Warning Tags Page 154

UV resistant tags provide ground clamp warning.



Fiber Optic Conduit Markers Page 155

Durable markers available in adhesive and snap-on styles.



Underground Hazard Tape Page 155

Used to warn of buried cable lines, these non-adhesive tapes will not biodegrade. Available in detectable aluminum foil laminate and polyethylene materials in a variety of legends, colors and sizes.

Self-Laminating Cable Marker Holders for Large Cables and Bundles



- Durable tag to mark a wide range of cables and cable bundles
- Can be used with printer generated labels or hand-written
- Attaches easily with Panduit intermediate or standard cross-section nylon cable ties or Panduit **TAK-TY™** Hook and Loop Cable Ties
- Ideal for use with Panduit hand-held printers, such as the LS3E, LS5 and LS5E
- Clear overlaminates protect legend
- Can be applied as a wrap-around marker (parallel to cable) or flag marker (45° or 90° to cable)
- Available in white, yellow, orange, gray and brown
- Large label area provides ample room for complex labeling schemes

Marker Holders

| Part Number | Color | Size In. (mm) | Holders Per Pkg. | Std. Pkg. Qty.* |
|-------------|--------|------------------------------|------------------|-----------------|
| SLCT-WH | White | 3.00 x 1.31 (76.2 x 33.3) | 25 | 1 Pkg. |
| SLCT-YL | Yellow | | | |
| SLCT-OR | Orange | | | |
| SLCT-IG | Gray | | | |
| SLCT-BR | Brown | | | |

*Order number of packages required in multiples of Std. Pkg. Qty.

Recommended Labels

| Part Number | Printer Used | Size In. (mm) | Color | Std. Pkg. Qty.* |
|-------------|--------------------|----------------------------------|-------------|------------------------|
| L3PL3WH | Panduit LS3E | 2.00 x 1.00 (50.8 x 25.4) | White | 1 Roll (100 Labels) |
| L3PL3CL | | | Clear | |
| LS5-33 | Panduit LS5 / LS5E | 1.00 x 40 ft. (25.4 x 12.2 m) | Black/White | 1 Cartridge |
| LS5-30 | | | Black/Clear | |
| PLL-17-Y2-1 | Laser | 1.88 x 0.83 (47.6 x 21.1) | White | 1000 Labels |
| JL41PO-0.5 | Ink Jet | 2.00 x 0.90 (50.8 x 22.9) | White | 500 Labels |
| PDL-301 | Dot-Matrix | 2.00 x 0.90 (50.8 x 22.9) | White | 1000 Labels |

* For LS3E Labels, order number of rolls required in multiples of Std. Pkg. Qty.
 For LS5 Cartridges, order number of cartridges required in multiples of Std. Pkg. Qty.
 For Laser, Ink Jet and Dot-Matrix Labels, order number of labels required in multiples of Std. Pkg. Qty.

Cable Ties

| Part Number | Max. Bundle Diameter In. (mm) | Min. Loop Tensile Strength Lbs. (N) | Std. Pkg. Qty.* |
|---|-------------------------------|-------------------------------------|-----------------|
| PAN-TY® Nylon Self-Locking Cable Ties | | | |
| PLT1.5L-C | 1.38 (35) | 40 (178) | 100 |
| PLT2L-C | 2.00 (51) | | |
| PLT3L-C | 3.00 (76) | | |
| PLT4L-C | 4.00 (102) | | |
| PLT2S-C | 1.88 (48) | 50 (222) | 100 |
| PLT3S-C | 3.00 (76) | | |
| PLT4S-C | 4.00 (102) | | |
| PLT5S-C | 5.00 (127) | | |
| TAK-TY® Hook and Loop Cable Ties | | | |
| HLT2L-X0† | 1.90 (48) | 40 (178) | 10 |
| HLT3L-X0† | 3.20 (81) | | |
| TAK-TY® Hook and Loop Continuous 15 Ft. Roll | | | |
| HLM-15R0† | N/A | 18 (80) | 1 Roll |

*Order number of ties required in multiples of Std. Pkg. Qty.
 †TAK-TY parts shown are black, contact factory for part number information on other colors

Create Custom Cable Markers Quickly and Easily — On-Site!



1. Print label with the LS3E Hand-Held Dot-Matrix Printer or print label on any other printer. When a printer is not available, legend can also be written directly on marker holder.



2. Apply label to marker holder.



3. Remove liner on overlaminates flap to expose adhesive.



4. Fold down overlaminates flap to protect label.



5. Attach to cable bundle with Panduit cable ties.

Clear Heat Shrink Tubing for Protected Wire and Cable Marking

- Use with any label to provide protected legends for harsh environments
- Use with Panduit Heat Shrink Tools and Accessories shown on [page 123](#)



- Available in 3 package sizes
- Material: Clear 2:1 Polyolefin
- Temperature Range: -67°F to 275°F (-55°C to 135°C)
- Mil Spec: MIL-I 23053/5 Class 2
- Shrink Temperature: 248°F (120°C)

| Heat Shrink Tubing | | | | | Suggested Labels | | | |
|--------------------|------------------------------|--------------------|-----------------|-----------------|--|---|---|---|
| Part Number | Nominal Cable O.D.* In. (mm) | Length | Pieces Per Pkg. | Std. Pkg. Qty.* | Printer Used | Panduit Label Part Number | Label Width x Length In. (mm) | Label Std. Pkg. Qty.* |
| HSTT38-YC | 0.19 - 0.38 (4.8 - 9.5) | 6" (152 mm) | 12 | 1 Pkg. | Ink Jet Thermal Transfer Dot-Matrix | JL412PO-1 TTC4T-10 PDL-189 | 1.38 x 0.19 (34.9 x 4.8) 0.65 x 0.20 (16.5 x 5.1) 0.65 x 0.20 (16.5 x 5.1) | 1000 Labels 10,000 Labels 5000 Labels |
| HSTT38-48-QC | | 4' (1.2 m) Piece | 25 | 25 Pieces | | | | |
| HSTT38-QC | | 25' (7.5 m) Reel | 1 | 1 Reel | | | | |
| HSTT50-YC | 0.25 - 0.50 (6.4 - 12.7) | 6" (152 mm) | 10 | 1 Pkg. | LS3E Laser Ink Jet Thermal Transfer Dot-Matrix | LC-7 PLL-14-PO-5 JL412PO-1 TTC6T-10 PDL-190 | 1.00 x 0.28 (25.4 x 7.0) 1.50 x 0.25 (38.1 x 6.4) 1.38 x 0.19 (34.9 x 4.8) 0.90 x 0.25 (22.9 x 6.4) 0.75 x 0.25 (19.1 x 6.4) | 1 Roll (500 Labels) 5000 Labels 1000 Labels 10,000 Labels 5000 Labels |
| HSTT50-48-5C | | 4' (1.2 m) Piece | 5 | 5 Pieces | | | | |
| HSTT50-QC | | 25' (7.5 m) Reel | 1 | 1 Reel | | | | |
| HSTT75-YC | 0.38 - 0.75 (9.5 - 19.1) | 6" (152 mm) | 8 | 1 Pkg. | LS3E Laser Ink Jet Thermal Transfer Dot-Matrix | LC-9 PLL-8-PO-10 JL412PO-1 TTC6T-10 PDL-132 | 1.00 x 0.40 (25.4 x 10.2) 1.00 x 0.38 (25.4 x 9.5) 1.38 x 0.19 (34.9 x 4.8) 0.90 x 0.25 (22.9 x 6.4) 1.25 x 0.38 (31.8 x 9.5) | 1 Roll (500 Labels) 10,000 Labels 1000 Labels 10,000 Labels 5000 Labels |
| HSTT75-48-5C | | 4' (1.2 m) Piece | 5 | 5 Pieces | | | | |
| HSTT75-QC | | 25' (7.5 m) Reel | 1 | 1 Reel | | | | |
| HSTT100-YC | 0.50 - 1.00 (12.7 - 25.4) | 6" (152 mm) | 6 | 1 Pkg. | LS3E Laser Ink Jet Thermal Transfer Dot-Matrix | LC-10 PLL-8-PO-10 JL33PO-2.5 TTC8T-10 PDL-188 | 1.00 x 0.50 (25.4 x 12.7) 1.00 x 0.38 (25.4 x 9.5) 1.44 x 0.50 (36.5 x 12.7) 1.00 x 0.50 (25.4 x 12.7) 1.00 x 0.50 (25.4 x 12.7) | 1 Roll (500 Labels) 10,000 Labels 2500 Labels 10,000 Labels 5000 Labels |
| HSTT100-48-5C | | 4' (1.2 m) Piece | 5 | 5 Pieces | | | | |
| HSTT100-CC | | 100' (30.5 m) Reel | 1 | 1 Reel | | | | |
| HSTT150-48-5C | 0.75 - 1.50 (19.1 - 38.1) | 4' (1.2 m) Piece | 5 | 5 Pieces | LS3E Laser Ink Jet Thermal Transfer Dot-Matrix | LC-4 PLL-10-PO-5 JL33PO-2.5 TTC8T-10 PDL-188 | 1.00 x 0.75 (25.4 x 19.1) 1.00 x 0.75 (25.4 x 19.1) 1.44 x 0.50 (36.5 x 12.7) 1.00 x 0.50 (25.4 x 12.7) 1.00 x 0.50 (25.4 x 12.7) | 1 Roll (500 Labels) 5000 Labels 2500 Labels 10,000 Labels 5000 Labels |
| HSTT150-CC | | 100' (30.5 m) Reel | 1 | 1 Reel | | | | |
| HSTT200-48-5C | 1.00 - 2.00 (25.4 - 50.8) | 4' (1.2 m) Piece | 5 | 5 Pieces | LS3E Laser Ink Jet Thermal Transfer Dot-Matrix | LC-2 PLL-10-PO-5 JL33PO-2.5 TTC8T-10 PDL-188 | 1.00 x 1.00 (25.4 x 25.4) 1.00 x 0.75 (25.4 x 19.1) 1.44 x 0.50 (36.5 x 12.7) 1.00 x 0.50 (25.4 x 12.7) 1.00 x 0.50 (25.4 x 12.7) | 1 Roll (250 Labels) 5000 Labels 2500 Labels 10,000 Labels 5000 Labels |
| HSTT200-LC | | 50' (15.2 m) Reel | 1 | 1 Reel | | | | |

Heat Shrink Data Label Kits

- Fast and easy way to produce subsurface printed custom labels with any dot-matrix printer
- Each kit contains 1000 pre-cut clear heat shrink tubes, 1.50" (38.1 mm) long and 1000 dot-matrix labels listed

| Part Number | Nominal Cable O.D.* In. (mm) | Labels Included | Label Size Width x Length In. (mm) | Std Pkg. Qty.* |
|---------------|------------------------------|-----------------|------------------------------------|----------------|
| HSDL9-12-94 | 0.06 - 0.13 (1.6 - 3.2) | PDL-94 | 0.90 x 0.25 (22.9 x 6.3) | 1000 Kits |
| HSDL9-12-285 | | PDL-285 | 0.90 x 0.25 (22.9 x 6.3) | 1000 Kits |
| HSDL9-25-94 | 0.13 - 0.25 (3.2 - 6.4) | PDL-94 | 0.90 x 0.25 (22.9 x 6.3) | 1000 Kits |
| HSDL9-25-285 | | PDL-285 | 0.90 x 0.25 (22.9 x 6.3) | 1000 Kits |
| HSDL9-37-31 | 0.18 - 0.35 (4.4 - 8.9) | PDL-31 | 1.00 x 0.38 (25.4 x 9.5) | 1000 Kits |
| HSDL9-50-31 | 0.25 - 0.50 (6.4 - 12.7) | PDL-31 | 1.00 x 0.38 (25.4 x 9.5) | 1000 Kits |
| HSDL9-75-20 | 0.38 - 0.75 (9.5 - 19.1) | PDL-20 | 1.00 x 0.38 (25.4 x 9.5) | 1000 Kits |
| HSDL9-100-293 | 0.50 - 1.00 (12.7 - 25.4) | PDL-293 | 1.00 x 0.38 (25.4 x 9.5) | 1000 Kits |

* Refer to Wire Size Selection Guide on [page 196](#) to review diameters of commonly used cables
* Order number required in multiples of Std. Pkg. Qty.

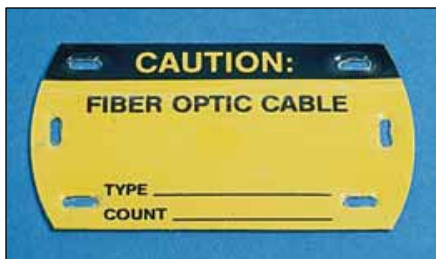

Self-Laminating Fiber Optic Cable Marker Tags

- Durable tag for marking fiber optic cable in manhole and indoor environments
- Clear overlamine protects legend
- Can be marked with Panduit Permanent Marker Pens (see [pg. 137](#))
- Can be installed as a wrap or flag with Panduit Intermediate Cable Ties shown below

(6) slots: 0.31" x 0.13" (7.9 x 3.2 mm)

| Part Number | Material | Size Width x Length In. (mm) | Legend / Background Color | Legend | Tags Per Pkg. | Std. Pkg. Qty.* |
|-------------|----------------------------------|------------------------------|---------------------------|---|---------------|-----------------|
| PST-FO† | GMV4 Self-Laminating Rigid Vinyl | 3.50 x 2.00 (88.9 x 50.8) | Black/Yellow | CAUTION FIBER OPTIC CABLE TYPE _____ COUNT _____ | 5 Tags | 1 Pkg. |
| PST-FOBLNK | | | Yellow | Blank | | |

†Also available in Spanish and Portuguese. To order, add part number suffix -E for Spanish or -P for Portuguese
*Order number of packages required in multiples of Std. Pkg. Qty.



Ground Warning Tags

- U.V. resistant legend is printed on both sides
- Install with Panduit Intermediate Cable Ties shown below
- PT-BLNK tag can be marked with Panduit Permanent Marker Pens (see [pg. 137](#)) for indoor use

(1) slot: 0.13" x 0.63" (3.2 x 15.9 mm)

| Part Number | Material | Size Width x Length In. (mm) | Legend / Background Color | Legend | Tags Per Pkg. | Std. Pkg. Qty.* |
|-------------|-------------------------------|------------------------------|---------------------------|---|---------------|-----------------|
| PT-CGND† | GMPE3 Semi-Rigid Polyethylene | 2.75 x 1.38 (69.9 x 34.9) | Black/Yellow — | WARNING...CABLE TV CO. REPAIR SERVICE | 100 Tags | 1 Pkg. |
| PT-EGND† | | | | WARNING...ELECTRICAL CO. REPAIR SERVICE | | |
| PT-TGND† | | | | WARNING...TELEPHONE CO. REPAIR SERVICE | | |
| PT-GND† | | | | WARNING, GROUND WIRE, DO NOT REMOVE | | |
| PT-BLNK | | | | (Blank) | | |

†Also available in Spanish and Portuguese. To order, add part number suffix -E for Spanish or -P for Portuguese
*Order number of packages required in multiples of Std. Pkg. Qty.

Intermediate Cross Section Cable Ties

- For use with Panduit Cable Markers
- Available in two styles
 - **DOME-TOP® BARB-TY®** Cable Ties have a metal barb
 - **PAN-TY®** Cable Ties are an all plastic, one-piece construction
- Sizes to accommodate up to 4.00" (101.5 mm) bundles
- Indoor and Outdoor materials available

| Part Number | Max. Bundle Diameter In. (mm) | Length In. (mm) | Width In. (mm) | Min. Loop Tensile Strength Lbs. (N) | Material† | Std. Pkg. Qty.* |
|------------------------------------|-------------------------------|-----------------|----------------|-------------------------------------|----------------------------|-----------------|
| DOME-TOP BARB-TY Cable Ties | | | | | | |
| BT1.5I-C | 1.50 (38.1) | 6.1 (155) | 0.14 (3.6) | 40 (178) | Natural Nylon 6.6 (Indoor) | 100 |
| BT2I-C | 2.00 (50.8) | 8.0 (203) | | | | |
| BT3I-C | 3.00 (76.2) | 11.1 (282) | | | | |
| BT4I-C | 4.00 (101.6) | 14.3 (363) | | | | |
| PAN-TY Cable Ties | | | | | | |
| PLT1.5I-C | 1.38 (34.9) | 5.6 (142) | 0.14 (3.6) | 40 (178) | Natural Nylon 6.6 (Indoor) | 100 |
| PLT2I-C | 2.00 (50.8) | 8.0 (203) | | | | |
| PLT2.5I-C | 2.50 (63.5) | 9.7 (246) | | | | |
| PLT3I-C | 3.00 (76.2) | 11.4 (290) | | | | |
| PLT4I-C | 4.00 (101.6) | 14.6 (371) | | | | |

*Order number of pieces required in multiples of Std. Pkg. Qty.
†Ties also available in Black Weather Resistant Nylon 6.6. To order, add "0" to part number, i.e. BT1.5I-C0.

Fiber Optic Conduit Markers



- Durable markers available in adhesive or snap-on styles

| Style | Pipe / Conduit O.D. In. (mm) | Marker Size Width x Length In. (mm) | Markers Per Card | Std. Pkg. Qty.* |
|---------------------------------------|------------------------------|-------------------------------------|------------------|-----------------|
| Adhesive Marker Cards | | | | |
| A | 3.00 (76.2) and Over | 9.00 x 2.25 (228.6 x 57.2) | 1 | 5 Cards |
| B | 1.25 - 3.00 (31.8 - 76.2) | 4.50 x 1.19 (114.3 x 28.6) | 4 | |
| C | 1.25 (31.8) and Under | 2.25 x 0.50 (57.1 x 12.7) | 18 | |
| Snap-On Markers (Non-Adhesive) | | | | |
| M | 2.25 - 6.00 (57.2 - 152.4) | 14.00 x 23.00 (355.6 x 584.2) | 1 | 1 Marker |
| R | 0.75 - 2.25 (19.1 - 57.2) | 8.00 x 8.00 (203.2 x 203.2) | 1 | |

* For Styles A, B and C, order number of cards required in multiples of Std. Pkg. Qty.; for Styles M and R, order number of markers required in multiples of Std. Pkg. Qty.

| Part Numbers | | | | | Legend | Color (Legend/ Background) |
|--------------|----------|----------|----------|----------|-------------------------|----------------------------|
| Style A | Style B | Style C | Style M | Style R | | |
| PCV-FOA† | PCV-FOB† | PCV-FOC† | PCV-FOM | PCV-FOR | Fiber Optic | Black/Orange |
| PCV-FOCA | PCV-FOCB | PCV-FOCC | PCV-FOCM | PCV-FOCR | Fiber Optic Cable | |
| PCV-FOSA | PCV-FOSB | PCV-FOSC | — | — | ⚡— (Fiber Optic Symbol) | |
| | | | | | | |

†Also available in Spanish and Portuguese. To order, add part number suffix -E for Spanish or -P for Portuguese

Underground Hazard Tape



- Used to warn of buried cable lines
- Non-adhesive tape will not biodegrade
- Available in detectable aluminum foil laminate and polyethylene materials

| Legend | Background Color | Detectable Tape Part Number | | | Polyethylene Tape Part Number | | Std. Pkg. Qty.* |
|---|------------------|-------------------------------|-------------------------------|--------------------------------|-------------------------------|--------------------------------|-----------------|
| | | 2" x 1000 ft. (51 mm x 305 m) | 3" x 1000 ft. (76 mm x 305 m) | 6" x 1000 ft. (152 mm x 305 m) | 3" x 2000 ft. (76 mm x 610 m) | 6" x 1000 ft. (152 mm x 305 m) | |
| CAUTION CAUTION CAUTION CABLE T.V. LINE BURIED BELOW | Orange | HTDU20-TV | HTDU30-TV | HTDU60-TV | — | HTU60-TV† | 1 Roll |
| | Green | — | — | — | HTU3G-TV† | HTU6G-TV† | |
| CAUTION CAUTION CAUTION ELECTRIC LINE BURIED BELOW | Red | HTDU2R-E | HTDU3R-E | HTDU6R-E | HTU3R-E† | HTU6R-E† | |
| | Yellow | — | — | — | HTU3Y-E† | HTU6Y-E† | |
| CAUTION CAUTION CAUTION TELEPHONE LINE BURIED BELOW | Orange | HTDU20-T | HTDU30-T | HTDU60-T | HTU30-T† | HTU60-T | |
| | Green | — | — | — | HTU3G-T† | HTU6G-T† | |
| CAUTION CAUTION CAUTION BURIED FIBER OPTIC CABLE | Orange | HTDU20-FO | HTDU30-FO | HTDU60-FO | HTU30-FO† | HTU60-FO† | |
| | | | | | | | |

†Also available in Spanish and Portuguese. To order, add part number suffix -E for Spanish or -P for Portuguese
*Order number of rolls required in multiples of Std. Pkg. Qty.

Voltage and Fiber Optic Markers

Available in two styles:



Adhesive Marker Cards

- Durable GMV1 Indoor Vinyl Material
- Available in 3 sizes



Snap-On Markers (Non-Adhesive)

- Pre-coiled, sub-surface printed markers for indoor use
- Available in 2 sizes

| Style | Type | Pipe / Conduit O.D. In. (mm) | Marker Size Width x Length In. (mm) | Markers Per Card | Std. Pkg. Qty.* |
|-------|--------------------------------|------------------------------|-------------------------------------|------------------|-----------------|
| A | Adhesive Marker Cards | 3.00 (76.2) and Over | 9.00 x 2.25 (228.6 x 57.1) | 1 | 5 Cards |
| B | | 1.25 - 3.00 (31.7 - 76.2) | 4.50 x 1.13 (114.3 x 28.6) | 4 | |
| C | | 1.25 (31.7) and Under | 2.25 x 0.50 (57.1 x 12.7) | 18 | |
| M | Snap-On Markers (Non-Adhesive) | 2.25 - 6.00 (57.2 - 152.4) | 14.00 x 23.00 (355.6 x 584.2) | 1 | 1 Marker |
| R | | 0.75 - 2.25 (19.1 x 57.2) | 8.00 x 8.00 (203.2 x 203.2) | 1 | |

*For Styles A, B, and C, order number of cards required in multiples of Std. Pkg. Qty; for Styles M and R, order number of markers required in multiples of Std. Pkg. Qty.

| Part Number† | | | | | Legend | Color (Legend/Bkrd) |
|--------------|------------|------------|-----------|----------|-------------|---------------------|
| Style A | Style B | Style C | Style M | Style R | | |
| PCV-VOLTSA | PCV-VOLTSB | PCV-VOLTSC | — | — | — VOLTS | Black/Orange |
| PCV-110A | PCV-110B | PCV-110C | — | — | 110 Volts | |
| PCV-115A | PCV-115B | PCV-115C | — | — | 115 Volts | |
| PCV-120A | PCV-120B | PCV-120C | PCV-120M | PCV-120R | 120 Volts | |
| PCV-208A | PCV-208B | PCV-208C | PCV-208M | PCV-208R | 208 Volts | |
| PCV-220A | PCV-220B | PCV-220C | — | — | 220 Volts | |
| PCV-230A | PCV-230B | PCV-230C | — | — | 230 Volts | |
| PCV-240A | PCV-240B | PCV-240C | — | — | 240 Volts | |
| PCV-250A | PCV-250B | PCV-250C | — | — | 250 Volts | |
| PCV-277A | PCV-277B | PCV-277C | — | — | 277 Volts | |
| PCV-380A | PCV-380B | PCV-380C | — | — | 380 Volts | |
| PCV-415A | PCV-415B | PCV-415C | — | — | 415 Volts | |
| PCV-440A | PCV-440B | PCV-440C | — | — | 440 Volts | |
| PCV-460A | PCV-460B | PCV-460C | — | — | 460 Volts | |
| PCV-480A | PCV-480B | PCV-480C | PCV-480M | PCV-480R | 480 Volts | |
| PCV-550A | PCV-550B | PCV-550C | — | — | 550 Volts | |
| PCV-600A | PCV-600B | PCV-600C | PCV-600M | PCV-600R | 600 Volts | |
| PCV-2200A | PCV-2200B | — | — | — | 2200 Volts | |
| PCV-2300A | PCV-2300B | PCV-2300C | — | — | 2300 Volts | |
| PCV-2400A | PCV-2400B | PCV-2400C | — | — | 2400 Volts | |
| PCV-4160A | PCV-4160B | PCV-4160C | PCV-4160M | — | 4160 Volts | |
| PCV-4800A | PCV-4800B | — | — | — | 4800 Volts | |
| PCV-5000A | PCV-5000B | — | — | — | 5000 Volts | |
| PCV-6900A | PCV-6900B | — | — | — | 6900 Volts | |
| PCV-7200A | PCV-7200B | — | — | — | 7200 Volts | |
| PCV-12000A | PCV-12000B | PCV-12000C | — | — | 12000 Volts | |
| PCV-12470A | PCV-12470B | PCV-12470C | — | — | 12470 Volts | |
| PCV-13000A | PCV-13000B | — | — | — | 13000 Volts | |
| PCV-13200A | PCV-13200B | PCV-13200C | — | — | 13200 Volts | |
| PCV-13800A | PCV-13800B | PCV-13800C | — | — | 13800 Volts | |

†Most legends also available in Spanish and Portuguese. To order, add part number suffix -E for Spanish or -P for Portuguese

More legends shown on the following page.

Voltage and Fiber Optic Markers (cont.)

| Part Number† | | | | | Legend | Color (Legend/Bkrd) |
|--------------|--------------|--------------|--------------|--------------|--|------------------------|
| Style A | Style B | Style C | Style M | Style R | | |
| PCV-120/208A | PCV-120/208B | PCV-120/208C | PCV-120/208M | PCV-120/208R | 120/208 Volts | Black/Orange |
| PCV-240/480A | PCV-240/480B | PCV-240/480C | — | — | 240/480 Volts | Black/Orange |
| PCV-277/480A | PCV-277/480B | PCV-277/480C | — | — | 277/480 Volts | Black/Orange |
| PCV-ACA | PCV-ACB | PCV-ACC | — | — | AC | Black/Orange |
| PCV-DCA | PCV-DCB | PCV-DCC | — | — | DC | Black/Orange |
| PCV-A/CA | PCV-A/CB | PCV-A/CC | — | — | Air Cond. | Black/Orange |
| PCV-BLANKA | PCV-BLANKB | PCV-BLANKC | — | — | Blank-No Legend | Black/Orange |
| PCV-CHTA | PCV-CHTB | PCV-CHTC | PCV-CHTM | PCV-CHTR | Caution-Heat Traced | Black/Orange |
| PCV-CNA | PCV-CNB | PCV-CNC | — | — | Circuit # | Black/Orange |
| PCV-CBA | PCV-CBB | PCV-CBC | — | — | Circuit Breaker | Black/Orange |
| PCV-EOOSA | PCV-EOOSB | PCV-EOOSC | — | — | Electric Out of Service | Black/Orange |
| PCV-ESA | PCV-ESB | PCV-ESC | — | — | Emergency Service | Black/Orange |
| PCV-EXL TSA | PCV-EXL TSB | PCV-EXL TSC | — | — | Exit Lights | Black/Orange |
| PCV-FAA | PCV-FAB | PCV-FAC | — | — | Fire Alarm | Black/Orange |
| PCV-FOA | PCV-FOB | PCV-FOC | PCV-FOM | PCV-FOR | Fiber Optic | Black/Orange |
| PCV-FOCA | PCV-FOCB | PCV-FOCC | PCV-FOCM | PCV-FOCR | Fiber Optic Cable | Black/Orange |
| PCV-FOSA | PCV-FOSB | PCV-FOSC | — | — |  (Fiber Optic Symbol) | Black/Orange |
| PCV-FBOXA | PCV-FBOXB | PCV-FBOXC | — | — | Fuse Box | Black/Orange |
| PCV-HTCRTA | PCV-HTCRTB | PCV-HTCRTC | — | — | Heating Circuit | Black/Orange |
| PCV-INSAA | PCV-INSAB | PCV-INSAC | — | — | Intrinsically Safe | Black/Orange |
| PCV-INTRA | PCV-INTRB | PCV-INTRC | — | — | Intrinsic Safety Wiring | Black/Orange |
| PCV-LTSA | PCV-LTSB | PCV-LTSC | — | — | Lights | Black/Orange |
| PCV-L/PA | PCV-L/PB | PCV-L/PC | — | — | Light & Power | Black/Orange |
| PCV-MAINA | PCV-MAINB | PCV-MAINC | — | — | Main | Black/Orange |
| PCV-OOA | PCV-OOB | PCV-OOC | — | — | On/Off | Black/Orange |
| PCV-PWRA | PCV-PWRB | PCV-PWRC | — | — | Power | Black/Orange |
| PCV-1PHA | PCV-1PHB | PCV-1PHC | — | — | Single Phase | Black/Orange |
| PCV-SPAREA | PCV-SPAREB | PCV-SPAREC | — | — | Spare | Black/Orange |
| PCV-TELEA | PCV-TELEB | PCV-TELEC | — | — | Telephone | Black/Orange |
| PCV-3PHA | PCV-3PHB | PCV-3PHC | — | — | Three Phase | Black/Orange |

†Most legends also available in Spanish and Portuguese. To order, add part number suffix -E for Spanish or -P for Portuguese

Voltage and Ampere Markers



- Durable vinyl cloth markers
- Black legend on yellow background

| Style | Marker Size Width x Length In. (mm) | Markers Per Card |
|-------|---|---------------------|
| A | 8.98 x 2.24 (228.0 x 57.0) | 1 |
| B | 4.49 x 1.02 (114.0 x 26.0) | 4 |
| C | 2.24 x 0.51 (57.0 x 13.0) | 18 |
| D | 1.12 x 0.51 (28.5 x 13.0) | 36 |
| F | 0.75 x 0.35 (19.0 x 9.0) | 48 |

| Part Number | | | | | Legend | Color (Legend/Bkrnd) | Material | Std. Pkg. Qty.* |
|-------------|-------------|-------------|-------------|-------------|----------|-------------------------|------------------------|-----------------------|
| Style A | Style B | Style C | Style D | Style F | | | | |
| PESC-A-5V | PESC-B-5V | PESC-C-5V | PESC-D-5V | — | 5 Volt | Black/Yellow | GMC1 Vinyl Cloth | 5 Cards |
| PESC-A-6V | PESC-B-6V | PESC-C-6V | PESC-D-6V | — | 6 Volt | | | |
| PESC-A-12V | PESC-B-12V | PESC-C-12V | PESC-D-12V | — | 12 Volt | | | |
| PESC-A-24V | PESC-B-24V | PESC-C-24V | PESC-D-24V | — | 24 Volt | | | |
| PESC-A-48V | PESC-B-48V | PESC-C-48V | PESC-D-48V | — | 48 Volt | | | |
| PESC-A-60V | PESC-B-60V | PESC-C-60V | PESC-D-60V | — | 60 Volt | | | |
| PESC-A-110V | PESC-B-110V | PESC-C-110V | PESC-D-110V | — | 110 Volt | | | |
| PESC-A-220V | PESC-B-220V | PESC-C-220V | PESC-D-220V | — | 220 Volt | | | |
| PESC-A-230V | PESC-B-230V | PESC-C-230V | PESC-D-230V | — | 230 Volt | | | |
| PESC-A-240V | PESC-B-240V | PESC-C-240V | PESC-D-240V | — | 240 Volt | | | |
| PESC-A-380V | PESC-B-380V | PESC-C-380V | PESC-D-380V | — | 380 Volt | | | |
| PESC-A-400V | PESC-B-400V | PESC-C-400V | PESC-D-400V | — | 400 Volt | | | |
| PESC-A-440V | PESC-B-440V | PESC-C-440V | PESC-D-440V | — | 440 Volt | | | |
| PESC-A-500V | PESC-B-500V | PESC-C-500V | PESC-D-500V | — | 500 Volt | | | |
| PESC-A-600V | PESC-B-600V | PESC-C-600V | PESC-D-600V | — | 600 Volt | | | |
| — | — | — | — | PESC-F-L1 | L1 | | | |
| — | — | — | — | PESC-F-L2 | L2 | | | |
| — | — | — | — | PESC-F-L3 | L3 | | | |
| — | — | — | — | PESC-F-N | N | | | |
| — | — | — | — | PESC-F-LPLS | L+ | | | |
| — | — | — | — | PESC-F-LMIN | L- | | | |
| — | — | — | — | PESC-F-M | M | | | |
| — | — | — | — | PESC-F-AC | AC | | | |
| — | — | — | — | PESC-F-DC | DC | | | |
| — | — | — | — | PESC-F-ON | On | | | |
| — | — | — | — | PESC-F-OFF | Off | | | |
| — | — | — | — | PESC-F-VOLT | Volt | | | |
| — | — | — | — | PESC-F-2A | 2A | | | |
| — | — | — | — | PESC-F-4A | 4A | | | |
| — | — | — | — | PESC-F-6A | 6A | | | |
| — | — | — | — | PESC-F-10A | 10A | | | |
| — | — | — | — | PESC-F-16A | 16A | | | |
| — | — | — | — | PESC-F-25A | 25A | | | |
| — | — | — | — | PESC-F-35A | 35A | | | |
| — | — | — | — | PESC-F-50A | 50A | | | |
| — | — | — | — | PESC-F-63A | 63A | | | |
| — | — | — | — | PESC-F-75A | 75A | | | |

*Order number of cards required in multiples of Std. Pkg. Qty.

Electrical Symbols

| Part Number | Legend | Description | Marker Size Width x Length In. (mm) | Markers Per Card | Color (Legend/ Background) | Material | Std. Pkg. Qty.* |
|--------------------------|---|--|--|------------------------|----------------------------------|------------------------|-----------------------|
| PESC-H-PE PESC-J-PE |  | Protective Conductor | 0.51 x 0.51 (13.0 x 13.0) 0.75 x 0.75 (19.0 x 19.0) | 60 36 | Black/Yellow | GMC1 Vinyl Cloth | 10 Cards |
| PESC-H-PU PESC-J-PU |  | Protective Conductor No Earth | 0.51 x 0.51 (13.0 x 13.0) 0.75 x 0.75 (19.0 x 19.0) | 60 36 | | | |
| PESC-H-PEN PESC-J-PEN |  | Neutral Conductor with Protective-Function (PEN conductor) | 0.51 x 0.51 (13.0 x 13.0) 0.75 x 0.75 (19.0 x 19.0) | 60 36 | | | |
| PESC-H-N PESC-J-N |  | Neutral Conductor | 0.51 x 0.51 (13.0 x 13.0) 0.75 x 0.75 (19.0 x 19.0) | 60 36 | | | |
| PESC-H-EC PESC-J-EC |  | Safety Function | 0.51 x 0.51 (13.0 x 13.0) 0.75 x 0.75 (19.0 x 19.0) | 60 36 | | | |
| PESC-H-E PESC-J-E |  | Earth (Ground) | 0.51 x 0.51 (13.0 x 13.0) 0.75 x 0.75 (19.0 x 19.0) | 60 36 | | | |
| PESC-H-DT PESC-J-DT |  | Splash Proof Against Splashes from All Directions (per DIN 40050 Part 2) | 0.51 x 0.51 (13.0 x 13.0) 0.75 x 0.75 (19.0 x 19.0) | 60 36 | | | |
| PESC-H-AT PESC-J-AT |  | Warning of Dangerous Electrical Voltage | 0.51 x 0.51 (13.0 x 13.0) 0.75 x 0.75 (19.0 x 19.0) | 60 36 | | | |
| PESC-H-LT PESC-J-LT |  | Warning of Laser Beam | 0.51 x 0.51 (13.0 x 13.0) 0.75 x 0.75 (19.0 x 19.0) | 60 36 | | | |
| PESC-H-HT PESC-J-HT |  | Static Sensitive Device; Handling Precautions Required | 0.51 x 0.51 (13.0 x 13.0) 0.75 x 0.75 (19.0 x 19.0) | 60 36 | | | |
| PESC-H-BT PESC-J-BT |  | Warning of Battery Hazards | 0.51 x 0.51 (13.0 x 13.0) 0.75 x 0.75 (19.0 x 19.0) | 60 36 | | | |
| PESC-H-SI PESC-J-SI |  | Protective Isolation | 0.51 x 0.51 (13.0 x 13.0) 0.75 x 0.75 (19.0 x 19.0) | 60 36 | | | |

*Order number of cards required in multiples of Std. Pkg. Qty.

Warning Labels

- Pre-titled labels used for industrial and electrical applications on product, packages or facilities to warn or inform
- Eliminate hazardous situations and create safe work environments

Choose the legend and style that suits your informational needs:



Individual Labels in Packages and Roll Mounted Labels

- Available in paper and indoor/outdoor vinyl materials
- Choose from a wide variety of stock legends
- Sold by the package or roll



PLD Dispenser Labels

- Packaged in a dispenser for label protection and your convenience
- Made of durable indoor vinyl film
- Choose from a wide variety of stock legends
- Sold by the dispenser

Warning Label Material Selection Guide

| Material Code | Material | Temperature Range | Description | Color | Outdoor | Hazardous Environment | UL Rec. | CSA |
|---------------|---------------------|------------------------------------|---|---------------|----------------|-----------------------|---------|-----|
| — | Litho Paper | -65°F to 200°F (-54°C to 93°C) | Economical paper labels for indoor and temporary marking | White | No | No | No | No |
| GMM | Laminated Polyester | -40°F to 275°F (-40°C to 135°C) | Laminated material protects legend from abrasion and chemicals | White | Yes | Yes | No | No |
| GMP1 | Destructible Paper | -65°F to 200°F (-54°C to 93°C) | Label will destruct upon removal; for permanent and tamper resistant labeling applications | White | No | No | No | No |
| GMV | Vinyl | -0°F to 170°F (-18°C to 77°C) | High quality indoor vinyl film; resists oil, water and solvents | White | No | No | Yes | Yes |
| GMV1 | Vinyl | -40°F to 176°F (-40°C to 80°C) | Long lasting, general purpose vinyl film for indoor and outdoor marking | White | Yes (2 yrs) | No | No | No |
| GMV10L | Laminated Vinyl | -40°F to 225°F (-40°C to 107°C) | Laminated vinyl film for indoor/outdoor use; laminate protects legend from abrasion and chemicals | White, Yellow | Yes | Yes | No | No |
| GMV10 | Destructible Vinyl | -65°F to 200°F (-54°C to 93°C) | Label will destruct upon removal; for permanent and tamper resistant labeling applications | White | Yes | No | No | No |
| GMV | Polyester | -40°F to 311°F (-40°C to 154°C) | Provides durability, high temperature resistance, and dimensional stability | White | Yes | Yes | Yes | Yes |

Static Awareness Labels



WL1



WL3

Rolls

| Part Number | Material | Legend | Color (Legend/Background) | Label Size Width x Length In. (mm) | Labels per Roll | Std. Pkg. Qty.* |
|-------------|-------------|--------------------------|---------------------------|------------------------------------|-----------------|-----------------|
| WL1 | Litho Paper | Static Awareness Warning | Black/Yellow | 2.00 x 2.00 (50.8 x 50.8) | 500 | 1 Roll |
| WL3 | Litho Paper | Static Awareness Warning | Black/Yellow | 2.00 x 2.00 (50.8 x 50.8) | 500 | |

*Order number of rolls required in multiples of Std. Pkg. Qty.



PLD-49



PLD-58
MIL STD. 129J



PLD-33



PLD-60
EIA STD. 471



PLD-59
MIL and EIA

PLD Dispenser

| Part Number | Material | Legend | Color (Legend/Background) | Label Size Width x Length In. (mm) | Labels per Dispenser | Std. Pkg. Qty.* |
|-------------|---------------|------------------------------------|---------------------------|------------------------------------|----------------------|-----------------|
| PLD-49 | GMM Polyester | Anti-Static | Black/Yellow | 1.50 x 1.00 (38.1 x 25.4) | 200 | 1 Disp. |
| PLD-58 | GMM Polyester | Static Awareness (MIL STD 129J) | Black/Yellow | 1.50 x 1.00 (38.1 x 25.4) | 200 | |
| PLD-60 | GMM Polyester | Static Awareness (EIA STD 471) | Black/Yellow | 3.00 x 1.00 (76.2 x 25.4) | 100 | |
| PLD-59 | GMM Polyester | Static Awareness (MIL STD and EIA) | Black/Yellow | 3.00 x 1.00 (76.2 x 25.4) | 100 | |
| PLD-33 | GMM Polyester | Caution Static Eliminators | Black/Yellow | 1.50 x 1.00 (38.1 x 25.4) | 200 | |

*Order number of dispensers required in multiples of Std. Pkg. Qty.

Electrical Labels



WL25



WL32
ISO 3864



WL33
ISO 3864

Individual Labels in Packages

| Part Number | Material | Legend | Color (Legend/Background) | Label Size Width x Length In. (mm) | Labels per Pkg. | Std. Pkg. Qty.* |
|-------------|---------------|---------------------------------------|---------------------------|------------------------------------|-----------------|-----------------|
| WL25 | GMY Polyester | Warning...Lift & Lock | Black/Yellow | 3.50 x 1.50 (88.9 x 38.1) | 50 | 1 Pkg. |
| WL32 | GMV1OL Vinyl | Caution Risk Of Electrical Shock Sym. | Black/Yellow | 1.50 (38.1) Triangle | 50 | |
| WL33 | GMV1OL Vinyl | Caution Risk Of Electrical Shock Sym. | Black/Yellow | 4.50 (114.3) Triangle | 50 | |

*Order number of packages required in multiples of Std. Pkg. Qty.



PLD-52
ISO 3864



PLD-82
NEC 210-4(d)



- PLD-36 Caution 120V
- PLD-44 Caution 208V
- PLD-37 Caution 220V
- PLD-45 Caution 230V
- PLD-38 Caution 240V
- PLD-46 Caution 277V
- PLD-47 Caution 277/480V
- PLD-48 Caution 380V
- PLD-39 Caution 440V
- PLD-40 Caution 460V



PLD-32



PLD-76
NEC 110.22



PLD-12



PLD-43

PLD Dispensers

| Part Number | Material | Legend | Color (Legend/Background) | Label Size Width x Length In. (mm) | Labels per Dispenser | Std. Pkg. Qty.* |
|-------------|---------------|-----------------------------------|---------------------------|------------------------------------|----------------------|-----------------|
| PLD-52 | GMM Polyester | Attention Symbol | Black/Yellow | 1.50 x 1.00 (38.1 x 25.4) | 200 | 1 Disp. |
| PLD-82 | GMM Polyester | Board Identification Circuit I.D. | Black/White | 1.50 x 1.00 (38.1 x 25.4) | 200 | |
| PLD-36 | GMM Polyester | Caution 120V | Black/Yellow | 1.50 x 1.00 (38.1 x 25.4) | 200 | |
| PLD-44 | GMM Polyester | Caution 208V | Black/Yellow | 1.50 x 1.00 (38.1 x 25.4) | 200 | |
| PLD-37 | GMM Polyester | Caution 220V | Black/Yellow | 1.50 x 1.00 (38.1 x 25.4) | 200 | |
| PLD-45 | GMM Polyester | Caution 230V | Black/Yellow | 1.50 x 1.00 (38.1 x 25.4) | 200 | |
| PLD-38 | GMM Polyester | Caution 240V | Black/Yellow | 1.50 x 1.00 (38.1 x 25.4) | 200 | |
| PLD-46 | GMM Polyester | Caution 277V | Black/Yellow | 1.50 x 1.00 (38.1 x 25.4) | 200 | |
| PLD-47 | GMM Polyester | Caution 277/480V | Black/Yellow | 1.50 x 1.00 (38.1 x 25.4) | 200 | |
| PLD-48 | GMM Polyester | Caution 380V | Black/Yellow | 1.50 x 1.00 (38.1 x 25.4) | 200 | |
| PLD-39 | GMM Polyester | Caution 440V | Black/Yellow | 1.50 x 1.00 (38.1 x 25.4) | 200 | |
| PLD-40 | GMM Polyester | Caution 460V | Black/Yellow | 1.50 x 1.00 (38.1 x 25.4) | 200 | |
| PLD-32 | GMM Polyester | Caution R.F. Voltage | Black/Yellow | 1.50 x 1.00 (38.1 x 25.4) | 200 | |
| PLD-76 | GMM Polyester | Caution Series Rated System | Black/Yellow | 1.50 x 1.00 (38.1 x 25.4) | 200 | |
| PLD-12 | GMM Polyester | Circuit No. | Orange/White | 1.50 x 1.00 (38.1 x 25.4) | 200 | |
| PLD-43 | GMM Polyester | Danger High Voltage | Red & Black/White | 1.50 x 1.00 (38.1 x 25.4) | 200 | |

*Order number of dispensers required in multiples of Std. Pkg. Qty.

Electrical Labels (cont.)



PLD-67
NEC 110-31



PLD-75
NEC 800



PLD-74



PLD-73
NEC 700.9A



PLD-79
NEC 760.4



PLD-70
NEC 210.8



PLD-57
ISO 3864



PLD-56
ISO 3864



PLD-80
NEC 504.80(b)



PLD-71
NEC 240.53



PLD-81
NEC 230.70(b)



PLD-69
NEC 210



PLD-54



PLD-53

PLD Dispensers (cont.)

| Part Number | Material | Legend | Color (Legend/Background) | Label Size Width x Length In. (mm) | Labels per Dispenser | Std. Pkg. Qty.* | |
|----------------|---------------|--|---------------------------|------------------------------------|----------------------|-----------------|---------|
| PLD-67 | GMM Polyester | Danger High Voltage | Red/White | 1.00 x 1.50 (25.4 x 38.1) | 200 | 1 Disp. | |
| PLD-75 | GMM Polyester | Electrical Hazard | Red/White | 1.50 x 1.00 (38.1 x 25.4) | 200 | | |
| PLD-74 | GMM Polyester | Electrical Shock Caution | Black/Yellow | 1.50 x 1.00 (38.1 x 25.4) | 200 | | |
| PLD-73 | GMM Polyester | Emergency Systems | Red/White | 1.50 x 1.00 (38.1 x 25.4) | 200 | | |
| PLD-79 | GMM Polyester | Fire Protective Signaling | Red/White | 1.50 x 1.00 (38.1 x 25.4) | 200 | | |
| PLD-70 | GMM Polyester | Ground Fault Protected | Black/Clear | 1.00 x 0.38 (25.4 x 9.5) | 800 | | |
| PLD-57 | GMM Polyester | N.E.C. Ground Symbol | Green/White | 0.75 (19.1) Diameter | 300 | | |
| PLD-56 | GMM Polyester | International High Voltage Symbol | Black/Yellow | 1.50 x 1.00 (38.1 x 25.4) | 200 | | |
| PLD-80 | GMM Polyester | Intrinsically Safe Wiring | Light Blue/White | 1.50 x 1.00 (38.1 x 25.4) | 200 | | |
| PLD-71 | GMM Polyester | Warning For Continued Protection...Use Same Fuse | White/Black | 2.00 x 1.00 (50.8 x 25.4) | 150 | | |
| PLD-81 | GMM Polyester | Service Disconnect | Black/White | 1.50 x 1.00 (38.1 x 25.4) | 200 | | |
| PLD-69 | GMM Polyester | This Outlet Controlled By Wall Switch | Black/Clear | 1.00 x 0.38 (25.4 x 9.5) | 800 | | |
| FRENCH | | | | | | | |
| PLD-54 | GMM Polyester | Danger Haute Tension | Red & Black/White | 1.50 x 1.00 (38.1 x 25.4) | 200 | | 1 Disp. |
| SPANISH | | | | | | | |
| PLD-53 | GMM Polyester | Peligro Alto Voltaje | Red & Black/White | 1.50 x 1.00 (38.1 x 25.4) | 200 | 1 Disp. | |

*Order number of dispensers required in multiples of Std. Pkg. Qty.

Hot Surface Warning Labels



WL35



WL36

Individual Labels in Packages

| Part Number | Material | Legend | Color (Legend/Background) | Label Size Width x Length In. (mm) | Labels per Pkg | Std. Pkg. Qty.* |
|-------------|--------------|------------------------------------|---------------------------|------------------------------------|----------------|-----------------|
| WL35 | GMV1OL Vinyl | Caution Hot Surface Warning Symbol | Black/Yellow | 2.00 (50.8) Triangle | 50 | 1 Pkg |
| WL36 | GMV1OL Vinyl | Warning Hot Surface Warning Symbol | Black/Yellow | 2.00 (50.8) Triangle | 50 | 1 Pkg |

*Order number of packages required in multiples of Std. Pkg. Qty.

Packaging / Shipping Labels



PLD-83



PLD-84



PLD-85



PLD-86

PLD Dispensers

| Part Number | Material | Legend | Color (Legend/Background) | Label Size Width x Length In. (mm) | Labels per Dispenser | Std. Pkg. Qty.* |
|-------------|---------------|---------------------------------------|---------------------------|------------------------------------|----------------------|-----------------|
| PLD-83 | GMM Polyester | Product Contains Natural Rubber | Black/Yellow | 2.00 x 1.00 (50.8 x 25.4) | 150 | 1 Disp. |
| PLD-84 | GMM Polyester | Product Contains Dry Natural Rubber | Black/Yellow | 2.00 x 1.00 (50.8 x 25.4) | 150 | |
| PLD-85 | GMM Polyester | Packaging Contains Natural Rubber | Black/Yellow | 2.00 x 1.00 (50.8 x 25.4) | 150 | |
| PLD-86 | GMM Polyester | Packaging Contains Dry Natural Rubber | Black/Yellow | 2.00 x 1.00 (50.8 x 25.4) | 150 | |

*Order number of dispensers required in multiples of Std. Pkg. Qty.

ISO Labels — Warning Symbols

- The International Organization for Standardization (ISO) has established a system to communicate safety information without the use of words. This is accepted in most countries worldwide. Colors and shapes recognizable worldwide are prescribed.
ISO symbology for "Caution" or "Risk of Danger" is a triangle (using black and yellow as its primary colors) to denote "WARNING." The 11 symbols below are those generally accepted as usable without supplementary signs to explain the essence of the message.
- Ref. ISO 3864 (DIN 40008, DIN 4844)

| Part Number | Legend | Description | Triangular Length In. (mm) | Markers Per Card | Material | Std. Pkg. Qty.* |
|---|--------|---|---|--------------------------|------------------------------|--------------------|
| PESW-A-1 PESW-B-1 PESW-C-1 PESW-D-1 PESW-E-1 | | Warning of dangerous electrical voltage | 0.49 (12.5) 0.98 (25.0) 1.97 (50.0) 3.94 (100.0) 7.87 (200.0) | 10 10 10 3 1 | GMV10L Laminated Vinyl | 10 Cards |
| PESW-A-2 PESW-B-2 PESW-C-2 PESW-D-2 PESW-E-2 | | Warning of flammable materials | 0.49 (12.5) 0.98 (25.0) 1.97 (50.0) 3.94 (100.0) 7.87 (200.0) | 10 10 10 3 1 | | |
| PESW-A-3 PESW-B-3 PESW-C-3 PESW-D-3 PESW-E-3 | | Warning of explosive materials | 0.49 (12.5) 0.98 (25.0) 1.97 (50.0) 3.94 (100.0) 7.87 (200.0) | 10 10 10 3 1 | | |
| PESW-A-4 PESW-B-4 PESW-C-4 PESW-D-4 PESW-E-4 | | Warning of toxic materials | 0.49 (12.5) 0.98 (25.0) 1.97 (50.0) 3.94 (100.0) 7.87 (200.0) | 10 10 10 3 1 | | |
| PESW-A-5 PESW-B-5 PESW-C-5 PESW-D-5 PESW-E-5 | | Warning of acids | 0.49 (12.5) 0.98 (25.0) 1.97 (50.0) 3.94 (100.0) 7.87 (200.0) | 10 10 10 3 1 | | |
| PESW-A-6 PESW-B-6 PESW-C-6 PESW-D-6 PESW-E-6 | | Warning of radio-active materials or ionizing rays | 0.49 (12.5) 0.98 (25.0) 1.97 (50.0) 3.94 (100.0) 7.87 (200.0) | 10 10 10 3 1 | | |
| PESW-A-7 PESW-B-7 PESW-C-7 PESW-D-7 PESW-E-7 | | Warning of battery hazards | 0.49 (12.5) 0.98 (25.0) 1.97 (50.0) 3.94 (100.0) 7.87 (200.0) | 10 10 10 3 1 | | |
| PESW-A-8 PESW-B-8 PESW-C-8 PESW-D-8 PESW-E-8 | | Warning of laser-beam | 0.49 (12.5) 0.98 (25.0) 1.97 (50.0) 3.94 (100.0) 7.87 (200.0) | 10 10 10 3 1 | | |
| PESW-A-9 PESW-B-9 PESW-C-9 PESW-D-9 PESW-E-9 | | Warning of hazardous area | 0.49 (12.5) 0.98 (25.0) 1.97 (50.0) 3.94 (100.0) 7.87 (200.0) | 10 10 10 3 1 | | |
| PESW-A-10 PESW-B-10 PESW-C-10 PESW-D-10 PESW-E-10 | | Warning of explosive atmosphere | 0.49 (12.5) 0.98 (25.0) 1.97 (50.0) 3.94 (100.0) 7.87 (200.0) | 10 10 10 3 1 | | |
| PESW-A-11 PESW-B-11 PESW-C-11 PESW-D-11 PESW-E-11 | | Warning of static sensitive device | 0.49 (12.5) 0.98 (25.0) 1.97 (50.0) 3.94 (100.0) 7.87 (200.0) | 10 10 10 3 1 | | |

*Order number of cards required in multiples of Std. Pkg. Qty.

ISO Labels — Prohibition Signs

- The circle denotes a prohibition or mandatory action. The following symbols in red, white and black prohibit certain behavior.
- Ref. ISO 3864 (DIN 40008, DIN 4844)

| Part Number | Symbol | Description | Marker Diameter In. (mm) | Markers Per Card | Material | Std. Pkg. Qty.* |
|----------------------------------|---|-------------------------|---|------------------|------------------------------|-----------------|
| PESV-C-1 PESV-D-1 PESV-E-1 |  | Do not throw switch | 1.97 (50.0) 3.94 (100.0) 7.87 (200.0) | 5 1 1 | GMV10L Laminated Vinyl | 10 Cards |
| PESV-C-2 PESV-D-2 PESV-E-2 |  | Do not touch | 1.97 (50.0) 3.94 (100.0) 7.87 (200.0) | 5 1 1 | | |
| PESV-C-3 PESV-D-3 PESV-E-3 |  | No smoking | 1.97 (50.0) 3.94 (100.0) 7.87 (200.0) | 5 1 1 | | |
| PESV-C-4 PESV-D-4 PESV-E-4 |  | No fires or open flames | 1.97 (50.0) 3.94 (100.0) 7.87 (200.0) | 5 1 1 | | |
| PESV-C-5 PESV-D-5 PESV-E-5 |  | Pedestrians prohibited | 1.97 (50.0) 3.94 (100.0) 7.87 (200.0) | 5 1 1 | | |
| PESV-C-6 PESV-D-6 PESV-E-6 |  | No admittance | 1.97 (50.0) 3.94 (100.0) 7.87 (200.0) | 5 1 1 | | |

*Order number of cards required in multiples of Std. Pkg. Qty.

ISO Labels — Mandatory Labels

- The below symbol denotes a mandatory action without the use of words. The most common mandatory action in the Electrical Industry is to insure the electrical supply is switched off.
- Ref. ISO3864 (DIN 40008 and Further Developments)

| Part Number | Symbol | Description | Marker Diameter In. (mm) | Markers Per Card | Material | Std. Pkg. Qty.* |
|--|---|--|---|--------------------|------------------------------|-----------------|
| PESG-A-1 PESG-B-1 PESG-C-1 PESG-D-1 |  | Switch off electrical supply before working on equipment | 0.49 (12.5) 0.98 (25.0) 1.97 (50.0) 3.94 (100.0) | 10 10 5 1 | GMV10L Laminated Vinyl | 10 Cards |

*Order number of cards required in multiples of Std. Pkg. Qty.

Quality / Inspection / Production Control Labels and Tags



Calibration Labels

- Easy write-on surface
- Available in card, book and roll format
- Self-laminating markers available to provide legend protection



Quality Assurance Labels and Tags

- Easy write-on surface
- Available in card and dispenser format
- Wide variety of legends and sizes
- Fluorescent material available for high visibility



Inspection Labels and Tags

- Offered in a variety of legends for recording inspections, services of eye wash stations, fire extinguishers and machinery
- Dated inspection plates and DIN 40010 symbol signs available
- Inspection arrows and marker dots in a variety of colors



Production Control Tags

- For organizing inventory, quality control, OEM and maintenance applications
- Economical card stock tags for indoor or temporary use
- Also available in fluorescent card stock material for high visibility

Material Selection Guide

| Material Code | Material Type | Temperature Range | Key Features | Color | Outdoor Rated | Hazardous Environment | UL Rec | CSA |
|---------------|---------------------|------------------------------------|--|-----------------|------------------|-----------------------|--------|-----|
| GMC1 | Vinyl Cloth | -40°F to 180°F (-40°C to 82°C) | General purpose wire marker material; resists oil and abrasion; can be removed and reused | White Yellow | No | No | No | No |
| GMP1 | Destructible Paper | -65°F to 200°F (-54°C to 93°C) | Litho paper with destructible adhesive for permanent applications | White | No | No | No | No |
| GMM | Laminated Polyester | -40°F to 275°F (-40°C to 135°C) | Laminated material protects legend from abrasion and chemicals | White | Yes | Yes | No | No |
| GMV | Vinyl Film | 0°F to 170°F (-18°C to 77°C) | Indoor vinyl film with write-on surface | White Yellow | No | No | Yes | Yes |
| GMV1 | Vinyl Film | -40°F to 176°F (-40°C to 80°C) | General purpose indoor/outdoor vinyl film | White | Yes (2 years) | No | No | No |
| GMV5 | Semi-Rigid Vinyl | -40°F to 150°F (-40°C to 66°C) | Non-adhesive vinyl tag stock with easy write-on surface | White Yellow | Yes (2 years) | No | No | No |
| GMV10 | Destructible Vinyl | -65°F to 200°F (-54°C to 93°C) | Vinyl film with destructible adhesive for permanent application; breaks into pieces upon removal | White | Yes | No | No | No |
| GMV | Polyester | -40°F to 311°F (-40°C to 154°C) | Provides durability, high temperature resistance, and dimensional stability | White | Yes | Yes | Yes | Yes |



Calibration Labels



- Mounted on cards for easy application and control of unused labels
- Easy write-on surface
- Durable indoor vinyl material resists oil and solvents and has permanent acrylic adhesive
- Ideal for small tools, gauges, etc.

| Part Number | Material | Marker Size Width x Length In. (mm) | Markers Per Card | Std. Pkg. Qty.* |
|-------------|------------|-------------------------------------|------------------|-----------------|
| QL-* | GMV1 Vinyl | 2.00 x 0.50 (50.8 x 12.7) | 18 | 25 Cards |

*Order number of cards required in multiples of Std. Pkg. Qty.

| |
|-----------------------------------|
| ACCEPTED / ACEPTADO |
| BY / POR _____ DATE / FECHA _____ |

QL-17

| |
|----------------------------------|
| CALIBRATE BEFORE EACH USE |
|----------------------------------|

QL-8

| |
|------------------------|
| CALIBRATE DAILY |
|------------------------|

QL-6

| |
|--------------------------|
| CALIBRATE MONTHLY |
|--------------------------|

QL-3

| |
|-------------------------|
| CALIBRATE WEEKLY |
|-------------------------|

QL-9

| |
|-----------------------------------|
| CALIBRATION / CALIBRACION |
| BY/POR _____ DATE/FECHA _____ |
| DUE/VENUE _____ ID#/NO. ID. _____ |

QL-19RED†

| |
|---------------------------------|
| CALIBRATION NOT REQUIRED |
|---------------------------------|

QL-4

| |
|--|
| CALIBRATION NOT REQUIRED NO REQUIRE CALIBRACION |
|--|

QL-18

| |
|---------------------------------|
| DEFECTIVE DO NOT USE |
|---------------------------------|

QL-13

| |
|-----------------------------------|
| DO NOT REMOVE FROM QC AREA |
|-----------------------------------|

QL-11

| |
|---------------------|
| INACTIVE |
| BY _____ DATE _____ |

QL-16

| | |
|------------------|------|
| INVENTORY | |
| NO | DATE |
| COUNT | BY |

QL-2

| |
|----------------------------------|
| NOT IN CALIBRATION SYSTEM |
|----------------------------------|

QL-7

| |
|--|
| OUT OF CALIBRATION DO NOT USE |
|--|

QL-10

| |
|---|
| OUT OF CALIBRATION DO NOT USE SIN CALIBRAR NO USAR |
|---|

QL-20

| |
|-------------------------------|
| PREVENTIVE MAINTENANCE |
| BY _____ DATE _____ |
| NEXT MAINT. DATE _____ |

QL-15RED†

| |
|------------------------------------|
| STANDARDIZE BEFORE EACH USE |
|------------------------------------|

QL-5

| | |
|-----------------|--------------|
| TOOL NO. | |
| | DEPT. |

QL-12RED†

| |
|-----------------------|
| VERIFICATION |
| BY _____ DATE _____ |
| DUE _____ I.D.# _____ |

QL-14RED†

†Other background colors available. To order, replace "RED" with "YEL" for yellow, "ORNG" for orange, "GRN" for green, "LTBLU" for light blue and "LTGRN" for light green.

Self-Laminating Calibration Labels



- Work well on small instruments
- Durable indoor vinyl material, with clear overlaminate provides easy write-on surface and protects the legend
- Permanent acrylic adhesive
- Choose from a variety of colors for multiple department or personnel identification

Marker Cards

| Part Number | Legend | Write-On Area Color (Legend/Background) | Write-On Area Size W X L In. (mm) | Total Marker Size W X L In. (mm) | Markers Per Card | Material | Std. Pkg. Qty.* | | | | |
|-------------|--|---|---|----------------------------------|------------------|-------------|-----------------------------|------------------------------|----|---------------------|----------|
| QL-21WHT | <table border="1"> <tr> <td>C</td> <td rowspan="7">ID# _____ BY _____ DATE _____ DUE _____</td> </tr> <tr> <td>A</td> </tr> <tr> <td>L</td> </tr> </table> | C | ID# _____ BY _____ DATE _____ DUE _____ | A | L | Black/White | 2.25 x 0.38 (57.1 x 9.5) | 5.25 x 0.38 (133.4 x 9.5) | 25 | GMV3 Self-Lam Vinyl | 10 Cards |
| C | | ID# _____ BY _____ DATE _____ DUE _____ | | | | | | | | | |
| A | | | | | | | | | | | |
| L | | | | | | | | | | | |
| QL-21YEL | | | | Black/Yellow | | | | | | | |
| QL-21RED | | | | Black/Red | | | | | | | |
| QL-21ORNG | | | | Black/Orange | | | | | | | |
| QL-21GRN | Black/Green | | | | | | | | | | |
| QL-21LTBLU | Black/Light Blue | | | | | | | | | | |
| QL-21LTGRN | Black/Light Green | | | | | | | | | | |

*Order number of cards required in multiples of Std. Pkg. Qty.

Marker Books

| Part Number | Legend | Write-On Area Color (Legend/Background) | Write-On Area Size W X L In. (mm) | Total Marker Size W X L In. (mm) | Markers Per Page | Pages Per Book | Material | Std. Pkg. Qty.* | | | | | |
|-------------------|--|---|-----------------------------------|----------------------------------|------------------|----------------|-------------|------------------------------|------------------------------|---|----|---------------------|--------|
| PSCB-3CAL | <table border="1"> <tr> <td>CALIBRATED</td> </tr> <tr> <td>NO: _____</td> </tr> <tr> <td>BY: _____</td> </tr> <tr> <td>DATE: _____</td> </tr> <tr> <td>DUE: _____</td> </tr> </table> | CALIBRATED | NO: _____ | BY: _____ | DATE: _____ | DUE: _____ | Green/White | 1.00 x 0.75 (25.4 x 19.1) | 1.00 x 3.00 (25.4 x 76.2) | 6 | 10 | GMV3 Self-Lam Vinyl | 1 Book |
| CALIBRATED | | | | | | | | | | | | | |
| NO: _____ | | | | | | | | | | | | | |
| BY: _____ | | | | | | | | | | | | | |
| DATE: _____ | | | | | | | | | | | | | |
| DUE: _____ | | | | | | | | | | | | | |
| PSCB-6CAL | Green/White | 1.00 x 1.00 (25.4 x 25.4) | 1.00 x 6.00 (25.4 x 152.4) | 3 | | | | | | | | | |

*Order number of books required in multiples of Std. Pkg. Qty.

Calibration Dots



- Ideal for small instruments used in hard to reach areas
- Durable indoor vinyl material provides easy write-on surface
- Permanent acrylic adhesive
- Used for quality control

| Part Number | Legend | Color (Legend/Background) | Marker Diameter In. (mm) | Labels Per Roll | Material | Std. Pkg. Qty.* |
|-------------|--------|---------------------------|--------------------------|-----------------|------------|-----------------|
| QL-1WHT | | Black/White | 0.75 (19.1) | 500 | GMV1 Vinyl | 1 Roll |
| QL-1YEL | | Black/Yellow | | | | |
| QL-1RED | | Black/Red | | | | |
| QL-1ORNG | | Black/Orange | | | | |
| QL-1GRN | | Black/Green | | | | |
| QL-1LTBLU | | Black/Light Blue | | | | |
| QL-1LTGRN | | Black/Light Green | | | | |

*Order number of rolls required in multiples of Std. Pkg. Qty.

Write-On Labels on Cards



- For quality control, OEM, maintenance and field service applications
- Available in two sizes
- Mark with ball point pen or Panduit Marking Pens (see [pg. 137](#))

| Part Number | Material | Marker Size Width x Length In. (mm) | Markers Per Card | Std. Pkg. Qty.* |
|-------------|------------------|-------------------------------------|------------------|-----------------|
| PCWL-* | GMC1 Vinyl Cloth | 1.50 x 0.63 (38.1 x 15.9) | 14 | 25 Cards |
| PCWLL-* | GMC1 Vinyl Cloth | 2.25 x 1.00 (57.2 x 25.4) | 9 | 25 Cards |

*Order number of cards required in multiples of Std. Pkg. Qty.

| ACCEPTED | |
|----------|------------|
| BY _____ | DATE _____ |

PCWL-ACC
PCWLL-ACC

| BATCH NO. | DATE |
|-----------|-------|
| _____ | _____ |

PCWL-BN

| CALIBRATED | |
|------------|------------|
| BY _____ | DATE _____ |
| DUE _____ | |

PCWL-CALD
PCWLL-CALD

| CALIBRATION | |
|-------------|------------|
| BY _____ | DATE _____ |
| DUE _____ | |

PCWL-CAL
PCWLL-CAL

| CALIBRATION | |
|-----------------|------------|
| GUAGE NO. _____ | |
| ACCURACY _____ | |
| BY _____ | DATE _____ |
| DUE _____ | |

PCWL-VCAL

| CALIBRATION | |
|---------------|------------|
| BY _____ | DATE _____ |
| DUE _____ | |
| GAGE ID _____ | |

PCWL-ICAL

| CALIBRATION | |
|-------------|------------|
| BY _____ | DATE _____ |
| DUE _____ | |
| ID# _____ | |

PCWL-CALN
PCWLL-CALN

| CAUTION | |
|---------|--|
|---------|--|

PCWL-CAU

| CERTIFICATION | |
|---------------|------------|
| BY _____ | DATE _____ |
| DUE _____ | |

PCWL-CER
PCWLL-CER

| DATE INSTALLED | |
|----------------|--|
| BY _____ | |

PCWL-DI

| DO NOT USE | |
|-------------|--|
| AFTER _____ | |

PCWL-DNU
PCWLL-DNU

| DUE FOR INSPECTION | |
|--------------------|--|
| _____ | |
| DO NOT REMOVE | |

PCWL-DFI

| HOLD | |
|-------------|--|
| FOR _____ | |
| UNTIL _____ | |

PCWL-HLD

| HOLD FOR INSPECTION | |
|---------------------|------------|
| BY _____ | DATE _____ |
| REASON: _____ | |

PCWL-HFI

| INSPECTED | |
|------------|----------------|
| DATE _____ | INITIALS _____ |

PCWL-INS
PCWLL-INS

| MAINTENANCE | |
|-------------|--|
| BY _____ | |
| DATE _____ | |

PCWL-MAIN
PCWLL-MAIN

| QA APPROVED | |
|-------------|--|
| BY _____ | |
| DATE _____ | |

PCWL-QA
PCWLL-QA

| REJECTED | | DATE |
|--------------|----------|-------|
| REASON _____ | | _____ |
| | BY _____ | |

PCWL-REJ
PCWLL-REJ

| RETURN TO VENDOR | |
|------------------|------------|
| BY _____ | DATE _____ |
| REASON: _____ | |

PCWL-RTV

| RE-WORK | | DATE |
|---------------|--|-------|
| BY: _____ | | _____ |
| REASON: _____ | | |

PCWL-RW

| |
|--|
| |
|--|

| Part Number | Color |
|-------------|--------|
| PCWLL-BL | White |
| PCWLL-BLB | Blue |
| PCWLL-BLG | Green |
| PCWLL-BLO | Orange |
| PCWLL-BLR | Red |
| PCWLL-BLY | Yellow |

| CALIBRATION | |
|----------------|------------|
| BY _____ | DATE _____ |
| DUE JAN. _____ | |

| Part Number | Month | Color |
|--------------|-------|-------------|
| PCWL-CAL-JAN | JAN | Orange |
| PCWL-CAL-FEB | FEB | Black |
| PCWL-CAL-MAR | MAR | Light Blue |
| PCWL-CAL-APR | APR | Pink |
| PCWL-CAL-MAY | MAY | Gold |
| PCWL-CAL-JUN | JUN | Yellow |
| PCWL-CAL-JUL | JUL | Light Green |
| PCWL-CAL-AUG | AUG | Red |
| PCWL-CAL-SEP | SEP | Dark Blue |
| PCWL-CAL-OCT | OCT | Tan |
| PCWL-CAL-NOV | NOV | Dark Green |
| PCWL-CAL-DEC | DEC | Gray |

Write-on Quality Labels in Dispenser



- Packaged in a dispenser for label protection and your convenience
- Made of durable laminated polyester film
- Other legends available — Static Awareness (see [page 162](#)) and Electrical (see [page 163](#))

| Part Number | Material | Marker Size Width x Length In. (mm) | Markers Per Dispenser | Std. Pkg. Qty.* |
|-------------|-------------------------|-------------------------------------|-----------------------|-----------------|
| PLD-* | GMM Laminated Polyester | 1.50 x 1.00 (38.1 x 25.4) | 200 | 1 Disp. |

*Order number of dispensers required in multiples of Std. Pkg. qty.

| ACCEPTED | |
|------------|--|
| BY _____ | |
| DATE _____ | |

PLD-4

| CALIBRATION | |
|---------------------|--|
| BY _____ DATE _____ | |
| DUE _____ | |

PLD-22

| CALIBRATION | |
|---------------------|--|
| BY _____ DATE _____ | |
| DUE _____ | |

PLD-3

| CAUTION | |
|---------|--|
| | |

PLD-30

| CAUTION | |
|--------------------|--|
| PINCH POINT | |

PLD-31

| DO NOT USE | |
|-------------|--|
| AFTER _____ | |

PLD-11

| DO NOT USE | |
|---------------------------|--|
| UNTIL TESTED & CALIBRATED | |

PLD-42

| EXPERIMENT | |
|---------------------|--|
| NO. _____ | |
| DATE _____ BY _____ | |

PLD-5

| HOLD FOR INSPECTION | |
|---------------------|--|
| DATE _____ BY _____ | |
| REASON _____ | |

PLD-21

| INVENTORY | |
|-------------|------------|
| NO. _____ | DATE _____ |
| COUNT _____ | BY _____ |

PLD-26

| MAINTENANCE | |
|-------------|--|
| BY _____ | |
| DATE _____ | |

PLD-29

| Q.C. CHECKED | |
|--------------|--|
| BY _____ | |
| DATE _____ | |

PLD-55

| REJECTED | |
|---------------------|--|
| DATE _____ BY _____ | |
| REASON _____ | |

PLD-8

| REPAIRED BY | |
|----------------|--|
| INITIALS _____ | |
| DATE _____ | |

PLD-16

| STOCK NO. | |
|-----------|--|
| | |

PLD-6

| TESTED | |
|------------|--|
| DATE _____ | |
| BY _____ | |

PLD-7

| TOOL NO. | |
|-------------|--|
| DEPT. _____ | |
| | |

PLD-20

| |
|--|
| |
|--|

PLD-17

| |
|--|
| |
|--|

PLD-18



Fluorescent Paper Write-On Quality Labels

- Bright colors draw immediate attention and make sure important information is noticed
- Write-on surface can be marked with pencil, pen, or Panduit Permanent Marker Pens (see [pg. 137](#))

| Part Number | Material | Marker Size Width x Length In. (mm) | Markers Per Sheet | Std. Pkg. Qty.* |
|-------------|------------|-------------------------------------|-------------------|-----------------|
| QLF-* | GMP1 Paper | 2.00 x 1.50 (50.8 x 38.1) | 28 | 500 |

*Order number of markers required in multiples of Std. Pkg. Qty.



QLF-ACC



QLF-BATCH



QLF-BIN

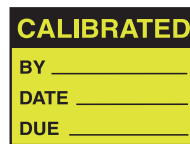

QLF-CALD

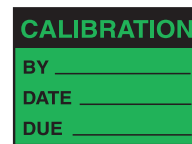

QLF-CALN

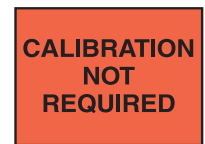

QLF-CNR



QLF-CAU



QLF-CERT

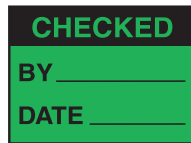

QLF-CHK



QLF-DATE

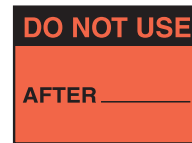

QLF-DNU



QLF-DUE



QLF-HBC



QLF-HOLD



QLF-INS



QLF-INV

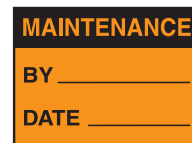

QLF-MAIN



QLF-PACK



QLF-QA



QLF-RE



QLF-REJ

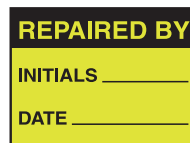

QLF-REP



QLF-SER



QLF-SHELF



QLF-STOCK



QLF-TEST



QLF-BLANK



Quality Control Action Tags



Attach tag to indicate action to be taken

- Unique labels and tags identify the “before and after” of eight common workplace actions
- Ideal for documents, machinery, small parts, bins and more
- Tags feature a perforation so user can tear off the lower portion of the tag once the status has been changed
- Economical card stock tags for indoor or temporary use
- Package consists of 25 tags and 25 Panduit PLT1.5I Cable Ties (5.6" / 142 mm length)

| Part Number | Size W X L In. (mm) | Tags Per Pkg. | Std. Pkg. Qty.* |
|-------------|----------------------------|---------------|-----------------|
| PCT-***-Q | 5.75 x 3.00 (146.1 x 76.2) | 25 | 1 Pkg. |

*Order number of packages required in multiples of Std. Pkg. Qty.



Sign tag and tear at perforation once the status has changed



PCT-211-Q



PCT-205-Q



PCT-208-Q



PCT-204-Q



PCT-207-Q



PCT-206-Q



Inspection Labels and Tags



- Ideal for recording inspections, services of eye wash stations, fire extinguishers and machinery
- Tags are made of economical card stock material for indoor use and are supplied with Panduit PLT1.5I Cable Ties (5.6" / 142 mm length)
- Labels are made of self-adhesive paper for easy application

| Part Number | Type | Material | Size Width x Length In. (mm) | Qty. Per Package | Std. Pkg. Qty.* |
|-------------|-------|--------------------|------------------------------|------------------|-----------------|
| PCT-***-Q | Tag | GMV5 Rigid Plastic | 3.00 x 5.75 (76.2 x 146.05) | 25 | 1 Pkg. |
| PES-**-Q | Label | Paper | 3.00 x 5.00 (76.2 x 127.0) | 25 | 1 Pkg. |

*Order number of packages required in multiples of Std. Pkg. Qty.

EYE WASH STATION INSPECTION
REPLACE WATER / 6 MOS.

| DATE | WATER CHANGED YES / NO | STATION CLEANED YES / NO | INITIALS |
|------|------------------------|--------------------------|----------|
| | | | |
| | | | |
| | | | |
| | | | |
| | | | |
| | | | |
| | | | |
| | | | |
| | | | |
| | | | |

PCT-126-Q
PES-L1-Q

EYEWASH/SHOWER INSPECTION RECORD

Equipment ID _____
Location _____

Test

| Date | Initials | Comments |
|------|----------|----------|
| | | |
| | | |
| | | |
| | | |
| | | |
| | | |
| | | |
| | | |
| | | |
| | | |

PCT-141-Q

FIRE EXTINGUISHER INSPECTION

Last Hydro. Test or Purchase Date _____
Inspection good for 1 year from date shown.

Inspection Record

| Date | Initials |
|------|----------|
| | |
| | |
| | |
| | |
| | |
| | |
| | |
| | |
| | |
| | |

**Consult extinguisher instructions for service recommendations. Contact service company.

PCT-127-Q
PES-L7-Q

FORKLIFT INSPECTION

Date: Tires Lift / Lower System
 Battery Directional/Speed Control

Initials: Steering Emerg. Disconnect
 Controls Hour Meter
 Horn Brakes Options

Comments: _____

Date: Tires Lift / Lower System
 Battery Directional/Speed Control

Initials: Steering Emerg. Disconnect
 Controls Hour Meter
 Horn Brakes Options

Comments: _____

Date: Tires Lift / Lower System
 Battery Directional/Speed Control

Initials: Steering Emerg. Disconnect
 Controls Hour Meter
 Horn Brakes Options

Comments: _____

PCT-144-Q
PES-L5-Q

INSPECTION RECORD

Equipment ID _____
Location _____

| DATE | BY | REMARKS |
|------|----|---------|
| | | |
| | | |
| | | |
| | | |
| | | |
| | | |
| | | |
| | | |
| | | |
| | | |

DO NOT REMOVE TAG

PCT-128-Q
PES-L2-Q

INSPECTION/TEST RECORD

Equipment ID _____
Location _____

Test

| Date | By | Results |
|------|----|---------|
| | | |
| | | |
| | | |
| | | |
| | | |
| | | |
| | | |
| | | |
| | | |
| | | |

PCT-216-Q
PES-L3-Q

SERVICE RECORD

Equipment ID _____
Location _____

| DATE | BY | SERVICE PERFORMED |
|------|----|-------------------|
| | | |
| | | |
| | | |
| | | |
| | | |
| | | |
| | | |
| | | |
| | | |
| | | |

PCT-143-Q
PES-L6-Q

SERVICE RECORD

Equipment ID _____
Location _____

| Last Service Date | By | Next Service Date |
|-------------------|----|-------------------|
| | | |
| | | |
| | | |
| | | |
| | | |
| | | |
| | | |
| | | |
| | | |
| | | |

PCT-217-Q
PES-L4-Q

VALVE INSPECTION

Valve ID _____
Location _____

| DATE | BY | RESULTS |
|------|----|---------|
| | | |
| | | |
| | | |
| | | |
| | | |
| | | |
| | | |
| | | |
| | | |
| | | |

PCT-142-Q



Inspection Plates

- The ideal system for fast recognition of inspection intervals and maintenance dates for safety testing
- Label is destroyed upon removal
- Available for different years and in 7 languages where text is included

| Part Number | Legend | Year | Color (Legend/Background) | Marker Diameter In. (mm) | Markers Per Card | Material | Std. Pkg. Qty.* |
|--|--------|----------------------------|--|--------------------------|------------------|--------------------------------|-----------------|
| PEIP-A-00 PEIP-A-01 PEIP-A-02 PEIP-A-03 PEIP-A-04 | | 00 01 02 03 04 | White/Violet White/Green White/Blue White/Red White/Brown | 0.59 (15.0) | 10 | GMV10 Destructible Vinyl | 10 Cards |
| PEIP-A-BL PEIP-A-BR PEIP-A-GR PEIP-A-OR PEIP-A-VI PEIP-A-YL | | — | White/Blue White/Brown White/Green White/Orange White/Violet White/Yellow | 0.59 (15.0) | 10 | | |
| PEIP-C-03† PEIP-C-04† | | 98 thru 03 99 thru 04 | Black/Yellow | 1.18 (30.0) | 5 | | |
| PEIP-C-03-2† PEIP-C-04-2† | | 98 thru 03 99 thru 04 | Black/Yellow | 1.18 (30.0) | 5 | | |
| PEIP-D-00 PEIP-D-01 PEIP-D-02 PEIP-D-03 PEIP-D-04 | | 00 01 02 03 04 | White/Violet White/Green White/Blue White/Red White/Brown | 1.38 (35.0) | 5 | | |

*Order number of cards required in multiples of Std. Pkg. Qty.

†Also available in German, French, Italian, Dutch, Spanish, and Portuguese. Contact factory for part numbers.

Inspection Signs

- Ref. DIN 40010

| Part Number | Legend | Description | Color (Legend/Background) | Marker Height In. (mm) | Markers Per Card | Material | Std. Pkg. Qty.* |
|---|--------|----------------------------|---------------------------|---|----------------------------|-----------|-----------------|
| PESS-A-VDE1 PESS-B-VDE1 PESS-C-VDE1 PESS-D-VDE1 PESS-E-VDE1 | | VDE-Sign | Black/White | 0.49 (12.5) 0.63 (16.0) 0.79 (20.0) 0.98 (25.0) 1.24 (31.5) | 20 20 10 10 10 | Polyester | 10 Cards |
| PESS-A-VDE2 PESS-B-VDE2 PESS-C-VDE2 PESS-D-VDE2 PESS-E-VDE2 | | VDE-Spark Protection Sign | Black/White | 0.49 (12.5) 0.63 (16.0) 0.79 (20.0) 0.98 (25.0) 1.24 (31.5) | 20 20 10 10 10 | | |
| PESS-A-VDE3 PESS-B-VDE3 PESS-C-VDE3 PESS-D-VDE3 PESS-E-VDE3 | | VDE-Electronic certificate | Black/White | 0.49 (12.5) 0.63 (16.0) 0.79 (20.0) 0.98 (25.0) 1.24 (31.5) | 20 20 10 10 10 | | |
| PESS-A-CECC PESS-B-CECC PESS-C-CECC PESS-D-CECC PESS-E-CECC | | CEE certificate | Black/White | 0.49 (12.5) 0.63 (16.0) 0.79 (20.0) 0.98 (25.0) 1.24 (31.5) | 20 20 10 10 10 | | |
| PESS-A-GS1 PESS-B-GS1 PESS-C-GS1 PESS-D-GS1 PESS-E-GS1 | | VDE-GS-Symbol | Black/White | 0.49 (12.5) 0.63 (16.0) 0.79 (20.0) 0.98 (25.0) 1.24 (31.5) | 20 20 10 10 10 | | |
| PESS-A-GS2 PESS-B-GS2 PESS-C-GS2 PESS-D-GS2 PESS-E-GS2 | | VDE-GS-Symbol | Black/White | 0.49 (12.5) 0.63 (16.0) 0.79 (20.0) 0.98 (25.0) 1.24 (31.5) | 20 20 10 10 10 | | |

*Order number of cards required in multiples of Std. Pkg. Qty.

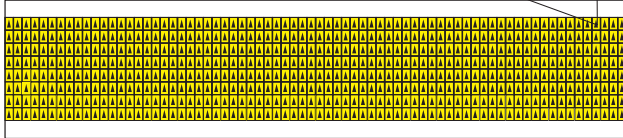

Inspection Arrows

| Part Number | Color (Legend/ Background) | Marker Size W X L In. (mm) | Material | Markers Per Card | Std. Pkg. Qty.* |
|-------------|----------------------------|----------------------------|------------------|------------------|-----------------|
| PARW125-RED | Black/Red | 0.13 x 0.19 (3.2 x 4.7) | GMC1 Vinyl Cloth | 576 | 25 Cards |
| PARW125-YEL | Black/Yellow | | | | |
| PARW125-WHT | Black/White | | | | |

*Order number of cards required in multiples of Std. Pkg. Qty.

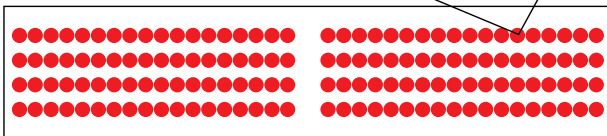
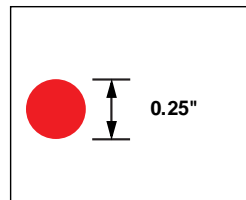
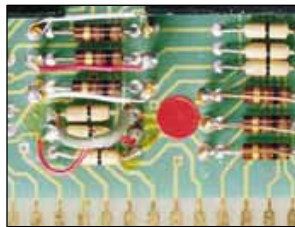

Marker Dots on Cards

| Part Number | NEMA Color | Marker Diameter In. (mm) | Material | Markers Per Card | Std. Pkg. Qty.* |
|-------------|-------------|--------------------------|------------|------------------|-----------------|
| PDOT25-BLK | Black | 0.25 (6.4) | GMV1 Vinyl | 144 | 25 Cards |
| PDOT25-BLU | Blue | | | | |
| PDOT25-DGN | Dark Green | | | | |
| PDOT25-GRY | Gray | | | | |
| PDOT25-LGN | Light Green | | | | |
| PDOT25-ORN | Orange | 0.25 (6.4) | GMV1 Vinyl | 144 | 25 Cards |
| PDOT25-RED | Red | | | | |
| PDOT25-WHT | White | | | | |
| PDOT25-YEL | Yellow | | | | |

*Order number of cards required in multiples of Std. Pkg. Qty.



PLD-62

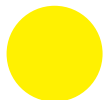

PLD-63



PLD-64



PLD-65

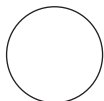

PLD-77



PLD-78

NEC 834-3(c)

Marker Dots in Dispenser

- Packaged in a dispenser for label protection and your convenience
- Made of durable laminated polyester film

| Part Number | Material | Marker Diameter In. (mm) | Markers Per Dispenser | Std. Pkg. Qty.* |
|-------------|-------------------------|--------------------------|-----------------------|-----------------|
| PLD-* | GMM Laminated Polyester | 0.75 (19.1) | 300 | 1 Disp. |

*Order number of dispensers required in multiples of Std. Pkg. qty.



Production Control Tags

- For organizing inventory, quality control, OEM, and maintenance applications
- Economical card stock tags for indoor or temporary use
- Package consists of 25 tags and 25 Panduit PLT1.5I Cable Ties (5.6" / 142 mm length)

| Part Number | Size W X L In. (mm) | Tags Per Pkg. | Std. Pkg. Qty.* |
|-------------|---------------------------|---------------|-----------------|
| PCT-***-Q | 5.75 x 3.00(146.1 x 76.2) | 25 | 1 Pkg. |

*Order number of packages required in multiples of Std. Pkg. Qty.

ACCEPTED

REMARKS _____

SIGNED BY _____ DATE _____

PCT-183-Q

CALIBRATED

REMARKS _____

SIGNED BY _____ DATE _____

PCT-184-Q

DUE FOR INSPECTION

REMARKS _____

SIGNED BY _____ DATE _____

PCT-185-Q

DUE FOR MAINTENANCE

REMARKS _____

SIGNED BY _____ DATE _____

PCT-186-Q

HOLD

REMARKS _____

SIGNED BY _____ DATE _____

PCT-187-Q

INSPECTED

REMARKS _____

SIGNED BY _____ DATE _____

PCT-188-Q

OK FOR SHIPMENT

REMARKS _____

SIGNED BY _____ DATE _____

PCT-189-Q

REJECTED

REMARKS _____

SIGNED BY _____ DATE _____

PCT-190-Q

REPAIR

REMARKS _____

SIGNED BY _____ DATE _____

PCT-191-Q

RETURN TO STOCK

REMARKS _____

SIGNED BY _____ DATE _____

PCT-192-Q

RETURN TO VENDOR

REMARKS _____

SIGNED BY _____ DATE _____

PCT-193-Q

RETURNED GOODS

REMARKS _____

SIGNED BY _____ DATE _____

PCT-83-Q

RE-WORK

REMARKS _____

SIGNED BY _____ DATE _____

PCT-194-Q

SAMPLE

REMARKS _____

SIGNED BY _____ DATE _____

PCT-195-Q

SCRAP

REMARKS _____

SIGNED BY _____ DATE _____

PCT-196-Q

SPECIAL INSTRUCTIONS

REMARKS _____

SIGNED BY _____ DATE _____

PCT-197-Q

TESTED

REMARKS _____

SIGNED BY _____ DATE _____

PCT-75-Q

TOP PRIORITY

REMARKS _____

SIGNED BY _____ DATE _____

PCT-91-Q

PCT-94-Q

PCT-95-Q



Fluorescent Tags



- Eye-catching colors draw immediate attention
- Communicate a variety of information quickly and effectively
- Economical card stock tags for indoor or temporary use
- Package consists of 25 tags and 25 Panduit PLT1.5I Cable Ties (5.6" / 142 mm length)

| Part Number | Size W X L In. (mm) | Tags Per Pkg. | Std. Pkg. Qty.* |
|-------------|---------------------------|---------------|-----------------|
| PCT-***-Q | 5.75 x 3.00(146.1 x 76.2) | 25 | 1 Pkg. |

*Order number of packages required in multiples of Std. Pkg. Qty.



PCT-174F-Q



PCT-172F-Q



PCT-173F-Q

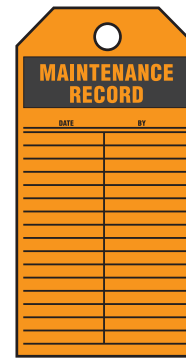

PCT-175F-Q

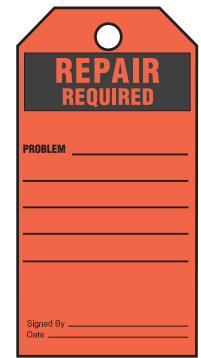

PCT-170F-Q

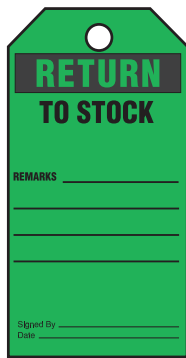

PCT-169F-Q

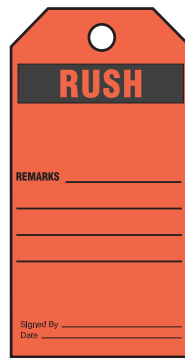

PCT-171F-Q

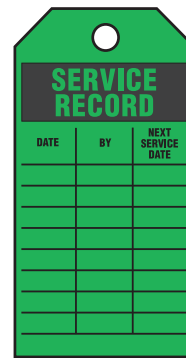

PCT-168F-Q



PCT-178F-Q

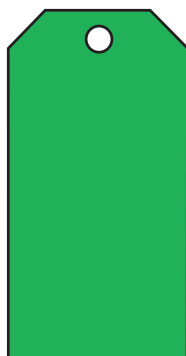

PCT-182F-Q



PCT-180F-Q



PCT-179F-Q

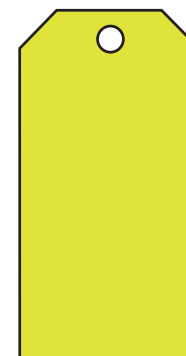

PCT-95F-Q

Blank Labels by Size

| Label Size Width x Length In. (mm) | Material | Color | Print Method* | Part Number | Page No. |
|--|-----------------------|--------|------------------|----------------|-------------|
| 0.20 x 0.65 (5.1 x 16.5) | Polyester | White | IJ | JL32Y-10 | 55 |
| 0.20 x 0.65 (5.1 x 16.5) | Vinyl Cloth | White | IJ | JL32C-10 | 55 |
| 0.25 x 0.25 (6.4 x 6.4) | Polyester | White | L | PLL-30-Y2-10 | 75 |
| 0.25 x 0.25 (6.4 x 6.4) | Polyester | White | TT | TTC1Y-10 | 42 |
| 0.25 x 0.65 (6.4 x 16.5) | Polyester | White | IJ | JL4Y-10 | 55 |
| 0.25 x 0.75 (6.4 x 19.1) | Polyester | White | IJ | JL274Y-10 | 55 |
| 0.25 x 0.80 (6.4 x 20.3) | Polyester | White | IJ | JL5Y-10 | 55 |
| 0.25 x 0.90 (6.4 x 22.9) | Polyester | White | IJ | JL287Y-10 | 55 |
| 0.25 x 1.00 (6.4 x 25.4) | Destructible Paper | White | IJ | JL7P-10 | 55 |
| 0.25 x 1.00 (6.4 x 25.4) | Polyester | White | IJ | JL7Y-10 | 55 |
| 0.25 x 1.00 (6.4 x 25.4) | Polyolefin | White | IJ | JL7PO-10 | 55 |
| 0.25 x 1.44 (6.4 x 36.6) | Polyester | White | DM | PDL-177 | 112 |
| 0.25 x 1.44 (6.4 x 36.6) | TEDLAR* | White | DM | PDL-179 | 112 |
| 0.25 x 1.44 (6.4 x 36.6) | Vinyl | White | DM | PDL-178 | 112 |
| 0.25 x 1.44 (6.4 x 36.6) | Vinyl Cloth | White | DM | PDL-176 | 112 |
| 0.25 x 1.50 (6.4 x 38.1) | Polyester | White | IJ | JL14Y-10 | 55 |
| 0.25 x 1.50 (6.4 x 38.1) | Polyolefin | White | IJ | JL14PO-10 | 55 |
| 0.25 x 1.50 (6.4 x 38.1) | Vinyl Cloth | White | IJ | JL14C-10 | 55 |
| 0.25 x 1.88 (6.4 x 47.6) | Polyester | White | IJ | JL15Y-10 | 55 |
| 0.28 x 0.25 (7.11 x 6.4) | Vinyl Cloth | White | DM | PDL-347 | 112 |
| 0.30 x 0.20 (7.6 x 5.1) | TEDLAR | White | DM | PDL-7966-10 | 112 |
| 0.30 x 0.25 (7.6 x 6.4) | Polyester | White | L | PLL-1-Y2-10 | 75 |
| 0.30 x 0.25 (7.6 x 6.4) | Polyester | Yellow | L | PLL-1-Y2Y-10 | 75 |
| 0.30 x 0.30 (7.6 x 7.6) | Polyester | White | DM | PDL-253 | 112 |
| 0.30 x 0.30 (7.6 x 7.6) | Polyester | White | DM | PDL-253-10 | 112 |
| 0.30 x 0.30 (7.6 x 7.6) | Polyimide | Amber | DM | PDL-252 | 112 |
| 0.30 x 0.30 (7.6 x 7.6) | Polyimide | Amber | DM | PDL-252-10 | 112 |
| 0.30 x 0.75 (7.6 x 19.1) | TEDLAR | White | DM | PDL-256 | 112 |
| 0.30 x 0.75 (7.6 x 19.1) | Vinyl Cloth | White | DM | PDL-254 | 112 |
| 0.30 x 0.94 (7.6 x 23.8) | TEDLAR | White | DM | PDL-259 | 112 |
| 0.30 x 0.94 (7.6 x 23.8) | Vinyl Cloth | White | DM | PDL-257 | 112 |
| 0.30 x 2.90 (7.6 x 73.7) | Polyolefin | White | IJ | JLEFPD-1 | 55 |
| 0.31 x 0.38 (7.87 x 9.5) | Vinyl Cloth | White | DM | PDL-351 | 112 |
| 0.31 x 0.50 (7.87 x 12.7) | Vinyl Cloth | White | DM | PDL-353 | 112 |
| 0.31 x 700 (7.87 x 17780) | Vinyl Cloth | White | DM | PDL-349 | 112 |
| 0.35 x 0.59 (9.0 x 15.0) | Polyester | Yellow | L | PEL-25-Y2Y-10 | 76 |
| 0.38 x 0.38 (9.5 x 9.5) | Destructible Vinyl | White | DM | PDL-263 | 112 |
| 0.38 x 0.38 (9.5 x 9.5) | Polyester | White | DM | PDL-264 | 112 |
| 0.38 x 0.38 (9.5 x 9.5) | Polyester | White | DM | PDL-264-10 | 112 |
| 0.38 x 0.38 (9.5 x 9.5) | Polyester | White | IJ | JL2Y-10 | 55 |
| 0.38 x 0.38 (9.5 x 9.5) | Polyester | White | L | PLL-2-Y2-10 | 72 |
| 0.38 x 0.38 (9.5 x 9.5) | Polyester | White | TT | TTC2Y-10 | 42 |
| 0.38 x 0.38 (9.5 x 9.5) | Polyester | Yellow | L | PLL-2-Y2Y-10 | 72 |
| 0.38 x 0.38 (9.5 x 9.5) | Polyimide | Amber | DM | PDL-262 | 112 |
| 0.38 x 0.38 (9.5 x 9.5) | Polyimide | Amber | DM | PDL-262-10 | 112 |
| 0.38 x 0.38 (9.5 x 9.5) | Vinyl Cloth | White | DM | PDL-260 | 112 |
| 0.38 x 1.00 (9.5 x 25.4) | Destructible Paper | White | IJ | JL8P-10 | 55 |
| 0.38 x 1.00 (9.5 x 25.4) | Polyester | White | IJ | JL8Y-10 | 55 |
| 0.38 x 1.00 (9.5 x 25.4) | Polyolefin | White | IJ | JL8PO-10 | 55 |
| 0.38 x 1.00 (9.5 x 25.4) | Vinyl Cloth | White | IJ | JL8C-10 | 55 |
| 0.38 x 1.44 (9.5 x 36.6) | Polyester | White | DM | PDL-181 | 112 |
| 0.38 x 1.44 (9.5 x 36.6) | TEDLAR | White | DM | PDL-183 | 112 |
| 0.38 x 1.44 (9.5 x 36.6) | Vinyl | White | DM | PDL-182 | 112 |

| Label Size Width x Length In. (mm) | Material | Color | Print Method* | Part Number | Page No. |
|--|--------------------------|--------|------------------|----------------|-------------|
| 0.38 x 1.44 (9.5 x 36.6) | Vinyl Cloth | White | DM | PDL-180 | 112 |
| 0.38 x 1.88 (9.5 x 47.6) | Polyolefin | White | IJ | JL16PO-2.5 | 55 |
| 0.38 x 1.88 (9.5 x 47.6) | Polyester | White | IJ | JL16Y-5 | 55 |
| 0.38 x 2.00 (9.5 x 50.8) | Polyester | White | IJ | JL111Y-5 | 55 |
| 0.38 x 2.00 (9.5 x 50.8) | Vinyl Cloth | White | IJ | JL111C-5 | 55 |
| 0.38 x 3.00 (9.5 x 76.2) | Polyolefin | White | IJ | JL19PO-1 | 55 |
| 0.38 x 3.00 (9.5 x 76.2) | Polyester | White | IJ | JL19Y-2.5 | 55 |
| 0.38 x 700 (9.5 x 17780) | Vinyl Cloth | White | DM | PDL-355 | 112 |
| 0.43 x 0.75 (11.0 x 19.1) | Polyester | Yellow | L | PEL-26-Y2Y-5 | 76 |
| 0.43 x 1.50 (11.0 x 38.1) | Polyester | Yellow | L | PEL-27-Y2Y-5 | 76 |
| 0.44 x 2.56 (11.1 x 65.0) | Polyester | White | DM | PDL-101 | 112 |
| 0.44 x 2.56 (11.1 x 65.0) | TEDLAR | White | DM | PDL-100 | 112 |
| 0.44 x 2.56 (11.1 x 65.0) | Vinyl | White | DM | PDL-103 | 112 |
| 0.44 x 2.56 (11.1 x 65.0) | Vinyl Cloth | White | DM | PDL-102 | 112 |
| 0.44 x 3.63 (11.1 x 92.1) | Polyester | White | DM | PDL-105 | 113 |
| 0.44 x 3.63 (11.1 x 92.1) | TEDLAR | White | DM | PDL-104 | 113 |
| 0.44 x 3.63 (11.1 x 92.1) | Vinyl | White | DM | PDL-107 | 113 |
| 0.44 x 3.63 (11.1 x 92.1) | Vinyl Cloth | White | DM | PDL-106 | 113 |
| 0.44 x 3.63 (11.1 x 92.1) | Vinyl Cloth | White | DM | PDL-106-1 | 113 |
| 0.44 x 3.63 (11.1 x 92.1) | Vinyl Cloth | White | DM | PDL-106-10 | 113 |
| 0.50 x 0.44 (12.7 x 11.1) | Destructible Vinyl | White | DM | PDL-46 | 113 |
| 0.50 x 0.44 (12.7 x 11.1) | Polyester | Silver | DM | PDL-48 | 113 |
| 0.50 x 0.44 (12.7 x 11.1) | Polyester | Silver | DM | PDL-48-1 | 113 |
| 0.50 x 0.44 (12.7 x 11.1) | Polyester | Silver | DM | PDL-48-10 | 113 |
| 0.50 x 0.44 (12.7 x 11.1) | Polyester | Silver | TT | TTC3YS-10 | 42 |
| 0.50 x 0.44 (12.7 x 11.1) | Polyester | White | DM | PDL-47 | 113 |
| 0.50 x 0.44 (12.7 x 11.1) | Polyester | White | DM | PDL-47-10 | 113 |
| 0.50 x 0.44 (12.7 x 11.1) | Polyester | White | L | PLL-31-Y2-10 | 72 |
| 0.50 x 0.44 (12.7 x 11.1) | Polyester | White | TT | TTC3Y-10 | 42 |
| 0.50 x 0.44 (12.7 x 11.1) | Removable Paper | White | DM | PDL-91 | 113 |
| 0.50 x 0.44 (12.7 x 11.1) | Removable Polyolefin | White | L | PLL-31-POR-10 | 72 |
| 0.50 x 0.44 (12.7 x 11.1) | Tamp. Evid. Polyester | Silver | TT | TTC3YST-10 | 42 |
| 0.50 x 0.44 (12.7 x 11.1) | Vinyl Cloth | White | DM | PDL-45 | 113 |
| 0.50 x 0.44 (12.7 x 11.1) | Vinyl Cloth | White | DM | PDL-45-1 | 113 |
| 0.50 x 0.44 (12.7 x 11.1) | Vinyl Cloth | White | DM | PDL-45-10 | 113 |
| 0.50 x 0.50 (12.7 x 12.7) | Polyester | Silver | L | PEL-9-Y1-10 | 76 |
| 0.50 x 0.50 (12.7 x 12.7) | Polyester | White | L | PEL-9-Y2-10 | 76 |
| 0.50 x 0.50 (12.7 x 12.7) | Tamp. Evid. Polyester | Silver | L | PEL-9-Y1C-10 | 76 |
| 0.50 x 0.75 (12.7 x 19.1) | Destructible Paper | White | DM | PDL-122 | 113 |
| 0.50 x 0.75 (12.7 x 19.1) | Destructible Paper | White | DM | PDL-89 | 113 |
| 0.50 x 0.75 (12.7 x 19.1) | Polyester | White | DM | PDL-121 | 113 |
| 0.50 x 0.75 (12.7 x 19.1) | Polyester | White | DM | PDL-90 | 113 |
| 0.50 x 0.75 (12.7 x 19.1) | Polyester | White | TT | TTC45Y-1 | 42 |
| 0.50 x 0.75 (12.7 x 19.1) | TEDLAR | White | DM | PDL-120 | 113 |
| 0.50 x 0.75 (12.7 x 19.1) | TEDLAR | White | DM | PDL-120-10 | 113 |
| 0.50 x 0.75 (12.7 x 19.1) | TEDLAR | White | DM | PDL-44 | 113 |
| 0.50 x 0.75 (12.7 x 19.1) | Vinyl Cloth | White | DM | PDL-119 | 113 |
| 0.50 x 0.75 (12.7 x 19.1) | Vinyl Cloth | White | DM | PDL-43 | 113 |
| 0.50 x 0.75 (12.7 x 19.1) | Vinyl Cloth | White | DM | PDL-43-10 | 113 |

* DM = Dot-Matrix, IJ = Ink Jet, L = Laser, TT = Thermal Transfer
 * TEDLAR is a registered trademark of E.I. DuPont Co.

Blank Labels by Size (cont.)

| Label Size Width x Length In. (mm) | Material | Color | Print Method* | Part Number | Page No. |
|---|--------------------|------------------|------------------|----------------|-------------|
| 0.50 x 0.80 (12.7 x 20.3) | Destructible Paper | White | IJ | JL172P-10 | 55 |
| 0.50 x 0.80 (12.7 x 20.3) | Polyester | White | IJ | JL172Y-10 | 55 |
| 0.50 x 0.94 (12.7 x 23.8) | TEDLAR ▲ | White | DM | PDL-267 | 113 |
| 0.50 x 0.94 (12.7 x 23.8) | Vinyl Cloth | White | DM | PDL-269 | 113 |
| 0.50 x 1.00 (12.7 x 25.4) | Destructible Paper | White | IJ | JL9P-10 | 55 |
| 0.50 x 1.00 (12.7 x 25.4) | Polyester | White | IJ | JL9Y-10 | 55 |
| 0.50 x 1.00 (12.7 x 25.4) | Polyolefin | White | IJ | JL9PO-10 | 55 |
| 0.50 x 1.00 (12.7 x 25.4) | Vinyl Cloth | White | IJ | JL9C-10 | 55 |
| 0.50 x 1.44 (12.7 x 36.5) | Polyester | White | DM | PDL-14 | 113 |
| 0.50 x 1.44 (12.7 x 36.5) | Polyester | White | DM | PDL-14-10 | 113 |
| 0.50 x 1.44 (12.7 x 36.5) | Polyester | White | DM | PDL-185 | 113 |
| 0.50 x 1.44 (12.7 x 36.5) | TEDLAR | White | DM | PDL-187 | 113 |
| 0.50 x 1.44 (12.7 x 36.5) | Vinyl | White | DM | PDL-15 | 113 |
| 0.50 x 1.44 (12.7 x 36.5) | Vinyl | White | DM | PDL-186 | 113 |
| 0.50 x 1.44 (12.7 x 36.5) | Vinyl Cloth | White | DM | PDL-13 | 113 |
| 0.50 x 1.44 (12.7 x 36.5) | Vinyl Cloth | White | DM | PDL-13-1 | 113 |
| 0.50 x 1.44 (12.7 x 36.5) | Vinyl Cloth | White | DM | PDL-13-10 | 113 |
| 0.50 x 1.44 (12.7 x 36.5) | Vinyl Cloth | White | DM | PDL-184 | 113 |
| 0.50 x 1.44 (12.7 x 36.5) With Horizontal Slit | Destructible Paper | White | DM | PDL-138 | 114 |
| 0.50 x 1.44 (12.7 x 36.5) With Horizontal Slit | Polyester | White | DM | PDL-136 | 114 |
| 0.50 x 1.44 (12.7 x 36.5) With Horizontal Slit | TEDLAR | White | DM | PDL-137 | 114 |
| 0.50 x 1.44 (12.7 x 36.5) With Horizontal Slit | Vinyl Cloth | White | DM | PDL-135 | 114 |
| 0.50 x 1.50 (12.7 x 38.1) | Destructible Paper | White | IJ | JL12P-5 | 55 |
| 0.50 x 1.50 (12.7 x 38.1) | Polyester | White | IJ | JL12Y-5 | 55 |
| 0.50 x 1.50 (12.7 x 38.1) | Polyolefin | White | L | PLL-33-PO-5 | 72 |
| 0.50 x 7.88 (12.7 x 200.0) | Polyester | White | TT | TTC-DS110-1 | 42 |
| 0.56 x 0.19 (14.3 x 4.8) | Polyolefin | White | IJ | JL24PO-5 | 55 |
| 0.56 x 0.19 (14.3 x 4.8) | Polyester | Clear | DM | PDL-402-10 | 114 |
| 0.56 x 0.19 (14.3 x 4.8) | Polyester | Clear | DM | PDL-402-D | 114 |
| 0.56 x 0.19 (14.3 x 4.8) | Polyester | Clear | L | PLL-24-Y3-1 | 72 |
| 0.56 x 0.19 (14.3 x 4.8) | Polyester | Clear | L | PLL-24-Y3-5 | 72 |
| 0.56 x 0.19 (14.3 x 4.8) | Polyester | White | DM | PDL-405-10 | 114 |
| 0.56 x 0.19 (14.3 x 4.8) | Polyester | White | DM | PDL-405-D | 114 |
| 0.56 x 0.19 (14.3 x 4.8) | Polyester | White | L | PLL-24-Y2-1 | 72 |
| 0.56 x 0.19 (14.3 x 4.8) | Polyester | White | L | PLL-24-Y2-5 | 72 |
| 0.56 x 0.25 (14.3 x 6.4) | Polyester | Clear | L | PEL-29-Y3M-10 | 76 |
| 0.56 x 0.25 (14.3 x 6.4) | Polyester | White | L | PEL-29-Y2-10 | 76 |
| 0.56 x 0.56 (14.3 x 14.3) | Polyester | Clear | L | PEL-28-Y3M-5 | 76 |
| 0.56 x 0.56 (14.3 x 14.3) | Polyester | White | L | PEL-28-Y2-5 | 76 |
| 0.56 x 0.56 (14.3 x 14.3) | Polyester | Clear | DM | PDL-401 | 114 |
| 0.56 x 0.56 (14.3 x 14.3) | Polyester | Clear | DM | PDL-401-10 | 114 |
| 0.56 x 0.56 (14.3 x 14.3) | Polyester | Clear | DM | PDL-401-D | 114 |
| 0.56 x 0.56 (14.3 x 14.3) | Polyester | Clear | L | PLL-23-Y3-1 | 72 |
| 0.56 x 0.56 (14.3 x 14.3) | Polyester | Clear | L | PLL-23-Y3-5 | 72 |
| 0.56 x 0.56 (14.3 x 14.3) | Polyester | Electrical Ivory | DM | PDL-400 | 114 |
| 0.56 x 0.56 (14.3 x 14.3) | Polyester | White | DM | PDL-406-10 | 114 |
| 0.56 x 0.56 (14.3 x 14.3) | Polyester | White | DM | PDL-406-D | 114 |

| Label Size Width x Length In. (mm) | Material | Color | Print Method* | Part Number | Page No. |
|---|-----------------------|-------------|------------------|----------------|-------------|
| 0.56 x 0.56 (14.3 x 14.3) | Polyester | White | L | PLL-23-Y2-1 | 72 |
| 0.56 x 0.56 (14.3 x 14.3) | Polyester | White | L | PLL-23-Y2-5 | 72 |
| 0.56 x 0.56 (14.3 x 14.3) | Polyolefin | White | IJ | JL23PO-1 | 55 |
| 0.59 x 0.35 (15.0 x 9.0) | Vinyl Cloth | White | DM | PDL-194 | 114 |
| 0.59 x 0.35 (15.0 x 9.0) | Vinyl Cloth | Yellow | DM | PDL-193 | 114 |
| 0.61 x 0.33 (15.5 x 8.4) | Polyolefin | White | IJ | JLCPL-1 | 55 |
| 0.65 x 0.20 (16.5 x 5.1) | TEDLAR | White | TT | TTC4T-10 | 114 |
| 0.65 x 0.20 (16.5 x 5.1) | Destructible Paper | White | DM | PDL-82 | 114 |
| 0.65 x 0.20 (16.5 x 5.1) | Destructible Vinyl | White | DM | PDL-35 | 114 |
| 0.65 x 0.20 (16.5 x 5.1) | Destructible Vinyl | White | DM | PDL-35-1 | 114 |
| 0.65 x 0.20 (16.5 x 5.1) | Destructible Vinyl | White | DM | PDL-35-10 | 114 |
| 0.65 x 0.20 (16.5 x 5.1) | Polyester | Silver | DM | PDL-234 | 114 |
| 0.65 x 0.20 (16.5 x 5.1) | Polyester | Silver | DM | PDL-234-10 | 114 |
| 0.65 x 0.20 (16.5 x 5.1) | Polyester | White | DM | PDL-36 | 114 |
| 0.65 x 0.20 (16.5 x 5.1) | Polyester | White | DM | PDL-36-10 | 72 |
| 0.65 x 0.20 (16.5 x 5.1) | Polyester | White | L | PLL-32-Y2-10 | 42 |
| 0.65 x 0.20 (16.5 x 5.1) | Polyester | White | TT | TTC4Y-10 | 72 |
| 0.65 x 0.20 (16.5 x 5.1) | Polyester | Yellow | L | PLL-32-Y2Y-10 | 114 |
| 0.65 x 0.20 (16.5 x 5.1) | Polyimide | Amber | DM | PDL-233 | 114 |
| 0.65 x 0.20 (16.5 x 5.1) | Polyimide | Amber | DM | PDL-233-10 | 42 |
| 0.65 x 0.20 (16.5 x 5.1) | Tamp. Evid. Polyester | Silver | TT | TTC4YST-10 | 114 |
| 0.65 x 0.20 (16.5 x 5.1) | TEDLAR | White | DM | PDL-83 | 114 |
| 0.65 x 0.20 (16.5 x 5.1) | TEDLAR | White | DM | PDL-83-10 | 42 |
| 0.65 x 0.20 (16.5 x 5.1) | Vinyl | White | DM | PDL-189 | 114 |
| 0.65 x 0.20 (16.5 x 5.1) | Vinyl Cloth | White | DM | PDL-34 | 114 |
| 0.65 x 0.20 (16.5 x 5.1) | Vinyl Cloth | White | DM | PDL-34-1 | 114 |
| 0.65 x 0.20 (16.5 x 5.1) | Vinyl Cloth | White | DM | PDL-34-10 | 114 |
| 0.65 x 0.20 (16.5 x 5.1) With Tamper Resistant Slits | Polyester | White | DM | PDL-269 | 114 |
| 0.65 x 0.25 (16.5 x 6.4) | Polyester | White | L | PLL-4-Y2-10 | 72 |
| 0.65 x 0.25 (16.5 x 6.4) | Polyester | Yellow | L | PLL-4-Y2Y-10 | 72 |
| 0.70 x 0.25 (17.8 x 6.4) | Polyester | Silver | L | PEL-1-Y1-10 | 76 |
| 0.70 x 0.25 (17.8 x 6.4) | Polyester | White | L | PEL-1-Y2-10 | 76 |
| 0.70 x 0.33 (17.8 x 8.5) | Polyester | Silver | L | PEL-4-Y1-10 | 76 |
| 0.70 x 0.33 (17.8 x 8.5) | Polyester | White | L | PEL-4-Y2-10 | 76 |
| 0.70 x 0.33 (17.8 x 8.5) | Polyester | Yellow | L | PEL-4-Y2Y-10 | 76 |
| 0.70 x 0.33 (17.8 x 8.5) | Tamp. Evid. Polyester | Silver | L | PEL-4-Y1C-10 | 76 |
| 0.70 x 0.50 (17.8 x 12.7) | Polyester | Matte Clear | L | PEL-10-Y3M-5 | 76 |
| 0.70 x 0.50 (17.8 x 12.7) | Polyester | Silver | L | PEL-10-Y1-5 | 76 |
| 0.70 x 0.50 (17.8 x 12.7) | Polyester | White | L | PEL-10-Y2-5 | 76 |
| 0.70 x 0.50 (17.8 x 12.7) | Polyester | Yellow | L | PEL-10-Y2Y-5 | 76 |
| 0.75 x 0.25 (19.1 x 6.4) | Destructible Paper | White | DM | PDL-85 | 115 |
| 0.75 x 0.25 (19.1 x 6.4) | Destructible Vinyl | White | DM | PDL-273 | 115 |
| 0.75 x 0.25 (19.1 x 6.4) | Destructible Vinyl | White | DM | PDL-38 | 115 |
| 0.75 x 0.25 (19.1 x 6.4) | Destructible Vinyl | White | DM | PDL-38-10 | 115 |
| 0.75 x 0.25 (19.1 x 6.4) | Polyester | Silver | DM | PDL-236 | 115 |
| 0.75 x 0.25 (19.1 x 6.4) | Polyester | Silver | DM | PDL-236-10 | 115 |

* DM = Dot-Matrix, IJ = Ink Jet, L = Laser, TT = Thermal Transfer
 ▲ TEDLAR is a registered trademark of E.I. DuPont Co.

Blank Labels by Size (cont.)

| Label Size Width x Length In. (mm) | Material | Color | Print Method* | Part Number | Page No. |
|---|--------------------------|--------|------------------|----------------|-------------|
| 0.75 x 0.25 (19.1 x 6.4) | Polyester | Silver | DM | PDL-275 | 115 |
| 0.75 x 0.25 (19.1 x 6.4) | Polyester | Silver | TT | TTC5YS-10 | 42 |
| 0.75 x 0.25 (19.1 x 6.4) | Polyester | White | DM | PDL-274 | 115 |
| 0.75 x 0.25 (19.1 x 6.4) | Polyester | White | DM | PDL-274-10 | 115 |
| 0.75 x 0.25 (19.1 x 6.4) | Polyester | White | DM | PDL-39 | 115 |
| 0.75 x 0.25 (19.1 x 6.4) | Polyester | White | DM | PDL-39-10 | 115 |
| 0.75 x 0.25 (19.1 x 6.4) | Polyester | White | TT | TTC5Y-10 | 42 |
| 0.75 x 0.25 (19.1 x 6.4) | Polyimide | Amber | DM | PDL-235 | 115 |
| 0.75 x 0.25 (19.1 x 6.4) | Polyimide | Amber | DM | PDL-235-10 | 115 |
| 0.75 x 0.25 (19.1 x 6.4) | Polyimide | Amber | DM | PDL-272 | 115 |
| 0.75 x 0.25 (19.1 x 6.4) | Tamp. Evid. Polyester | Silver | TT | TTC5YST-10 | 42 |
| 0.75 x 0.25 (19.1 x 6.4) | TEDLAR * | White | DM | PDL-84 | 115 |
| 0.75 x 0.25 (19.1 x 6.4) | TEDLAR | White | TT | TTC5T-10 | 42 |
| 0.75 x 0.25 (19.1 x 6.4) | Vinyl | White | DM | PDL-190 | 115 |
| 0.75 x 0.25 (19.1 x 6.4) | Vinyl Cloth | White | DM | PDL-270 | 115 |
| 0.75 x 0.25 (19.1 x 6.4) | Vinyl Cloth | White | DM | PDL-37 | 115 |
| 0.75 x 0.25 (19.1 x 6.4) | Vinyl Cloth | White | DM | PDL-37-1 | 115 |
| 0.75 x 0.25 (19.1 x 6.4) | Vinyl Cloth | White | DM | PDL-37-10 | 115 |
| 0.75 x 0.25 (19.1 x 6.4) | Vinyl Cloth | White | DM | PDL-37-50 | 115 |
| 0.75 x 0.25 (19.1 x 6.4) With Tamper Resistant Slits | Polyester | White | DM | PDL-277 | 115 |
| 0.75 x 0.25 (19.1 x 6.4) With Tamper Resistant Slits | Polyester | White | DM | PDL-277-10 | 115 |
| 0.75 x 0.25 (19.1 x 6.4) With Tamper Resistant Slits | Polyimide | Amber | DM | PDL-276 | 115 |
| 0.75 x 0.50 (19.1 x 12.7) | Polyester | White | IJ | JL3Y-10 | 55 |
| 0.75 x 0.50 (19.1 x 12.7) | Vinyl Cloth | White | IJ | JL3C-10 | 55 |
| 0.75 x 1.00 (19.1 x 25.4) | Destructible Paper | White | IJ | JL10P-5 | 55 |
| 0.75 x 1.00 (19.1 x 25.4) | Polyester | White | IJ | JL10Y-5 | 55 |
| 0.75 x 1.00 (19.1 x 25.4) | Vinyl Cloth | White | IJ | JL10C-5 | 55 |
| 0.75 x 1.25 (19.1 x 31.8) | Polyester | White | IJ | JL901Y-5 | 55 |
| 0.75 x 1.25 (19.1 x 31.8) | Polyolefin | White | IJ | JL901P0-5 | 55 |
| 0.75 x 1.25 (19.1 x 31.8) | Vinyl Cloth | White | IJ | JL901C-5 | 55 |
| 0.75 x 1.50 (19.1 x 38.1) | Destructible Paper | White | IJ | JL35P-2.5 | 55 |
| 0.75 x 1.50 (19.1 x 38.1) | Polyester | White | IJ | JL35Y-2.5 | 55 |
| 0.75 x 1.50 (19.1 x 38.1) | Polyolefin | White | IJ | JL35P0-2.5 | 55 |
| 0.75 x 1.50 (19.1 x 38.1) | Vinyl Cloth | White | IJ | JL35C-2.5 | 55 |
| 0.79 x 0.31 (20.0 x 8.0) | Polyester | Yellow | L | PEL-24-Y2Y-10 | 76 |
| 0.79 x 0.32 (20.0 x 8.0) | Vinyl Cloth | White | DM | PDL-192 | 115 |
| 0.79 x 0.32 (20.0 x 8.0) | Vinyl Cloth | Yellow | DM | PDL-191 | 115 |
| 0.80 x 0.20 (20.3 x 5.1) | Polyester | White | DM | PDL-279 | 115 |
| 0.80 x 0.20 (20.3 x 5.1) | Polyester | White | DM | PDL-279-10 | 115 |
| 0.80 x 0.20 (20.3 x 5.1) | Polyester | White | L | PLL-20-Y2-10 | 72 |
| 0.80 x 0.20 (20.3 x 5.1) | Polyester | Yellow | L | PLL-20-Y2Y-10 | 72 |
| 0.80 x 0.20 (20.3 x 5.1) | Polyimide | Amber | DM | PDL-278 | 115 |
| 0.80 x 0.25 (20.3 x 6.4) | Destructible Paper | White | DM | PDL-167 | 115 |
| 0.80 x 0.25 (20.3 x 6.4) | Polyester | White | L | PLL-5-Y2-10 | 72 |
| 0.80 x 0.25 (20.3 x 6.4) | Polyester | Yellow | L | PLL-5-Y2Y-10 | 72 |
| 0.80 x 0.33 (20.3 x 8.5) | Polyester | Silver | L | PEL-5-Y1-10 | 76 |
| 0.80 x 0.33 (20.3 x 8.5) | Polyester | White | L | PEL-5-Y2-10 | 76 |
| 0.80 x 0.33 (20.3 x 8.5) | Polyester | Yellow | L | PEL-5-Y2Y-10 | 76 |
| 0.80 x 0.50 (20.3 x 12.7) | Destructible Paper | White | DM | PDL-174 | 115 |

| Label Size Width x Length In. (mm) | Material | Color | Print Method* | Part Number | Page No. |
|---|-----------------------|--------|------------------|----------------|-------------|
| 0.80 x 0.50 (20.3 x 12.7) | Polyester | White | DM | PDL-172 | 115 |
| 0.80 x 0.50 (20.3 x 12.7) | Polyester | White | DM | PDL-172-10 | 115 |
| 0.80 x 0.50 (20.3 x 12.7) | Polyester | White | L | PLL-6-Y2-10 | 72 |
| 0.80 x 0.50 (20.3 x 12.7) | Polyester | White | L | PLL-6-Y2-5 | 72 |
| 0.80 x 0.50 (20.3 x 12.7) | Polyester | Yellow | L | PLL-6-Y2Y-10 | 72 |
| 0.80 x 0.50 (20.3 x 12.7) | Polyester | Yellow | L | PLL-6-Y2Y-5 | 72 |
| 0.80 x 0.50 (20.3 x 12.7) | Polyimide | Amber | DM | PDL-173 | |
| 0.80 x 0.50 (20.3 x 12.7) | Removable Paper | White | DM | PDL-170 | 115 |
| 0.80 x 0.50 (20.3 x 12.7) | Removable Paper | White | DM | PDL-170-10 | 115 |
| 0.80 x 0.50 (20.3 x 12.7) | Vinyl | White | DM | PDL-171 | 115 |
| 0.80 x 0.50 (20.3 x 12.7) | Polyester | White | DM | PDL-172R | 115 |
| 0.80 x 0.94 (20.3 x 23.8) | TEDLAR | White | DM | PDL-282 | 116 |
| 0.80 x 0.94 (20.3 x 23.8) | Vinyl Cloth | White | DM | PDL-280 | 116 |
| 0.80 x 0.94 (20.3 x 23.8) | Vinyl Cloth | White | DM | PDL-280-10 | 116 |
| 0.80 x 1.44 (20.3 x 36.5) | TEDLAR | White | DM | PDL-10 | 116 |
| 0.80 x 1.44 (20.3 x 36.5) | TEDLAR | White | DM | PDL-10-1 | 116 |
| 0.80 x 1.44 (20.3 x 36.5) | Vinyl | White | DM | PDL-11 | 116 |
| 0.80 x 1.44 (20.3 x 36.5) | Vinyl Cloth | White | DM | PDL-9 | 116 |
| 0.80 x 1.44 (20.3 x 36.5) | Vinyl Cloth | White | DM | PDL-9-10 | 116 |
| 0.80 x 1.44 (20.3 x 36.5) | Vinyl Cloth | White | DM | PDL-9-10T | 116 |
| 0.80 x 1.50 (20.3 x 38.1) | Polyolefin | White | IJ | JL42P0-1 | 56 |
| 0.81 x 0.50 (20.7 x 12.7) | Polyester | Silver | DM | PDL-175 | 116 |
| 0.83 x 1.88 (21.2 x 47.6) | Destructible Paper | White | IJ | JL17P-2.5 | 56 |
| 0.83 x 1.88 (21.2 x 47.6) | Polyester | White | IJ | JL17Y-2.5 | 56 |
| 0.83 x 1.88 (21.2 x 47.6) | Polyolefin | White | IJ | JL17P0-1 | 56 |
| 0.83 x 1.88 (21.2 x 47.6) | Polyolefin | White | IJ | JL17P0-2.5 | 56 |
| 0.90 x 0.25 (22.9 x 6.4) | Destructible Paper | White | DM | PDL-67 | 116 |
| 0.90 x 0.25 (22.9 x 6.4) | Destructible Paper | White | DM | PDL-92 | 116 |
| 0.90 x 0.25 (22.9 x 6.4) | Polyester | Silver | DM | PDL-68 | 116 |
| 0.90 x 0.25 (22.9 x 6.4) | Polyester | White | DM | PDL-285 | 116 |
| 0.90 x 0.25 (22.9 x 6.4) | Polyester | White | DM | PDL-94 | 116 |
| 0.90 x 0.25 (22.9 x 6.4) | Polyester | White | DM | PDL-94-1 | 116 |
| 0.90 x 0.25 (22.9 x 6.4) | Polyester | White | DM | PDL-94-10 | 116 |
| 0.90 x 0.25 (22.9 x 6.4) | Polyester | White | TT | TTC6Y-10 | 42 |
| 0.90 x 0.25 (22.9 x 6.4) | Polyimide | Amber | DM | PDL-283 | 116 |
| 0.90 x 0.25 (22.9 x 6.4) | Polyimide | Amber | DM | PDL-50 | 116 |
| 0.90 x 0.25 (22.9 x 6.4) | Polyimide | Amber | DM | PDL-50-10 | 116 |
| 0.90 x 0.25 (22.9 x 6.4) | TEDLAR | White | DM | PDL-23 | 116 |
| 0.90 x 0.25 (22.9 x 6.4) | TEDLAR | White | DM | PDL-23-1 | 116 |
| 0.90 x 0.25 (22.9 x 6.4) | TEDLAR | White | DM | PDL-23-10 | 116 |
| 0.90 x 0.25 (22.9 x 6.4) | TEDLAR | White | DM | PDL-284 | 116 |
| 0.90 x 0.25 (22.9 x 6.4) | TEDLAR | White | DM | PDL-49 | 116 |
| 0.90 x 0.25 (22.9 x 6.4) | TEDLAR | White | DM | PDL-49-10 | 116 |
| 0.90 x 0.25 (22.9 x 6.4) | TEDLAR | White | TT | TTC6T-10 | 42 |
| 0.90 x 0.25 (22.9 x 6.4) | Vinyl Cloth | White | DM | PDL-66 | 116 |
| 0.90 x 0.25 (22.9 x 6.4) | Vinyl Cloth | White | DM | PDL-93 | 116 |
| 0.90 x 0.25 (22.9 x 6.4) With Tamper Resistant Slits | Polyester | White | DM | PDL-287 | 116 |
| 0.90 x 0.25 (22.9 x 6.4) With Tamper Resistant Slits | Polyimide | Amber | DM | PDL-286 | 116 |
| 0.98 x 0.59 (25.0 x 15.0) | TEDLAR | White | DM | PDL-4565-1 | 116 |

* DM = Dot-Matrix, IJ = Ink Jet, L = Laser, TT = Thermal Transfer
 * TEDLAR is a registered trademark of E.I. DuPont Co.

Blank Labels by Size (cont.)

| Label Size Width x Length In. (mm) | Material | Color | Print Method* | Part Number | Page No. |
|--|---------------------------|-------------|------------------|----------------|-------------|
| 1.00 x 0.25 (25.4 x 6.4) | Polyester | Matte Clear | L | PEL-2-Y3M-10 | 76 |
| 1.00 x 0.25 (25.4 x 6.4) | Polyester | Silver | L | PEL-2-Y1-10 | 76 |
| 1.00 x 0.25 (25.4 x 6.4) | Polyester | White | L | PEL-2-Y2-10 | 76 |
| 1.00 x 0.25 (25.4 x 6.4) | Polyester | White | L | PLL-7-Y2-10 | 72 |
| 1.00 x 0.25 (25.4 x 6.4) | Polyester | Yellow | L | PEL-2-Y2Y-10 | 76 |
| 1.00 x 0.25 (25.4 x 6.4) | Polyester | Yellow | L | PLL-7-Y2Y-10 | 76 |
| 1.00 x 0.33 (25.4 x 8.5) | Polyester | Silver | L | PEL-6-Y1-5 | 76 |
| 1.00 x 0.33 (25.4 x 8.5) | Polyester | White | L | PEL-6-Y2-5 | 76 |
| 1.00 x 0.33 (25.4 x 8.5) | Tamp. Evid. Polyester | Silver | L | PEL-6-Y1C-5 | 76 |
| 1.00 x 0.38 (25.4 x 9.5) | Destructible Paper | White | DM | PDL-74 | 116 |
| 1.00 x 0.38 (25.4 x 9.5) | Polyester | Silver | TT | TTC7YS-10 | 42 |
| 1.00 x 0.38 (25.4 x 9.5) | Polyester | White | DM | PDL-31 | 116 |
| 1.00 x 0.38 (25.4 x 9.5) | Polyester | White | DM | PDL-31-10 | 116 |
| 1.00 x 0.38 (25.4 x 9.5) | Polyester | White | L | PLL-8-Y2-10 | 72 |
| 1.00 x 0.38 (25.4 x 9.5) | Polyester | White | L | PLL-8-Y2-5 | 72 |
| 1.00 x 0.38 (25.4 x 9.5) | Polyester | White | TT | TTC7Y-10 | 42 |
| 1.00 x 0.38 (25.4 x 9.5) | Polyester | Yellow | L | PLL-8-Y2Y-10 | 72 |
| 1.00 x 0.38 (25.4 x 9.5) | Polyester | Yellow | L | PLL-8-Y2Y-5 | 72 |
| 1.00 x 0.38 (25.4 x 9.5) | Polyolefin | White | L | PLL-8-PO-10 | 72 |
| 1.00 x 0.38 (25.4 x 9.5) | TEDLAR * | White | DM | PDL-75 | 116 |
| 1.00 x 0.38 (25.4 x 9.5) | Vinyl Cloth | White | DM | PDL-30 | 116 |
| 1.00 x 0.38 (25.4 x 9.5) | Vinyl Cloth | White | DM | PDL-30-1 | 116 |
| 1.00 x 0.38 (25.4 x 9.5) | Vinyl Cloth | White | DM | PDL-30-10 | 116 |
| 1.00 x 0.50 (25.4 x 12.7) | Aluminum | Silver | DM | PDL-97 | 117 |
| 1.00 x 0.50 (25.4 x 12.7) | Destructible Polyethylene | White | TT | TTC8ET-10 | 42 |
| 1.00 x 0.50 (25.4 x 12.7) | Destructible Vinyl | White | DM | PDL-21 | 117 |
| 1.00 x 0.50 (25.4 x 12.7) | Destructible Vinyl | White | DM | PDL-21-1 | 117 |
| 1.00 x 0.50 (25.4 x 12.7) | Destructible Vinyl | White | DM | PDL-21-10 | 117 |
| 1.00 x 0.50 (25.4 x 12.7) | Destructible Vinyl | White | DM | PDL-7294-1 | 117 |
| 1.00 x 0.50 (25.4 x 12.7) | Polyester | Clear | DM | PDL-363 | 117 |
| 1.00 x 0.50 (25.4 x 12.7) | Polyester | Clear | L | PLL-9-Y3C-5 | 73 |
| 1.00 x 0.50 (25.4 x 12.7) | Polyester | Clear | TT | TTC8YC-10 | 42 |
| 1.00 x 0.50 (25.4 x 12.7) | Polyester | Silver | DM | PDL-158 | 117 |
| 1.00 x 0.50 (25.4 x 12.7) | Polyester | Silver | DM | PDL-22 | 117 |
| 1.00 x 0.50 (25.4 x 12.7) | Polyester | Silver | DM | PDL-22-1 | 117 |
| 1.00 x 0.50 (25.4 x 12.7) | Polyester | Silver | DM | PDL-22-10 | 117 |
| 1.00 x 0.50 (25.4 x 12.7) | Polyester | Silver | L | PEL-11-Y1-5 | 76 |
| 1.00 x 0.50 (25.4 x 12.7) | Polyester | Silver | L | PLL-9-Y2S-10 | 73 |
| 1.00 x 0.50 (25.4 x 12.7) | Polyester | Silver | TT | TTC8YS-10 | 42 |
| 1.00 x 0.50 (25.4 x 12.7) | Polyester | White | DM | PDL-157 | 117 |
| 1.00 x 0.50 (25.4 x 12.7) | Polyester | White | DM | PDL-20 | 117 |
| 1.00 x 0.50 (25.4 x 12.7) | Polyester | White | DM | PDL-20-1 | 117 |
| 1.00 x 0.50 (25.4 x 12.7) | Polyester | White | DM | PDL-20-10 | 117 |
| 1.00 x 0.50 (25.4 x 12.7) | Polyester | White | L | PEL-11-Y2-5 | 76 |
| 1.00 x 0.50 (25.4 x 12.7) | Polyester | White | L | PLL-9-Y2-10 | 73 |
| 1.00 x 0.50 (25.4 x 12.7) | Polyester | White | L | PLL-9-Y2-5 | 73 |
| 1.00 x 0.50 (25.4 x 12.7) | Polyester | White | TT | TTC8Y-10 | 42 |

| Label Size Width x Length In. (mm) | Material | Color | Print Method* | Part Number | Page No. |
|--|-----------------------|-------------|------------------|----------------|-------------|
| 1.00 x 0.50 (25.4 x 12.7) | Polyester | Yellow | L | PLL-9-Y2Y-10 | 73 |
| 1.00 x 0.50 (25.4 x 12.7) | Polyester | Yellow | L | PLL-9-Y2Y-5 | 73 |
| 1.00 x 0.50 (25.4 x 12.7) | Polyester | Yellow | L | PEL-11-Y2Y-5 | 76 |
| 1.00 x 0.50 (25.4 x 12.7) | Polyimide | Amber | DM | PDL-98 | 117 |
| 1.00 x 0.50 (25.4 x 12.7) | Removable Paper | White | DM | PDL-65 | 117 |
| 1.00 x 0.50 (25.4 x 12.7) | Removable Polyolefin | White | L | PLL-9-POR-10 | 73 |
| 1.00 x 0.50 (25.4 x 12.7) | Tamp. Evid. Polyester | Silver | L | PEL-11-Y1C-5 | 76 |
| 1.00 x 0.50 (25.4 x 12.7) | Tamp. Evid. Polyester | Silver | TT | TTC8YST-10 | 42 |
| 1.00 x 0.50 (25.4 x 12.7) | TEDLAR | White | DM | PDL-99 | 117 |
| 1.00 x 0.50 (25.4 x 12.7) | TEDLAR | White | DM | PDL-99-10 | 117 |
| 1.00 x 0.50 (25.4 x 12.7) | TEDLAR | White | TT | TTC8T-10 | 42 |
| 1.00 x 0.50 (25.4 x 12.7) | TEDLAR | Yellow | DM | PDL-230 | 117 |
| 1.00 x 0.50 (25.4 x 12.7) | Vinyl | White | DM | PDL-188 | 117 |
| 1.00 x 0.50 (25.4 x 12.7) | Vinyl Cloth | White | DM | PDL-19 | 117 |
| 1.00 x 0.50 (25.4 x 12.7) | Vinyl Cloth | White | DM | PDL-19-1 | 117 |
| 1.00 x 0.50 (25.4 x 12.7) | Vinyl Cloth | White | DM | PDL-19-10 | 117 |
| 1.00 x 0.75 (25.4 x 19.1) | Polyester | Clear | L | PLL-10-Y3C-2.5 | 73 |
| 1.00 x 0.75 (25.4 x 19.1) | Polyester | White | L | PLL-10-Y2-2.5 | 73 |
| 1.00 x 0.75 (25.4 x 19.1) | Polyolefin | White | L | PLL-10-PO-5 | 73 |
| 1.00 x 0.75 (25.4 x 19.1) | TEDLAR | White | DM | PDL-290 | 117 |
| 1.00 x 0.75 (25.4 x 19.1) | TEDLAR | White | DM | PDL-290-1 | 117 |
| 1.00 x 0.75 (25.4 x 19.1) | Vinyl Cloth | White | DM | PDL-288 | 117 |
| 1.00 x 0.94 (25.4 x 23.8) | Litho Paper | White | DM | PL115-12 | 105 |
| 1.00 x 0.94 (25.4 x 23.8) | TEDLAR | White | DM | PDL-293 | 117 |
| 1.00 x 0.94 (25.4 x 23.8) | Vinyl Cloth | White | DM | PDL-291 | 117 |
| 1.00 x 1.00 (25.4 x 25.4) | Polyester | Clear | L | PLL-11-Y3C-2.5 | 73 |
| 1.00 x 1.00 (25.4 x 25.4) | Polyester | White | L | PLL-11-Y2-2.5 | 73 |
| 1.00 x 1.33 (25.4 x 33.8) | Polyester | White | L | PLL-12-Y2-1 | 73 |
| 1.00 x 1.33 (25.4 x 33.8) | Polyester | White | L | PLL-12-Y2-2.5 | 73 |
| 1.00 x 1.44 (25.4 x 36.5) With Horizontal Perforation | TEDLAR | White | DM | PDL-296 | 117 |
| 1.00 x 1.44 (25.4 x 36.5) With Horizontal Perforation | Vinyl Cloth | White | DM | PDL-294 | 117 |
| 1.00 x 1.75 (25.4 x 44.5) | Destructible Paper | White | IJ | JL902P-2.5 | 56 |
| 1.00 x 1.75 (25.4 x 44.5) | Polyester | White | IJ | JL902Y-2.5 | 56 |
| 1.13 x 0.53 (28.6 x 13.5) | TEDLAR | White | DM | PDL-4674-3 | 117 |
| 1.13 x 0.53 (28.6 x 13.5) | Vinyl Cloth | White | DM | PDL-4674-1 | 117 |
| 1.18 x 0.37 (30.0 x 9.5) | TEDLAR | White | DM | PDL-4565-2 | 117 |
| 1.25 x 0.25 (31.8 x 6.4) | Polyester | White | TT | TTC9Y-10 | 42 |
| 1.25 x 0.38 (31.8 x 9.5) | Destructible Paper | White | DM | PDL-370 | 118 |
| 1.25 x 0.38 (31.8 x 9.5) | Destructible Paper | White | DM | PDL-70 | 118 |
| 1.25 x 0.38 (31.8 x 9.5) | Polyester | White | DM | PDL-131 | 118 |
| 1.25 x 0.38 (31.8 x 9.5) | Polyester | White | DM | PDL-71 | 118 |
| 1.25 x 0.38 (31.8 x 9.5) | Polyester | White | L | PLL-34-Y2-10 | 73 |
| 1.25 x 0.38 (31.8 x 9.5) | Polyester | White | TT | TTC10Y-10 | 42 |
| 1.25 x 0.38 (31.8 x 9.5) | Polyester | White / Red | DM | PDL-5712-2 | 118 |
| 1.25 x 0.38 (31.8 x 9.5) | Polyester | Yellow | L | PLL-34-Y2Y-10 | 73 |
| 1.25 x 0.38 (31.8 x 9.5) | Removable Polyolefin | White | L | PLL-34-POR-10 | 73 |

* DM = Dot-Matrix, IJ = Ink Jet, L = Laser, TT = Thermal Transfer
 * TEDLAR is a registered trademark of E.I DuPont Co.

Blank Labels by Size (cont.)

| Label Size Width x Length In. (mm) | Material | Color | Print Method* | Part Number | Page No. |
|---|--------------------------|--------|------------------|----------------|-------------|
| 1.25 x 0.38 (31.8 x 9.5) | TEDLAR ^ | Gray | DM | PDL-129 | 118 |
| 1.25 x 0.38 (31.8 x 9.5) | TEDLAR | Silver | DM | PDL-26 | 118 |
| 1.25 x 0.38 (31.8 x 9.5) | TEDLAR | White | DM | PDL-128 | 118 |
| 1.25 x 0.38 (31.8 x 9.5) | TEDLAR | White | DM | PDL-128-10 | 118 |
| 1.25 x 0.38 (31.8 x 9.5) | TEDLAR | White | DM | PDL-25 | 118 |
| 1.25 x 0.38 (31.8 x 9.5) | TEDLAR | White | DM | PDL-25-10 | 118 |
| 1.25 x 0.38 (31.8 x 9.5) | TEDLAR | White | TT | TTC10T-10 | 42 |
| 1.25 x 0.38 (31.8 x 9.5) | TEDLAR | Yellow | DM | PDL-127 | 118 |
| 1.25 x 0.38 (31.8 x 9.5) | TEDLAR | Yellow | DM | PDL-24 | 118 |
| 1.25 x 0.38 (31.8 x 9.5) | Vinyl | White | DM | PDL-132 | 118 |
| 1.25 x 0.38 (31.8 x 9.5) | Vinyl | White | DM | PDL-132-10 | 118 |
| 1.25 x 0.38 (31.8 x 9.5) | Vinyl Cloth | White | DM | PDL-130 | 118 |
| 1.25 x 0.38 (31.8 x 9.5) | Vinyl Cloth | White | DM | PDL-69 | 118 |
| 1.38 x 0.19 (34.9 x 4.8) | Polyester | Clear | TT | TTC-MJ-5 | 42 |
| 1.38 x 0.19 (34.9 x 4.8) | Polyolefin | White | IJ | JL412PO-1 | 56 |
| 1.38 x 0.28 (34.9 x 7.1) | Polyester | Clear | DM | PDL-407-1 | 118 |
| 1.38 x 0.28 (34.9 x 7.1) | Polyester | White | DM | PDL-409-1 | 118 |
| 1.40 x 0.25 (35.6 x 6.4) | Polyester | Silver | L | PEL-3-Y1-5 | 77 |
| 1.40 x 0.25 (35.6 x 6.4) | Polyester | White | L | PEL-3-Y2-5 | 77 |
| 1.40 x 0.25 (35.6 x 6.4) | Tamp. Evid. Polyester | Silver | L | PEL-3-Y1C-5 | 77 |
| 1.44 x 0.50 (36.5 x 12.7) | Polyester | White | IJ | JL33Y-5 | 56 |
| 1.44 x 0.50 (36.5 x 12.7) | Polyolefin | White | IJ | JL33PO-2.5 | 56 |
| 1.44 x 0.50 (36.5 x 12.7) | Vinyl Cloth | White | IJ | JL33C-5 | 56 |
| 1.44 x 0.80 (36.5 x 20.3) | Vinyl Cloth | White | IJ | JL900C-2.5 | 56 |
| 1.50 x 0.25 (38.1 x 6.4) | Polyester | Silver | DM | PDL-7542-10 | 118 |
| 1.50 x 0.25 (38.1 x 6.4) | Polyester | White | DM | PDL-358 | 118 |
| 1.50 x 0.25 (38.1 x 6.4) | Polyester | White | L | PLL-14-Y2-10 | 73 |
| 1.50 x 0.25 (38.1 x 6.4) | Polyester | White | L | PLL-14-Y2-5 | 73 |
| 1.50 x 0.25 (38.1 x 6.4) | Polyester | White | TT | TTC11Y-10 | 42 |
| 1.50 x 0.25 (38.1 x 6.4) | Polyester | Yellow | L | PLL-14-Y2Y-5 | 73 |
| 1.50 x 0.25 (38.1 x 6.4) | Polyimide | Amber | DM | PDL-357 | 118 |
| 1.50 x 0.25 (38.1 x 6.4) | Polyolefin | White | L | PLL-14-PO-5 | 73 |
| 1.50 x 0.25 (38.1 x 6.4) | Removable Polyolefin | White | L | PLL-14-POR-5 | 73 |
| 1.50 x 0.25 (38.1 x 6.4) With Vertical Perforation | Polyester | White | DM | PDL-87 | 118 |
| 1.50 x 0.25 (38.1 x 6.4) With Vertical Perforation | Polyester | White | DM | PDL-87-10 | 118 |
| 1.50 x 0.25 (38.1 x 6.4) With Vertical Perforation | Removable Paper | White | DM | PDL-359-10 | 118 |
| 1.50 x 0.25 (38.1 x 6.4) With Vertical Perforation | Removable Paper | White | DM | PDL-40 | 118 |
| 1.50 x 0.25 (38.1 x 6.4) With Vertical Perforation | Removable Paper | White | DM | PDL-40-10 | 118 |
| 1.50 x 0.25 (38.1 x 6.4) With Vertical Perforation | TEDLAR | White | DM | PDL-86 | 118 |
| 1.50 x 0.25 (38.1 x 6.4) With Vertical Perforation | Vinyl | White | DM | PDL-629 | 118 |
| 1.50 x 0.25 (38.1 x 6.4) With Vertical Perforation | Vinyl Cloth | White | DM | PDL-360-10 | 118 |
| 1.50 x 0.25 (38.1 x 6.4) With Vertical Perforation | Vinyl Cloth | White | DM | PDL-41 | 118 |
| 1.50 x 0.25 (38.1 x 6.4) With Vertical Perforation | Vinyl Cloth | White | DM | PDL-41-1 | 118 |
| 1.50 x 0.25 (38.1 x 6.4) With Vertical Perforation | Vinyl Cloth | White | DM | PDL-41-10 | 118 |

| Label Size Width x Length In. (mm) | Material | Color | Print Method* | Part Number | Page No. |
|--|-------------------------|----------------|------------------|----------------|-------------|
| 1.50 x 0.33 (38.1 x 8.5) | Polyester | Matte Clear | L | PEL-7-Y3M-5 | 77 |
| 1.50 x 0.33 (38.1 x 8.5) | Polyester | Silver | L | PEL-7-Y1-5 | 77 |
| 1.50 x 0.33 (38.1 x 8.5) | Polyester | White | L | PEL-7-Y2-5 | 77 |
| 1.50 x 0.33 (38.1 x 8.5) | Polyester | Yellow | L | PEL-7-Y2Y-5 | 77 |
| 1.50 x 0.50 (38.1 x 12.7) | Polyester | Silver | L | PEL-12-Y1-2.5 | 77 |
| 1.50 x 0.50 (38.1 x 12.7) | Polyester | White | L | PEL-12-Y2-2.5 | 77 |
| 1.50 x 0.50 (38.1 x 12.7) | Polyester | White | TT | TTC12Y-10 | 42 |
| 1.50 x 0.50 (38.1 x 12.7) | Polyester | Yellow | L | PEL-12-Y2Y-2.5 | 77 |
| 1.50 x 0.75 (38.1 x 19.1) | Destructible Paper | White | DM | PDL-73 | 119 |
| 1.50 x 0.75 (38.1 x 19.1) | Destructible Paper | White | DM | PDL-73-10 | 119 |
| 1.50 x 0.75 (38.1 x 19.1) | Polyester | Silver | DM | PDL-29 | 119 |
| 1.50 x 0.75 (38.1 x 19.1) | Polyester | Silver | DM | PDL-29-1 | 119 |
| 1.50 x 0.75 (38.1 x 19.1) | Polyester | Silver | DM | PDL-29-10 | 119 |
| 1.50 x 0.75 (38.1 x 19.1) | Polyester | Silver | L | PLL-35-Y2S-2.5 | 73 |
| 1.50 x 0.75 (38.1 x 19.1) | Polyester | Silver | TT | TTC13YS-10 | 42 |
| 1.50 x 0.75 (38.1 x 19.1) | Polyester | White | DM | PDL-231 | 119 |
| 1.50 x 0.75 (38.1 x 19.1) | Polyester | White | DM | PDL-231-10 | 119 |
| 1.50 x 0.75 (38.1 x 19.1) | Polyester | White | TT | TTC13Y-10 | 42 |
| 1.50 x 0.75 (38.1 x 19.1) | Polyolefin | White | L | PLL-35-PO-2.5 | 73 |
| 1.50 x 0.75 (38.1 x 19.1) | Removable Polyolefin | White | L | PLL-35-POR-2.5 | 73 |
| 1.50 x 0.75 (38.1 x 19.1) | TEDLAR | White | DM | PDL-27 | 119 |
| 1.50 x 0.75 (38.1 x 19.1) | TEDLAR | White | DM | PDL-27-10 | 119 |
| 1.50 x 0.75 (38.1 x 19.1) | TEDLAR | Yellow | DM | PDL-28 | 119 |
| 1.50 x 0.75 (38.1 x 19.1) | Vinyl Cloth | White | DM | PDL-72 | 119 |
| 1.50 x 0.81 (38.1 x 20.6) | Polyester | White | TT | TTC14Y-2.5 | 42 |
| 1.50 x 0.90 (38.1 x 22.9) | Vinyl Cloth | White | DM | PDL-298 | 119 |
| 1.50 x 0.90 (38.1 x 22.9) | Vinyl Cloth | Yellow | DM | PDL-297 | 119 |
| 1.50 x 1.00 (38.1 x 25.4) | Paper | White | TT | TTC15P-2.5 | 42 |
| 1.50 x 1.00 (38.1 x 25.4) | Polyester | White | TT | TTC15Y-2.5 | 42 |
| 1.50 x 1.13 (38.1 x 28.6) | Polyester | White | TT | TTC16Y-2.5 | 42 |
| 1.63 x 0.38 (41.3 x 9.5) | Polyester | Silver | DM | PDL-7572-10R | 119 |
| 1.63 x 0.38 (41.3 x 9.5) | Polyester | Silver | DM | PDL-7572-1R | 119 |
| 1.63 x 1.25 (41.3 x 31.8) | Polyester | White | TT | TTC17Y-2.5 | 42 |
| 1.80 x 0.38 (45.7 x 9.5) | Polyester | White | TT | TTC-EFPL-1 | 42 |
| 1.80 x 0.38 (45.7 x 9.5) | Polyolefin | Blue | DM/L | EFPL-BU-1 | 100 |
| 1.80 x 0.38 (45.7 x 9.5) | Polyolefin | Gray | DM/L | EFPL-IG-1 | 100 |
| 1.80 x 0.38 (45.7 x 9.5) | Polyolefin | Green | DM/L | EFPL-GR-1 | 100 |
| 1.80 x 0.38 (45.7 x 9.5) | Polyolefin | Ivory | DM/L | EFPL-EI-1 | 100 |
| 1.80 x 0.38 (45.7 x 9.5) | Polyolefin | Orange | DM/L | EFPL-OR-1 | 100 |
| 1.80 x 0.38 (45.7 x 9.5) | Polyolefin | Red | DM/L | EFPL-RD-1 | 100 |
| 1.80 x 0.38 (45.7 x 9.5) | Polyolefin | Violet | DM/L | EFPL-VL-1 | 100 |
| 1.80 x 0.38 (45.7 x 9.5) | Polyolefin | White | DM/L | EFPL-1 | 100 |
| 1.80 x 0.38 (45.7 x 9.5) | Polyolefin | Yellow | DM/L | EFPL-YL-1 | 100 |
| 1.80 x 0.38 (45.7 x 9.5) | Polyolefin | White | IJ | JLEFPS-1 | 56 |
| 1.80 x 0.38 (45.7 x 9.5) | Semi-Rigid Vinyl | White | DM/L | EFPT-1 | 69 |
| 1.88 x 0.25 (47.6 x 6.4) | Polyester | White | L | PLL-15-Y2-5 | 73 |
| 1.88 x 0.25 (47.6 x 6.4) | Polyester | White | L | PLL-15-Y2-10 | 73 |
| 1.88 x 0.25 (47.6 x 6.4) | Polyester | Yellow | L | PLL-15-Y2Y-5 | 73 |
| 1.88 x 0.38 (47.6 x 9.5) | Polyester | White | L | PLL-16-Y2-2.5 | 73 |
| 1.88 x 0.38 (47.6 x 9.5) | Polyester | White | L | PLL-16-Y2-5 | 73 |

* DM = Dot-Matrix, IJ = Ink Jet, L = Laser, TT = Thermal Transfer
^TEDLAR is a registered trademark of E.I. DuPont Co.

Blank Labels by Size (cont.)

| Label Size Width x Length In. (mm) | Material | Color | Print Method* | Part Number | Page No. |
|--|--------------------------|--------|------------------|----------------|-------------|
| 1.88 x 0.38 (47.6 x 9.5) | Polyester | Yellow | L | PLL-16-Y2Y-2.5 | 73 |
| 1.88 x 0.38 (47.6 x 9.5) | Polyester | Yellow | L | PLL-16-Y2Y-5 | 73 |
| 1.88 x 0.38 (47.6 x 9.5) | Polyolefin | White | L | PLL-16-PO-2.5 | 73 |
| 1.88 x 0.83 (47.6 x 21.2) | Polyester | White | L | PLL-17-Y2-1 | 73 |
| 1.88 x 0.83 (47.6 x 21.2) | Polyester | White | L | PLL-17-Y2-2.5 | 73 |
| 1.88 x 0.83 (47.6 x 21.2) | Polyester | Yellow | L | PLL-17-Y2Y-2.5 | 73 |
| 1.88 x 0.83 (47.6 x 21.2) | Polyolefin | White | L | PLL-17-PO-2.5 | 73 |
| 1.88 x 1.33 (47.6 x 33.8) | Polyester | White | L | PLL-18-Y2-1 | 74 |
| 1.88 x 1.33 (47.6 x 33.8) | Polyester | White | L | PLL-18-Y2-1.5 | 74 |
| 1.88 x 1.33 (47.6 x 33.8) | Polyester | Yellow | L | PLL-18-Y2Y-1 | 74 |
| 1.88 x 1.33 (47.6 x 33.8) | Polyester | Yellow | L | PLL-18-Y2Y-1.5 | 74 |
| 1.88 x 1.33 (47.6 x 33.8) | Polyolefin | White | IJ | JL18PO-1 | 56 |
| 1.95 x 0.40 (49.5 x 10.2) | Semi-Rigid Vinyl | White | DM | PDL-408-TL | 119 |
| 2.00 x 0.25 (50.8 x 6.4) | Polyester | White | TT | TTC18Y-2.5 | 42 |
| 2.00 x 0.33 (50.8 x 8.5) | Polyester | Silver | L | PEL-8-Y1-2.5 | 77 |
| 2.00 x 0.33 (50.8 x 8.5) | Polyester | White | L | PEL-8-Y2-2.5 | 77 |
| 2.00 x 0.33 (50.8 x 8.5) | Tamp. Evid. Polyester | Silver | L | PEL-8-Y1C-2.5 | 77 |
| 2.00 x 0.38 (50.8 x 9.5) | Destructible Paper | White | DM | PDL-112 | 119 |
| 2.00 x 0.38 (50.8 x 9.5) | Destructible Paper | White | DM | PDL-78 | 119 |
| 2.00 x 0.38 (50.8 x 9.5) | Polyester | Clear | DM | PDL110G5 | 119 |
| 2.00 x 0.38 (50.8 x 9.5) | Polyester | Silver | DM | PDL-7517 | 119 |
| 2.00 x 0.38 (50.8 x 9.5) | Polyester | White | DM | PDL-111 | 119 |
| 2.00 x 0.38 (50.8 x 9.5) | Polyester | White | DM | PDL-111-1 | 119 |
| 2.00 x 0.38 (50.8 x 9.5) | Polyester | White | DM | PDL-77 | 119 |
| 2.00 x 0.38 (50.8 x 9.5) | Polyimide | Amber | DM | PDL-237 | 119 |
| 2.00 x 0.38 (50.8 x 9.5) | TEDLAR * | White | DM | PDL-110 | 119 |
| 2.00 x 0.38 (50.8 x 9.5) | TEDLAR | White | DM | PDL-110-1 | 119 |
| 2.00 x 0.38 (50.8 x 9.5) | TEDLAR | White | DM | PDL-76 | 119 |
| 2.00 x 0.38 (50.8 x 9.5) | Vinyl | White | DM | PDL-113 | 119 |
| 2.00 x 0.38 (50.8 x 9.5) | Vinyl Cloth | White | DM | PDL-114 | 119 |
| 2.00 x 0.38 (50.8 x 9.5) | Vinyl Cloth | White | DM | PDL-32 | 119 |
| 2.00 x 0.38 (50.8 x 9.5) | Vinyl Cloth | White | DM | PDL-32-1 | 119 |
| 2.00 x 0.38 (50.8 x 9.5) | Vinyl Cloth | White | DM | PDL-32-10 | 119 |
| 2.00 x 0.50 (50.8 x 12.7) | Polyester | Silver | L | PEL-13-Y1-2.5 | 77 |
| 2.00 x 0.50 (50.8 x 12.7) | Polyester | White | L | PEL-13-Y2-2.5 | 77 |
| 2.00 x 0.50 (50.8 x 12.7) | Polyester | White | TT | TTC19Y-2.5 | 42 |
| 2.00 x 0.83 (50.8 x 21.2) | Polyester | Silver | L | PEL-14-Y1-1 | 77 |
| 2.00 x 0.83 (50.8 x 21.2) | Polyester | White | L | PEL-14-Y2-1 | 77 |
| 2.00 x 0.90 (50.8 x 22.9) | Destructible Paper | White | DM | PDL-300 | 119 |
| 2.00 x 0.90 (50.8 x 22.9) | Polyester | Silver | DM | PDL-302 | 119 |
| 2.00 x 0.90 (50.8 x 22.9) | Polyester | White | DM | PDL-301 | 119 |
| 2.00 x 0.90 (50.8 x 22.9) | Polyolefin | White | IJ | JL41PO-0.5 | 56 |
| 2.00 x 0.90 (50.8 x 22.9) | Removable Paper | White | DM | PDL-299 | 119 |
| 2.00 x 1.00 (50.8 x 25.4) | Paper | White | TT | TTC20P-2.5 | 42 |
| 2.00 x 1.00 (50.8 x 25.4) | Polyester | Clear | TT | TTC20YC-2.5 | 42 |
| 2.00 x 1.00 (50.8 x 25.4) | Polyester | Silver | L | PEL-15-Y1-1 | 77 |
| 2.00 x 1.00 (50.8 x 25.4) | Polyester | Silver | TT | TTC20YS-2.5 | 42 |
| 2.00 x 1.00 (50.8 x 25.4) | Polyester | White | L | PEL-15-Y2-1 | 77 |
| 2.00 x 1.00 (50.8 x 25.4) | Polyester | White | TT | TTC20Y-2.5 | 42 |
| 2.00 x 1.00 (50.8 x 25.4) | Polyester | Yellow | L | PEL-15-Y2Y-1 | 77 |

| Label Size Width x Length In. (mm) | Material | Color | Print Method* | Part Number | Page No. |
|--|--------------------------|--------|------------------|----------------|-------------|
| 2.00 x 1.00 (50.8 x 25.4) | Tamp. Evid. Polyester | Silver | L | PEL-15-Y1C-1 | 77 |
| 2.00 x 1.00 (50.8 x 25.4) | Tamp. Evid. Polyester | Silver | TT | TTC20YST-2.5 | 42 |
| 2.00 x 1.25 (50.8 x 31.8) | Aluminum | Silver | DM | PDL-148 | 119 |
| 2.00 x 1.25 (50.8 x 31.8) | Destructible Paper | White | DM | PDL-149 | 119 |
| 2.00 x 1.25 (50.8 x 31.8) | Paper | White | TT | TTC21P-2.5 | 42 |
| 2.00 x 1.25 (50.8 x 31.8) | Polyester | Silver | DM | PDL-145 | 119 |
| 2.00 x 1.25 (50.8 x 31.8) | Polyester | White | DM | PDL-150 | 119 |
| 2.00 x 1.25 (50.8 x 31.8) | Vinyl | White | DM | PDL-146 | 119 |
| 2.00 x 1.25 (50.8 x 31.8) | Vinyl Cloth | White | DM | PDL-147 | 119 |
| 2.00 x 1.44 (50.8 x 36.5) | Destructible Paper | White | DM | PDL-304 | 120 |
| 2.00 x 1.44 (50.8 x 36.5) | Polyester | Silver | DM | PDL-306 | 120 |
| 2.00 x 1.44 (50.8 x 36.5) | Polyester | White | DM | PDL-305 | 120 |
| 2.00 x 1.44 (50.8 x 36.5) | Polyester | White | DM | PDL-305-10 | 120 |
| 2.00 x 1.44 (50.8 x 36.5) | Removable Paper | White | DM | PDL-303 | 120 |
| 2.50 x 0.94 (63.5 x 23.8) | Litho Paper | White | DM | PL2515-1 | 103 |
| 2.50 x 0.94 (63.5 x 23.8) | Litho Paper | White | DM | PL2515-2 | 103 |
| 2.50 x 0.94 (63.5 x 23.8) | Litho Paper | White | DM | PL2515-3 | 103 |
| 2.50 x 0.94 (63.5 x 23.8) | Litho Paper | White | DM | PL2515-4 | 103 |
| 2.50 x 0.94 (63.5 x 23.8) | Litho Paper | White | DM | PL2515-5 | 103 |
| 2.50 x 1.00 (63.5 x 25.4) | Polyester | Silver | L | PLL-36-Y2S-1 | 74 |
| 2.50 x 1.00 (63.5 x 25.4) | Polyester | White | L | PLL-36-Y2-1 | 74 |
| 2.50 x 1.00 (63.5 x 25.4) | Polyolefin | White | L | PLL-36-PO-1 | 74 |
| 2.50 x 1.00 (63.5 x 25.4) | Removable Polyolefin | White | L | PLL-36-POR-1 | 74 |
| 2.50 x 1.33 (63.5 x 33.9) | Polyester | Silver | L | PEL-16-Y1-0.5 | 77 |
| 2.50 x 1.33 (63.5 x 33.9) | Polyester | White | L | PEL-16-Y2-0.5 | 77 |
| 2.50 x 1.33 (63.5 x 33.9) | Tamp. Evid. Polyester | Silver | L | PEL-16-Y1C-0.5 | 77 |
| 2.50 x 4.25 (63.5 x 108.0) | TEDLAR | White | DM | PDL-7557-1 | 120 |
| 2.75 x 0.44 (69.9 x 11.1) | Litho Paper | White | DM | PL2757-1 | 103 |
| 2.75 x 0.44 (69.9 x 11.1) | Litho Paper | White | DM | PL2757-4 | 103 |
| 2.75 x 0.94 (69.9 x 23.8) | Litho Paper | White | DM | PL27515-1 | 103 |
| 2.75 x 0.94 (69.9 x 23.8) | Litho Paper | White | DM | PL27515-3 | 103 |
| 2.75 x 0.94 (69.9 x 23.8) | Litho Paper | White | DM | PL27515-4 | 103 |
| 2.75 x 1.25 (69.9 x 31.8) | Paper | White | TT | TTC22P-2.5 | 43 |
| 2.75 x 1.25 (69.9 x 31.8) | Polyester | Silver | TT | TTC22YS-2.5 | 43 |
| 2.75 x 1.25 (69.9 x 31.8) | Polyester | White | TT | TTC22Y-2.5 | 43 |
| 2.75 x 1.44 (69.9 x 36.5) | Litho Paper | White | DM | PL27517-1 | 103 |
| 2.75 x 1.94 (69.9 x 49.2) | Litho Paper | White | DM | PL275115-1 | 103 |
| 2.75 x 2.75 (69.9 x 69.9) | Destructible Paper | White | IJ | JL903P-0.5 | 56 |
| 2.80 x 1.00 (71.1 x 25.4) | Destructible Paper | White | DM | PDL-163 | 120 |
| 2.80 x 1.00 (71.1 x 25.4) | Vinyl Cloth | White | DM | PDL-164 | 120 |
| 2.80 x 1.50 (71.1 x 38.1) | Destructible Paper | White | DM | PDL-165 | 120 |
| 2.80 x 1.50 (71.1 x 38.1) | Vinyl Cloth | White | DM | PDL-166 | 120 |
| 2.83 x 1.00 (72.0 x 25.4) | Litho Paper | White | L | LL2561-100 | 75 |
| 2.83 x 1.00 (72.0 x 25.4) | Litho Paper | White | L | LL2561-100G | 75 |
| 2.83 x 1.00 (72.0 x 25.4) | Litho Paper | White | L | LL2561-250 | 75 |
| 2.83 x 1.00 (72.0 x 25.4) | Litho Paper | White | L | LL2561-500 | 75 |

* DM = Dot-Matrix, IJ = Ink Jet, L = Laser, TT = Thermal Transfer
 * TEDLAR is a registered trademark of E.I. DuPont Co.

Blank Labels by Size (cont.)

| Label Size Width x Length In. (mm) | Material | Color | Print Method* | Part Number | Page No. |
|--|-----------------------|--------|------------------|----------------|-------------|
| 2.83 x 1.00 (72.0 x 25.4) | Polyester | White | L | PLL-26-Y2-1 | 74 |
| 2.83 x 1.38 (72.0 x 34.9) | Litho Paper | White | L | LL256138-100 | 75 |
| 2.83 x 1.38 (72.0 x 34.9) | Polyester | White | L | PLL-27-Y2-1 | 74 |
| 2.83 x 1.50 (72.0 x 38.1) | Litho Paper | White | L | LL25615-100G | 75 |
| 2.83 x 1.50 (72.0 x 38.1) | Polyester | White | L | PLL-28-Y2-1 | 74 |
| 2.90 x 0.30 (73.7 x 7.6) | Polyester | White | TT | TTC-EFPL10-1 | 43 |
| 2.90 x 0.30 (73.7 x 7.6) | Polyolefin | Blue | DM/L | EFPL10-BU-1 | 100 |
| 2.90 x 0.30 (73.7 x 7.6) | Polyolefin | Gray | DM/L | EFPL10-IG-1 | 100 |
| 2.90 x 0.30 (73.7 x 7.6) | Polyolefin | Green | DM/L | EFPL10-GR-1 | 100 |
| 2.90 x 0.30 (73.7 x 7.6) | Polyolefin | Ivory | DM/L | EFPL10-EI-1 | 100 |
| 2.90 x 0.30 (73.7 x 7.6) | Polyolefin | Orange | DM/L | EFPL10-OR-1 | 100 |
| 2.90 x 0.30 (73.7 x 7.6) | Polyolefin | Red | DM/L | EFPL10-RD-1 | 100 |
| 2.90 x 0.30 (73.7 x 7.6) | Polyolefin | Violet | DM/L | EFPL10-VL-1 | 100 |
| 2.90 x 0.30 (73.7 x 7.6) | Polyolefin | White | DM/L | EFPL10-1 | 100 |
| 2.90 x 0.30 (73.7 x 7.6) | Polyolefin | Yellow | DM/L | EFPL10-YL-1 | 100 |
| 2.90 x 0.30 (73.7 x 7.6) | Semi-Rigid Vinyl | White | DM/L | EFPT10-1 | 69 |
| 2.90 x 0.94 (73.7 x 23.8) | Litho Paper | White | DM | PL2915-4 | 103 |
| 3.00 x 0.25 (76.2 x 6.4) | Polyester | White | TT | TTC23Y-2.5 | 43 |
| 3.00 x 0.33 (76.2 x 8.5) | Semi-Rigid Vinyl | White | DM | PDL-410-TL | 120 |
| 3.00 x 0.38 (76.2 x 9.5) | Destructible Paper | White | DM | PDL-81 | 120 |
| 3.00 x 0.38 (76.2 x 9.5) | Polyester | White | DM | PDL-80 | 120 |
| 3.00 x 0.38 (76.2 x 9.5) | Polyester | White | L | PLL-19-Y2-1 | 74 |
| 3.00 x 0.38 (76.2 x 9.5) | Polyester | White | L | PLL-19-Y2-2.5 | 74 |
| 3.00 x 0.38 (76.2 x 9.5) | Polyester | Yellow | L | PLL-19-Y2Y-1 | 74 |
| 3.00 x 0.38 (76.2 x 9.5) | Polyester | Yellow | L | PLL-19-Y2Y-2.5 | 74 |
| 3.00 x 0.38 (76.2 x 9.5) | Polyimide | Amber | DM | PDL-232 | 120 |
| 3.00 x 0.38 (76.2 x 9.5) | Removable Polyolefin | White | L | PLL-19-POR-2.5 | 74 |
| 3.00 x 0.38 (76.2 x 9.5) | TEDLAR * | White | DM | PDL-79 | 120 |
| 3.00 x 0.38 (76.2 x 9.5) | Vinyl Cloth | White | DM | PDL-33 | 120 |
| 3.00 x 0.90 (76.2 x 22.9) | Destructible Paper | White | DM | PDL-310 | 120 |
| 3.00 x 0.90 (76.2 x 22.9) | Destructible Paper | White | TT | TTC46P-5 | 43 |
| 3.00 x 0.90 (76.2 x 22.9) | Polyester | Silver | DM | PDL-312 | 120 |
| 3.00 x 0.90 (76.2 x 22.9) | Polyester | White | DM | PDL-311 | 120 |
| 3.00 x 0.90 (76.2 x 22.9) | Removable Paper | White | DM | PDL-309 | 120 |
| 3.00 x 0.90 (76.2 x 22.9) | Vinyl Cloth | White | DM | PDL-308 | 120 |
| 3.00 x 0.90 (76.2 x 22.9) | Vinyl Cloth | Yellow | DM | PDL-307 | 120 |
| 3.00 x 0.94 (76.2 x 23.8) | Litho Paper | White | DM | PL315-1 | 103 |
| 3.00 x 0.94 (76.2 x 23.8) | Litho Paper | White | DM | PL315-4 | 103 |
| 3.00 x 1.00 (76.2 x 25.4) | Paper | White | TT | TTC24P-2.5 | 43 |
| 3.00 x 1.00 (76.2 x 25.4) | Polyester | Clear | TT | TTC24YC-2.5 | 43 |
| 3.00 x 1.00 (76.2 x 25.4) | Polyester | Silver | TT | TTC24YS-2.5 | 43 |
| 3.00 x 1.00 (76.2 x 25.4) | Polyester | White | TT | TTC24Y-2.5 | 43 |
| 3.00 x 1.00 (76.2 x 25.4) | Tamp. Evid. Polyester | Silver | TT | TTC24YST-2.5 | 43 |
| 3.00 x 1.44 (76.2 x 36.5) | Destructible Paper | White | DM | PDL-314 | 120 |
| 3.00 x 1.44 (76.2 x 36.5) | Polyester | Silver | DM | PDL-316 | 120 |
| 3.00 x 1.44 (76.2 x 36.5) | Polyester | White | DM | PDL-315 | 120 |
| 3.00 x 1.44 (76.2 x 36.5) | Removable Paper | White | DM | PDL-313 | 120 |

| Label Size Width x Length In. (mm) | Material | Color | Print Method* | Part Number | Page No. |
|--|-----------------------|--------|------------------|----------------|-------------|
| 3.00 x 1.90 (76.2 x 48.3) | Destructible Paper | White | DM | PDL-318 | 120 |
| 3.00 x 1.90 (76.2 x 48.3) | Polyester | Silver | DM | PDL-320 | 120 |
| 3.00 x 1.90 (76.2 x 48.3) | Polyester | White | DM | PDL-319 | 120 |
| 3.00 x 1.90 (76.2 x 48.3) | Removable Paper | White | DM | PDL-317 | 120 |
| 3.00 x 2.00 (76.2 x 50.8) | Aluminum | Silver | DM | PDL-143 | 120 |
| 3.00 x 2.00 (76.2 x 50.8) | Destructible Paper | White | DM | PDL-141 | 120 |
| 3.00 x 2.00 (76.2 x 50.8) | Paper | White | TT | TTC25P-1 | 43 |
| 3.00 x 2.00 (76.2 x 50.8) | Polyester | Clear | TT | TTC25YC-1 | 43 |
| 3.00 x 2.00 (76.2 x 50.8) | Polyester | Silver | DM | PDL-139 | 120 |
| 3.00 x 2.00 (76.2 x 50.8) | Polyester | Silver | TT | TTC25YS-1 | 43 |
| 3.00 x 2.00 (76.2 x 50.8) | Polyester | White | DM | PDL-144 | 120 |
| 3.00 x 2.00 (76.2 x 50.8) | Polyester | White | TT | TTC25Y-1 | 43 |
| 3.00 x 2.00 (76.2 x 50.8) | Tamp. Evid. Polyester | Silver | TT | TTC25YST-1 | 43 |
| 3.00 x 2.00 (76.2 x 50.8) | Vinyl | White | DM | PDL-140 | 120 |
| 3.00 x 2.00 (76.2 x 50.8) | Vinyl Cloth | White | DM | PDL-142 | 120 |
| 3.00 x 5.00 (76.2 x 127.0) | Paper | White | TT | TTC26P-1 | 43 |
| 3.20 x 0.90 (81.3 x 22.9) | Litho Paper | White | DM | PL3278-4 | 104 |
| 3.20 x 0.90 (81.3 x 22.9) | Litho Paper | White | DM | PL329-4 | 104 |
| 3.20 x 0.94 (81.3 x 23.8) | Litho Paper | White | DM | PL3215-4 | 103 |
| 3.25 x 0.31 (82.6 x 7.92) | Polyester | White | TT | TTC27Y-10 | 43 |
| 3.25 x 0.50 (82.6 x 12.7) | Polyester | White | TT | TTC28Y-10 | 43 |
| 3.25 x 0.63 (82.6 x 15.9) | Polyester | White | TT | TTC29Y-5 | 43 |
| 3.25 x 0.81 (82.6 x 20.6) | Polyester | White | TT | TTC30Y-2.5 | 43 |
| 3.25 x 1.25 (82.6 x 31.8) | Aluminum | Silver | DM | PDL-154 | 120 |
| 3.25 x 1.25 (82.6 x 31.8) | Destructible Paper | White | DM | PDL-155 | 120 |
| 3.25 x 1.25 (82.6 x 31.8) | Polyester | Silver | DM | PDL-151 | 120 |
| 3.25 x 1.25 (82.6 x 31.8) | Polyester | White | DM | PDL-156 | 120 |
| 3.25 x 1.25 (82.6 x 31.8) | Vinyl | White | DM | PDL-152 | 120 |
| 3.25 x 1.25 (82.6 x 31.8) | Vinyl Cloth | White | DM | PDL-153 | 120 |
| 3.30 x 0.94 (83.8 x 23.8) | Litho Paper | White | DM | PL3315-4 | 103 |
| 3.50 x 0.44 (88.9 x 11.1) | Litho Paper | White | DM | PL357-1 | 103 |
| 3.50 x 0.44 (88.9 x 11.1) | Litho Paper | White | DM | PL357-2 | 103 |
| 3.50 x 0.44 (88.9 x 11.1) | Litho Paper | White | DM | PL357-3 | 103 |
| 3.50 x 0.64 (88.9 x 16.1) | Litho Paper | Blue | DM | PL3510-1FB | 104 |
| 3.50 x 0.64 (88.9 x 16.1) | Litho Paper | Brown | DM | PL3510-1FBR | 104 |
| 3.50 x 0.64 (88.9 x 16.1) | Litho Paper | Green | DM | PL3510-1FG | 104 |
| 3.50 x 0.64 (88.9 x 16.1) | Litho Paper | Orange | DM | PL3510-1FO | 104 |
| 3.50 x 0.64 (88.9 x 16.1) | Litho Paper | Pink | DM | PL3510-1FP | 104 |
| 3.50 x 0.64 (88.9 x 16.1) | Litho Paper | Purple | DM | PL3510-1FPU | 104 |
| 3.50 x 0.64 (88.9 x 16.1) | Litho Paper | Red | DM | PL3510-1FR | 104 |
| 3.50 x 0.64 (88.9 x 16.1) | Litho Paper | White | DM | PL3510-1F | 104 |
| 3.50 x 0.64 (88.9 x 16.1) | Litho Paper | Yellow | DM | PL3510-1FY | 104 |
| 3.50 x 0.94 (88.9 x 23.8) | Litho Paper | White | DM | PL3515-1 | 103 |
| 3.50 x 0.94 (88.9 x 23.8) | Litho Paper | White | DM | PL3515-2 | 103 |
| 3.50 x 0.94 (88.9 x 23.8) | Litho Paper | White | DM | PL3515-3 | 103 |
| 3.50 x 0.94 (88.9 x 23.8) | Litho Paper | White | DM | PL3515-4 | 103 |
| 3.50 x 0.94 (88.9 x 23.8) | Litho Paper | Blue | DM | PL3515-1TB | 104 |
| 3.50 x 0.94 (88.9 x 23.8) | Litho Paper | Green | DM | PL3515-1TG | 104 |
| 3.50 x 0.94 (88.9 x 23.8) | Litho Paper | Pink | DM | PL3515-1TP | 104 |
| 3.50 x 0.94 (88.9 x 23.8) | Litho Paper | Tan | DM | PL3515-1TT | 104 |
| 3.50 x 0.94 (88.9 x 23.8) | Litho Paper | Yellow | DM | PL3515-1TY | 104 |

* DM = Dot-Matrix, IJ = Ink Jet, L = Laser, TT = Thermal Transfer
 * TEDLAR is a registered trademark of E.I. DuPont Co.

Blank Labels by Size (cont.)

| Label Size Width x Length In. (mm) | Material | Color | Print Method* | Part Number | Page No. |
|--|--------------------------|--------|------------------|----------------|-------------|
| 3.50 x 0.94 (88.9 x 23.8) | Litho Paper | White | DM | PL3515-1TRL | 105 |
| 3.50 x 0.94 (88.9 x 23.8) | Removable Litho Paper | White | DM | PL3515-1R | 105 |
| 3.50 x 0.94 (88.9 x 23.8) | Removable Litho Paper | White | DM | PL3515-3R | 105 |
| 3.50 x 1.00 (88.9 x 25.4) | Paper | White | TT | TTC31P-1 | 43 |
| 3.50 x 1.00 (88.9 x 25.4) | Polyester | White | TT | TTC31Y-1 | 43 |
| 3.50 x 1.44 (88.9 x 36.5) | Litho Paper | White | DM | PL3517-TRL | 105 |
| 3.50 x 1.44 (88.9 x 36.5) | Litho Paper | White | DM | PL3517-1 | 103 |
| 3.50 x 1.44 (88.9 x 36.5) | Litho Paper | White | DM | PL3517-3 | 103 |
| 3.50 x 1.94 (88.9 x 49.2) | Litho Paper | White | DM | PL35115-1 | 103 |
| 3.50 x 1.94 (88.9 x 49.2) | Litho Paper | White | DM | PL35115-3 | 103 |
| 3.50 x 8.00 (88.9 x 203.2) | Paper | White | TT | TTC32P-1 | 43 |
| 3.50 x 8.00 (88.9 x 203.2) | Polyester | White | TT | TTC32Y-1 | 43 |
| 3.63 x 1.00 (92.1 x 25.4) | Destructible Paper | White | DM | PDL-159 | 121 |
| 3.63 x 1.00 (92.1 x 25.4) | Vinyl Cloth | White | DM | PDL-160 | 121 |
| 3.63 x 1.50 (92.1 x 38.1) | Destructible Paper | White | DM | PDL-161 | 121 |
| 3.63 x 1.50 (92.1 x 38.1) | Vinyl Cloth | White | DM | PDL-162 | 121 |
| 3.63 x 4.22 (92.1 x 107.1) | Paper | White | TT | TTC34P-5 | 43 |
| 3.63 x 5.79 (92.1 x 147.1) | Paper | White | TT | TTC33P-5 | 43 |
| 3.88 x 1.44 (98.4 x 36.5) | Litho Paper | White | DM | PL3817-1TRL | 105 |
| 3.88 x 1.75 (98.4 x 44.5) | Litho Paper | White | DM | PL38175-1TRL | 105 |
| 3.90 x 0.90 (99.1 x 22.9) | Vinyl Cloth | White | DM | PDL-322 | 121 |
| 3.90 x 0.90 (99.1 x 22.9) | Vinyl Cloth | Yellow | DM | PDL-321 | 121 |
| 3.90 x 1.44 (99.1 x 36.5) | Destructible Paper | White | DM | PDL-326 | 121 |
| 3.90 x 1.44 (99.1 x 36.5) | Polyester | Silver | DM | PDL-328 | 121 |
| 3.90 x 1.44 (99.1 x 36.5) | Polyester | White | DM | PDL-327 | 121 |
| 3.90 x 1.44 (99.1 x 36.5) | Removable Paper | White | DM | PDL-325 | 121 |
| 3.90 x 1.44 (99.1 x 36.5) | Vinyl Cloth | White | DM | PDL-324 | 121 |
| 3.90 x 1.44 (99.1 x 36.5) | Vinyl Cloth | Yellow | DM | PDL-323 | 121 |
| 3.90 x 2.90 (99.1 x 73.7) | Vinyl Cloth | White | DM | PDL-330 | 121 |
| 3.90 x 2.90 (99.1 x 73.7) | Vinyl Cloth | Yellow | DM | PDL-329 | 121 |
| 4.00 x 0.44 (101.6 x 11.1) | Litho Paper | White | DM | PL47-1 | 103 |
| 4.00 x 0.94 (101.6 x 23.8) | Litho Paper | Blue | DM | PL417-1TB | 104 |
| 4.00 x 0.94 (101.6 x 23.8) | Litho Paper | Green | DM | PL417-1TG | 104 |
| 4.00 x 0.94 (101.6 x 23.8) | Litho Paper | Pink | DM | PL417-1TP | 104 |
| 4.00 x 0.94 (101.6 x 23.8) | Litho Paper | Tan | DM | PL417-1TT | 104 |
| 4.00 x 0.94 (101.6 x 23.8) | Litho Paper | White | DM | PL415-1 | 103 |
| 4.00 x 0.94 (101.6 x 23.8) | Litho Paper | White | DM | PL415-2 | 103 |
| 4.00 x 0.94 (101.6 x 23.8) | Litho Paper | White | DM | PL415-3 | 103 |
| 4.00 x 0.94 (101.6 x 23.8) | Litho Paper | Yellow | DM | PL417-1TY | 104 |
| 4.00 x 0.94 (101.6 x 23.8) | Removable Litho Paper | White | DM | PL417-1R | 105 |
| 4.00 x 1.00 (101.6 x 25.4) | Paper | White | TT | TTC35P-2.5 | 43 |
| 4.00 x 1.00 (101.6 x 25.4) | Polyester | White | TT | TTC35Y-2.5 | 43 |
| 4.00 x 1.44 (101.6 x 36.5) | Litho Paper | White | DM | PL417-1 | 103 |
| 4.00 x 1.44 (101.6 x 36.5) | Litho Paper | White | DM | PL417-1TRL | 104 |
| 4.00 x 1.44 (101.6 x 36.5) | Litho Paper | White | DM | PL417-2 | 103 |
| 4.00 x 1.44 (101.6 x 36.5) | Litho Paper | White | DM | PL417-3 | 103 |
| 4.00 x 1.75 (101.6 x 44.5) | Litho Paper | White | DM | PL4175-1TRL | 105 |
| 4.00 x 1.94 (101.6 x 49.2) | Litho Paper | White | DM | PL4115-1 | 103 |
| 4.00 x 1.94 (101.6 x 49.2) | Litho Paper | White | DM | PL4115-3 | 103 |

| Label Size Width x Length In. (mm) | Material | Color | Print Method* | Part Number | Page No. |
|--|-----------------------|--------|------------------|----------------|-------------|
| 4.00 x 2.00 (101.6 x 50.8) | Paper | White | TT | TTC36P-1 | 43 |
| 4.00 x 2.00 (101.6 x 50.8) | Polyester | Silver | TT | TTC36YS-1 | 43 |
| 4.00 x 2.00 (101.6 x 50.8) | Polyester | White | TT | TTC36Y-1 | 43 |
| 4.00 x 2.44 (101.6 x 61.9) | Litho Paper | White | DM | PL427-1 | 103 |
| 4.00 x 2.94 (101.6 x 74.6) | Litho Paper | White | DM | PL4215-1 | 103 |
| 4.00 x 2.94 (101.6 x 74.6) | Litho Paper | White | DM | PL4215-3 | 103 |
| 4.00 x 3.00 (101.6 x 76.2) | Paper | White | TT | TTC37P-1 | 43 |
| 4.00 x 3.00 (101.6 x 76.2) | Polyester | White | TT | TTC37Y-1 | 43 |
| 4.00 x 4.00 (101.6 x 101.6) | Paper | White | TT | TTC38P-1 | 43 |
| 4.00 x 4.00 (101.6 x 101.6) | Polyester | White | TT | TTC38Y-1 | 43 |
| 4.00 x 5.00 (101.6 x 127.0) | Paper | White | TT | TTC39P-1 | 43 |
| 4.00 x 5.00 (101.6 x 127.0) | Polyester | White | TT | TTC39Y-1 | 43 |
| 4.00 x 6.00 (101.6 x 152.4) | Paper | White | TT | TTC40P-1 | 43 |
| 4.00 x 6.50 (101.6 x 165.1) | Paper | White | TT | TTC41P-1 | 43 |
| 4.00 x 6.50 (101.6 x 165.1) | Polyester | White | TT | TTC41Y-1 | 43 |
| 4.00 x 12.88 (101.6 x 327.0) | Paper | White | TT | TTC42P-5 | 43 |
| 4.00 x 12.88 (101.6 x 327.0) | Polyester | White | TT | TTC42Y-5 | 43 |
| 4.25 x 2.00 (108.0 x 50.8) | Litho Paper | White | L | LL4252-100G | 75 |
| 4.25 x 2.00 (108.0 x 50.8) | Litho Paper | White | L | LL425275-250 | 75 |
| 4.25 x 2.00 (108.0 x 50.8) | Polyester | White | L | PLL-29-Y2-1 | 74 |
| 4.25 x 2.94 (108.0 x 74.6) | Litho Paper | White | DM | PL425215-1 | 103 |
| 4.25 x 13.00 (108.0 x 330.2) | Litho Paper | White | L | LL42513-100G | 75 |
| 5.00 x 0.44 (127.0 x 11.1) | Litho Paper | White | DM | PL57-1 | 103 |
| 5.00 x 0.94 (127.0 x 23.8) | Litho Paper | White | DM | PL515-1 | 103 |
| 5.00 x 0.94 (127.0 x 23.8) | Litho Paper | White | DM | PL515-2 | 103 |
| 5.00 x 1.44 (127.0 x 36.5) | Litho Paper | White | DM | PL517-1 | 103 |
| 5.00 x 1.94 (127.0 x 49.2) | Litho Paper | White | DM | PL5115-1 | 103 |
| 5.00 x 2.94 (127.0 x 74.6) | Litho Paper | White | DM | PL5215-1 | 103 |
| 5.00 x 2.94 (127.0 x 74.6) | Litho Paper | White | DM | PL5215-2 | 103 |
| 5.00 x 3.94 (127.0 x 100.0) | Litho Paper | White | DM | PL5315-1 | 103 |
| 5.00 x 3.94 (127.0 x 100.0) | Litho Paper | White | DM | PL5315-2 | 103 |
| 5.00 x 4.00 (127.0 x 101.6) | Paper | White | TT | TTC43P-1 | 44 |
| 5.00 x 4.00 (127.0 x 101.6) | Polyester | White | TT | TTC43Y-1 | 44 |
| 5.75 x 2.94 (146.1 x 74.6) | Litho Paper | White | DM | PL575215-1 | 103 |
| 6.00 x 0.90 (152.4 x 22.9) | Vinyl Cloth | White | DM | PDL-332 | 121 |
| 6.00 x 0.90 (152.4 x 22.9) | Vinyl Cloth | Yellow | DM | PDL-331 | 121 |
| 6.00 x 1.44 (152.4 x 36.6) | Vinyl Cloth | White | DM | PDL-334 | 121 |
| 6.00 x 1.44 (152.4 x 36.6) | Vinyl Cloth | Yellow | DM | PDL-333 | 121 |
| 6.00 x 1.90 (152.4 x 48.3) | Vinyl Cloth | White | DM | PDL-336 | 121 |
| 6.00 x 1.90 (152.4 x 48.3) | Vinyl Cloth | Yellow | DM | PDL-335 | 121 |
| 6.00 x 2.90 (152.4 x 73.7) | Vinyl Cloth | White | DM | PDL-338 | 121 |
| 6.00 x 2.90 (152.4 x 73.7) | Vinyl Cloth | Yellow | DM | PDL-337 | 121 |
| 6.00 x 3.94 (152.4 x 100.0) | Destructible Paper | White | DM | PDL-340 | 121 |
| 6.00 x 3.94 (152.4 x 100.0) | Removable Paper | White | DM | PDL-339 | 121 |
| 6.00 x 3.98 (152.4 x 100.0) | Litho Paper | White | DM | PL6315-1 | 105 |
| 6.00 x 3.98 (152.4 x 100.0) | Litho Paper | White | DM | PL6315-2 | 105 |
| 6.00 x 3.98 (152.4 x 100.0) | Litho Paper | White | DM | PL65315-2 | 105 |
| 6.00 x 4.00 (152.4 x 101.6) | Paper | White | TT | TTC44P-1 | 44 |
| 6.00 x 4.00 (152.4 x 101.6) | Polyester | White | TT | TTC44Y-1 | 44 |
| 7.50 x 0.50 (190.5 x 12.7) | Polyester | Clear | DM | PDL-404-1 | 121 |
| 7.50 x 0.50 (190.5 x 12.7) | Polyester | Clear | DM | PDL-404-2.5 | 121 |
| 7.50 x 0.50 (190.5 x 12.7) | Polyester | White | DM | PDL-403-1 | 121 |
| 7.50 x 0.50 (190.5 x 12.7) | Polyester | Blue | DM | PDL-403-1B | 121 |

* DM = Dot-Matrix, IJ = Ink Jet, L = Laser, TT = Thermal Transfer

Blank Labels by Size (cont.)

| Label Size Width x Length In. (mm) | Material | Color | Print Method* | Part Number | Page No. |
|--|-----------------------|-------------|------------------|----------------|-------------|
| 7.50 x 0.50 (190.5 x 12.7) | Polyester | Brown | DM | PDL-403-1BR | 121 |
| 7.50 x 0.50 (190.5 x 12.7) | Polyester | Green | DM | PDL-403-1G | 121 |
| 7.50 x 0.50 (190.5 x 12.7) | Polyester | Gray | DM | PDL-403-1GR | 121 |
| 7.50 x 0.50 (190.5 x 12.7) | Polyester | Orange | DM | PDL-403-1OR | 121 |
| 7.50 x 0.50 (190.5 x 12.7) | Polyester | Purple | DM | PDL-403-1PR | 121 |
| 7.50 x 0.50 (190.5 x 12.7) | Polyester | Red | DM | PDL-403-1R | 121 |
| 7.50 x 0.50 (190.5 x 12.7) | Polyester | Yellow | DM | PDL-403-1Y | 121 |
| 7.50 x 0.50 (190.5 x 12.7) | Polyester | White | DM | PDL-403-2.5 | 121 |
| 7.75 x 0.44 (196.9 x 11.1) | Litho Paper | White | DM | PL7757-1 | 103 |
| 7.75 x 0.94 (196.9 x 23.8) | Litho Paper | White | DM | PL77515-1 | 103 |
| 7.88 x 0.50 (200.0 x 12.7) | Polyester | Clear | L | PLL-22-Y3-1 | 74 |
| 7.88 x 0.50 (200.0 x 12.7) | Polyester | White | L | PLL-22-Y2-1 | 74 |
| 7.88 x 0.50 (200.0 x 12.7) | Polyolefin | Blue | L | PLL-22-PO-1B | 74 |
| 7.88 x 0.50 (200.0 x 12.7) | Polyolefin | Brown | L | PLL-22-PO-1BR | 74 |
| 7.88 x 0.50 (200.0 x 12.7) | Polyolefin | Gray | L | PLL-22-PO-1GR | 74 |
| 7.88 x 0.50 (200.0 x 12.7) | Polyolefin | Green | L | PLL-22-PO-1G | 74 |
| 7.88 x 0.50 (200.0 x 12.7) | Polyolefin | Orange | L | PLL-22-PO-1OR | 74 |
| 7.88 x 0.50 (200.0 x 12.7) | Polyolefin | Purple | L | PLL-22-PO-1PR | 74 |
| 7.88 x 0.50 (200.0 x 12.7) | Polyolefin | Red | L | PLL-22-PO-1R | 74 |
| 7.88 x 0.50 (200.0 x 12.7) | Polyolefin | White | IJ | JL22PO-1 | 56 |
| 7.88 x 0.50 (200.0 x 12.7) | Polyolefin | White | L | PLL-22-PO-1 | 74 |
| 7.88 x 0.50 (200.0 x 12.7) | Polyolefin | Yellow | L | PLL-22-PO-1Y | 74 |
| 8.00 x 1.44 (203.2 x 36.5) | Vinyl Cloth | White | DM | PDL-342 | 121 |
| 8.00 x 1.44 (203.2 x 36.5) | Vinyl Cloth | Yellow | DM | PDL-341 | 121 |
| 8.27 x 11.69 (210.0 x 297.0) | Polyester | Clear | L | PEL-A4-Y3-25 | 77 |
| 8.27 x 11.69 (210.0 x 297.0) | Polyester | Matte Clear | L | PEL-A4-Y3M-25 | 77 |
| 8.27 x 11.69 (210.0 x 297.0) | Polyester | Silver | L | PEL-A4-Y1-25 | 77 |
| 8.27 x 11.69 (210.0 x 297.0) | Polyester | White | L | PEL-A4-Y2-25 | 77 |
| 8.27 x 11.69 (210.0 x 297.0) | Polyester | Yellow | L | PEL-A4-Y2Y-25 | 77 |
| 8.27 x 11.69 (210.0 x 297.0) | Tamp. Evid. Polyester | Silver | L | PEL-A4-Y1C-25 | 77 |
| 8.50 x 11.00 (215.9 x 279.4) | Destructible Paper | White | IJ | JL25P-SH | 56 |
| 8.50 x 11.00 (215.9 x 279.4) | Litho Paper | White | L | LL8511-100 | 75 |
| 8.50 x 11.00 (215.9 x 279.4) | Polyester | Clear | L | PLL-25-Y3C-SH | 74 |
| 8.50 x 11.00 (215.9 x 279.4) | Polyester | Silver | L | PLL-25-Y2S-SH | 74 |
| 8.50 x 11.00 (215.9 x 279.4) | Polyester | White | IJ | JL25Y-SH | 56 |
| 8.50 x 11.00 (215.9 x 279.4) | Polyester | White | L | PLL-25-Y2-SH | 74 |
| 8.50 x 11.00 (215.9 x 279.4) | Polyester | Yellow | L | PLL-25-Y2Y-SH | 74 |
| 8.50 x 11.00 (215.9 x 279.4) | Polyolefin | White | L | PLL-25-PO-SH | 74 |
| 8.50 x 11.00 (215.9 x 279.4) | Removable Polyolefin | White | L | PLL-25-POR-SH | 74 |
| 12.00 x 1.90 (304.8 x 48.3) | Vinyl Cloth | White | DM | PDL-344 | 121 |
| 12.00 x 1.90 (304.8 x 48.3) | Vinyl Cloth | Yellow | DM | PDL-343 | 121 |
| 12.00 x 2.90 (304.8 x 73.7) | Vinyl Cloth | White | DM | PDL-346 | 121 |
| 12.00 x 2.90 (304.8 x 73.7) | Vinyl Cloth | Yellow | DM | PDL-345 | 121 |
| 13.00 x 3.94 (304.8 x 100.0) | Litho Paper | White | DM | PL130315-2 | 105 |

* DM = Dot-Matrix, IJ = Ink Jet, L = Laser, TT = Thermal Transfer

Self-Laminating Labels by Size

| Label Size Width x Length In. (mm) | Print-On Area Size Width x Length In. (mm) | Material | Print-On Area Color | Print Method* | Part Number | Page No. |
|--|--|----------------------------|------------------------|------------------|-------------------|-------------|
| 0.30 x 0.75 (7.6 x 19.1) | 0.30 x 0.38 (7.6 x 9.5) | Self-Laminating Polyolefin | White | DM | PDL-239VF | 106 |
| 0.30 x 0.75 (7.6 x 19.1) | 0.30 x 0.38 (7.6 x 9.5) | Self-Laminating TEDLAR ^ | White | DM | PDL-238 | 106 |
| 0.30 x 0.75 (7.6 x 19.1) | 0.30 x 0.38 (7.6 x 9.5) | Self-Laminating Vinyl | White | DM | PDL-239 | 106 |
| 0.30 x 0.94 (7.6 x 23.8) | 0.30 x 0.38 (7.6 x 9.5) | Self-Laminating TEDLAR | White | DM | PDL-240 | 106 |
| 0.30 x 0.94 (7.6 x 23.8) | 0.30 x 0.38 (7.6 x 9.5) | Self-Laminating Vinyl | White | DM | PDL-241 | 106 |
| 0.36 x 0.94 (9.1 x 23.8) | 0.36 x 0.38 (9.1 x 9.5) | Self-Laminating TEDLAR | White | DM | PDL-169 | 106 |
| 0.36 x 0.94 (9.1 x 23.8) | 0.36 x 0.38 (9.1 x 9.5) | Self-Laminating Vinyl | White | DM | PDL-168 | 106 |
| 0.50 x 0.75 (12.7 x 19.1) | 0.50 x 0.34 (12.7 x 8.6) | Self-Laminating Polyester | White | L | PLL-3-Y3-5 | 70 |
| 0.50 x 0.75 (12.7 x 19.1) | 0.50 x 0.38 (12.7 x 9.5) | Self-Laminating TEDLAR | White | DM | PDL-118 | 106 |
| 0.50 x 0.75 (12.7 x 19.1) | 0.50 x 0.38 (12.7 x 9.5) | Self-Laminating TEDLAR | White | DM | PDL-118-1 | 106 |
| 0.50 x 0.75 (12.7 x 19.1) | 0.50 x 0.38 (12.7 x 9.5) | Self-Laminating TEDLAR | White | DM | PDL-118-10 | 106 |
| 0.50 x 0.75 (12.7 x 19.1) | 0.50 x 0.38 (12.7 x 9.5) | Self-Laminating TEDLAR | White | DM | PDL-88 | 106 |
| 0.50 x 0.75 (12.7 x 19.1) | 0.50 x 0.38 (12.7 x 9.5) | Self-Laminating Vinyl | White | DM | PDL-117 | 106 |
| 0.50 x 0.75 (12.7 x 19.1) | 0.50 x 0.38 (12.7 x 9.5) | Self-Laminating Vinyl | White | DM | PDL-42 | 106 |
| 0.50 x 0.75 (12.7 x 19.1) | 0.50 x 0.38 (12.7 x 9.5) | Self-Laminating Vinyl | White | DM | PDL-42-10 | 106 |
| 0.50 x 0.75 (12.7 x 19.1) | 0.50 x 0.41 (12.7 x 10.4) | Self-Laminating Vinyl | White | TT | TTSL8VC3-10 | 44 |
| 0.50 x 0.94 (12.7 x 23.8) | 0.50 x 0.38 (12.7 x 9.5) | Self-Laminating TEDLAR | White | DM | PDL-242 | 106 |
| 0.50 x 0.94 (12.7 x 23.8) | 0.50 x 0.38 (12.7 x 9.5) | Self-Laminating Vinyl | White | DM | PDL-243 | 106 |
| 0.50 x 1.38 (12.7 x 34.9) | 0.50 x 0.50 (12.7 x 12.7) | Self-Laminating TEDLAR | White | DM | PDL-53-10 | 106 |
| 0.50 x 1.38 (12.7 x 34.9) | 0.50 x 0.50 (12.7 x 12.7) | Self-Laminating TEDLAR | White | DM | PDL-53 | 106 |
| 0.50 x 1.38 (12.7 x 34.9) | 0.50 x 0.50 (12.7 x 12.7) | Self-Laminating TEDLAR | Blue/White | DM | PDL-53B | 106 |
| 0.50 x 1.38 (12.7 x 34.9) | 0.50 x 0.50 (12.7 x 12.7) | Self-Laminating TEDLAR | Brown/White | DM | PDL-53BR | 106 |
| 0.50 x 1.38 (12.7 x 34.9) | 0.50 x 0.50 (12.7 x 12.7) | Self-Laminating TEDLAR | Green/White | DM | PDL-53G | 106 |
| 0.50 x 1.38 (12.7 x 34.9) | 0.50 x 0.50 (12.7 x 12.7) | Self-Laminating TEDLAR | Gray/White | DM | PDL-53GR | 106 |
| 0.50 x 1.38 (12.7 x 34.9) | 0.50 x 0.50 (12.7 x 12.7) | Self-Laminating TEDLAR | Orange/White | DM | PDL-53OR | 106 |
| 0.50 x 1.38 (12.7 x 34.9) | 0.50 x 0.50 (12.7 x 12.7) | Self-Laminating TEDLAR | Purple/White | DM | PDL-53PR | 106 |
| 0.50 x 1.38 (12.7 x 34.9) | 0.50 x 0.50 (12.7 x 12.7) | Self-Laminating TEDLAR | Red/White | DM | PDL-53R | 106 |
| 0.50 x 1.38 (12.7 x 34.9) | 0.50 x 0.50 (12.7 x 12.7) | Self-Laminating TEDLAR | Yellow/White | DM | PDL-53Y | 106 |
| 0.50 x 1.44 (12.7 x 36.5) | 0.50 x 0.50 (12.7 x 12.7) | Self-Laminating Polyolefin | White | DM | PDL-1VF | 106 |
| 0.50 x 1.44 (12.7 x 36.5) | 0.50 x 0.50 (12.7 x 12.7) | Self-Laminating TEDLAR | White | DM | PDL-61 | 106 |
| 0.50 x 1.44 (12.7 x 36.5) | 0.50 x 0.50 (12.7 x 12.7) | Self-Laminating Vinyl | White | DM | PDL-1-1 | 106 |
| 0.50 x 1.44 (12.7 x 36.5) | 0.50 x 0.50 (12.7 x 12.7) | Self-Laminating Vinyl | White | DM | PDL-1-10 | 106 |
| 0.50 x 1.44 (12.7 x 36.5) | 0.50 x 0.50 (12.7 x 12.7) | Self-Laminating Vinyl | White | DM | PDL-1 | 106 |
| 0.50 x 1.44 (12.7 x 36.5) | 0.50 x 0.50 (12.7 x 12.7) | Self-Laminating Vinyl | Blue/White | DM | PDL-1B | 106 |
| 0.50 x 1.44 (12.7 x 36.5) | 0.50 x 0.50 (12.7 x 12.7) | Self-Laminating Vinyl | Brown/White | DM | PDL-1BR | 106 |
| 0.50 x 1.44 (12.7 x 36.5) | 0.50 x 0.50 (12.7 x 12.7) | Self-Laminating Vinyl | Green/White | DM | PDL-1G | 106 |
| 0.50 x 1.44 (12.7 x 36.5) | 0.50 x 0.50 (12.7 x 12.7) | Self-Laminating Vinyl | Gray/White | DM | PDL-1GR | 106 |
| 0.50 x 1.44 (12.7 x 36.5) | 0.50 x 0.50 (12.7 x 12.7) | Self-Laminating Vinyl | Orange/White | DM | PDL-1OR | 106 |
| 0.50 x 1.44 (12.7 x 36.5) | 0.50 x 0.50 (12.7 x 12.7) | Self-Laminating Vinyl | Purple/White | DM | PDL-1PR | 106 |
| 0.50 x 1.44 (12.7 x 36.5) | 0.50 x 0.50 (12.7 x 12.7) | Self-Laminating Vinyl | Red/White | DM | PDL-1R | 106 |
| 0.50 x 1.44 (12.7 x 36.5) | 0.50 x 0.50 (12.7 x 12.7) | Self-Laminating Vinyl | Yellow/white | DM | PDL-1Y | 106 |
| 0.50 x 1.44 (12.7 x 36.5) | 0.50 x 0.50 (12.7 x 12.7) | Self-Laminating Vinyl | White | DM | PDL-12 | 106 |
| 0.50 x 1.50 (12.7 x 38.1) | 0.50 x 0.50 (12.7 x 12.7) | Self-Laminating Polyester | White | L | PLL-33-Y3-5 | 70 |
| 0.50 x 1.50 (12.7 x 38.1) | 0.50 x 0.50 (12.7 x 12.7) | Self-Laminating Vinyl | White | TT | TTSL1VC3-10 | 44 |
| 0.50 x 2.00 (12.7 x 50.8) | 0.50 x 1.00 (12.7 x 25.4) | Self-Laminating Vinyl | White | TT | TTSL10VC3-5 | 44 |
| 0.60 x 1.44 (15.2 x 36.5) | 0.60 x 0.50 (15.2 x 12.7) | Self-Laminating Vinyl | White | DM | PDL-6556-2 | 106 |
| 0.70 x 1.33 (17.8 x 33.9) | 0.70 x 0.33 (17.8 x 8.5) | Self-Laminating Polyester | White | L | PEL-17-Y3-2.5 | 71 |
| 0.70 x 1.33 (17.8 x 33.9) | 0.70 x 0.33 (17.8 x 8.5) | Self-Laminating Polyester | Blue | L | PEL-17-Y3-BLU-2.5 | 71 |
| 0.70 x 1.33 (17.8 x 33.9) | 0.70 x 0.33 (17.8 x 8.5) | Self-Laminating Polyester | Brown | L | PEL-17-Y3-BRN-2.5 | 71 |
| 0.70 x 1.33 (17.8 x 33.9) | 0.70 x 0.33 (17.8 x 8.5) | Self-Laminating Polyester | Green | L | PEL-17-Y3-GRN-2.5 | 71 |
| 0.70 x 1.33 (17.8 x 33.9) | 0.70 x 0.33 (17.8 x 8.5) | Self-Laminating Polyester | Gray | L | PEL-17-Y3-GRY-2.5 | 71 |
| 0.70 x 1.33 (17.8 x 33.9) | 0.70 x 0.33 (17.8 x 8.5) | Self-Laminating Polyester | Orange | L | PEL-17-Y3-ORN-2.5 | 71 |
| 0.70 x 1.33 (17.8 x 33.9) | 0.70 x 0.33 (17.8 x 8.5) | Self-Laminating Polyester | Purple | L | PEL-17-Y3-PUR-2.5 | 71 |
| 0.70 x 1.33 (17.8 x 33.9) | 0.70 x 0.33 (17.8 x 8.5) | Self-Laminating Polyester | Red | L | PEL-17-Y3-RED-2.5 | 71 |

* DM = Dot-Matrix, IJ = Ink Jet, L = Laser, TT = Thermal Transfer
 ^TEDLAR is a registered trademark of E.I. DuPont Co.

Self-Laminating Labels by Size (cont.)

| Label Size Width x Length In. (mm) | Print-On Area Size Width x Length In. (mm) | Material | Print-On Area Color | Print Method* | Part Number | Page No. |
|--|--|-------------------------------------|------------------------|------------------|-------------------|-------------|
| 0.70 x 1.33 (17.8 x 33.9) | 0.70 x 0.33 (17.8 x 8.5) | Self-Laminating Polyester | Yellow | L | PEL-17-Y3-YEL-2.5 | 71 |
| 0.75 x 1.75 (19.1 x 44.5) | 0.75 x 0.50 (19.1 x 12.7) | Self-Laminating TEDLAR [▲] | White | DM | PDL-244 | 107 |
| 0.75 x 1.75 (19.1 x 44.5) | 0.75 x 0.50 (19.1 x 12.7) | Self-Laminating Vinyl | White | DM | PDL-245 | 107 |
| 0.75 x 1.75 (19.1 x 44.5) | 0.75 x 0.50 (19.1 x 12.7) | Self-Laminating Vinyl | White | DM | PDL-245-1 | 107 |
| 0.75 x 1.75 (19.1 x 44.5) | 0.75 x 0.50 (19.1 x 12.7) | Self-Laminating Vinyl | White | DM | PDL-245-10 | 107 |
| 0.80 x 0.94 (20.3x 23.9) | 0.80 x 0.38 (20.3 x 9.6) | Self-Laminating Vinyl | White | TT | TTSL247VC3-10 | 44 |
| 0.80 x 0.94 (20.3 x 23.8) | 0.80 x 0.38 (20.3 x 9.5) | Self-Laminating TEDLAR | White | DM | PDL-246 | 107 |
| 0.80 x 0.94 (20.3 x 23.8) | 0.80 x 0.38 (20.3 x 9.5) | Self-Laminating Vinyl | White | DM | PDL-247 | 107 |
| 0.80 x 1.44 (20.3 x 36.5) | 0.80 x 0.50 (20.3 x 12.7) | Self-Laminating Polyolefin | White | DM | PDL-8VF | 107 |
| 0.80 x 1.44 (20.3 x 36.5) | 0.80 x 0.50 (20.3 x 12.7) | Self-Laminating TEDLAR | White | DM | PDL-60 | 107 |
| 0.80 x 1.44 (20.3 x 36.5) | 0.80 x 0.50 (20.3 x 12.7) | Self-Laminating TEDLAR | Blue/White | DM | PDL-60B | 107 |
| 0.80 x 1.44 (20.3 x 36.5) | 0.80 x 0.50 (20.3 x 12.7) | Self-Laminating TEDLAR | Brown/White | DM | PDL-60BR | 107 |
| 0.80 x 1.44 (20.3 x 36.5) | 0.80 x 0.50 (20.3 x 12.7) | Self-Laminating TEDLAR | Green/White | DM | PDL-60G | 107 |
| 0.80 x 1.44 (20.3 x 36.5) | 0.80 x 0.50 (20.3 x 12.7) | Self-Laminating TEDLAR | Gray/White | DM | PDL-60GR | 107 |
| 0.80 x 1.44 (20.3 x 36.5) | 0.80 x 0.50 (20.3 x 12.7) | Self-Laminating TEDLAR | Orange/White | DM | PDL-60OR | 107 |
| 0.80 x 1.44 (20.3 x 36.5) | 0.80 x 0.50 (20.3 x 12.7) | Self-Laminating TEDLAR | Purple/White | DM | PDL-60PR | 107 |
| 0.80 x 1.44 (20.3 x 36.5) | 0.80 x 0.50 (20.3 x 12.7) | Self-Laminating TEDLAR | Red/White | DM | PDL-60R | 107 |
| 0.80 x 1.44 (20.3 x 36.5) | 0.80 x 0.50 (20.3 x 12.7) | Self-Laminating TEDLAR | Yellow/White | DM | PDL-60Y | 107 |
| 0.80 x 1.44 (20.3 x 36.5) | 0.80 x 0.50 (20.3 x 12.7) | Self-Laminating Vinyl | White | DM | PDL-8-1 | 107 |
| 0.80 x 1.44 (20.3 x 36.5) | 0.80 x 0.50 (20.3 x 12.7) | Self-Laminating Vinyl | White | DM | PDL-8-10 | 107 |
| 0.80 x 1.44 (20.3 x 36.5) | 0.80 x 0.50 (20.3 x 12.7) | Self-Laminating Vinyl | White | DM | PDL-8 | 107 |
| 0.80 x 1.44 (20.3 x 36.5) | 0.80 x 0.50 (20.3 x 12.7) | Self-Laminating Vinyl | Blue/White | DM | PDL-8B | 107 |
| 0.80 x 1.44 (20.3 x 36.5) | 0.80 x 0.50 (20.3 x 12.7) | Self-Laminating Vinyl | Brown/White | DM | PDL-8BR | 107 |
| 0.80 x 1.44 (20.3 x 36.5) | 0.80 x 0.50 (20.3 x 12.7) | Self-Laminating Vinyl | Green/White | DM | PDL-8G | 107 |
| 0.80 x 1.44 (20.3 x 36.5) | 0.80 x 0.50 (20.3 x 12.7) | Self-Laminating Vinyl | Gray/White | DM | PDL-8GR | 107 |
| 0.80 x 1.44 (20.3 x 36.5) | 0.80 x 0.50 (20.3 x 12.7) | Self-Laminating Vinyl | Orange/White | DM | PDL-8OR | 107 |
| 0.80 x 1.44 (20.3 x 36.5) | 0.80 x 0.50 (20.3 x 12.7) | Self-Laminating Vinyl | Purple/White | DM | PDL-8PR | 107 |
| 0.80 x 1.44 (20.3 x 36.5) | 0.80 x 0.50 (20.3 x 12.7) | Self-Laminating Vinyl | Red/White | DM | PDL-8R | 107 |
| 0.80 x 1.44 (20.3 x 36.5) | 0.80 x 0.50 (20.3 x 12.7) | Self-Laminating Vinyl | Yellow/White | DM | PDL-8Y | 107 |
| 0.82 x 2.00 (20.8 x 50.8) | 0.82 x 0.63 (20.8 x 15.9) | Self-Laminating Vinyl | White | DM | PDL-5859-2 | 107 |
| 0.82 x 2.00 (20.8 x 50.8) | 0.82 x 0.63 (20.8 x 15.9) | Self-Laminating Vinyl | Yellow | DM | PDL-5859-4 | 107 |
| 0.90 x 2.17 (22.9 x 55.0) | 0.90 x 0.50 (22.9 x 12.7) | Self-Laminating Polyester | White | L | PEL-18-Y3-1 | 71 |
| 0.90 x 2.17 (22.9 x 55.0) | 0.90 x 0.50 (22.9 x 12.7) | Self-Laminating Polyester | Blue | L | PEL-18-Y3-BLU-1 | 71 |
| 0.90 x 2.17 (22.9 x 55.0) | 0.90 x 0.50 (22.9 x 12.7) | Self-Laminating Polyester | Brown | L | PEL-18-Y3-BRN-1 | 71 |
| 0.90 x 2.17 (22.9 x 55.0) | 0.90 x 0.50 (22.9 x 12.7) | Self-Laminating Polyester | Green | L | PEL-18-Y3-GRN-1 | 71 |
| 0.90 x 2.17 (22.9 x 55.0) | 0.90 x 0.50 (22.9 x 12.7) | Self-Laminating Polyester | Gray | L | PEL-18-Y3-GRY-1 | 71 |
| 0.90 x 2.17 (22.9 x 55.0) | 0.90 x 0.50 (22.9 x 12.7) | Self-Laminating Polyester | Orange | L | PEL-18-Y3-ORN-1 | 71 |
| 0.90 x 2.17 (22.9 x 55.0) | 0.90 x 0.50 (22.9 x 12.7) | Self-Laminating Polyester | Purple | L | PEL-18-Y3-PUR-1 | 71 |
| 0.90 x 2.17 (22.9 x 55.0) | 0.90 x 0.50 (22.9 x 12.7) | Self-Laminating Polyester | Red | L | PEL-18-Y3-RED-1 | 71 |
| 0.90 x 2.17 (22.9 x 55.0) | 0.90 x 0.50 (22.9 x 12.7) | Self-Laminating Polyester | Yellow | L | PEL-18-Y3-YEL-1 | 71 |
| 0.90 x 2.17 (22.9 x 55.0) | 0.90 x 0.50 (22.9 x 12.7) | Self-Laminating Polyolefin | White | L | PEL-18-PO3-1 | 71 |
| 1.00 x 0.75 (25.4 x 19.1) | 1.00 x 0.34 (25.4 x 8.6) | Self-Laminating Polyester | White | L | PLL-10-Y3-2.5 | 70 |
| 1.00 x 0.75 (25.4 x 19.1) | 1.00 x 0.34 (25.4 x 8.6) | Self-Laminating Polyester | White | L | PLL-10-Y3-5 | 70 |
| 1.00 x 0.75 (25.4 x 19.1) | 1.00 x 0.35 (25.4 x 8.9) | Self-Laminating Vinyl | White | TT | TTSL-9VC3-10 | 44 |
| 1.00 x 0.75 (25.4 x 19.1) | 1.00 x 0.38 (25.4 x 9.5) | Self-Laminating Polyolefin | White | DM | PDL-249VF | 107 |
| 1.00 x 0.75 (25.4 x 19.1) | 1.00 x 0.38 (25.4 x 9.5) | Self-Laminating TEDLAR | White | DM | PDL-248 | 107 |
| 1.00 x 0.75 (25.4 x 19.1) | 1.00 x 0.38 (25.4 x 9.5) | Self-Laminating Vinyl | White | DM | PDL-249 | 107 |
| 1.00 x 0.75 (25.4 x 19.1) | 1.00 x 0.38 (25.4 x 9.5) | Self-Laminating Vinyl | White | DM | PDL-249-1 | 107 |
| 1.00 x 0.75 (25.4 x 19.1) | 1.00 x 0.38 (25.4 x 9.5) | Self-Laminating Vinyl | White | DM | PDL-249-10 | 107 |
| 1.00 x 0.94 (25.4 x 23.8) | 1.00 x 0.38 (25.4 x 9.5) | Self-Laminating TEDLAR | White | DM | PDL-250 | 107 |
| 1.00 x 0.94 (25.4 x 23.8) | 1.00 x 0.38 (25.4 x 9.5) | Self-Laminating Vinyl | White | DM | PDL-251 | 107 |
| 1.00 x 1.00 (25.4 x 25.4) | 1.00 x 0.34 (25.4 x 8.6) | Self-Laminating Polyester | White | L | PLL-11-Y3-2.5 | 70 |
| 1.00 x 1.00 (25.4 x 25.4) | 1.00 x 0.34 (25.4 x 8.6) | Self-Laminating Polyester | Blue | L | PLL-11-Y3B-2.5 | 70 |
| 1.00 x 1.00 (25.4 x 25.4) | 1.00 x 0.34 (25.4 x 8.6) | Self-Laminating Polyester | Brown | L | PLL-11-YBR3-2.5 | 70 |

* DM = Dot-Matrix, IJ = Ink Jet, L = Laser, TT = Thermal Transfer
[▲] TEDLAR is a registered trademark of E.I. DuPont Co.

Self-Laminating Labels by Size (cont.)

| Label Size Width x Length In. (mm) | Print-On Area Size Width x Length In. (mm) | Material | Print-On Area Color | Print Method* | Part Number | Page No. |
|--|--|----------------------------|------------------------|------------------|-----------------|-------------|
| 1.00 x 1.00 (25.4 x 25.4) | 1.00 x 0.34 (25.4 x 8.6) | Self-Laminating Polyester | Green | L | PLL-11-Y3G-2.5 | 70 |
| 1.00 x 1.00 (25.4 x 25.4) | 1.00 x 0.34 (25.4 x 8.6) | Self-Laminating Polyester | Gray | L | PLL-11-Y3IG-2.5 | 70 |
| 1.00 x 1.00 (25.4 x 25.4) | 1.00 x 0.34 (25.4 x 8.6) | Self-Laminating Polyester | Orange | L | PLL-11-Y3OR-2.5 | 70 |
| 1.00 x 1.00 (25.4 x 25.4) | 1.00 x 0.34 (25.4 x 8.6) | Self-Laminating Polyester | Purple | L | PLL-11-Y3PR-2.5 | 70 |
| 1.00 x 1.00 (25.4 x 25.4) | 1.00 x 0.34 (25.4 x 8.6) | Self-Laminating Polyester | Red | L | PLL-11-Y3RD-2.5 | 70 |
| 1.00 x 1.00 (25.4 x 25.4) | 1.00 x 0.34 (25.4 x 8.6) | Self-Laminating Polyester | Yellow | L | PLL-11-Y3YL-2.5 | 70 |
| 1.00 x 1.33 (25.4 x 33.8) | 1.00 x 0.50 (25.4 x 12.7) | Self-Laminating Polyester | White | L | PLL-12-Y3-1 | 70 |
| 1.00 x 1.33 (25.4 x 33.8) | 1.00 x 0.50 (25.4 x 12.7) | Self-Laminating Polyester | White | L | PLL-12-Y3-2.5 | 70 |
| 1.00 x 1.33 (25.4 x 33.8) | 1.00 x 0.50 (25.4 x 12.7) | Self-Laminating Polyester | Blue | L | PLL-12-Y3-2.5 | 70 |
| 1.00 x 1.33 (25.4 x 33.8) | 1.00 x 0.50 (25.4 x 12.7) | Self-Laminating Polyester | Brown | L | PLL-12-Y3B-2.5 | 70 |
| 1.00 x 1.33 (25.4 x 33.8) | 1.00 x 0.50 (25.4 x 12.7) | Self-Laminating Polyester | Green | L | PLL-12-YBR3-2.5 | 70 |
| 1.00 x 1.33 (25.4 x 33.8) | 1.00 x 0.50 (25.4 x 12.7) | Self-Laminating Polyester | Gray | L | PLL-12-Y3G-2.5 | 70 |
| 1.00 x 1.33 (25.4 x 33.8) | 1.00 x 0.50 (25.4 x 12.7) | Self-Laminating Polyester | Orange | L | PLL-12-Y3IG-2.5 | 70 |
| 1.00 x 1.33 (25.4 x 33.8) | 1.00 x 0.50 (25.4 x 12.7) | Self-Laminating Polyester | Purple | L | PLL-12-Y3OR-2.5 | 70 |
| 1.00 x 1.33 (25.4 x 33.8) | 1.00 x 0.50 (25.4 x 12.7) | Self-Laminating Polyester | Red | L | PLL-12-Y3RD-2.5 | 70 |
| 1.00 x 1.33 (25.4 x 33.8) | 1.00 x 0.50 (25.4 x 12.7) | Self-Laminating Polyester | Yellow | L | PLL-12-Y3RD-2.5 | 70 |
| 1.00 x 1.33 (25.4 x 33.8) | 1.00 x 0.50 (25.4 x 12.7) | Self-Laminating Polyester | White | L | PLL-39-Y3-1 | 70 |
| 1.00 x 1.38 (25.4 x 34.9) | 1.00 x 0.50 (25.4 x 12.7) | Self-Laminating TEDLAR ▲ | White | DM | PDL-54 | 108 |
| 1.00 x 1.38 (25.4 x 34.9) | 1.00 x 0.50 (25.4 x 12.7) | Self-Laminating TEDLAR | Blue/White | DM | PDL-54B | 108 |
| 1.00 x 1.38 (25.4 x 34.9) | 1.00 x 0.50 (25.4 x 12.7) | Self-Laminating TEDLAR | Brown/White | DM | PDL-54BR | 108 |
| 1.00 x 1.38 (25.4 x 34.9) | 1.00 x 0.50 (25.4 x 12.7) | Self-Laminating TEDLAR | Green/White | DM | PDL-54G | 108 |
| 1.00 x 1.38 (25.4 x 34.9) | 1.00 x 0.50 (25.4 x 12.7) | Self-Laminating TEDLAR | Gray/White | DM | PDL-54GR | 108 |
| 1.00 x 1.38 (25.4 x 34.9) | 1.00 x 0.50 (25.4 x 12.7) | Self-Laminating TEDLAR | Orange/White | DM | PDL-54OR | 108 |
| 1.00 x 1.38 (25.4 x 34.9) | 1.00 x 0.50 (25.4 x 12.7) | Self-Laminating TEDLAR | Purple/White | DM | PDL-54PR | 108 |
| 1.00 x 1.38 (25.4 x 34.9) | 1.00 x 0.50 (25.4 x 12.7) | Self-Laminating TEDLAR | Red/White | DM | PDL-54R | 108 |
| 1.00 x 1.38 (25.4 x 34.9) | 1.00 x 0.50 (25.4 x 12.7) | Self-Laminating TEDLAR | Yellow/White | DM | PDL-54Y | 108 |
| 1.00 x 1.44 (25.4 x 36.5) | 1.00 x 0.50 (25.4 x 12.7) | Self-Laminating Polyolefin | White | DM | PDL-2VF | 108 |
| 1.00 x 1.44 (25.4 x 36.5) | 1.00 x 0.50 (25.4 x 12.7) | Self-Laminating Vinyl | White | DM | PDL-2-1 | 108 |
| 1.00 x 1.44 (25.4 x 36.5) | 1.00 x 0.50 (25.4 x 12.7) | Self-Laminating Vinyl | White | DM | PDL-2-10 | 108 |
| 1.00 x 1.44 (25.4 x 36.5) | 1.00 x 0.50 (25.4 x 12.7) | Self-Laminating Vinyl | White | DM | PDL-2 | 108 |
| 1.00 x 1.44 (25.4 x 36.5) | 1.00 x 0.50 (25.4 x 12.7) | Self-Laminating Vinyl | Blue/White | DM | PDL-2B | 108 |
| 1.00 x 1.44 (25.4 x 36.5) | 1.00 x 0.50 (25.4 x 12.7) | Self-Laminating Vinyl | Brown/White | DM | PDL-2BR | 108 |
| 1.00 x 1.44 (25.4 x 36.5) | 1.00 x 0.50 (25.4 x 12.7) | Self-Laminating Vinyl | Green/White | DM | PDL-2G | 108 |
| 1.00 x 1.44 (25.4 x 36.5) | 1.00 x 0.50 (25.4 x 12.7) | Self-Laminating Vinyl | Gray/White | DM | PDL-2GR | 108 |
| 1.00 x 1.44 (25.4 x 36.5) | 1.00 x 0.50 (25.4 x 12.7) | Self-Laminating Vinyl | Orange/White | DM | PDL-2OR | 108 |
| 1.00 x 1.44 (25.4 x 36.5) | 1.00 x 0.50 (25.4 x 12.7) | Self-Laminating Vinyl | Purple/White | DM | PDL-2PR | 108 |
| 1.00 x 1.44 (25.4 x 36.5) | 1.00 x 0.50 (25.4 x 12.7) | Self-Laminating Vinyl | Red/White | DM | PDL-2R | 108 |
| 1.00 x 1.44 (25.4 x 36.5) | 1.00 x 0.50 (25.4 x 12.7) | Self-Laminating Vinyl | Yellow/White | DM | PDL-2Y | 108 |
| 1.00 x 1.44 (25.4 x 36.5) | 1.00 x 0.62 (25.4 x 15.8) | Self-Laminating Vinyl | White | DM | PDL-9025-10 | 108 |
| 1.00 x 1.50 (25.4 x 38.1) | 1.00 x 0.50 (25.4 x 12.7) | Self-Laminating Vinyl | White | TT | TTSL2VC3-10 | 44 |
| 1.00 x 2.44 (25.4 x 61.9) | 1.00 x 0.75 (25.4 x 19.1) | Self-Laminating Polyolefin | White | DM | PDL-4VF | 108 |
| 1.00 x 2.44 (25.4 x 61.9) | 1.00 x 0.75 (25.4 x 19.1) | Self-Laminating TEDLAR | White | DM | PDL-56 | 108 |
| 1.00 x 2.44 (25.4 x 61.9) | 1.00 x 0.75 (25.4 x 19.1) | Self-Laminating TEDLAR | Blue/White | DM | PDL-56B | 108 |
| 1.00 x 2.44 (25.4 x 61.9) | 1.00 x 0.75 (25.4 x 19.1) | Self-Laminating TEDLAR | Brown/White | DM | PDL-56BR | 108 |
| 1.00 x 2.44 (25.4 x 61.9) | 1.00 x 0.75 (25.4 x 19.1) | Self-Laminating TEDLAR | Green/White | DM | PDL-56G | 108 |
| 1.00 x 2.44 (25.4 x 61.9) | 1.00 x 0.75 (25.4 x 19.1) | Self-Laminating TEDLAR | Gray/White | DM | PDL-56GR | 108 |
| 1.00 x 2.44 (25.4 x 61.9) | 1.00 x 0.75 (25.4 x 19.1) | Self-Laminating TEDLAR | Orange/White | DM | PDL-56OR | 108 |
| 1.00 x 2.44 (25.4 x 61.9) | 1.00 x 0.75 (25.4 x 19.1) | Self-Laminating TEDLAR | Purple/White | DM | PDL-56PR | 108 |
| 1.00 x 2.44 (25.4 x 61.9) | 1.00 x 0.75 (25.4 x 19.1) | Self-Laminating TEDLAR | Red/White | DM | PDL-56R | 108 |
| 1.00 x 2.44 (25.4 x 61.9) | 1.00 x 0.75 (25.4 x 19.1) | Self-Laminating TEDLAR | Yellow/White | DM | PDL-56Y | 108 |
| 1.00 x 2.44 (25.4 x 61.9) | 1.00 x 0.75 (25.4 x 19.1) | Self-Laminating Vinyl | White | DM | PDL-4-10 | 108 |
| 1.00 x 2.44 (25.4 x 61.9) | 1.00 x 0.75 (25.4 x 19.1) | Self-Laminating Vinyl | White | DM | PDL-4 | 108 |
| 1.00 x 2.44 (25.4 x 61.9) | 1.00 x 0.75 (25.4 x 19.1) | Self-Laminating Vinyl | Blue/White | DM | PDL-4B | 108 |
| 1.00 x 2.44 (25.4 x 61.9) | 1.00 x 0.75 (25.4 x 19.1) | Self-Laminating Vinyl | Brown/White | DM | PDL-4BR | 108 |

* DM = Dot-Matrix, IJ = Ink Jet, L = Laser, TT = Thermal Transfer
 ▲TEDLAR is a registered trademark of E.I. DuPont Co.

Self-Laminating Labels by Size (cont.)

| Label Size Width x Length In. (mm) | Print-On Area Size Width x Length In. (mm) | Material | Print-On Area Color | Print Method* | Part Number | Page No. |
|--|--|----------------------------|------------------------|------------------|-----------------|-------------|
| 1.00 x 2.44 (25.4 x 61.9) | 1.00 x 0.75 (25.4 x 19.1) | Self-Laminating Vinyl | Green/White | DM | PDL-4G | 108 |
| 1.00 x 2.44 (25.4 x 61.9) | 1.00 x 0.75 (25.4 x 19.1) | Self-Laminating Vinyl | Gray/White | DM | PDL-4GR | 108 |
| 1.00 x 2.44 (25.4 x 61.9) | 1.00 x 0.75 (25.4 x 19.1) | Self-Laminating Vinyl | Orange/White | DM | PDL-4OR | 108 |
| 1.00 x 2.44 (25.4 x 61.9) | 1.00 x 0.75 (25.4 x 19.1) | Self-Laminating Vinyl | Purple/White | DM | PDL-4PR | 108 |
| 1.00 x 2.44 (25.4 x 61.9) | 1.00 x 0.75 (25.4 x 19.1) | Self-Laminating Vinyl | Red/White | DM | PDL-4R | 108 |
| 1.00 x 2.44 (25.4 x 61.9) | 1.00 x 0.75 (25.4 x 19.1) | Self-Laminating Vinyl | Yellow/White | DM | PDL-4Y | 108 |
| 1.00 x 2.44 (25.4 x 62.0) | 1.00 x 1.00 (25.4 x 25.4) | Self-Laminating Vinyl | White | TT | TTSL4VC3-5 | 44 |
| 1.00 x 2.67 (25.4 x 67.7) | 1.00 x 0.67 (25.4 x 16.9) | Self-Laminating Polyester | White | L | PEL-19-Y3-1 | 71 |
| 1.00 x 2.67 (25.4 x 67.7) | 1.00 x 0.67 (25.4 x 16.9) | Self-Laminating Polyester | Blue | L | PEL-19-Y3-BLU-1 | 71 |
| 1.00 x 2.67 (25.4 x 67.7) | 1.00 x 0.67 (25.4 x 16.9) | Self-Laminating Polyester | Brown | L | PEL-19-Y3-BRN-1 | 71 |
| 1.00 x 2.67 (25.4 x 67.7) | 1.00 x 0.67 (25.4 x 16.9) | Self-Laminating Polyester | Green | L | PEL-19-Y3-GRN-1 | 71 |
| 1.00 x 2.67 (25.4 x 67.7) | 1.00 x 0.67 (25.4 x 16.9) | Self-Laminating Polyester | Gray | L | PEL-19-Y3-GRY-1 | 71 |
| 1.00 x 2.67 (25.4 x 67.7) | 1.00 x 0.67 (25.4 x 16.9) | Self-Laminating Polyester | Orange | L | PEL-19-Y3-ORN-1 | 71 |
| 1.00 x 2.67 (25.4 x 67.7) | 1.00 x 0.67 (25.4 x 16.9) | Self-Laminating Polyester | Purple | L | PEL-19-Y3-PUR-1 | 71 |
| 1.00 x 2.67 (25.4 x 67.7) | 1.00 x 0.67 (25.4 x 16.9) | Self-Laminating Polyester | Red | L | PEL-19-Y3-RED-1 | 71 |
| 1.00 x 2.67 (25.4 x 67.7) | 1.00 x 0.67 (25.4 x 16.9) | Self-Laminating Polyester | Yellow | L | PEL-19-Y3-YEL-1 | 71 |
| 1.00 x 3.17 (25.4 x 80.5) | 1.00 x 0.97 (25.4 x 24.6) | Self-Laminating Polyester | White | L | PLL-13-Y3-1 | 70 |
| 1.00 x 3.17 (25.4 x 80.5) | 1.00 x 0.97 (25.4 x 24.6) | Self-Laminating Polyester | White | L | PLL-13-Y3-D | 70 |
| 1.00 x 3.87 (25.4 x 98.3) | 1.00 x 1.00 (25.4 x 25.4) | Self-Laminating TEDLAR ▲ | White | DM | PDL-58 | 109 |
| 1.00 x 3.87 (25.4 x 98.3) | 1.00 x 1.00 (25.4 x 25.4) | Self-Laminating TEDLAR | Blue/White | DM | PDL-58B | 109 |
| 1.00 x 3.87 (25.4 x 98.3) | 1.00 x 1.00 (25.4 x 25.4) | Self-Laminating TEDLAR | Brown/White | DM | PDL-58BR | 109 |
| 1.00 x 3.87 (25.4 x 98.3) | 1.00 x 1.00 (25.4 x 25.4) | Self-Laminating TEDLAR | Green/White | DM | PDL-58G | 109 |
| 1.00 x 3.87 (25.4 x 98.3) | 1.00 x 1.00 (25.4 x 25.4) | Self-Laminating TEDLAR | Gray/White | DM | PDL-58GR | 109 |
| 1.00 x 3.87 (25.4 x 98.3) | 1.00 x 1.00 (25.4 x 25.4) | Self-Laminating TEDLAR | Orange/White | DM | PDL-58OR | 109 |
| 1.00 x 3.87 (25.4 x 98.3) | 1.00 x 1.00 (25.4 x 25.4) | Self-Laminating TEDLAR | Purple/White | DM | PDL-58PR | 109 |
| 1.00 x 3.87 (25.4 x 98.3) | 1.00 x 1.00 (25.4 x 25.4) | Self-Laminating TEDLAR | Red/White | DM | PDL-58R | 109 |
| 1.00 x 3.87 (25.4 x 98.3) | 1.00 x 1.00 (25.4 x 25.4) | Self-Laminating TEDLAR | Yellow/White | DM | PDL-58Y | 109 |
| 1.00 x 3.94 (25.4 x 100.1) | 1.00 x 1.00 (25.4 x 25.4) | Self-Laminating Polyolefin | White | DM | PDL-6VF | 109 |
| 1.00 x 3.94 (25.4 x 100.1) | 1.00 x 1.00 (25.4 x 25.4) | Self-Laminating Vinyl | White | DM | PDL-6-10 | 109 |
| 1.00 x 3.94 (25.4 x 100.1) | 1.00 x 1.00 (25.4 x 25.4) | Self-Laminating Vinyl | White | DM | PDL-6-2.5 | 109 |
| 1.00 x 3.94 (25.4 x 100.1) | 1.00 x 1.00 (25.4 x 25.4) | Self-Laminating Vinyl | White | DM | PDL-6 | 109 |
| 1.00 x 3.94 (25.4 x 100.1) | 1.00 x 1.00 (25.4 x 25.4) | Self-Laminating Vinyl | Blue/White | DM | PDL-6B | 109 |
| 1.00 x 3.94 (25.4 x 100.1) | 1.00 x 1.00 (25.4 x 25.4) | Self-Laminating Vinyl | Brown/White | DM | PDL-6BR | 109 |
| 1.00 x 3.94 (25.4 x 100.1) | 1.00 x 1.00 (25.4 x 25.4) | Self-Laminating Vinyl | Green/White | DM | PDL-6G | 109 |
| 1.00 x 3.94 (25.4 x 100.1) | 1.00 x 1.00 (25.4 x 25.4) | Self-Laminating Vinyl | Gray/White | DM | PDL-6GR | 109 |
| 1.00 x 3.94 (25.4 x 100.1) | 1.00 x 1.00 (25.4 x 25.4) | Self-Laminating Vinyl | Orange/White | DM | PDL-6OR | 109 |
| 1.00 x 3.94 (25.4 x 100.1) | 1.00 x 1.00 (25.4 x 25.4) | Self-Laminating Vinyl | Purple/White | DM | PDL-6PR | 109 |
| 1.00 x 3.94 (25.4 x 100.1) | 1.00 x 1.00 (25.4 x 25.4) | Self-Laminating Vinyl | Red/White | DM | PDL-6R | 109 |
| 1.00 x 3.94 (25.4 x 100.1) | 1.00 x 1.00 (25.4 x 25.4) | Self-Laminating Vinyl | Yellow/White | DM | PDL-6Y | 109 |
| 1.00 x 3.94 (25.4 x 100.1) | 1.00 x 1.00 (25.4 x 25.4) | Self-Laminating Vinyl | White | TT | TTSL6V3-2.5 | 44 |
| 1.00 x 5.45 (25.4 x 138.4) | 1.00 x 1.00 (25.4 x 25.4) | Self-Laminating Polyester | White | L | PLL-38-Y3-1 | 70 |
| 1.00 x 5.94 (25.4 x 150.9) | 1.00 x 1.50 (25.4 x 38.1) | Self-Laminating TEDLAR | White | DM | PDL-123 | 109 |
| 1.00 x 5.94 (25.4 x 150.9) | 1.00 x 1.50 (25.4 x 38.1) | Self-Laminating TEDLAR | White | DM | PDL-95 | 109 |
| 1.00 x 5.94 (25.4 x 150.9) | 1.00 x 1.50 (25.4 x 38.1) | Self-Laminating Vinyl | White | DM | PDL-124 | 109 |
| 1.00 x 5.94 (25.4 x 150.9) | 1.00 x 1.50 (25.4 x 38.1) | Self-Laminating Vinyl | White | DM | PDL-124-10 | 109 |
| 1.00 x 5.94 (25.4 x 150.9) | 1.00 x 1.50 (25.4 x 38.1) | Self-Laminating Vinyl | White | DM | PDL-124-2.5 | 109 |
| 1.00 x 5.94 (25.4 x 150.9) | 1.00 x 1.50 (25.4 x 38.1) | Self-Laminating Vinyl | White | DM | PDL-51 | 109 |
| 1.00 x 7.44 (25.4 x 189.0) | 1.00 x 1.50 (25.4 x 38.1) | Self-Laminating TEDLAR | White | DM | PDL-125 | 109 |
| 1.00 x 7.44 (25.4 x 189.0) | 1.00 x 1.50 (25.4 x 38.1) | Self-Laminating TEDLAR | White | DM | PDL-96 | 109 |
| 1.00 x 7.44 (25.4 x 189.0) | 1.00 x 1.50 (25.4 x 38.1) | Self-Laminating Vinyl | White | DM | PDL-126 | 109 |
| 1.00 x 7.44 (25.4 x 189.0) | 1.00 x 1.50 (25.4 x 38.1) | Self-Laminating Vinyl | White | DM | PDL-126-10 | 109 |
| 1.00 x 7.44 (25.4 x 189.0) | 1.00 x 1.50 (25.4 x 38.1) | Self-Laminating Vinyl | White | DM | PDL-52 | 109 |
| 1.00 x 7.44 (25.4 x 189.0) | 1.00 x 1.50 (25.4 x 38.1) | Self-Laminating Vinyl | White | DM | PDL-52-2.5 | 109 |
| 1.13 x 3.75 (28.6 x 95.3) | 1.13 x 1.25 (28.6 x 31.8) | Self-Laminating Vinyl | White | DM | PDL-5859-1 | 109 |

* DM = Dot-Matrix, IJ = Ink Jet, L = Laser, TT = Thermal Transfer
 ▲TEDLAR is a registered trademark of E.I DuPont Co.

Self-Laminating Labels by Size (cont.)

| Label Size Width x Length In. (mm) | Print-On Area Size Width x Length In. (mm) | Material | Print-On Area Color | Print Method* | Part Number | Page No. |
|--|--|----------------------------|------------------------|------------------|-------------------|-------------|
| 1.13 x 3.75 (28.6 x 95.3) | 1.13 x 1.25 (28.6 x 31.8) | Self-Laminating Vinyl | Yellow | DM | PDL-5859-3 | 109 |
| 1.17 x 3.00 (29.6 x 76.2) | 1.17 x 0.83 (29.6 x 21.2) | Self-Laminating Vinyl | White | DM | CCS-WHT | 109 |
| 1.17 x 3.00 (29.6 x 76.2) | 1.17 x 0.83 (29.6 x 21.2) | Self-Laminating Vinyl | Yellow | DM | CCS-YEL | 109 |
| 1.20 x 2.25 (30.5 x 57.2) | 1.20 x 0.60 (30.5 x 15.2) | Self-Laminating Vinyl | White | DM | PDL-6626-10 | 109 |
| 1.20 x 2.67 (30.5 x 67.7) | 1.20 x 0.83 (30.5 x 21.2) | Self-Laminating Polyester | White | L | PEL-20-Y3-1 | 71 |
| 1.40 x 3.67 (35.6 x 93.1) | 1.40 x 1.00 (35.6 x 25.4) | Self-Laminating Polyester | White | L | PEL-21-Y3-0.5 | 71 |
| 1.40 x 3.67 (35.6 x 93.1) | 1.40 x 1.00 (35.6 x 25.4) | Self-Laminating Polyester | Blue | L | PEL-21-Y3-BLU-0.5 | 71 |
| 1.40 x 3.67 (35.6 x 93.1) | 1.40 x 1.00 (35.6 x 25.4) | Self-Laminating Polyester | Brown | L | PEL-21-Y3-BRN-0.5 | 71 |
| 1.40 x 3.67 (35.6 x 93.1) | 1.40 x 1.00 (35.6 x 25.4) | Self-Laminating Polyester | Green | L | PEL-21-Y3-GRN-0.5 | 71 |
| 1.40 x 3.67 (35.6 x 93.1) | 1.40 x 1.00 (35.6 x 25.4) | Self-Laminating Polyester | Gray | L | PEL-21-Y3-GRY-0.5 | 71 |
| 1.40 x 3.67 (35.6 x 93.1) | 1.40 x 1.00 (35.6 x 25.4) | Self-Laminating Polyester | Orange | L | PEL-21-Y3-ORN-0.5 | 71 |
| 1.40 x 3.67 (35.6 x 93.1) | 1.40 x 1.00 (35.6 x 25.4) | Self-Laminating Polyester | Purple | L | PEL-21-Y3-PUR-0.5 | 71 |
| 1.40 x 3.67 (35.6 x 93.1) | 1.40 x 1.00 (35.6 x 25.4) | Self-Laminating Polyester | Red | L | PEL-21-Y3-RED-0.5 | 71 |
| 1.40 x 3.67 (35.6 x 93.1) | 1.40 x 1.00 (35.6 x 25.4) | Self-Laminating Polyester | Yellow | L | PEL-21-Y3-YEL-0.5 | 71 |
| 1.40 x 5.50 (35.6 x 140.0) | 1.40 x 1.00 (35.6 x 25.4) | Self-Laminating Polyester | White | L | PEL-22-Y3-0.5 | 71 |
| 1.50 x 2.25 (38.1 x 57.2) | 1.50 x 0.50 (38.1 x 12.7) | Self-Laminating Vinyl | White | DM | PDL-3523-1 | 109 |
| 1.50 x 3.63 (38.1 x 92.1) | 1.50 x 0.80 (38.1 x 20.3) | Self-Laminating Vinyl | White | DM | PDL-361-1 | 109 |
| 1.80 x 5.50 (45.7 x 140.0) | 1.80 x 1.17 (45.7 x 29.6) | Self-Laminating Polyester | White | L | PEL-23-Y3-0.5 | 71 |
| 1.88 x 3.17 (47.6 x 80.5) | 1.88 x 0.97 (47.6 x 24.6) | Self-Laminating Polyester | White | L | PLL-37-Y3-1 | 70 |
| 1.90 x 3.19 (48.3 x 81.0) | 1.90 x 0.75 (48.3 x 19.1) | Self-Laminating TEDLAR ▲ | White | DM | PDL-108 | 110 |
| 1.90 x 3.19 (48.3 x 81.0) | 1.90 x 0.75 (48.3 x 19.1) | Self-Laminating TEDLAR | White | DM | PDL-64 | 110 |
| 1.90 x 3.19 (48.3 x 81.0) | 1.90 x 0.75 (48.3 x 19.1) | Self-Laminating Vinyl | White | DM | PDL-109 | 110 |
| 1.90 x 3.19 (48.3 x 81.0) | 1.90 x 0.75 (48.3 x 19.1) | Self-Laminating Vinyl | White | DM | PDL-109-2.5 | 110 |
| 1.90 x 3.19 (48.3 x 81.0) | 1.90 x 0.75 (48.3 x 19.1) | Self-Laminating Vinyl | White | DM | PDL-18 | 110 |
| 1.90 x 3.19 (48.3 x 81.0) | 1.90 x 0.75 (48.3 x 19.1) | Self-Laminating Vinyl | White | DM | PDL-18-10 | 110 |
| 1.90 x 3.19 (48.3 x 81.0) | 1.90 x 0.75 (48.3 x 19.1) | Self-Laminating Vinyl | White | DM | PDL-18-2.5 | 110 |
| 2.00 x 1.38 (50.8 x 34.9) | 2.00 x 0.50 (50.8 x 12.7) | Self-Laminating TEDLAR | White | DM | PDL-55 | 110 |
| 2.00 x 1.38 (50.8 x 34.9) | 2.00 x 0.50 (50.8 x 12.7) | Self-Laminating TEDLAR | Blue/White | DM | PDL-55B | 110 |
| 2.00 x 1.38 (50.8 x 34.9) | 2.00 x 0.50 (50.8 x 12.7) | Self-Laminating TEDLAR | Brown/White | DM | PDL-55BR | 110 |
| 2.00 x 1.38 (50.8 x 34.9) | 2.00 x 0.50 (50.8 x 12.7) | Self-Laminating TEDLAR | Green/White | DM | PDL-55G | 110 |
| 2.00 x 1.38 (50.8 x 34.9) | 2.00 x 0.50 (50.8 x 12.7) | Self-Laminating TEDLAR | Gray/White | DM | PDL-55GR | 110 |
| 2.00 x 1.38 (50.8 x 34.9) | 2.00 x 0.50 (50.8 x 12.7) | Self-Laminating TEDLAR | Orange/White | DM | PDL-55OR | 110 |
| 2.00 x 1.38 (50.8 x 34.9) | 2.00 x 0.50 (50.8 x 12.7) | Self-Laminating TEDLAR | Purple/White | DM | PDL-55PR | 110 |
| 2.00 x 1.38 (50.8 x 34.9) | 2.00 x 0.50 (50.8 x 12.7) | Self-Laminating TEDLAR | Red/White | DM | PDL-55R | 110 |
| 2.00 x 1.38 (50.8 x 34.9) | 2.00 x 0.50 (50.8 x 12.7) | Self-Laminating TEDLAR | Yellow/White | DM | PDL-55Y | 110 |
| 2.00 x 1.44 (50.8 x 36.5) | 2.00 x 0.50 (50.8 x 12.7) | Self-Laminating Polyolefin | White | DM | PDL-3VF | 110 |
| 2.00 x 1.44 (50.8 x 36.5) | 2.00 x 0.50 (50.8 x 12.7) | Self-Laminating Vinyl | White | DM | PDL-3-1 | 110 |
| 2.00 x 1.44 (50.8 x 36.5) | 2.00 x 0.50 (50.8 x 12.7) | Self-Laminating Vinyl | White | DM | PDL-3-10 | 110 |
| 2.00 x 1.44 (50.8 x 36.5) | 2.00 x 0.50 (50.8 x 12.7) | Self-Laminating Vinyl | White | DM | PDL-3 | 110 |
| 2.00 x 1.44 (50.8 x 36.5) | 2.00 x 0.50 (50.8 x 12.7) | Self-Laminating Vinyl | Blue/White | DM | PDL-3B | 110 |
| 2.00 x 1.44 (50.8 x 36.5) | 2.00 x 0.50 (50.8 x 12.7) | Self-Laminating Vinyl | Brown/White | DM | PDL-3BR | 110 |
| 2.00 x 1.44 (50.8 x 36.5) | 2.00 x 0.50 (50.8 x 12.7) | Self-Laminating Vinyl | Green/White | DM | PDL-3G | 110 |
| 2.00 x 1.44 (50.8 x 36.5) | 2.00 x 0.50 (50.8 x 12.7) | Self-Laminating Vinyl | Gray/White | DM | PDL-3GR | 110 |
| 2.00 x 1.44 (50.8 x 36.5) | 2.00 x 0.50 (50.8 x 12.7) | Self-Laminating Vinyl | Orange/White | DM | PDL-3OR | 110 |
| 2.00 x 1.44 (50.8 x 36.5) | 2.00 x 0.50 (50.8 x 12.7) | Self-Laminating Vinyl | Purple/White | DM | PDL-3PR | 110 |
| 2.00 x 1.44 (50.8 x 36.5) | 2.00 x 0.50 (50.8 x 12.7) | Self-Laminating Vinyl | Red/White | DM | PDL-3R | 110 |
| 2.00 x 1.44 (50.8 x 36.5) | 2.00 x 0.50 (50.8 x 12.7) | Self-Laminating Vinyl | Yellow/White | DM | PDL-3Y | 110 |
| 2.00 x 1.50 (50.8 x 38.1) | 2.00 x 0.50 (50.8 x 12.7) | Self-Laminating Polyester | White | L | PLL-40-Y3-1 | 70 |
| 2.00 x 1.50 (50.8 x 38.1) | 2.00 x 0.50 (50.8 x 12.7) | Self-Laminating Vinyl | White | TT | TTSL3VC3-1 | 44 |
| 2.00 x 2.44 (50.8 x 61.9) | 2.00 x 0.75 (50.8 x 19.1) | Self-Laminating Polyolefin | White | DM | PDL-5VF-10 | 110 |
| 2.00 x 2.44 (50.8 x 61.9) | 2.00 x 0.75 (50.8 x 19.1) | Self-Laminating TEDLAR | White | DM | PDL-57 | 110 |
| 2.00 x 2.44 (50.8 x 61.9) | 2.00 x 0.75 (50.8 x 19.1) | Self-Laminating TEDLAR | Blue/White | DM | PDL-57B | 110 |
| 2.00 x 2.44 (50.8 x 61.9) | 2.00 x 0.75 (50.8 x 19.1) | Self-Laminating TEDLAR | Brown/White | DM | PDL-57BR | 110 |
| 2.00 x 2.44 (50.8 x 61.9) | 2.00 x 0.75 (50.8 x 19.1) | Self-Laminating TEDLAR | Green/White | DM | PDL-57G | 110 |

* DM = Dot-Matrix, IJ = Ink Jet, L = Laser, TT = Thermal Transfer
 ▲TEDLAR is a registered trademark of E.I. DuPont Co.



Self-Laminating Labels by Size (cont.)

| Label Size Width x Length In. (mm) | Print-On Area Size Width x Length In. (mm) | Material | Print-On Area Color | Print Method* | Part Number | Page No. |
|--|--|----------------------------|------------------------|------------------|----------------|-------------|
| 2.00 x 2.44 (50.8 x 61.9) | 2.00 x 0.75 (50.8 x 19.1) | Self-Laminating TEDLAR ^ | Gray/White | DM | PDL-57GR | 110 |
| 2.00 x 2.44 (50.8 x 61.9) | 2.00 x 0.75 (50.8 x 19.1) | Self-Laminating TEDLAR | Orange/White | DM | PDL-57OR | 110 |
| 2.00 x 2.44 (50.8 x 61.9) | 2.00 x 0.75 (50.8 x 19.1) | Self-Laminating TEDLAR | Purple/White | DM | PDL-57PR | 110 |
| 2.00 x 2.44 (50.8 x 61.9) | 2.00 x 0.75 (50.8 x 19.1) | Self-Laminating TEDLAR | Red/White | DM | PDL-57R | 110 |
| 2.00 x 2.44 (50.8 x 61.9) | 2.00 x 0.75 (50.8 x 19.1) | Self-Laminating TEDLAR | Yellow/White | DM | PDL-57Y | 110 |
| 2.00 x 2.44 (50.8 x 61.9) | 2.00 x 0.75 (50.8 x 19.1) | Self-Laminating Vinyl | White | DM | PDL-5-10 | 110 |
| 2.00 x 2.44 (50.8 x 61.9) | 2.00 x 0.75 (50.8 x 19.1) | Self-Laminating Vinyl | White | DM | PDL-5-2.5 | 110 |
| 2.00 x 2.44 (50.8 x 61.9) | 2.00 x 0.75 (50.8 x 19.1) | Self-Laminating Vinyl | White | DM | PDL-5 | 110 |
| 2.00 x 2.44 (50.8 x 61.9) | 2.00 x 0.75 (50.8 x 19.1) | Self-Laminating Vinyl | Blue/White | DM | PDL-5B | 110 |
| 2.00 x 2.44 (50.8 x 61.9) | 2.00 x 0.75 (50.8 x 19.1) | Self-Laminating Vinyl | Brown/White | DM | PDL-5BR | 110 |
| 2.00 x 2.44 (50.8 x 61.9) | 2.00 x 0.75 (50.8 x 19.1) | Self-Laminating Vinyl | Green/White | DM | PDL-5G | 110 |
| 2.00 x 2.44 (50.8 x 61.9) | 2.00 x 0.75 (50.8 x 19.1) | Self-Laminating Vinyl | Gray/White | DM | PDL-5GR | 110 |
| 2.00 x 2.44 (50.8 x 61.9) | 2.00 x 0.75 (50.8 x 19.1) | Self-Laminating Vinyl | Orange/White | DM | PDL-5OR | 110 |
| 2.00 x 2.44 (50.8 x 61.9) | 2.00 x 0.75 (50.8 x 19.1) | Self-Laminating Vinyl | Purple/White | DM | PDL-5PR | 110 |
| 2.00 x 2.44 (50.8 x 61.9) | 2.00 x 0.75 (50.8 x 19.1) | Self-Laminating Vinyl | Red/White | DM | PDL-5R | 110 |
| 2.00 x 2.44 (50.8 x 61.9) | 2.00 x 0.75 (50.8 x 19.1) | Self-Laminating Vinyl | Yellow/White | DM | PDL-5Y | 110 |
| 2.00 x 3.17 (50.8 x 80.5) | 2.00 x 1.00 (50.8 x 25.4) | Self-Laminating Polyester | White | L | PLL-21-Y3-1 | 70 |
| 2.00 x 3.87 (50.8 x 98.3) | 2.00 x 1.00 (50.8 x 25.4) | Self-Laminating TEDLAR | White | DM | PDL-59-10 | 111 |
| 2.00 x 3.87 (50.8 x 98.3) | 2.00 x 1.00 (50.8 x 25.4) | Self-Laminating TEDLAR | White | DM | PDL-59 | 111 |
| 2.00 x 3.87 (50.8 x 98.3) | 2.00 x 1.00 (50.8 x 25.4) | Self-Laminating TEDLAR | Blue/White | DM | PDL-59B | 111 |
| 2.00 x 3.87 (50.8 x 98.3) | 2.00 x 1.00 (50.8 x 25.4) | Self-Laminating TEDLAR | Brown/White | DM | PDL-59BR | 111 |
| 2.00 x 3.87 (50.8 x 98.3) | 2.00 x 1.00 (50.8 x 25.4) | Self-Laminating TEDLAR | Green/White | DM | PDL-59G | 111 |
| 2.00 x 3.87 (50.8 x 98.3) | 2.00 x 1.00 (50.8 x 25.4) | Self-Laminating TEDLAR | Gray/White | DM | PDL-59GR | 111 |
| 2.00 x 3.87 (50.8 x 98.3) | 2.00 x 1.00 (50.8 x 25.4) | Self-Laminating TEDLAR | Orange/White | DM | PDL-59OR | 111 |
| 2.00 x 3.87 (50.8 x 98.3) | 2.00 x 1.00 (50.8 x 25.4) | Self-Laminating TEDLAR | Purple/White | DM | PDL-59PR | 111 |
| 2.00 x 3.87 (50.8 x 98.3) | 2.00 x 1.00 (50.8 x 25.4) | Self-Laminating TEDLAR | Red/White | DM | PDL-59R | 111 |
| 2.00 x 3.87 (50.8 x 98.3) | 2.00 x 1.00 (50.8 x 25.4) | Self-Laminating TEDLAR | Yellow/White | DM | PDL-59Y | 111 |
| 2.00 x 3.94 (50.8 x 100.1) | 2.00 x 1.00 (50.8 x 25.4) | Self-Laminating Polyolefin | White | DM | PDL-7VF | 111 |
| 2.00 x 3.94 (50.8 x 100.1) | 2.00 x 1.00 (50.8 x 25.4) | Self-Laminating Vinyl | White | DM | PDL-7-10 | 111 |
| 2.00 x 3.94 (50.8 x 100.1) | 2.00 x 1.00 (50.8 x 25.4) | Self-Laminating Vinyl | White | DM | PDL-7-2.5 | 111 |
| 2.00 x 3.94 (50.8 x 100.1) | 2.00 x 1.00 (50.8 x 25.4) | Self-Laminating Vinyl | White | DM | PDL-7 | 111 |
| 2.00 x 3.94 (50.8 x 100.1) | 2.00 x 1.00 (50.8 x 25.4) | Self-Laminating Vinyl | Blue/White | DM | PDL-7B | 111 |
| 2.00 x 3.94 (50.8 x 100.1) | 2.00 x 1.00 (50.8 x 25.4) | Self-Laminating Vinyl | Green/White | DM | PDL-7G | 111 |
| 2.00 x 3.94 (50.8 x 100.1) | 2.00 x 1.00 (50.8 x 25.4) | Self-Laminating Vinyl | Red/White | DM | PDL-7R | 111 |
| 2.00 x 3.94 (50.8 x 100.1) | 2.00 x 1.00 (50.8 x 25.4) | Self-Laminating Vinyl | Yellow/White | DM | PDL-7Y | 111 |
| 2.00 x 3.94 (50.8 x 100.1) | 2.00 x 1.00 (50.8 x 25.4) | Self-Laminating Vinyl | White | TT | TTSL7VC3-1 | 44 |
| 2.00 x 5.94 (50.8 x 150.9) | 2.00 x 1.50 (50.8 x 38.1) | Self-Laminating TEDLAR | White | DM | PDL-134 | 111 |
| 2.00 x 5.94 (50.8 x 150.9) | 2.00 x 1.50 (50.8 x 38.1) | Self-Laminating TEDLAR | White | DM | PDL-62 | 111 |
| 2.00 x 5.94 (50.8 x 150.9) | 2.00 x 1.50 (50.8 x 38.1) | Self-Laminating Vinyl | White | DM | PDL-133 | 111 |
| 2.00 x 5.94 (50.8 x 150.9) | 2.00 x 1.50 (50.8 x 38.1) | Self-Laminating Vinyl | White | DM | PDL-16 | 111 |
| 2.00 x 5.94 (50.8 x 150.9) | 2.00 x 1.50 (50.8 x 38.1) | Self-Laminating Vinyl | White | DM | PDL-16-10 | 111 |
| 2.00 x 5.94 (50.8 x 150.9) | 2.00 x 1.50 (50.8 x 38.1) | Self-Laminating Vinyl | White | DM | PDL-16-2.5 | 111 |
| 2.00 x 7.44 (50.8 x 189.0) | 2.00 x 1.50 (50.8 x 38.1) | Self-Laminating TEDLAR | White | DM | PDL-116 | 111 |
| 2.00 x 7.44 (50.8 x 189.0) | 2.00 x 1.50 (50.8 x 38.1) | Self-Laminating TEDLAR | White | DM | PDL-63 | 111 |
| 2.00 x 7.44 (50.8 x 189.0) | 2.00 x 1.50 (50.8 x 38.1) | Self-Laminating Vinyl | White | DM | PDL-115 | 111 |
| 2.00 x 7.44 (50.8 x 189.0) | 2.00 x 1.50 (50.8 x 38.1) | Self-Laminating Vinyl | White | DM | PDL-115-2.5 | 111 |
| 2.00 x 7.44 (50.8 x 189.0) | 2.00 x 1.50 (50.8 x 38.1) | Self-Laminating Vinyl | White | DM | PDL-17 | 111 |
| 2.00 x 7.44 (50.8 x 189.0) | 2.00 x 1.50 (50.8 x 38.1) | Self-Laminating Vinyl | White | DM | PDL-17-2.5 | 111 |
| 2.00 x 9.00 (50.8 x 228.6) | 2.00 x 1.50 (50.8 x 38.1) | Self-Laminating Vinyl | White | DM | PDL-362-1 | 111 |

* DM = Dot-Matrix, IJ = Ink Jet, L = Laser, TT = Thermal Transfer
 ^TEDLAR is a registered trademark of E.I DuPont Co.

PANDUIT® Wire Size Selection Guide

To use this guide, place your wire or cable in the appropriate circle to determine wire outside diameter

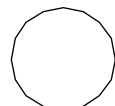
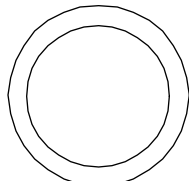
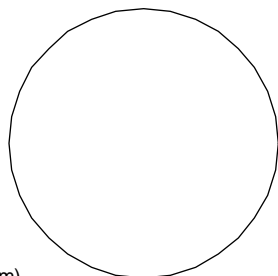
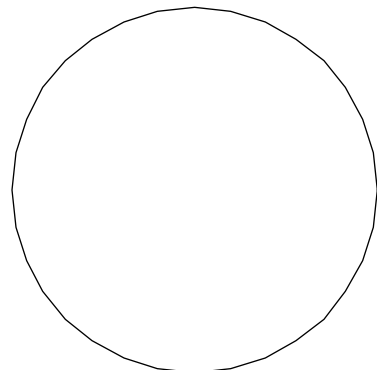
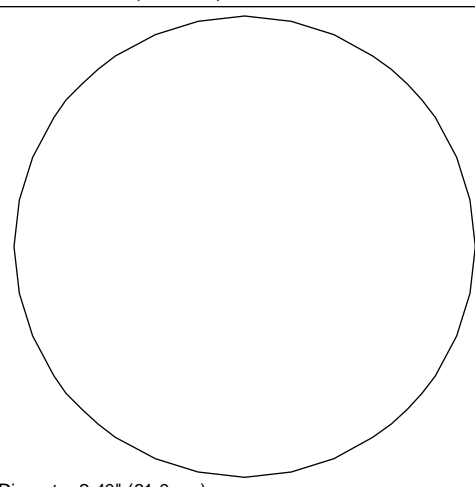
| | |
|--------------------------|---|
| Diameter 0.10" (2.5mm) |  |
| Diameter 0.20" (5.1mm) |  |
| Diameter 0.28" (7.1mm) |  |
| Diameter 0.54" (13.7mm) |  |
| Diameter 0.94" (23.9mm) |  |
| Diameter 1.40" (35.5mm) |  |
| Diameter 1.90" (48.3 mm) |  |
| Diameter 2.40" (61.0mm) |  |

The charts below indicate the approximate cable outside diameter of various electrical and communication cables.

Electrical Cables

| Size | Approx. Wire Outside Diameter In. (mm) | | | |
|----------|---|-------------|-------------|----------------------|
| | TF | THW | TW | TFN / THHN / THWN |
| 18 AWG | 0.11 (2.8) | 0.11 (2.8) | 0.11 (2.8) | 0.09 (2.3) |
| 16 AWG | 0.12 (3.0) | 0.12 (3.0) | 0.12 (3.0) | 0.10 (2.5) |
| 14 AWG | 0.13 (3.3) | 0.16 (4.1) | 0.16 (4.1) | 0.10 (2.5) |
| 12 AWG | 0.15 (3.8) | 0.18 (4.6) | 0.18 (4.6) | 0.12 (3.0) |
| 10 AWG | 0.17 (4.3) | 0.20 (5.1) | 0.20 (5.1) | 0.15 (3.8) |
| 8 AWG | 0.24 (6.1) | 0.28 (7.1) | 0.28 (7.1) | 0.22 (5.6) |
| 6 AWG | 0.32 (8.1) | 0.32 (8.1) | 0.32 (8.1) | 0.26 (6.6) |
| 4 AWG | 0.37 (9.4) | 0.37 (9.4) | 0.37 (9.4) | 0.33 (8.4) |
| 3 AWG | 0.40 (10.2) | 0.40 (10.2) | 0.40 (10.2) | 0.36 (9.1) |
| 2 AWG | 0.43 (10.9) | 0.43 (10.9) | 0.43 (10.9) | 0.39 (9.9) |
| 1 AWG | 0.51 (12.9) | 0.51 (12.9) | 0.51 (12.9) | 0.45 (11.4) |
| 1/0 | 0.55 (14.0) | 0.55 (14.0) | 0.55 (14.0) | 0.49 (12.4) |
| 2/0 | 0.59 (15.0) | 0.59 (15.0) | 0.59 (15.0) | 0.54 (13.7) |
| 3/0 | 0.65 (16.5) | 0.65 (16.5) | 0.65 (16.5) | 0.59 (15.0) |
| 4/0 | 0.70 (17.8) | 0.70 (17.8) | 0.70 (17.8) | 0.65 (16.5) |
| 250 MCM | 0.79 (20.1) | 0.79 (20.1) | 0.79 (20.1) | 0.72 (18.3) |
| 300 MCM | 0.84 (21.3) | 0.84 (21.3) | 0.84 (21.3) | 0.77 (19.6) |
| 350 MCM | 0.89 (22.6) | 0.89 (22.6) | 0.89 (22.6) | 0.82 (20.8) |
| 400 MCM | 0.94 (23.9) | 0.94 (23.9) | 0.94 (23.9) | 0.87 (22.1) |
| 500 MCM | 1.03 (26.2) | 1.03 (26.2) | 1.03 (26.2) | 0.95 (24.1) |
| 600 MCM | 1.14 (29.0) | 1.14 (29.0) | 1.14 (29.0) | 1.06 (26.9) |
| 700 MCM | 1.21 (30.7) | 1.21 (30.7) | 1.21 (30.7) | 1.13 (28.7) |
| 750 MCM | 1.25 (31.8) | 1.25 (31.8) | 1.25 (31.8) | 1.16 (29.5) |
| 800 MCM | 1.28 (32.5) | 1.28 (32.5) | 1.28 (32.5) | 1.20 (30.5) |
| 900 MCM | 1.34 (34.0) | 1.34 (34.0) | 1.34 (34.0) | 1.26 (32.0) |
| 1000 MCM | 1.40 (35.6) | 1.40 (35.6) | 1.40 (35.6) | 1.32 (33.5) |
| 1250 MCM | 1.58 (40.1) | 1.58 (40.1) | 1.58 (40.1) | |
| 1500 MCM | 1.70 (43.2) | 1.70 (43.2) | 1.70 (43.2) | |
| 1750 MCM | 1.82 (46.2) | 1.82 (46.2) | 1.82 (46.2) | |
| 2000 MCM | 1.92 (48.8) | 1.92 (48.8) | 1.92 (48.8) | |

Category 3 and Category 5 Cable

| Size | Category 3 | Category 5 | | | |
|----------|---------------------------|--------------------------|--------------------------|--------------------------|--------------------------|
| | Voice Grade 24 AWG UTP | Data Grade 24 AWG UTP | Data Grade 24 AWG STP | Data Grade 22 AWG UTP | Data Grade 22 AWG STP |
| 2 Pair | 0.12 (3.0) | | | | |
| 3 Pair | 0.15 (3.8) | | | | |
| 4 Pair | 0.19 (4.8) | 0.22 (5.6) | 0.25 (6.3) | 0.23 (5.8) | 0.29 (7.4) |
| 25 Pair | | 0.42 (10.7) | 0.51 (12.9) | 0.54 (13.7) | 0.63 (16.0) |
| 50 Pair | 0.46 (11.7) | 0.66 (16.8) | | | |
| 100 Pair | 0.63 (16.0) | 0.96 (24.4) | | | |
| 300 Pair | 1.07 (27.2) | | | | |

Coaxial Cable

| Size | Coax |
|---------|-------------|
| RG58/u | 0.19 (4.8) |
| RG59/u | 0.24 (6.1) |
| RG62A/u | 0.24 (6.1) |
| RG6/u | 0.27 (6.8) |
| RG11/u | 0.40 (10.2) |

Fiber Optic Distribution (62.5/125)

| Size | Non-Plenum | Plenum |
|-----------|-------------|-------------|
| 6 Strand | 0.26 (6.6) | 0.18 (4.6) |
| 8 Strand | 0.27 (6.9) | 0.18 (4.6) |
| 12 Strand | 0.28 (7.1) | 0.21 (5.3) |
| 18 Strand | 0.49 (12.4) | 0.47 (11.9) |
| 24 Strand | 0.54 (13.7) | 0.52 (13.2) |
| 36 Strand | 0.54 (13.7) | 0.52 (13.2) |
| 48 Strand | 0.59 (15.0) | 0.56 (14.2) |
| 72 Strand | 0.72 (18.3) | 0.71 (18.0) |

PANUIT® Alphabetical Part Number Index

| Part Number | Page |
|---------------------------|------|
| BT1.5I-C through BT4I-C | 154 |
| CCS-WHT | 109 |
| CCS-YEL | 109 |
| CORD-S | 8 |
| CPPLF-5 | 68 |
| CPPLF-5* | 68 |
| DS110 | 67 |
| DS110-* | 67 |
| EFPL-1 | 100 |
| EFPL-1* | 100 |
| EFPL10-1 | 100 |
| EFPL10-1* | 100 |
| EFPT-1 | 69 |
| EFPT10-1 | 69 |
| HLT2I-X0 through HLT3I-X0 | 152 |
| HLM-15R0 | 152 |
| HSDL9* | 122 |
| HSG-*** | 123 |
| HSTT-** | 153 |
| HTDU-** | 155 |
| HTU-** | 155 |
| JL2Y-10 | 55 |
| JL3C-10 | 55 |
| JL3Y-10 | 55 |
| JL4Y-10 | 55 |
| JL5Y-10 | 55 |
| JL7P-10 | 55 |
| JL7PO-10 | 55 |
| JL7Y-10 | 55 |
| JL8C-10 | 55 |
| JL8P-10 | 55 |
| JL8PO-10 | 55 |
| JL8Y-10 | 55 |
| JL9C-10 | 55 |
| JL9P-10 | 55 |
| JL9PO-10 | 55 |
| JL9Y-10 | 55 |
| JL10C-5 | 55 |
| JL10P-5 | 55 |
| JL10Y-5 | 55 |
| JL12P-5 | 55 |
| JL12Y-5 | 55 |
| JL14C-10 | 55 |
| JL14PO-10 | 55 |
| JL14Y-10 | 55 |
| JL15Y-10 | 55 |
| JL16PO-2.5 | 55 |
| JL16Y-5 | 55 |
| JL17P-2.5 | 56 |
| JL17PO-1 | 56 |
| JL17PO-2.5 | 56 |
| JL17Y-2.5 | 56 |
| JL18PO-1 | 56 |
| JL19PO-1 | 55 |
| JL19Y-2.5 | 55 |
| JL22PO-1 | 56 |
| JL23PO-1 | 55 |
| JL24PO-5 | 55 |
| JL25P-SH | 56 |
| JL25Y-SH | 56 |
| JL32C-10 | 55 |
| JL32Y-10 | 55 |
| JL33C-5 | 56 |
| JL33PO-2.5 | 56 |
| JL33Y-5 | 56 |
| JL35C-2.5 | 55 |
| JL35P-2.5 | 55 |
| JL35PO-2.5 | 55 |
| JL35Y-2.5 | 55 |
| JL41PO-0.5 | 56 |
| JL42PO-1 | 56 |
| JL111C-5 | 55 |

| Part Number | Page |
|-----------------------|------|
| JL111Y-5 | 55 |
| JL172P-10 | 55 |
| JL172Y-10 | 55 |
| JL274Y-10 | 55 |
| JL287Y-10 | 55 |
| JL412PO-1 | 56 |
| JL900C-2.5 | 56 |
| JL901C-5 | 55 |
| JL901PO-5 | 55 |
| JL901Y-5 | 55 |
| JL902P-2.5 | 56 |
| JL902Y-2.5 | 56 |
| JL903P-0.5 | 56 |
| JLCPL-1 | 55 |
| JLEFPD-1 | 55 |
| JLEFPS-1 | 56 |
| JSL*** | 54 |
| JT1 | 54 |
| JT500 | 54 |
| JT600 | 54 |
| JTK | 54 |
| L3PCM** | 8 |
| L3PL3CL through WH | 152 |
| LC-1 through LC-11 | 10 |
| LC-14 through LC-15 | 11 |
| LC-38 through LC-41 | 11 |
| LHS12W* | 45 |
| LHS12Y* | 45 |
| LHS18W* | 45 |
| LHS18Y* | 45 |
| LHS25W* | 45 |
| LHS25Y* | 45 |
| LHS50W* | 45 |
| LHS50Y* | 45 |
| LHS100W* | 45 |
| LHS100Y* | 45 |
| LHSW* | 10 |
| LHSY* | 10 |
| LL2561-*** | 75 |
| LL256138-100 | 75 |
| LL25615-100G | 75 |
| LL42513-100G | 75 |
| LL4252-100G | 75 |
| LL425275-250 | 75 |
| LL8511-100 | 75 |
| LS3-BS | 8 |
| LS3-CASE | 8 |
| LS3-RIB | 7 |
| LS3E | 7 |
| LS3EA | 8 |
| LS3EACS | 7 |
| LS3EAK-S | 7 |
| LS3EAP | 7 |
| LS3EC-S | 7 |
| LS3ECAP | 7 |
| LS3E-BP | 7 |
| LS3E-CP | 8 |
| LS3E-ES | 7 |
| LS3E-KIT | 7 |
| LS3E-MAN-A | 7 |
| LS3E-PS | 7 |
| LS4* | 16 |
| LS4H* | 15 |
| LS4M | 16 |
| LS5-D | 13 |
| LS5-HS* | 14 |
| LS5-KIT | 12 |
| LS5-1 through LS5-3 | 13 |
| LS5-10 through LS5-16 | 14 |
| LS5-17 through LS5-20 | 14 |
| LS5-30 | 13 |
| LS5-30C | 14 |

| Part Number | Page |
|-----------------------------|------|
| LS5-32 | 13 |
| LS5-33 | 13 |
| LS5-33C | 14 |
| LS5-33T | 13 |
| LS5-34 | 13 |
| LS5-35 | 13 |
| LS5-35C | 14 |
| LS5-37 | 13 |
| LS5-38 | 13 |
| LS5-38C | 14 |
| LS5-39 through LS5-50 | 13 |
| LS5-60 | 13 |
| LS5-70 through LS5-90 | 13 |
| LS5-530 through LS5-548 | 13 |
| LS5-DC | 12 |
| LS5-DCT | 13 |
| LS5E | 12 |
| LW* | 9 |
| LWS-1 through -54 | 9 |
| LWS-11P | 11 |
| MP150-C | 129 |
| MP175-C | 129 |
| MP200-C | 129 |
| MP250-C | 129 |
| MP250W175-C | 129 |
| MP350-C | 129 |
| PACM-0 through -25 | 138 |
| PACM-1-33 through -67-99 | 138 |
| PACM-A through -Z | 140 |
| PALM-0 through -25 | 138 |
| PALM-1-10 | 139 |
| PALM-1-33 through -67-99 | 138 |
| PALM-A through -Z | 140 |
| PALM-A-Z | 140 |
| PALM-A1 through -A2 | 141 |
| PALM-F1 through -F2 | 141 |
| PALM-L1 through -L3 | 141 |
| PALM-P1 through -P2 | 141 |
| PALM-S1 through -S2 | 141 |
| PALM-T1 through -T6 | 142 |
| PALM-X1 through -X2 | 142 |
| PARW125* | 178 |
| PCA07* through PCA45* | 150 |
| PCAY07* through PCAY45* | 150 |
| PCM-0 through -600 | 138 |
| PCM-0-9 | 139 |
| PCM-00 through -09 | 139 |
| PCM-00-09 | 139 |
| PCM-1-15SYM | 146 |
| PCM-1-3 through -1-18 | 139 |
| PCM-1-33 through -1975-1999 | 138 |
| PCM-19-36 | 139 |
| PCM-110V | 145 |
| PCM-115V | 145 |
| PCM-120V | 145 |
| PCM-12V | 145 |
| PCM-1L1 through -10L3 | 143 |
| PCM-1PH | 144 |
| PCM-1T1 through -7T3 | 143 |
| PCM-1T1-3T3 | 144 |
| PCM-220V | 145 |
| PCM-230V | 145 |
| PCM-240V | 145 |
| PCM-24V | 145 |
| PCM-277V | 145 |
| PCM-460V | 145 |
| PCM-480V | 145 |
| PCM-4T1-6T3 | 144 |
| PCM-6V | 145 |
| PCM-7T1-9T3 | 144 |
| PCM-A through -Z | 140 |
| PCM-A-MNS | 144 |

PANDUIT® Alphabetical Part Number Index

| Part Number | Page |
|---------------------------|------|
| PCM-A-PLS..... | 144 |
| PCM-A-PM..... | 144 |
| PCM-A-Z..... | 140 |
| PCM-A-Z-0-9..... | 140 |
| PCM-A1 through -A5..... | 141 |
| PCM-A1-A4..... | 142 |
| PCM-AC..... | 144 |
| PCM-APH..... | 144 |
| PCM-B-MNS..... | 144 |
| PCM-B-PLS..... | 144 |
| PCM-B1 through -B5..... | 141 |
| PCM-BAT..... | 144 |
| PCM-BLK through -YEL..... | 142 |
| PCM-BPH..... | 144 |
| PCM-C1 through -C5..... | 141 |
| PCM-COM..... | 144 |
| PCM-CPH..... | 144 |
| PCM-CYS..... | 144 |
| PCM-DC..... | 144 |
| PCM-E1 through -E5..... | 141 |
| PCM-F1 through -F5..... | 141 |
| PCM-F1-F4..... | 142 |
| PCM-GND..... | 144 |
| PCM-GRD..... | 144 |
| PCM-GRS..... | 144 |
| PCM-H1 through -H5..... | 141 |
| PCM-H1-H4..... | 142 |
| PCM-HOT..... | 144 |
| PCM-HRA..... | 144 |
| PCM-IGN..... | 144 |
| PCM-IN..... | 144 |
| PCM-INDA..... | 144 |
| PCM-J1 through -J4..... | 141 |
| PCM-L1 through -L5..... | 141 |
| PCM-L1-L4..... | 142 |
| PCM-LIN..... | 144 |
| PCM-LOAD..... | 144 |
| PCM-M1 through -M5..... | 141 |
| PCM-MIN..... | 144 |
| PCM-NEG..... | 144 |
| PCM-NEUT..... | 144 |
| PCM-OUT..... | 144 |
| PCM-P1 through -P4..... | 141 |
| PCM-PLM..... | 144 |
| PCM-PLS..... | 144 |
| PCM-POS..... | 144 |
| PCM-R1 through -R5..... | 141 |
| PCM-S1 through -S5..... | 141 |
| PCM-SPR..... | 144 |
| PCM-SS..... | 144 |
| PCM-T1 through -T10..... | 142 |
| PCM-T1-T4..... | 142 |
| PCM-W1-W4..... | 142 |
| PCM-X1 through -X4..... | 142 |
| PCM-X1-X4..... | 142 |
| PCM-Y1 through -Y4..... | 142 |
| PCM-Z1 through -Z3..... | 142 |
| PCM18R-TL..... | 19 |
| PCM18RY-TL..... | 19 |
| PCM20R-TL..... | 19 |
| PCM20RY-TL..... | 19 |
| PCM25R-TL..... | 19 |
| PCM25RY-TL..... | 19 |
| PCM33R-TL..... | 19 |
| PCM33RY-TL..... | 19 |
| PCM36R-TL..... | 19 |
| PCM36RY-TL..... | 19 |
| PCMB-1 through -25..... | 133 |
| PCMB-LC..... | 136 |
| PCMBR-*..... | 134 |
| PCMCP-*-*..... | 145 |
| PCT-75-Q..... | 179 |

| Part Number | Page |
|----------------------------|-----------|
| PCT-83-Q..... | 179 |
| PCT-91-Q..... | 179 |
| PCT-94-Q..... | 179 |
| PCT-95-Q..... | 179 |
| PCT-95F-Q..... | 180 |
| PCT-126-Q..... | 176 |
| PCT-127-Q..... | 176 |
| PCT-128-Q..... | 176 |
| PCT-141-Q..... | 176 |
| PCT-142-Q..... | 176 |
| PCT-143-Q..... | 176 |
| PCT-144-Q..... | 176 |
| PCT-168F-Q..... | 180 |
| PCT-169F-Q..... | 180 |
| PCT-170F-Q..... | 180 |
| PCT-171F-Q..... | 180 |
| PCT-172F-Q..... | 180 |
| PCT-173F-Q..... | 180 |
| PCT-174F-Q..... | 180 |
| PCT-175F-Q..... | 180 |
| PCT-178F-Q..... | 180 |
| PCT-179F-Q..... | 180 |
| PCT-180F-Q..... | 180 |
| PCT-182F-Q..... | 180 |
| PCT-183-Q..... | 179 |
| PCT-184-Q..... | 179 |
| PCT-185-Q..... | 179 |
| PCT-186-Q..... | 179 |
| PCT-187-Q..... | 179 |
| PCT-188-Q..... | 179 |
| PCT-189-Q..... | 179 |
| PCT-190-Q..... | 179 |
| PCT-191-Q..... | 179 |
| PCT-192-Q..... | 179 |
| PCT-193-Q..... | 179 |
| PCT-194-Q..... | 179 |
| PCT-195-Q..... | 179 |
| PCT-196-Q..... | 179 |
| PCT-197-Q..... | 179 |
| PCT-204-Q thru -211-Q..... | 175 |
| PCT-216-Q..... | 176 |
| PCT-217-Q..... | 176 |
| PCV***..... | 157 - 158 |
| PCWL*..... | 172 |
| PCWLL*..... | 172 |
| PCYMB-1 through -9..... | 133 |
| PDL-1..... | 106 |
| PDL-1-1..... | 106 |
| PDL-1-10..... | 106 |
| PDL-1*..... | 106 |
| PDL-1VF..... | 106 |
| PDL-2..... | 108 |
| PDL-2-1..... | 108 |
| PDL-2-10..... | 108 |
| PDL-2*..... | 108 |
| PDL-2VF..... | 108 |
| PDL-3..... | 110 |
| PDL-3-1..... | 110 |
| PDL-3-10..... | 110 |
| PDL-3*..... | 110 |
| PDL-3VF..... | 110 |
| PDL-4..... | 108 |
| PDL-4-10..... | 108 |
| PDL-4*..... | 108 |
| PDL-5..... | 110 |
| PDL-5-2.5..... | 110 |
| PDL-5-10..... | 110 |
| PDL-5*..... | 110 |
| PDL-5VF-10..... | 110 |
| PDL-6..... | 109 |
| PDL-6-2.5..... | 109 |
| PDL-6-10..... | 109 |

| Part Number | Page |
|-----------------|------|
| PDL-6*..... | 109 |
| PDL-7..... | 111 |
| PDL-7-2.5..... | 111 |
| PDL-7-10..... | 111 |
| PDL-7*..... | 111 |
| PDL-8..... | 107 |
| PDL-8-1..... | 107 |
| PDL-8-10..... | 107 |
| PDL-8*..... | 107 |
| PDL-9..... | 116 |
| PDL-9-10..... | 116 |
| PDL-9-10T..... | 116 |
| PDL-10..... | 116 |
| PDL-10-1..... | 116 |
| PDL-11..... | 116 |
| PDL-12..... | 106 |
| PDL-13..... | 113 |
| PDL-13-1..... | 113 |
| PDL-13-10..... | 113 |
| PDL-14..... | 113 |
| PDL-14-10..... | 113 |
| PDL-15..... | 113 |
| PDL-16..... | 111 |
| PDL-16-2.5..... | 111 |
| PDL-16-10..... | 111 |
| PDL-17..... | 111 |
| PDL-17-2.5..... | 111 |
| PDL-18..... | 110 |
| PDL-18-2.5..... | 110 |
| PDL-18-10..... | 110 |
| PDL-19..... | 117 |
| PDL-19-1..... | 117 |
| PDL-19-10..... | 117 |
| PDL-20..... | 117 |
| PDL-20-1..... | 117 |
| PDL-20-10..... | 117 |
| PDL-21..... | 117 |
| PDL-21-1..... | 117 |
| PDL-21-10..... | 117 |
| PDL-22..... | 117 |
| PDL-22-1..... | 117 |
| PDL-22-10..... | 117 |
| PDL-23..... | 116 |
| PDL-23-1..... | 116 |
| PDL-23-10..... | 116 |
| PDL-24..... | 118 |
| PDL-25..... | 118 |
| PDL-25-10..... | 118 |
| PDL-26..... | 118 |
| PDL-27..... | 119 |
| PDL-27-10..... | 119 |
| PDL-28..... | 119 |
| PDL-29..... | 119 |
| PDL-29-1..... | 119 |
| PDL-29-10..... | 119 |
| PDL-30..... | 116 |
| PDL-30-1..... | 116 |
| PDL-30-10..... | 116 |
| PDL-31..... | 116 |
| PDL-31-10..... | 116 |
| PDL-32..... | 119 |
| PDL-32-1..... | 119 |
| PDL-32-10..... | 119 |
| PDL-33..... | 120 |
| PDL-34..... | 114 |
| PDL-34-1..... | 114 |
| PDL-34-10..... | 114 |
| PDL-35..... | 114 |
| PDL-35-1..... | 114 |
| PDL-35-10..... | 114 |
| PDL-36..... | 114 |
| PDL-36-10..... | 114 |

| Part Number | Page |
|-------------|------|
| PDL-37 | 115 |
| PDL-37-1 | 115 |
| PDL-37-10 | 115 |
| PDL-37-50 | 115 |
| PDL-38 | 115 |
| PDL-38-10 | 115 |
| PDL-39 | 115 |
| PDL-39-10 | 115 |
| PDL-40 | 118 |
| PDL-40-10 | 118 |
| PDL-41 | 118 |
| PDL-41-1 | 118 |
| PDL-41-10 | 118 |
| PDL-42 | 106 |
| PDL-42-10 | 106 |
| PDL-43 | 113 |
| PDL-43-10 | 113 |
| PDL-44 | 113 |
| PDL-45 | 113 |
| PDL-45-1 | 113 |
| PDL-45-10 | 113 |
| PDL-46 | 113 |
| PDL-47 | 113 |
| PDL-47-10 | 113 |
| PDL-48 | 113 |
| PDL-48-1 | 113 |
| PDL-48-10 | 113 |
| PDL-49 | 116 |
| PDL-49-10 | 116 |
| PDL-50 | 116 |
| PDL-50-10 | 116 |
| PDL-51 | 109 |
| PDL-52 | 109 |
| PDL-52-2.5 | 109 |
| PDL-53 | 106 |
| PDL-53-10 | 106 |
| PDL-53* | 106 |
| PDL-54 | 108 |
| PDL-54* | 108 |
| PDL-55 | 110 |
| PDL-55* | 110 |
| PDL-56 | 108 |
| PDL-56* | 108 |
| PDL-57 | 110 |
| PDL-57* | 110 |
| PDL-58 | 109 |
| PDL-58* | 109 |
| PDL-59 | 111 |
| PDL-59-10 | 111 |
| PDL-59* | 111 |
| PDL-60 | 107 |
| PDL-60* | 107 |
| PDL-61 | 106 |
| PDL-62 | 111 |
| PDL-63 | 111 |
| PDL-64 | 110 |
| PDL-65 | 117 |
| PDL-66 | 116 |
| PDL-67 | 116 |
| PDL-68 | 116 |
| PDL-69 | 118 |
| PDL-70 | 118 |
| PDL-71 | 118 |
| PDL-72 | 119 |
| PDL-73 | 119 |
| PDL-73-10 | 119 |
| PDL-74 | 116 |
| PDL-75 | 116 |
| PDL-76 | 119 |
| PDL-77 | 119 |
| PDL-78 | 119 |
| PDL-79 | 120 |

| Part Number | Page |
|-------------|------|
| PDL-80 | 120 |
| PDL-81 | 120 |
| PDL-82 | 114 |
| PDL-83 | 114 |
| PDL-83-10 | 114 |
| PDL-84 | 115 |
| PDL-85 | 115 |
| PDL-86 | 118 |
| PDL-87 | 118 |
| PDL-87-10 | 118 |
| PDL-88 | 106 |
| PDL-89 | 113 |
| PDL-90 | 113 |
| PDL-91 | 113 |
| PDL-92 | 116 |
| PDL-93 | 116 |
| PDL-94 | 116 |
| PDL-94-1 | 116 |
| PDL-94-10 | 116 |
| PDL-95 | 109 |
| PDL-96 | 109 |
| PDL-97 | 117 |
| PDL-98 | 117 |
| PDL-99 | 117 |
| PDL-99-10 | 117 |
| PDL-100 | 112 |
| PDL-101 | 112 |
| PDL-102 | 112 |
| PDL-103 | 112 |
| PDL-104 | 113 |
| PDL-105 | 113 |
| PDL-106 | 113 |
| PDL-106-1 | 113 |
| PDL-106-10 | 113 |
| PDL-107 | 113 |
| PDL-108 | 110 |
| PDL-109 | 110 |
| PDL-109-2.5 | 110 |
| PDL-110 | 119 |
| PDL-110-1 | 119 |
| PDL-111 | 119 |
| PDL-111-1 | 119 |
| PDL-112 | 119 |
| PDL-113 | 119 |
| PDL-114 | 119 |
| PDL-115 | 111 |
| PDL-115-2.5 | 111 |
| PDL-116 | 111 |
| PDL-117 | 106 |
| PDL-118 | 106 |
| PDL-118-1 | 106 |
| PDL-118-10 | 106 |
| PDL-119 | 113 |
| PDL-120 | 113 |
| PDL-120-10 | 113 |
| PDL-121 | 113 |
| PDL-122 | 113 |
| PDL-123 | 109 |
| PDL-124 | 109 |
| PDL-124-2.5 | 109 |
| PDL-124-10 | 109 |
| PDL-125 | 109 |
| PDL-126 | 109 |
| PDL-126-10 | 109 |
| PDL-127 | 118 |
| PDL-128 | 118 |
| PDL-128-10 | 118 |
| PDL-129 | 118 |
| PDL-130 | 118 |
| PDL-131 | 118 |
| PDL-132 | 118 |
| PDL-132-10 | 118 |

| Part Number | Page |
|-------------|------|
| PDL-133 | 111 |
| PDL-134 | 111 |
| PDL-135 | 114 |
| PDL-136 | 114 |
| PDL-137 | 114 |
| PDL-138 | 114 |
| PDL-139 | 120 |
| PDL-140 | 120 |
| PDL-141 | 120 |
| PDL-142 | 120 |
| PDL-143 | 120 |
| PDL-144 | 120 |
| PDL-145 | 119 |
| PDL-146 | 119 |
| PDL-147 | 119 |
| PDL-148 | 119 |
| PDL-149 | 119 |
| PDL-150 | 119 |
| PDL-151 | 120 |
| PDL-152 | 120 |
| PDL-153 | 120 |
| PDL-154 | 120 |
| PDL-155 | 120 |
| PDL-156 | 120 |
| PDL-157 | 117 |
| PDL-158 | 117 |
| PDL-159 | 121 |
| PDL-160 | 121 |
| PDL-161 | 121 |
| PDL-162 | 121 |
| PDL-163 | 120 |
| PDL-164 | 120 |
| PDL-165 | 120 |
| PDL-166 | 120 |
| PDL-167 | 115 |
| PDL-168 | 106 |
| PDL-169 | 106 |
| PDL-170 | 115 |
| PDL-170-10 | 115 |
| PDL-171 | 115 |
| PDL-172 | 115 |
| PDL-172-10 | 115 |
| PDL-172R | 115 |
| PDL-173 | 115 |
| PDL-174 | 115 |
| PDL-175 | 116 |
| PDL-176 | 112 |
| PDL-177 | 112 |
| PDL-178 | 112 |
| PDL-179 | 112 |
| PDL-180 | 112 |
| PDL-181 | 112 |
| PDL-182 | 112 |
| PDL-183 | 112 |
| PDL-184 | 113 |
| PDL-185 | 113 |
| PDL-186 | 113 |
| PDL-187 | 113 |
| PDL-188 | 117 |
| PDL-189 | 114 |
| PDL-190 | 115 |
| PDL-191 | 115 |
| PDL-192 | 115 |
| PDL-193 | 114 |
| PDL-194 | 114 |
| PDL-230 | 117 |
| PDL-231 | 119 |
| PDL-231-10 | 119 |
| PDL-232 | 120 |
| PDL-233 | 114 |
| PDL-233-10 | 114 |
| PDL-234 | 114 |

PANDUIT® Alphabetical Part Number Index

| Part Number | Page |
|-------------|------|
| PDL-234-10 | 114 |
| PDL-235 | 115 |
| PDL-235-10 | 115 |
| PDL-236 | 115 |
| PDL-236-10 | 115 |
| PDL-237 | 119 |
| PDL-238 | 106 |
| PDL-239 | 106 |
| PDL-239VF | 106 |
| PDL-240 | 106 |
| PDL-241 | 106 |
| PDL-242 | 106 |
| PDL-243 | 106 |
| PDL-244 | 107 |
| PDL-245 | 107 |
| PDL-245-1 | 107 |
| PDL-245-10 | 107 |
| PDL-246 | 107 |
| PDL-247 | 107 |
| PDL-248 | 107 |
| PDL-249 | 107 |
| PDL-249-1 | 107 |
| PDL-249-10 | 107 |
| PDL-249VF | 107 |
| PDL-250 | 107 |
| PDL-251 | 107 |
| PDL-252 | 112 |
| PDL-252-10 | 112 |
| PDL-253 | 112 |
| PDL-253-10 | 112 |
| PDL-254 | 112 |
| PDL-256 | 112 |
| PDL-257 | 112 |
| PDL-259 | 112 |
| PDL-260 | 112 |
| PDL-262 | 112 |
| PDL-262-10 | 112 |
| PDL-263 | 112 |
| PDL-264 | 112 |
| PDL-264-10 | 112 |
| PDL-265 | 113 |
| PDL-267 | 113 |
| PDL-269 | 114 |
| PDL-270 | 115 |
| PDL-272 | 115 |
| PDL-273 | 115 |
| PDL-274 | 115 |
| PDL-274-10 | 115 |
| PDL-275 | 115 |
| PDL-276 | 115 |
| PDL-277 | 115 |
| PDL-277-10 | 115 |
| PDL-278 | 115 |
| PDL-279 | 115 |
| PDL-279-10 | 115 |
| PDL-280 | 116 |
| PDL-280-10 | 116 |
| PDL-282 | 116 |
| PDL-283 | 116 |
| PDL-284 | 116 |
| PDL-285 | 116 |
| PDL-286 | 116 |
| PDL-287 | 116 |
| PDL-288 | 117 |
| PDL-290 | 117 |
| PDL-290-1 | 117 |
| PDL-291 | 117 |
| PDL-293 | 117 |
| PDL-294 | 117 |
| PDL-296 | 117 |
| PDL-297 | 119 |
| PDL-298 | 119 |

| Part Number | Page |
|-------------|------|
| PDL-299 | 119 |
| PDL-300 | 119 |
| PDL-301 | 119 |
| PDL-302 | 119 |
| PDL-303 | 120 |
| PDL-304 | 120 |
| PDL-305 | 120 |
| PDL-305-10 | 120 |
| PDL-306 | 120 |
| PDL-307 | 120 |
| PDL-308 | 120 |
| PDL-309 | 120 |
| PDL-310 | 120 |
| PDL-311 | 120 |
| PDL-312 | 120 |
| PDL-313 | 120 |
| PDL-314 | 120 |
| PDL-315 | 120 |
| PDL-316 | 120 |
| PDL-317 | 120 |
| PDL-318 | 120 |
| PDL-319 | 120 |
| PDL-320 | 120 |
| PDL-321 | 121 |
| PDL-322 | 121 |
| PDL-323 | 121 |
| PDL-324 | 121 |
| PDL-325 | 121 |
| PDL-326 | 121 |
| PDL-327 | 121 |
| PDL-328 | 121 |
| PDL-329 | 121 |
| PDL-330 | 121 |
| PDL-331 | 121 |
| PDL-332 | 121 |
| PDL-333 | 121 |
| PDL-334 | 121 |
| PDL-335 | 121 |
| PDL-336 | 121 |
| PDL-337 | 121 |
| PDL-338 | 121 |
| PDL-339 | 121 |
| PDL-340 | 121 |
| PDL-341 | 121 |
| PDL-342 | 121 |
| PDL-343 | 121 |
| PDL-344 | 121 |
| PDL-345 | 121 |
| PDL-346 | 121 |
| PDL-347 | 112 |
| PDL-349 | 112 |
| PDL-351 | 112 |
| PDL-353 | 112 |
| PDL-355 | 112 |
| PDL-357 | 118 |
| PDL-358 | 118 |
| PDL-359-10 | 118 |
| PDL-360-10 | 118 |
| PDL-361-1 | 109 |
| PDL-362-1 | 111 |
| PDL-363 | 117 |
| PDL-370 | 118 |
| PDL-400 | 114 |
| PDL-401 | 114 |
| PDL-401-10 | 114 |
| PDL-401-D | 114 |
| PDL-402-10 | 114 |
| PDL-402-D | 114 |
| PDL-403-1 | 121 |
| PDL-403-2.5 | 121 |
| PDL-403-1* | 121 |
| PDL-404-1 | 121 |

| Part Number | Page |
|---------------|---------|
| PDL-404-2.5 | 121 |
| PDL-405-10 | 114 |
| PDL-405-D | 114 |
| PDL-406-10 | 114 |
| PDL-406-D | 114 |
| PDL-407-1 | 118 |
| PDL-408-TL | 119 |
| PDL-409-1 | 118 |
| PDL-410-TL | 120 |
| PDL-411-1 | 99 |
| PDL-411-1* | 99 |
| PDL-412 | 99 |
| PDL-500 | 90 |
| PDL-629 | 118 |
| PDL-3523-1 | 109 |
| PDL-4565-1 | 116 |
| PDL-4565-2 | 117 |
| PDL-4674-1 | 117 |
| PDL-4674-3 | 117 |
| PDL-5712-2 | 118 |
| PDL-5859-1 | 109 |
| PDL-5859-2 | 107 |
| PDL-5859-3 | 109 |
| PDL-5859-4 | 107 |
| PDL-6556-2 | 106 |
| PDL-6626-10 | 109 |
| PDL-7294-1 | 117 |
| PDL-7517 | 119 |
| PDL-7542-10 | 118 |
| PDL-7557-1 | 120 |
| PDL-7572-10R | 119 |
| PDL-7572-1R | 119 |
| PDL-7966-10 | 112 |
| PDL-9025-10 | 108 |
| PDL-PROG-LT | 29 |
| PDL110G5 | 119 |
| PDLR* | 127-128 |
| PDOT25* | 178 |
| PDP* | 125 |
| PECWMS* | 101 |
| PEDL* | 101 |
| PEIP-A* | 177 |
| PEIP-C* | 177 |
| PEIP-D* | 177 |
| PEL-1-Y1-10 | 76 |
| PEL-1-Y2-10 | 76 |
| PEL-2-Y1-10 | 76 |
| PEL-2-Y2-10 | 76 |
| PEL-2-Y2Y-10 | 76 |
| PEL-2-Y3M-10 | 76 |
| PEL-3-Y1-5 | 77 |
| PEL-3-Y1C-5 | 77 |
| PEL-3-Y2-5 | 77 |
| PEL-4-Y1-10 | 76 |
| PEL-4-Y1C-10 | 76 |
| PEL-4-Y2-10 | 76 |
| PEL-4-Y2Y-10 | 76 |
| PEL-5-Y1-10 | 76 |
| PEL-5-Y2-10 | 76 |
| PEL-5-Y2Y-10 | 76 |
| PEL-6-Y1-5 | 76 |
| PEL-6-Y1C-5 | 76 |
| PEL-6-Y2-5 | 76 |
| PEL-7-Y1-5 | 77 |
| PEL-7-Y2-5 | 77 |
| PEL-7-Y2Y-5 | 77 |
| PEL-7-Y3M-5 | 77 |
| PEL-8-Y1-2.5 | 77 |
| PEL-8-Y1C-2.5 | 77 |
| PEL-8-Y2-2.5 | 77 |
| PEL-9-Y1-10 | 76 |
| PEL-9-Y1C-10 | 76 |

| Part Number | Page |
|----------------|------|
| PEL-9-Y2-10 | 76 |
| PEL-10-Y1-5 | 76 |
| PEL-10-Y2-5 | 76 |
| PEL-10-Y2Y-5 | 76 |
| PEL-10-Y3M-5 | 76 |
| PEL-11-Y1-5 | 76 |
| PEL-11-Y1C-5 | 76 |
| PEL-11-Y2-5 | 76 |
| PEL-11-Y2Y-5 | 76 |
| PEL-12-Y1-2.5 | 77 |
| PEL-12-Y2-2.5 | 77 |
| PEL-12-Y2Y-2.5 | 77 |
| PEL-13-Y1-2.5 | 77 |
| PEL-13-Y2-2.5 | 77 |
| PEL-14-Y1-1 | 77 |
| PEL-14-Y2-1 | 77 |
| PEL-15-Y1-1 | 77 |
| PEL-15-Y1C-1 | 77 |
| PEL-15-Y2-1 | 77 |
| PEL-15-Y2Y-1 | 77 |
| PEL-16-Y1-0.5 | 77 |
| PEL-16-Y1C-0.5 | 77 |
| PEL-16-Y2-0.5 | 77 |
| PEL-17-***-2.5 | 71 |
| PEL-17-Y3-2.5 | 71 |
| PEL-18-***-1 | 71 |
| PEL-18-Y3-1 | 71 |
| PEL-19-***-1 | 71 |
| PEL-19-Y3-1 | 71 |
| PEL-20-Y3-1 | 71 |
| PEL-21-***-0.5 | 71 |
| PEL-21-Y3-0.5 | 71 |
| PEL-22-Y3-0.5 | 71 |
| PEL-23-Y3-0.5 | 71 |
| PEL-24-Y2Y-10 | 76 |
| PEL-25-Y2Y-10 | 76 |
| PEL-26-Y2Y-5 | 76 |
| PEL-27-Y2Y-5 | 76 |
| PEL-28-Y2-5 | 76 |
| PEL-28-Y3M-5 | 76 |
| PEL-29-Y2-10 | 76 |
| PEL-29-Y3M-10 | 76 |
| PEL-A4-Y1-25 | 77 |
| PEL-A4-Y1C-25 | 77 |
| PEL-A4-Y2-25 | 77 |
| PEL-A4-Y2Y-25 | 77 |
| PEL-A4-Y3-25 | 77 |
| PEL-A4-Y3M-25 | 77 |
| PES-L*Q | 176 |
| PESC-A-***V | 159 |
| PESC-B-***V | 159 |
| PESC-C-***V | 159 |
| PESC-D-***V | 159 |
| PESC-F-*** | 159 |
| PESC-H-** | 160 |
| PESC-J-** | 160 |
| PESG-A-1 | 167 |
| PESG-B-1 | 167 |
| PESG-C-1 | 167 |
| PESG-D-1 | 167 |
| PESS-A-AQ | 147 |
| PESS-A-CE | 147 |
| PESS-A-CECC | 177 |
| PESS-A-E | 147 |
| PESS-A-ES | 147 |
| PESS-A-EX1 | 147 |
| PESS-A-EX2 | 147 |
| PESS-A-FS | 147 |
| PESS-A-GS1 | 177 |
| PESS-A-GS2 | 177 |
| PESS-A-L+ | 147 |
| PESS-A-L- | 147 |

| Part Number | Page |
|-------------|------|
| PESS-A-L1 | 147 |
| PESS-A-L2 | 147 |
| PESS-A-L3 | 147 |
| PESS-A-M | 147 |
| PESS-A-MM | 147 |
| PESS-A-N | 147 |
| PESS-A-NS | 147 |
| PESS-A-PE | 147 |
| PESS-A-PEN | 147 |
| PESS-A-PS | 147 |
| PESS-A-PU | 147 |
| PESS-A-SCH | 147 |
| PESS-A-SG | 147 |
| PESS-A-SS | 147 |
| PESS-A-SU | 147 |
| PESS-A-TE | 147 |
| PESS-A-VDE1 | 177 |
| PESS-A-VDE2 | 177 |
| PESS-A-VDE3 | 177 |
| PESS-B-AQ | 147 |
| PESS-B-CE | 147 |
| PESS-B-CECC | 177 |
| PESS-B-E | 147 |
| PESS-B-ES | 147 |
| PESS-B-EX1 | 147 |
| PESS-B-EX2 | 147 |
| PESS-B-FS | 147 |
| PESS-B-GS1 | 177 |
| PESS-B-GS2 | 177 |
| PESS-B-L+ | 147 |
| PESS-B-L- | 147 |
| PESS-B-L1 | 147 |
| PESS-B-L2 | 147 |
| PESS-B-L3 | 147 |
| PESS-B-M | 147 |
| PESS-B-MM | 147 |
| PESS-B-N | 147 |
| PESS-B-NS | 147 |
| PESS-B-PE | 147 |
| PESS-B-PEN | 147 |
| PESS-B-PS | 147 |
| PESS-B-PU | 147 |
| PESS-B-SCH | 147 |
| PESS-B-SG | 147 |
| PESS-B-SS | 147 |
| PESS-B-SU | 147 |
| PESS-B-TE | 147 |
| PESS-B-VDE1 | 177 |
| PESS-B-VDE2 | 177 |
| PESS-B-VDE3 | 177 |
| PESS-C-AQ | 147 |
| PESS-C-CE | 147 |
| PESS-C-CECC | 177 |
| PESS-C-E | 147 |
| PESS-C-ES | 147 |
| PESS-C-EX1 | 147 |
| PESS-C-EX2 | 147 |
| PESS-C-FS | 147 |
| PESS-C-GS1 | 177 |
| PESS-C-GS2 | 177 |
| PESS-C-L+ | 147 |
| PESS-C-L- | 147 |
| PESS-C-L1 | 147 |
| PESS-C-L2 | 147 |
| PESS-C-L3 | 147 |
| PESS-C-M | 147 |
| PESS-C-MM | 147 |
| PESS-C-N | 147 |
| PESS-C-NS | 147 |
| PESS-C-PE | 147 |
| PESS-C-PEN | 147 |
| PESS-C-PS | 147 |

| Part Number | Page |
|-------------|------|
| PESS-C-PU | 147 |
| PESS-C-SCH | 147 |
| PESS-C-SG | 147 |
| PESS-C-SS | 147 |
| PESS-C-SU | 147 |
| PESS-C-TE | 147 |
| PESS-C-VDE1 | 177 |
| PESS-C-VDE2 | 177 |
| PESS-C-VDE3 | 177 |
| PESS-D-AQ | 147 |
| PESS-D-CE | 147 |
| PESS-D-CECC | 177 |
| PESS-D-E | 147 |
| PESS-D-ES | 147 |
| PESS-D-EX1 | 147 |
| PESS-D-EX2 | 147 |
| PESS-D-FS | 147 |
| PESS-D-GS1 | 177 |
| PESS-D-GS2 | 177 |
| PESS-D-L+ | 147 |
| PESS-D-L- | 147 |
| PESS-D-L1 | 147 |
| PESS-D-L2 | 147 |
| PESS-D-L3 | 147 |
| PESS-D-M | 147 |
| PESS-D-MM | 147 |
| PESS-D-N | 147 |
| PESS-D-NS | 147 |
| PESS-D-PE | 147 |
| PESS-D-PEN | 147 |
| PESS-D-PS | 147 |
| PESS-D-PU | 147 |
| PESS-D-SCH | 147 |
| PESS-D-SG | 147 |
| PESS-D-SS | 147 |
| PESS-D-SU | 147 |
| PESS-D-TE | 147 |
| PESS-D-VDE1 | 177 |
| PESS-D-VDE2 | 177 |
| PESS-D-VDE3 | 177 |
| PESS-E-AQ | 147 |
| PESS-E-CE | 147 |
| PESS-E-CECC | 177 |
| PESS-E-E | 147 |
| PESS-E-ES | 147 |
| PESS-E-EX1 | 147 |
| PESS-E-EX2 | 147 |
| PESS-E-FS | 147 |
| PESS-E-GS1 | 177 |
| PESS-E-GS2 | 177 |
| PESS-E-L+ | 147 |
| PESS-E-L- | 147 |
| PESS-E-L1 | 147 |
| PESS-E-L2 | 147 |
| PESS-E-L3 | 147 |
| PESS-E-M | 147 |
| PESS-E-MM | 147 |
| PESS-E-N | 147 |
| PESS-E-NS | 147 |
| PESS-E-PE | 147 |
| PESS-E-PEN | 147 |
| PESS-E-PS | 147 |
| PESS-E-PU | 147 |
| PESS-E-SCH | 147 |
| PESS-E-SG | 147 |
| PESS-E-SS | 147 |
| PESS-E-SU | 147 |
| PESS-E-TE | 147 |
| PESS-E-VDE1 | 177 |
| PESS-E-VDE2 | 177 |
| PESS-E-VDE3 | 177 |
| PESS-SEL | 76 |

PANDUIT® Alphabetical Part Number Index

| Part Number | Page |
|--------------|------|
| PESV-C* | 167 |
| PESV-D* | 167 |
| PESV-E* | 167 |
| PESW-A* | 166 |
| PESW-B* | 166 |
| PESW-C* | 166 |
| PESW-D* | 166 |
| PESW-E* | 166 |
| PESWMS** | 102 |
| PFX-0 | 101 |
| PFX-2 | 101 |
| PJIBM* | 137 |
| PL115-12 | 105 |
| PL130315-2 | 105 |
| PL130315-2P | 105 |
| PL2515-1 | 103 |
| PL2515-2 | 103 |
| PL2515-3 | 103 |
| PL2515-4 | 103 |
| PL2515-5 | 103 |
| PL275115-1 | 103 |
| PL27515-1 | 103 |
| PL27515-3 | 103 |
| PL27515-4 | 103 |
| PL27517-1 | 103 |
| PL2757-1 | 103 |
| PL2757-4 | 103 |
| PL2915-4 | 103 |
| PL2M2S-L | 129 |
| PL315-1 | 103 |
| PL315-4 | 103 |
| PL3215-4 | 103 |
| PL3278-4 | 104 |
| PL329-4 | 104 |
| PL3315-4 | 103 |
| PL3510-1F | 104 |
| PL3510-1F* | 104 |
| PL35115-1 | 103 |
| PL35115-3 | 103 |
| PL3515-1 | 103 |
| PL3515-1R | 105 |
| PL3515-1TB | 104 |
| PL3515-1TG | 104 |
| PL3515-1TP | 104 |
| PL3515-1TRL | 105 |
| PL3515-1TT | 104 |
| PL3515-1TY | 104 |
| PL3515-2 | 103 |
| PL3515-3 | 103 |
| PL3515-3R | 105 |
| PL3515-4 | 103 |
| PL3517-1 | 103 |
| PL3517-3 | 103 |
| PL3517-1TRL | 105 |
| PL357-1 | 103 |
| PL357-2 | 103 |
| PL357-3 | 103 |
| PL3817-1TRL | 105 |
| PL38175-1TRL | 105 |
| PL3M2S-L | 129 |
| PL4115-1 | 103 |
| PL4115-3 | 103 |
| PL415-1 | 103 |
| PL415-2 | 103 |
| PL415-3 | 103 |
| PL417-1 | 103 |
| PL417-1R | 105 |
| PL417-1TB | 104 |
| PL417-1TG | 104 |
| PL417-1TP | 104 |
| PL417-1TRL | 105 |
| PL417-1TT | 104 |

| Part Number | Page |
|-------------|------|
| PL417-1TY | 104 |
| PL417-2 | 103 |
| PL417-3 | 103 |
| PL4175-1TRL | 105 |
| PL4215-1 | 103 |
| PL4215-3 | 103 |
| PL425215-1 | 103 |
| PL427-1 | 103 |
| PL47-1 | 103 |
| PL5115-1 | 103 |
| PL515-1 | 103 |
| PL515-2 | 103 |
| PL517-1 | 103 |
| PL5215-1 | 103 |
| PL5215-2 | 103 |
| PL5315-1 | 103 |
| PL5315-2 | 103 |
| PL57-1 | 103 |
| PL575215-1 | 103 |
| PL6315-1 | 105 |
| PL6315-2 | 105 |
| PL65315-2 | 105 |
| PL77515-1 | 103 |
| PL7757-1 | 103 |
| PLD-1 | 148 |
| PLD-2 | 148 |
| PLD-3 | 173 |
| PLD-4 | 173 |
| PLD-5 | 173 |
| PLD-6 | 173 |
| PLD-7 | 173 |
| PLD-8 | 173 |
| PLD-11 | 173 |
| PLD-12 | 163 |
| PLD-16 | 173 |
| PLD-17 | 173 |
| PLD-18 | 173 |
| PLD-20 | 173 |
| PLD-21 | 173 |
| PLD-22 | 173 |
| PLD-26 | 173 |
| PLD-29 | 173 |
| PLD-30 | 173 |
| PLD-31 | 173 |
| PLD-32 | 163 |
| PLD-33 | 162 |
| PLD-36 | 163 |
| PLD-37 | 163 |
| PLD-38 | 163 |
| PLD-39 | 163 |
| PLD-40 | 163 |
| PLD-42 | 173 |
| PLD-43 | 163 |
| PLD-44 | 163 |
| PLD-45 | 163 |
| PLD-46 | 163 |
| PLD-47 | 163 |
| PLD-48 | 163 |
| PLD-49 | 162 |
| PLD-52 | 163 |
| PLD-53 | 164 |
| PLD-54 | 164 |
| PLD-55 | 173 |
| PLD-56 | 164 |
| PLD-57 | 164 |
| PLD-58 | 162 |
| PLD-59 | 162 |
| PLD-60 | 162 |
| PLD-62 | 178 |
| PLD-63 | 178 |
| PLD-64 | 178 |
| PLD-65 | 178 |

| Part Number | Page |
|----------------|------|
| PLD-67 | 164 |
| PLD-69 | 164 |
| PLD-70 | 164 |
| PLD-71 | 164 |
| PLD-73 | 164 |
| PLD-74 | 164 |
| PLD-75 | 164 |
| PLD-76 | 163 |
| PLD-77 | 178 |
| PLD-78 | 178 |
| PLD-79 | 164 |
| PLD-80 | 164 |
| PLD-81 | 164 |
| PLD-82 | 163 |
| PLD-83 | 165 |
| PLD-84 | 165 |
| PLD-85 | 165 |
| PLD-86 | 165 |
| PLDR-1 | 148 |
| PLDR-2 | 148 |
| PLF1M-C | 129 |
| PLF1MA-C | 129 |
| PLF1MB-C | 129 |
| PLL-1-Y2-10 | 75 |
| PLL-1-Y2Y-10 | 75 |
| PLL-2-Y2-10 | 72 |
| PLL-2-Y2Y-10 | 72 |
| PLL-3-Y3-5 | 70 |
| PLL-4-Y2-10 | 72 |
| PLL-4-Y2Y-10 | 72 |
| PLL-5-Y2-10 | 72 |
| PLL-5-Y2Y-10 | 72 |
| PLL-6-Y2-5 | 72 |
| PLL-6-Y2-10 | 72 |
| PLL-6-Y2Y-5 | 72 |
| PLL-6-Y2Y-10 | 72 |
| PLL-7-Y2-10 | 72 |
| PLL-7-Y2Y-10 | 72 |
| PLL-8-PO-10 | 72 |
| PLL-8-Y2-5 | 72 |
| PLL-8-Y2-10 | 72 |
| PLL-8-Y2Y-5 | 72 |
| PLL-8-Y2Y-10 | 72 |
| PLL-9-POR-10 | 73 |
| PLL-9-Y2-5 | 73 |
| PLL-9-Y2-10 | 73 |
| PLL-9-Y2S-10 | 73 |
| PLL-9-Y2Y-5 | 73 |
| PLL-9-Y2Y-10 | 73 |
| PLL-9-Y3C-5 | 73 |
| PLL-10-Y3-5 | 70 |
| PLL-10-PO-5 | 73 |
| PLL-10-Y3-2.5 | 70 |
| PLL-10-Y3-5 | 70 |
| PLL-10-Y3C-2.5 | 73 |
| PLL-11-Y2-2.5 | 73 |
| PLL-11-Y3-2.5 | 70 |
| PLL-11-Y3*-2.5 | 70 |
| PLL-11-Y3C-2.5 | 73 |
| PLL-12-Y2-1 | 73 |
| PLL-12-Y2-2.5 | 73 |
| PLL-12-Y3-1 | 70 |
| PLL-12-Y3-2.5 | 70 |
| PLL-12-Y3*-2.5 | 70 |
| PLL-13-Y3-1 | 70 |
| PLL-13-Y3-D | 70 |
| PLL-14-PO-5 | 73 |
| PLL-14-POR-5 | 73 |
| PLL-14-Y2-5 | 73 |
| PLL-14-Y2-10 | 73 |
| PLL-14-Y2Y-5 | 73 |
| PLL-15-Y2-5 | 73 |

| Part Number | Page |
|--------------------------------|------|
| PLL-15-Y2-10..... | 73 |
| PLL-15-Y2Y5..... | 73 |
| PLL-16-PO-2.5..... | 73 |
| PLL-16-Y2-2.5..... | 73 |
| PLL-16-Y2-5..... | 73 |
| PLL-16-Y2Y2.5..... | 73 |
| PLL-16-Y2Y5..... | 73 |
| PLL-17-PO-2.5..... | 73 |
| PLL-17-Y2-1..... | 73 |
| PLL-17-Y2-2.5..... | 73 |
| PLL-17-Y2Y2.5..... | 73 |
| PLL-18-Y2-1..... | 74 |
| PLL-18-Y2-1.5..... | 74 |
| PLL-18-Y2Y1..... | 74 |
| PLL-18-Y2Y1.5..... | 74 |
| PLL-19-POR-2.5..... | 74 |
| PLL-19-Y2-1..... | 74 |
| PLL-19-Y2-2.5..... | 74 |
| PLL-19-Y2Y1..... | 74 |
| PLL-19-Y2Y2.5..... | 74 |
| PLL-20-Y2-10..... | 72 |
| PLL-20-Y2Y10..... | 72 |
| PLL-21-Y3-1..... | 70 |
| PLL-22-PO-1..... | 74 |
| PLL-22-PO-1*..... | 74 |
| PLL-22-Y2-1..... | 74 |
| PLL-22-Y3-1..... | 74 |
| PLL-23-Y2-1..... | 72 |
| PLL-23-Y2-5..... | 72 |
| PLL-23-Y3-1..... | 72 |
| PLL-23-Y3-5..... | 72 |
| PLL-24-Y2-1..... | 72 |
| PLL-24-Y2-5..... | 72 |
| PLL-24-Y3-1..... | 72 |
| PLL-24-Y3-5..... | 72 |
| PLL-25-PO-SH..... | 74 |
| PLL-25-POR-SH..... | 74 |
| PLL-25-Y2-SH..... | 74 |
| PLL-25-Y2S-SH..... | 74 |
| PLL-25-Y2Y-SH..... | 74 |
| PLL-25-Y3C-SH..... | 74 |
| PLL-26-Y2-1..... | 74 |
| PLL-27-Y2-1..... | 74 |
| PLL-28-Y2-1..... | 74 |
| PLL-29-Y2-1..... | 74 |
| PLL-30-Y2-10..... | 75 |
| PLL-31-POR-10..... | 72 |
| PLL-31-Y2-10..... | 72 |
| PLL-32-Y2-10..... | 72 |
| PLL-32-Y2Y10..... | 72 |
| PLL-33-PO-5..... | 72 |
| PLL-33-Y3-5..... | 70 |
| PLL-34-POR-10..... | 73 |
| PLL-34-Y2-10..... | 73 |
| PLL-34-Y2Y10..... | 73 |
| PLL-35-PO-2.5..... | 73 |
| PLL-35-POR-2.5..... | 73 |
| PLL-35-Y2S-2.5..... | 73 |
| PLL-36-PO-1..... | 74 |
| PLL-36-POR-1..... | 74 |
| PLL-36-Y2-1..... | 74 |
| PLL-36-Y2S-1..... | 74 |
| PLL-37-Y3-1..... | 70 |
| PLL-38-Y3-1..... | 70 |
| PLL-39-Y3-1..... | 70 |
| PLL-40-Y3-1..... | 70 |
| PLM1M-C..... | 129 |
| PLM2M-C..... | 129 |
| PLM2S-C..... | 129 |
| PLM4S-C..... | 129 |
| PLMA1 through PLMA16..... | 135 |
| PLT1.5I-C through PLT4I-C..... | 154 |

| Part Number | Page |
|--------------------------------|------|
| PLT2S-C through PLT5S-C..... | 152 |
| PM-*..... | 146 |
| PMD..... | 148 |
| PMD-0-9..... | 148 |
| PMD-NEMA..... | 148 |
| PMDR-*..... | 148 |
| PPM-0 through -49..... | 138 |
| PPM-0-9..... | 139 |
| PPM-1-33 through -675-699..... | 138 |
| PPM-1-12..... | 139 |
| PPM-1-18..... | 139 |
| PPM-1-6..... | 139 |
| PPM-220V..... | 145 |
| PPM-A through -Z..... | 140 |
| PPM-A-Z..... | 140 |
| PPM-A1 through -A2..... | 141 |
| PPM-AC..... | 144 |
| PPM-BLK through -YEL..... | 142 |
| PPM-C1 through -C2..... | 141 |
| PPM-DC..... | 144 |
| PPM-F1 through -F3..... | 141 |
| PPM-GND..... | 144 |
| PPM-H1 through -H4..... | 141 |
| PPM-L1 through -L3..... | 141 |
| PPM-MIN..... | 144 |
| PPM-P1 through -P2..... | 141 |
| PPM-PLS..... | 144 |
| PPM-S1 through -S4..... | 141 |
| PPM-T1 through -T4..... | 142 |
| PPM-X1 through -X4..... | 142 |
| PPMCP-*..... | 145 |
| PPS0710****..... | 31 |
| PPS1014****..... | 31 |
| PPS1420****..... | 31 |
| PROG-LITE..... | 30 |
| PROG-WIN2..... | 28 |
| PROG-WIN2CD..... | 28 |
| PRS0710****..... | 31 |
| PRS1014****..... | 31 |
| PRS1420****..... | 31 |
| PSCB-3..... | 136 |
| PSCB-3CAL..... | 171 |
| PSCB-3***..... | 136 |
| PSCB-5..... | 136 |
| PSCB-6..... | 136 |
| PSCB-6CAL..... | 171 |
| PSCB-6***..... | 136 |
| PSCB-12..... | 136 |
| PSCB-13..... | 136 |
| PSCB-16..... | 136 |
| PSCB-BLNK..... | 137 |
| PSCB-COM..... | 137 |
| PSCB-COMS..... | 137 |
| PSCB-D..... | 137 |
| PSCB-DS..... | 137 |
| PSCB-LAN..... | 137 |
| PSCB-V..... | 137 |
| PSCB-VS..... | 137 |
| PSCBF-***..... | 137 |
| PSCC-3..... | 146 |
| PSCC-5..... | 146 |
| PSM-0 through -200..... | 138 |
| PSM-0-9..... | 139 |
| PSM-00 through -09..... | 139 |
| PSM-1-33 through -67-99..... | 138 |
| PSM-1L1 through -4L4..... | 143 |
| PSM-1T1 through -4T3..... | 143 |
| PSM-A through -Z..... | 140 |
| PSM-A-Z..... | 140 |
| PSM-A-Z-0-9..... | 140 |
| PSM-A1 through -A3..... | 141 |
| PSM-D1 through -D5..... | 141 |

| Part Number | Page |
|-------------------------|------|
| PSM-L1 through -L3..... | 141 |
| PSM-SPARE..... | 144 |
| PSM-T1 through -T3..... | 142 |
| PSM-X1 through -X2..... | 142 |
| PST-4 thru -7..... | 32 |
| PST-FO..... | 154 |
| PST-FOBLNK..... | 154 |
| PSWBF-***..... | 137 |
| PSWM-***..... | 146 |
| PSWMH-***..... | 146 |
| PSWMS-****..... | 102 |
| PT-***..... | 154 |
| PTR-CLN..... | 8 |
| PTR1..... | 17 |
| PTR1-AC..... | 17 |
| PTR1-AC220..... | 17 |
| PTR1-RIB..... | 17 |
| PTR1-MAN..... | 17 |
| PTR1-STD..... | 17 |
| PTR2..... | 20 |
| PTR2-RS..... | 20 |
| PTR3..... | 26 |
| PX-0..... | 101 |
| PX-2..... | 101 |
| QL-1***..... | 171 |
| QL-2 through -20..... | 170 |
| QL-21***..... | 171 |
| QLF-***..... | 174 |
| SEZ-ELECKIT1..... | 31 |
| SEZ-PIPEKIT1..... | 31 |
| SEZ-PM..... | 31 |
| SEZ-PMC**..... | 32 |
| SEZ-TAG**..... | 32 |
| SLCT-*..... | 152 |
| SM02W-*..... | 149 |
| SM1W-*..... | 149 |
| SM2W-*..... | 149 |
| SM3W-*..... | 149 |
| SM4W-*..... | 149 |
| SMB02W-*..... | 149 |
| SMB1W-*..... | 149 |
| SMB2W-*..... | 149 |
| SMB3W-*..... | 149 |
| SMB4W-*..... | 149 |
| TTC-CPL-1..... | 40 |
| TTC-DS110-5..... | 40 |
| TTC-EFPL-1..... | 41 |
| TTC-EFPLC-1..... | 41 |
| TTC-EFPL10-1..... | 41 |
| TTC-MJ-5..... | 41 |
| TTC-MJWH-5..... | 41 |
| TTC1Y-10..... | 42 |
| TTC2Y-10..... | 42 |
| TTC3Y-10..... | 42 |
| TTC3YS-10..... | 42 |
| TTC3YST-10..... | 42 |
| TTC4T-10..... | 42 |
| TTC4Y-10..... | 42 |
| TTC4YST-10..... | 42 |
| TTC5T-10..... | 42 |
| TTC5Y-10..... | 42 |
| TTC5YS-10..... | 42 |
| TTC5YST-10..... | 42 |
| TTC6T-10..... | 42 |
| TTC6Y-10..... | 42 |
| TTC7Y-10..... | 42 |
| TTC7YS-10..... | 42 |
| TTC8ET-10..... | 42 |
| TTC8T-10..... | 42 |
| TTC8Y-10..... | 42 |
| TTC8YC-10..... | 42 |
| TTC8YS-10..... | 42 |

PANDUIT® Alphabetical Part Number Index

| Part Number | Page |
|-------------------|------|
| TTC8YST-10..... | 42 |
| TTC9Y-10..... | 42 |
| TTC10T-10..... | 42 |
| TTC10Y-10..... | 42 |
| TTC11Y-10..... | 42 |
| TTC12Y-10..... | 42 |
| TTC13Y-10..... | 42 |
| TTC13YS-10..... | 42 |
| TTC14Y-2.5..... | 42 |
| TTC15P-2.5..... | 42 |
| TTC15Y-2.5..... | 42 |
| TTC16Y-2.5..... | 42 |
| TTC17Y-2.5..... | 42 |
| TTC18Y-2.5..... | 42 |
| TTC19Y-2.5..... | 42 |
| TTC20P-2.5..... | 42 |
| TTC20Y-2.5..... | 42 |
| TTC20YC-2.5..... | 42 |
| TTC20YS-2.5..... | 42 |
| TTC20YST-2.5..... | 42 |
| TTC21P-2.5..... | 42 |
| TTC22P-2.5..... | 43 |
| TTC22Y-2.5..... | 43 |
| TTC22YS-2.5..... | 43 |
| TTC23Y-2.5..... | 43 |
| TTC24P-2.5..... | 43 |
| TTC24Y-2.5..... | 43 |
| TTC24YC-2.5..... | 43 |
| TTC24YS-2.5..... | 43 |
| TTC24YST-2.5..... | 43 |
| TTC25P-1..... | 43 |
| TTC25Y-1..... | 43 |
| TTC25YC-1..... | 43 |
| TTC25YS-1..... | 43 |
| TTC25YST-1..... | 43 |
| TTC26P-1..... | 43 |
| TTC27Y-10..... | 43 |
| TTC28Y-10..... | 43 |
| TTC29Y-5..... | 43 |
| TTC30Y-2.5..... | 43 |
| TTC31P-1..... | 43 |
| TTC31Y-1..... | 43 |
| TTC32P-1..... | 43 |
| TTC32Y-1..... | 43 |
| TTC33P-5..... | 43 |
| TTC34P-5..... | 43 |
| TTC35P-2.5..... | 43 |
| TTC35Y-2.5..... | 43 |
| TTC36P-1..... | 43 |
| TTC36Y-1..... | 43 |
| TTC36YS-1..... | 43 |
| TTC37P-1..... | 43 |
| TTC37Y-1..... | 43 |
| TTC38P-1..... | 43 |
| TTC38Y-1..... | 43 |
| TTC39P-1..... | 43 |
| TTC39Y-1..... | 43 |
| TTC40P-1..... | 43 |
| TTC41P-1..... | 43 |
| TTC41Y-1..... | 43 |
| TTC42P-5..... | 43 |
| TTC42Y-5..... | 43 |
| TTC43P-1..... | 44 |
| TTC43Y-1..... | 44 |
| TTC44P-1..... | 44 |
| TTC44Y-1..... | 44 |
| TTC45Y-1..... | 42 |
| TTC46P-5..... | 43 |
| TTP2-***..... | 21 |
| TTP4-***..... | 21 |
| TTPA2-WHT..... | 21 |
| TTPA4-WHT..... | 21 |

| Part Number | Page |
|--------------------|------|
| TTR-BL..... | 46 |
| TTR-WH..... | 46 |
| TTR2-BL..... | 46 |
| TTR2-WH..... | 46 |
| TTR4-BL-S..... | 46 |
| TTR4-BL-Z..... | 46 |
| TTR4W-BL-S..... | 46 |
| TTR4W-BL-Z..... | 46 |
| TTR6-BL-S..... | 46 |
| TTR6-BL-Z..... | 46 |
| TTR6W-BL-S..... | 46 |
| TTR6W-BL-Z..... | 46 |
| TTRW-BL..... | 46 |
| TTRW2-BL..... | 46 |
| TTSL-*..... | 22 |
| TTSL1VC3-10..... | 44 |
| TTSL2VC3-10..... | 44 |
| TTSL3VC3-1..... | 44 |
| TTSL4VC3-5..... | 44 |
| TTSL6V3-2.5..... | 44 |
| TTSL7VC3-1..... | 44 |
| TTSL8VC3-10..... | 44 |
| TTSL9VC3-10..... | 44 |
| TTSL10VC3-5..... | 44 |
| TTSL247VC3-10..... | 44 |
| TTSL250VC3-10..... | 44 |
| TTV2-***..... | 21 |
| TTV4-***..... | 21 |
| WL1..... | 162 |
| WL3..... | 162 |
| WL25..... | 163 |
| WL32..... | 163 |
| WL33..... | 163 |
| WL35..... | 165 |
| WL36..... | 165 |



Компания «ЭлектроПласт» предлагает заключение долгосрочных отношений при поставках импортных электронных компонентов на взаимовыгодных условиях!

Наши преимущества:

- Оперативные поставки широкого спектра электронных компонентов отечественного и импортного производства напрямую от производителей и с крупнейших мировых складов;
- Поставка более 17-ти миллионов наименований электронных компонентов;
- Поставка сложных, дефицитных, либо снятых с производства позиций;
- Оперативные сроки поставки под заказ (от 5 рабочих дней);
- Экспресс доставка в любую точку России;
- Техническая поддержка проекта, помощь в подборе аналогов, поставка прототипов;
- Система менеджмента качества сертифицирована по Международному стандарту ISO 9001;
- Лицензия ФСБ на осуществление работ с использованием сведений, составляющих государственную тайну;
- Поставка специализированных компонентов (Xilinx, Altera, Analog Devices, Intersil, Interpoint, Microsemi, Aeroflex, Peregrine, Syfer, Eurofarad, Texas Instrument, Miteq, Cobham, E2V, MA-COM, Hittite, Mini-Circuits, General Dynamics и др.);

Помимо этого, одним из направлений компании «ЭлектроПласт» является направление «Источники питания». Мы предлагаем Вам помощь Конструкторского отдела:

- Подбор оптимального решения, техническое обоснование при выборе компонента;
- Подбор аналогов;
- Консультации по применению компонента;
- Поставка образцов и прототипов;
- Техническая поддержка проекта;
- Защита от снятия компонента с производства.



Как с нами связаться

Телефон: 8 (812) 309 58 32 (многоканальный)

Факс: 8 (812) 320-02-42

Электронная почта: org@eplast1.ru

Адрес: 198099, г. Санкт-Петербург, ул. Калинина, дом 2, корпус 4, литера А.