

Wet Tantalum SMD Capacitors, Tantalum Metal Case with Glass-to-Tantalum Hermetic Seal

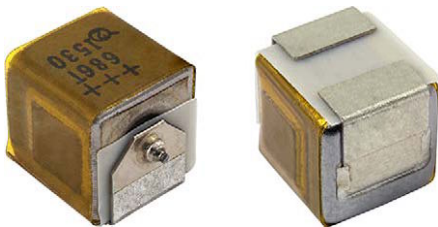

PERFORMANCE CHARACTERISTICS

Operating Temperature: -55 °C to +85 °C
(to +125 °C with voltage derating)

DC Leakage Current (DCL Max.): at +25 °C and above: leakage current shall not exceed the values listed in the Standard Ratings table.

Capacitance Range: 10 µF to 68 µF

Capacitance Tolerance: ± 10 %, ± 20 % standard

Voltage Rating: 50 V_{DC} to 125 V_{DC}

FEATURES

- Enhanced performance, high reliability design
- SMD, standard tin / lead (Sn / Pb), 100 % tin (RoHS-compliant) available
- Mounting: surface-mount
- Increased thermal shock capability of 300 cycles
- Designed for the avionics and aerospace applications
- Material categorization: for definitions of compliance please see www.vishay.com/doc?99912



Available

RoHS*
Available

HALOGEN

FREE
GREEN

(5-2008)

Available

Note

* This datasheet provides information about parts that are RoHS-compliant and / or parts that are non-RoHS-compliant. For example, parts with lead (Pb) terminations are not RoHS-compliant. Please see the information / tables in this datasheet for details.

ORDERING INFORMATION							
T22	C	686	K	050	E	S	S
TYPE	CASE CODE	CAPACITANCE	CAPACITANCE TOLERANCE	DC VOLTAGE RATING AT +85 °C	TERMINATION / PACKAGING	RELIABILITY GRADE	ESR
	See Ratings and Case Codes table	This is expressed in picofarads. The first two digits are the significant figures. The third is the number of zeros to follow.	K = ± 10 % M = ± 20 %	This is expressed in volts. To complete the three-digit block, zeros precede the voltage rating. A decimal point is indicated by an "R" (6R3 = 6.3 V).	E = Sn / Pb solder / 7" (178 mm) reel L = Sn / Pb solder / 7" (178 mm), 1/2 reel C = 100 % tin / 7" (178 mm), reel H = 100 % tin / 7" (178 mm), 1/2 reel R = Sn / Pb solder / 7" (178 mm), partial reel U = 100 % tin / 7" (178 mm), partial reel	S = 48 h burn-in Z = non-established reliability	S = standard

DIMENSIONS in inches [millimeters]					
CASE CODE	L	W	H	P	Tw
C	0.354 max. [9 max.]	0.279 ± 0.008 [7.1 ± 0.2]	0.291 ± 0.008 [7.4 ± 0.2]	0.098 ± 0.008 [2.5 ± 0.2]	0.197 ± 0.008 [5.0 ± 0.2]

MARKING	
	VOLTAGE CODE
	V
	CODE
	50
	75
100	
125	

STANDARD RATINGS											
CAPACITANCE AT +25 °C 120 Hz (μ F)	CASE CODE	PART NUMBER	MAX. ESR AT +25 °C 120 Hz (Ω)	MAX. IMP. AT -55 °C 120 Hz (Ω)	MAX. DCL (μ A) AT		MAX. CAPACITANCE CHANGE (%)			AC RIPPLE +85 °C 40 kHz (mArms)	
					+25 °C	+85 °C AND +125 °C	-55 °C	+85 °C	+125 °C		
50 V_{DC} AT +85 °C; 30 V_{DC} AT +125 °C											
68	C	T22C686(1)050(2)(3)(4)	1.50	35	1	5	-25	8	15	1650	
75 V_{DC} AT +85 °C; 50 V_{DC} AT +125 °C											
33	C ⁽¹⁾	T22C336(1)075(2)(3)(4)	2.50	66	1	5	-25	5	9	1310	
100 V_{DC} AT +85 °C; 65 V_{DC} AT +125 °C											
15	C ⁽¹⁾	T22C156(1)100(2)(3)(4)	3.50	125	1	5	-18	3	10	1030	
125 V_{DC} AT +85 °C; 85 V_{DC} AT +125 °C											
10	C	T22C106(1)125(2)(3)(4)	5.50	175	1	5	-15	3	10	832	

Notes

- Part number definitions:
 - Capacitance tolerance: K, M
 - Termination and packaging: C, H, E, L, R, U
 - Reliability level: Z, S
 - ESR: S
- ⁽¹⁾ Rating in development, contact factory for availability

POWER DISSIPATION	
CASE CODE	MAXIMUM PERMISSIBLE POWER DISSIPATION AT +25 °C (W) IN FREE AIR
C	0.9

STANDARD PACKAGING QUANTITY			
CASE CODE	UNITS PER REEL		
	7" FULL REEL	7" HALF REEL	7" PARTIAL REEL
C	100	50	25

TAPE AND REEL PACKAGING in inches [millimeters]

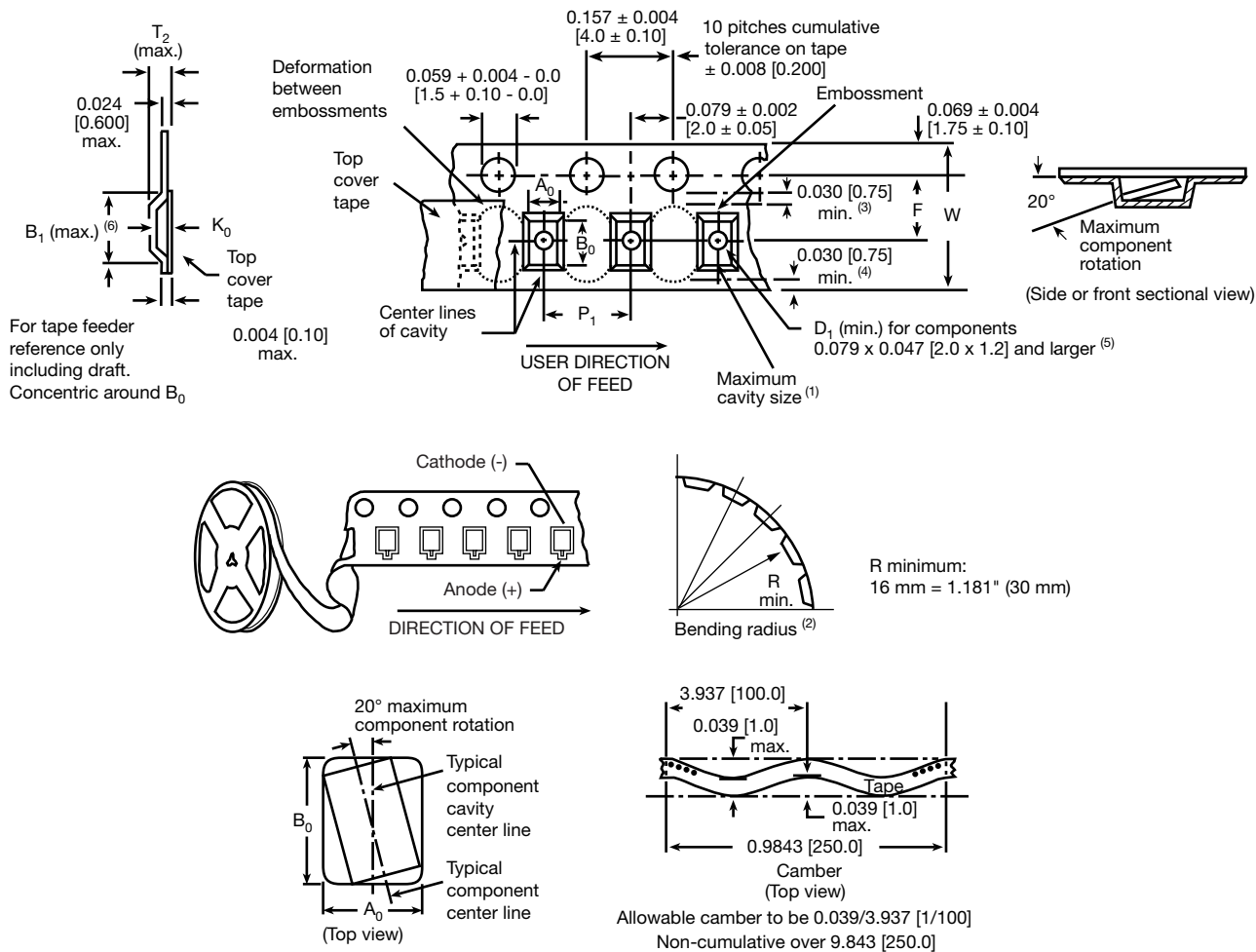

Notes

- Metric dimensions will govern. Dimensions in inches are rounded and for reference only.
- (1) A_0 , B_0 , K_0 , are determined by the maximum dimensions to the ends of the terminals extending from the component body and / or the body dimensions of the component. The clearance between the ends of the terminals or body of the component to the sides and depth of the cavity (A_0 , B_0 , K_0) must be within 0.002" (0.05 mm) minimum and 0.020" (0.50 mm) maximum. The clearance allowed must also prevent rotation of the component within the cavity of not more than 20°.
- (2) Tape with components shall pass around radius "R" without damage. The minimum trailer length may require additional length to provide "R" minimum for 12 mm embossed tape for reels with hub diameters approaching N minimum.
- (3) This dimension is the flat area from the edge of the sprocket hole to either outward deformation of the carrier tape between the embossed cavities or to the edge of the cavity whichever is less.
- (4) This dimension is the flat area from the edge of the carrier tape opposite the sprocket holes to either the outward deformation of the carrier tape between the embossed cavity or to the edge of the cavity whichever is less.
- (5) The embossed hole location shall be measured from the sprocket hole controlling the location of the embossement. Dimensions of embossement location shall be applied independent of each other.
- (6) B_1 dimension is a reference dimension tape feeder clearance only.

CARRIER TAPE DIMENSIONS in inches [millimeters]

TAPE WIDTH	W	P ₂	F	E ₁	E ₂ MIN.
16 mm	0.630 + 0.012 / - 0.004 [16.0 + 0.3 / - 0.1]	0.079 ± 0.004 [2.0 ± 0.1]	0.295 ± 0.004 [7.5 ± 0.1]	0.069 ± 0.004 [1.75 ± 0.1]	0.561 [14.25]

CARRIER TAPE DIMENSIONS in inches [millimeters]					
TYPE	CASE CODE	TAPE WIDTH W (mm)	P ₁	K ₀ MAX.	B ₁ MAX.
T22	C	16	0.476 ± 0.004 [12.0 ± 0.1]	0.31 [7.9]	0.45 [11.3]

RECOMMENDED REFLOW PROFILES

Capacitors should withstand reflow profile as per J-STD-020 standard

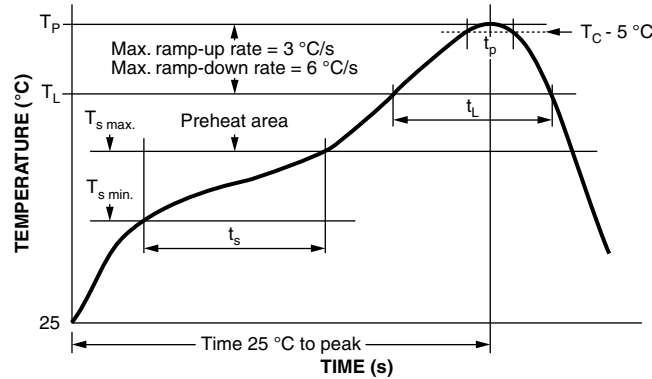

PROFILE FEATURE	SnPb EUTECTIC ASSEMBLY	LEAD (Pb)-FREE ASSEMBLY
Preheat / soak		
Temperature min. (T _{s min.})	100 °C	150 °C
Temperature max. (T _{s max.})	150 °C	200 °C
Time (t _s) from (T _{s min.} to T _{s max.})	60 s to 120 s	60 s to 120 s
Ramp-up		
Ramp-up rate (T _L to T _P)	3 °C/s max.	3 °C/s max.
Liquidus temperature (T _L)	183 °C	217 °C
Time (t _L) maintained above T _L	60 s to 150 s	60 s to 150 s
Peak package body temperature (T _P)	220	245
Time (t _p) within 5 °C of the specified classification temperature (T _C)	20 s	30 s
Time 25 °C to peak temperature	6 min max.	8 min max.
Ramp-down		
Ramp-down rate (T _P to T _L)	6 °C/s max.	6 °C/s max.
Time 25 °C to peak temperature	6 min max.	8 min max.

PAD DIMENSIONS in inches [millimeters]

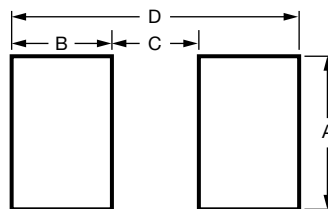

CASE CODE	A (MIN.)	B (NOM.)	C (NOM.)	D (NOM.)
C	0.295 [7.50]	0.138 [3.50]	0.100 [2.50]	0.374 [9.50]

**TYPICAL PERFORMANCE CHARACTERISTICS OF T22 CAPACITORS**

ELECTRICAL PERFORMANCE CHARACTERISTICS			
ITEM	PERFORMANCE CHARACTERISTICS		
Category temperature range	-55 °C to +85 °C (to +125 °C with voltage derating)		
Capacitance tolerance	± 20 %, ± 10 % at +25 °C, 120 Hz		
Capacitance change by temperature	Limit per Standard Ratings table		
ESR	Limit per Standard Ratings table, at +25 °C, 120 Hz		
Impedance	Limit per Standard Ratings table, at -55 °C, 120 Hz		
DCL (leakage current)	Limit per Standard Ratings table		
AC ripple current	Limit per Standard Ratings table, at +85 °C and 40 kHz		
Reverse voltage	Reverse voltage shall be in accordance with MIL-PRF-39006, paragraphs 3.23 and 4.8.19, except DC potential will be maximum of 3 V		
Maximum operating voltage	OPERATING TEMPERATURE		
	+85 °C		+125 °C
	RATED VOLTAGE (V_{DC})	SURGE VOLTAGE (V_{DC})	DERATED VOLTAGE (V_{DC})
	50	57.5	30
	75	86.2	50
	100	115.0	65
125	144.0	85	
Surge voltage	The DC surge voltage is the maximum voltage to which the capacitor can be subjected under any conditions including transients and peak ripple at the highest line voltage. The DC surge voltage is 115 % of rated DC voltage		

PERFORMANCE CHARACTERISTICS			
ITEM	CONDITION	POST TEST PERFORMANCE	
Surge voltage	In accordance with MIL-PRF-39006: 85 °C 1000 successive test cycles at the applicable DC surge voltage specified in series with a 1 kΩ resistor at the rate of 30 s ON, 5.5 min OFF	Capacitance change Leakage current	Within ± 10 % of initial measured value Not to exceed specified value
Life testing	In accordance with MIL-PRF-39006: capacitors shall be capable of withstanding a 2000 h life test at a temperature +85 °C at rated voltage, or a 2000 h life test at a temperature +125 °C at derated voltage	Capacitance change Leakage current at 85 °C / 125 °C Leakage current at 25 °C ESR	+10 % / -20 % of initial measured value Not to exceed 125 % of initial specified value Not to exceed specified value Not to exceed 200 % of specified value
AC ripple life	In accordance with MIL-PRF-39006: 2000 h, +85 °C		



ENVIRONMENTAL CHARACTERISTICS		
ITEM	CONDITION	POST TEST PERFORMANCE
Stability at low and high temperatures	As specified in MIL-PRF-39006	The capacitors shall meet the requirements of MIL-PRF-39006
Seal	MIL-PRF-39006 Method 112 of MIL-STD-202, conditions A and C	When the capacitors are tested as specified in MIL-PRF-39006, there shall be no evidence of leakage.
Moisture resistance	MIL-PRF-55365 Method 106 of MIL-STD-202, number of cycles: 10 continuous cycles except that steps 7a and 7b shall be omitted.	DC leakage Capacitance change ESR Not exceed 125 % of the specified value Within ±10 % of the initial measured value Not exceed the specified value
Barometric pressure (reduced)	Method 105 of MIL-STD-202, condition E (150 000 feet) (45,720.1 m).	There shall be no mechanical or visual damage to capacitors post-conditioning.
Low temperature storage	MIL-PRF-39006 Method 502 of MIL-STD-810, Storage temperature: - 62 °C + 0 °C, - 3 °C Exposure time: 72 h followed by a 1 h exposure at + 125 °C + 7 °C, - 0 °C within 24 h after low temperature storage.	DC leakage Capacitance change ESR Not to exceed 125 % of the specified value Within ± 10 % of the initial measured value Not exceed the specified value
Salt atmosphere (corrosion)	MIL-PRF-39006 Method 101 of MIL-STD-202, condition B (48 h), applicable salt solution: 5 %	There shall be no harmful corrosion. Marking shall remain legible.

MECHANICAL PERFORMANCE CHARACTERISTICS		
ITEM	CONDITION	POST TEST PERFORMANCE
Shear test	AEC-Q200-006 Apply a pressure load of 5 N for 10 s ± 1 s horizontally to the center of capacitor side body.	DC leakage Capacitance change ESR Not to exceed 125 % of the specified value Within ± 10 % of the initial measured value Not exceed the specified value There shall be no mechanical or visual damage to capacitors post-conditioning.
Solderability	MIL-STD-202, method 208, test B ANSI/J-STD-002: SnPb solder - test B Pb-free solder - test B1	All terminations shall exhibit a continuous solder coating free from defects for a minimum of 95 % of the critical area of any individual lead.
Resistance to solvent	MIL-STD-202, method 215	There shall be no mechanical or visual damage to capacitors post-conditioning. Marking shall remain legible, no degradation of the can material.
Insulation resistance	Method 302 of MIL-STD-202, condition B (500 V _{DC} ± 10 %)	The insulation resistance shall be not less than 100 MΩ. The capacitors shall meet the requirements of MIL-PRF-39006.
Shock (specified pulse)	MIL-STD-202, method 213, condition I (100 g)	The capacitors shall meet the requirements of MIL-PRF-39006.
Vibration, high frequency	MIL-STD-202, method 204, condition E (50 g peak)	The capacitors shall meet the requirements of MIL-PRF-39006.
Random vibration	MIL-STD-202, method 214, condition II-G (overall RMS 27.78 G)	The capacitors shall meet the requirements of MIL-PRF-39006.
Thermal shock	MIL-STD-202, method 107, condition A	Thermal shock shall be in accordance with MIL-PRF-39006 when tested for 300 cycles.
Resistance to soldering heat	MIL-STD-202, method 210, condition J, except with only one heat cycle	Capacitance change ESR Leakage current Within ± 10 % of initial Initial specified value or less Initial specified value or less There shall be no mechanical or visual damage to capacitors post-conditioning.

TYPICAL CURVES OF IMPEDANCE AS A FUNCTION OF FREQUENCY AT VARIOUS TEMPERATURES

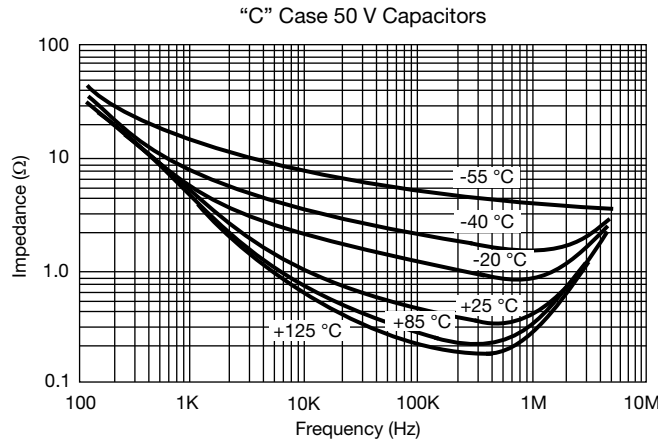

PERFORMANCE CHARACTERISTICS

- Operating Temperature:** capacitors are designed to operate over a temperature range of -55 °C to +125 °C.

UP TO +85 °C (V)	AT +125 °C (V)
50	30
75	50
100	65
125	85

- DC Working Voltage:** the DC working voltage is the maximum operating voltage for continuous duty at the rated temperature.
- Surge Voltage:** the surge voltage rating is the maximum voltage to which the capacitors should be subjected under any conditions. This includes transients and peak ripple at the highest line voltage.
 - The surge voltage of capacitors is 115 % of rated DC working voltage.
 - Surge Voltage Test:** capacitors shall withstand the surge voltage applied through a 1000 Ω ± 10 % resistor in series with the capacitor and voltage source at the rate of one-half minute on, five and one-half minutes off, for 1000 successive test cycles at +85 °C.
 - Following the surge voltage test, the capacitance at +25 °C shall not have changed by more than ± 10 % and the equivalent series resistance and DC leakage current will not exceed the values shown in the Standard Ratings table for each capacitor.
- Capacitance Tolerance:** the capacitance of all capacitors shall be within the specified tolerance limits of the nominal rating.
 - Measurements shall be made by the bridge method at or referred to a frequency of 120 Hz at a temperature of +25 °C. The maximum voltage applied to the capacitors during measurement shall be 1 V_{RMS}. Measurement accuracy of the bridge shall be within ± 2 %.
- Capacitance Change With Temperature:** the capacitance change with temperature shall not exceed the values given in the Standard Ratings table for each capacitor.

- Equivalent Series Resistance:** measurements shall be made by the bridge method at, or referred to, a frequency of 120 Hz at a temperature of +25 °C. A maximum of 1 V_{RMS} shall be applied during measurement.

- The equivalent series resistance shall not exceed the maximum value in ohms listed in the Standard Ratings table for each capacitor.
- The dissipation factor may be calculated from the equivalent series resistance and capacitance values as shown:

$$DF = \frac{2\pi fRC}{10^4}$$

where:

DF = dissipation factor in %

R = ESR in Ω

C = capacitance in μF

f = frequency in Hz

At 120 Hz, the above equation becomes:

$$DF = \frac{R \times C}{13.26}$$

For example, percent dissipation factor of a 30 μF, 6 V capacitor, which has a maximum ESR of 4.0 Ω at +25 °C and 120 Hz, would be calculated as shown:

$$DF = \frac{2\pi \times 120 \times 4 \times 30}{10^4} = \frac{4 \times 30}{13.26} = 9.05 \%$$

- Leakage Current:** measurements shall be made at the applicable rated working voltage at +25 °C ± 5 °C through application of a steady source of power, such as a regulated power supply. A 1000 Ω resistor to limit the charging current shall be connected in series with each capacitor under test. Rated working voltage shall be applied to capacitors for 5 minutes before making leakage current measurements.

7.1 The maximum leakage current for any capacitor shall not exceed the maximum value in μA listed in the Standard Ratings table for each capacitor.

Note

- Leakage current varies with applied voltage. See graph next column for the appropriate adjustment factor

8. **Low Temperature Impedance:** the impedance of any capacitor at $-55\text{ }^\circ\text{C}$ at 120 Hz, shall not exceed the values given in the Standard Ratings table.

9. **Life Test:** capacitors are capable of withstanding a 2000 h life test at a temperature of $+85\text{ }^\circ\text{C}$ or $+125\text{ }^\circ\text{C}$ at the applicable rated DC working voltage.

9.1 Following the life test, the capacitors shall be returned to $25\text{ }^\circ\text{C} \pm 5\text{ }^\circ\text{C}$. The leakage current, measured at the $+85\text{ }^\circ\text{C}$ rated voltage, shall not be in excess of the original requirement; the capacitance value shall not exceed 150 % of the initial requirement; the capacitance value shall not change more than $+10\text{ } \%$ / $-20\text{ } \%$ from the initial measurement.

10. **Ripple Life Test at $+85\text{ }^\circ\text{C}$:** capacitors shall be tested in accordance with military specification MIL-PRF-39006 except that:

- Operation conditions: this test shall be run at a frequency of $40\text{ kHz} \pm 2\text{ kHz}$ sinusoidal and at the RMS ripple current levels specified in the Standard Ratings table.
- Applied DC voltage shall be reduced so that the peak AC voltage plus DC voltage shall not exceed the rated voltage of the capacitor in either the forward or reverse direction.

10.1 When tested as specified above, capacitors shall meet the following requirements:

- The DC leakage current at $+25\text{ }^\circ\text{C}$ and at $+85\text{ }^\circ\text{C}$ shall not exceed the original requirements.
- The capacitance shall not change more than $\pm 15\text{ } \%$ from the initial measured value.
- The dissipation factor shall not exceed the original requirements.
- Visual examination: There shall be no damage, obliteration of marking or leakage of electrolyte.

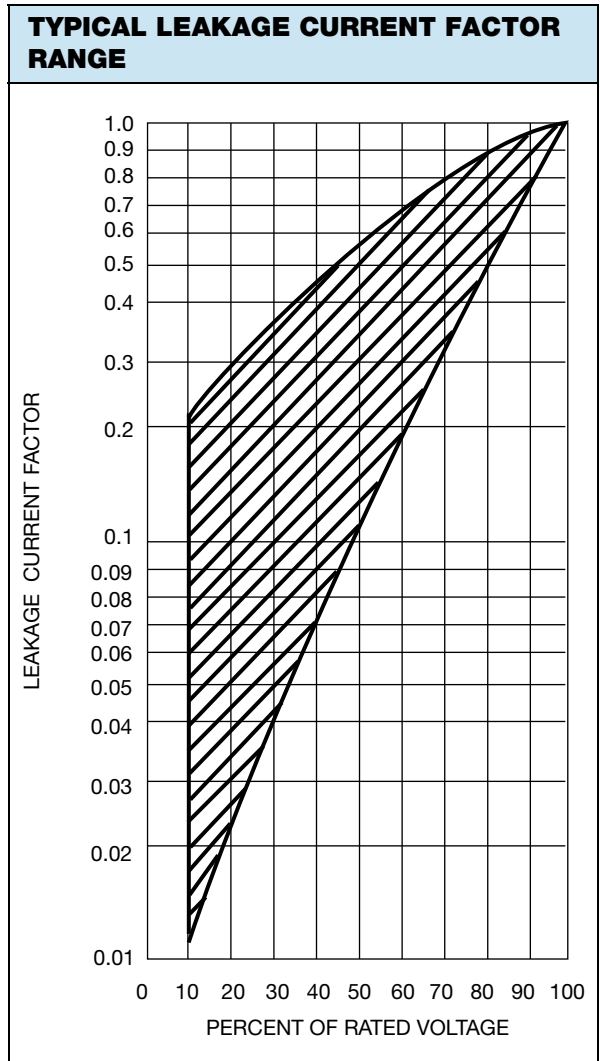

GUIDE TO APPLICATION

1. **AC Ripple Current:** subjecting a capacitor to an AC voltage causes an AC current to flow through it. The amplitude of the current is dependent on the impedance of the capacitor at the frequency of the applied signal:

$$I = \frac{V}{Z}$$

where:

I = ripple current

V = applied AC voltage

Z = impedance of capacitor (frequency dependent)

This current causes heating in the capacitor because of I^2R losses (R is the equivalent series resistance at the applied frequency). This heating or power dissipation, is one of the limiting factors of the capacitor's ripple current rating.

These power dissipation ratings are based on a calculated $+50\text{ }^\circ\text{C}$ internal temperature rise in still air. The maximum allowable ripple currents given in the Standard Ratings table are based on these ratings and the maximum equivalent series resistance at that frequency.

The relationship is written as follows:

$$P = I^2R$$

where:

P = maximum power

I = maximum ripple current

R = equivalent series resistance

Therefore:

$$I = \sqrt{\frac{P}{R}}$$

where:

R is in Ω

P is in W

I is in A_{RMS}

2. **AC Ripple Voltage:** in operation, the peak voltage across the capacitor (DC working voltage plus peak ripple voltage) must not exceed the rated working voltage of the capacitor. The DC component of the applied voltage should be sufficiently large to prevent polarity reversal in excess of 3 V at +85 °C or 2 V at 125 °C.

There will be a point at the lower frequency and capacitance values when the peak AC voltage will be the limiting factor on the ripple current - not its heating effects.

3. **Ripple Current Multipliers:** the Standard Ratings table list the maximum permissible RMS ripple current at 40 kHz for each rating. These values are based on the maximum power dissipation allowed at that frequency.

This ripple current, will cause heating, which adds to the ambient temperature. The higher ambient temperatures, voltage derating or current derating is required (see "Ripple Current Multipliers" table). Also shown are the multipliers for ripple currents at various frequencies, caused by the frequency dependence of the (ESR) equivalent series resistance. (see "Typical ESR as a Function of Frequency" chart)

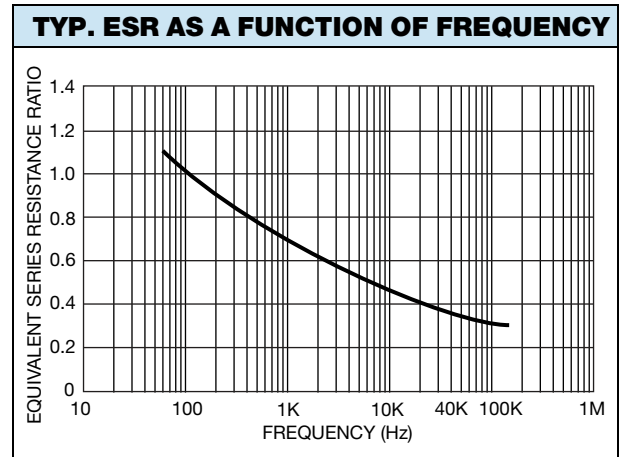

RIPPLE CURRENT MULTIPLIERS VS. FREQUENCY, TEMPERATURE AND APPLIES PEAK VOLTAGE																									
FREQUENCY OF APPLIED RIPPLE CURRENT		120 Hz				800 Hz				1 kHz				10 kHz				40 kHz				100 kHz			
		≤ 55	85	105	125	≤ 55	85	105	125	≤ 55	85	105	125	≤ 55	85	105	125	≤ 55	85	105	125	≤ 55	85	105	125
% of 85 °C rated peak voltage	100 %	0.60	0.39	-	-	0.71	0.43	-	-	0.72	0.46	-	-	0.88	0.55	-	-	1.0	0.63	-	-	1.1	0.69	-	-
	90 %	0.60	0.46	-	-	0.71	0.55	-	-	0.72	0.55	-	-	0.88	0.67	-	-	1.0	0.77	-	-	1.1	0.85	-	-
	80 %	0.60	0.52	0.35	-	0.71	0.62	0.42	-	0.72	0.62	0.42	-	0.88	0.76	0.52	-	1.0	0.87	0.59	-	1.1	0.96	0.65	-
	70 %	0.60	0.58	0.44	-	0.71	0.69	0.52	-	0.72	0.70	0.52	-	0.88	0.85	0.64	-	1.0	0.97	0.73	-	1.1	1.07	0.80	-
	66 2/3 %	0.60	0.60	0.46	0.27	0.71	0.71	0.55	0.32	0.72	0.72	0.55	0.32	0.88	0.88	0.68	0.40	1.0	1.0	0.77	0.45	1.1	1.1	0.85	0.50



Disclaimer

ALL PRODUCT, PRODUCT SPECIFICATIONS AND DATA ARE SUBJECT TO CHANGE WITHOUT NOTICE TO IMPROVE RELIABILITY, FUNCTION OR DESIGN OR OTHERWISE.

Vishay Intertechnology, Inc., its affiliates, agents, and employees, and all persons acting on its or their behalf (collectively, "Vishay"), disclaim any and all liability for any errors, inaccuracies or incompleteness contained in any datasheet or in any other disclosure relating to any product.

Vishay makes no warranty, representation or guarantee regarding the suitability of the products for any particular purpose or the continuing production of any product. To the maximum extent permitted by applicable law, Vishay disclaims (i) any and all liability arising out of the application or use of any product, (ii) any and all liability, including without limitation special, consequential or incidental damages, and (iii) any and all implied warranties, including warranties of fitness for particular purpose, non-infringement and merchantability.

Statements regarding the suitability of products for certain types of applications are based on Vishay's knowledge of typical requirements that are often placed on Vishay products in generic applications. Such statements are not binding statements about the suitability of products for a particular application. It is the customer's responsibility to validate that a particular product with the properties described in the product specification is suitable for use in a particular application. Parameters provided in datasheets and/or specifications may vary in different applications and performance may vary over time. All operating parameters, including typical parameters, must be validated for each customer application by the customer's technical experts. Product specifications do not expand or otherwise modify Vishay's terms and conditions of purchase, including but not limited to the warranty expressed therein.

Except as expressly indicated in writing, Vishay products are not designed for use in medical, life-saving, or life-sustaining applications or for any other application in which the failure of the Vishay product could result in personal injury or death. Customers using or selling Vishay products not expressly indicated for use in such applications do so at their own risk. Please contact authorized Vishay personnel to obtain written terms and conditions regarding products designed for such applications.

No license, express or implied, by estoppel or otherwise, to any intellectual property rights is granted by this document or by any conduct of Vishay. Product names and markings noted herein may be trademarks of their respective owners.

Material Category Policy

Vishay Intertechnology, Inc. hereby certifies that all its products that are identified as RoHS-Compliant fulfill the definitions and restrictions defined under Directive 2011/65/EU of The European Parliament and of the Council of June 8, 2011 on the restriction of the use of certain hazardous substances in electrical and electronic equipment (EEE) - recast, unless otherwise specified as non-compliant.

Please note that some Vishay documentation may still make reference to RoHS Directive 2002/95/EC. We confirm that all the products identified as being compliant to Directive 2002/95/EC conform to Directive 2011/65/EU.

Vishay Intertechnology, Inc. hereby certifies that all its products that are identified as Halogen-Free follow Halogen-Free requirements as per JEDEC JS709A standards. Please note that some Vishay documentation may still make reference to the IEC 61249-2-21 definition. We confirm that all the products identified as being compliant to IEC 61249-2-21 conform to JEDEC JS709A standards.



Компания «ЭлектроПласт» предлагает заключение долгосрочных отношений при поставках импортных электронных компонентов на взаимовыгодных условиях!

Наши преимущества:

- Оперативные поставки широкого спектра электронных компонентов отечественного и импортного производства напрямую от производителей и с крупнейших мировых складов;
- Поставка более 17-ти миллионов наименований электронных компонентов;
- Поставка сложных, дефицитных, либо снятых с производства позиций;
- Оперативные сроки поставки под заказ (от 5 рабочих дней);
- Экспресс доставка в любую точку России;
- Техническая поддержка проекта, помощь в подборе аналогов, поставка прототипов;
- Система менеджмента качества сертифицирована по Международному стандарту ISO 9001;
- Лицензия ФСБ на осуществление работ с использованием сведений, составляющих государственную тайну;
- Поставка специализированных компонентов (Xilinx, Altera, Analog Devices, Intersil, Interpoint, Microsemi, Aeroflex, Peregrine, Syfer, Eurofarad, Texas Instrument, Miteq, Cobham, E2V, MA-COM, Hittite, Mini-Circuits, General Dynamics и др.);

Помимо этого, одним из направлений компании «ЭлектроПласт» является направление «Источники питания». Мы предлагаем Вам помощь Конструкторского отдела:

- Подбор оптимального решения, техническое обоснование при выборе компонента;
- Подбор аналогов;
- Консультации по применению компонента;
- Поставка образцов и прототипов;
- Техническая поддержка проекта;
- Защита от снятия компонента с производства.



Как с нами связаться

Телефон: 8 (812) 309 58 32 (многоканальный)

Факс: 8 (812) 320-02-42

Электронная почта: org@eplast1.ru

Адрес: 198099, г. Санкт-Петербург, ул. Калинина, дом 2, корпус 4, литера А.