



MIC69301/2/3

Single Supply V_{IN} , Low V_{IN} , Low V_{OUT} , 3A
LDO

General Description

The MIC69301/2/3 is the 3A output current member of the MIC69xxx family of high current, low voltage regulators, which support currents of 1A, 1.5A, 3A, and 5A. This family operates from a single low voltage supply, yet offers high precision and ultra low dropout of 500mV under worst case conditions.

The MIC69301/2/3 operates from an input voltage of 1.65V to 5.5V. It is designed to drive digital circuits requiring low voltage at high currents (i.e., PLDs, DSP, microcontroller, etc.). These regulators are available in adjustable and fixed output voltages. The adjustable version can support output voltages down to 0.5V.

The μ Cap design of the MIC69301/2/3 is optimized for stability with low value, low-ESR ceramic output capacitors.

Features of the MIC69301/2/3 include thermal shutdown and current limit protection. Logic enable and error flag pins are also available.

The MIC69301/2/3 is offered in TO-263, S-PAK and the ePad SOIC-8 packages. The MIC69303 is also available in a 12-Pin 4mm x 4mm MLF™ package. All packages have an operating temperature range of -40°C to $+125^{\circ}\text{C}$.

Datasheets and support documentation can be found on Micrel's web site at: www.micrel.com.

Features

- Input voltage range: V_{IN} : 1.65V to 5.5V
- Maximum dropout ($V_{IN} - V_{OUT}$) of 500mV over temperature
- Adjustable output voltage down to 0.5V
- Stable with 10 μ F ceramic output capacitor
- Excellent line and load regulation
- Logic controlled shutdown
- Thermal shutdown and current-limit protection
- Error flag output
- 5-Pin TO-263
- 5-Pin S-Pak package
- ePad SOIC-8 package
- 12-Pin 4mm x 4mm MLF™ package (MIC69303 only)
- -40°C to $+125^{\circ}\text{C}$ junction temperature range

Applications

- Point-of-load applications
- Industrial power
- Sensitive RF applications

Typical Application

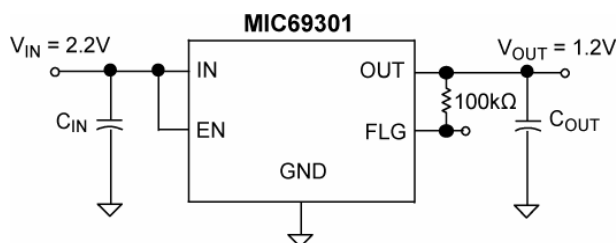

Fixed 1.2V Regulator w/Error Flag Output

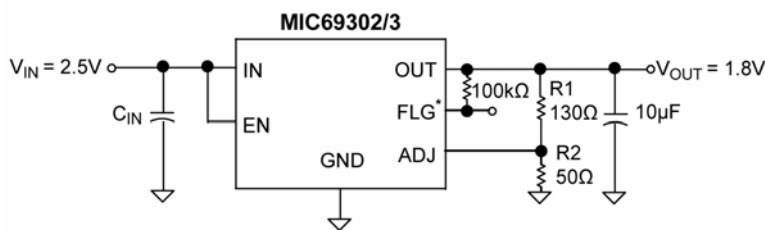

*Error Flag Output MIC69303 only

Adjustable Regulator

MLF and MicroLeadFrame are registered trademarks of Amkor Technologies, Inc.

Micrel Inc. • 2180 Fortune Drive • San Jose, CA 95131 • USA • tel +1 (408) 944-0800 • fax +1 (408) 474-1000 • <http://www.micrel.com>

Ordering Information

Part Number	Nominal Output Voltage	Flag Output	Junction Temperature Range	Package	Lead Finish
MIC69301-1.2YME	1.2V	Yes	-40° to +125°C	8-Pin ePad SOIC	Pb Free
MIC69301-1.2WR	1.2V	Yes	-40° to +125°C	5-Pin S-PAK	RoHS Compliant
MIC69301-1.2WU	1.2V	Yes	-40° to +125°C	5-Pin TO-263	RoHS Compliant
MIC69302WR	Adj.	No	-40° to +125°C	5-Pin S-PAK	RoHS Compliant
MIC69302WU	Adj.	No	-40° to +125°C	5-Pin TO-263	RoHS Compliant
MIC69303YME	Adj.	Yes	-40° to +125°C	8-Pin ePad SOIC	Pb Free
MIC69303YML	Adj.	Yes	-40° to +125°C	12-Pin 4mm x 4mm MLF™	Pb Free

Pin Configuration

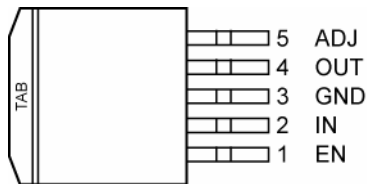

5-Pin TO-263 (U)
(Adjustable Voltage)

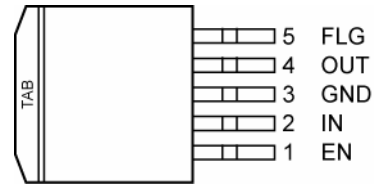

5-Pin TO-263 (U)
(Fixed Voltage with Flag)

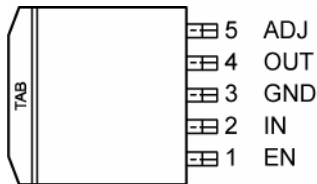

5-Pin S-PAK (R)
(Adjustable Voltage)

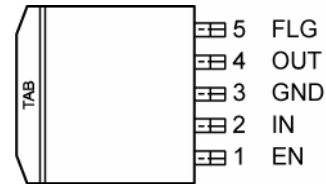

5-Pin S-PAK (R)
(Fixed Voltage with Flag)

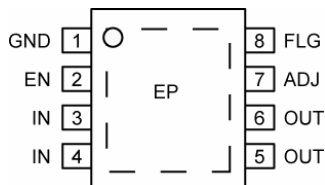

8-Pin ePad SOIC (ME)
(Adjustable Voltage)

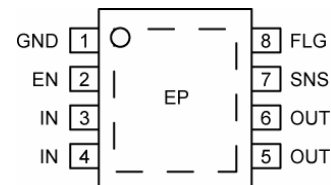

8-Pin ePad SOIC (ME)
(Fixed Voltage with Flag)

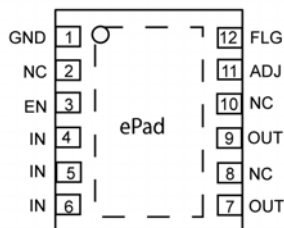

**12-Pin 4mm x 4mm MLF™ (ML)
(Adjustable Voltage with Flag)**

Pin Description

Pin Number (Fixed) SPAK-5 TO-263-5	Pin Number (Adjustable) SPAK-5 TO-263-5	Pin Number (Fixed) ePad SOIC-8	Pin Number (Adjustable) ePad SOIC-8	Pin Number (Adjustable) ePad 4mm x 4mm MLF™	Pin Name	Pin Function
1	1	2	2	3	EN	Enable (Input): CMOS compatible input. Logic high = enable, logic low = shutdown. Do not leave pin floating.
2	2	3,4	3,4	4, 5, 6	IN	Input voltage which supplies current to the output power device.
3, TAB	3, TAB	1	1	1	GND	Ground (TAB is connected to ground on S-Pak and TO-263).
4	4	5,6	5,6	7, 9	OUT	Regulator Output.
—	—	7	—	—	SNS	Output voltage sense. Connect to output voltage.
—	5	—	7	11	ADJ	Adjustable regulator feedback input. Connect to resistor voltage divider.
5	—	8	8	12	FLG	Error Flag (Output): Open collector output. Active low indicates an output fault condition.
—	—	EP	EP	EP	EP	Exposed pad. Connect to GND.
—	—	—	—	2, 8, 10	NC	No Connect. Not internally connected.

Absolute Maximum Ratings⁽¹⁾

Supply Input Voltage (V_{IN} to GND)	-0.3V to +6V
Logic Input Voltage (V_{EN} to GND)	-0.3V to ($V_{IN} + 0.3V$)
Fault Flag (V_{FLG} to GND)	-0.3V to 6V
Storage Temperature (T_S)	-65°C to +125°C
Lead Temperature (T_S)	260°C
ESD ⁽⁴⁾	2kV

Operating Ratings⁽²⁾

Supply Voltage (V_{IN})	1.65V to 5.5V
Enable Input Voltage (V_{EN})	0V to V_{IN}
Junction Temperature (T_J)	-40°C $\leq T_J \leq$ +125°C
Power Dissipation (P_D)	Internally Limited ⁽³⁾
Package Thermal Resistance	
S-PAK-5 (θ_{JC})	2°C/W
S-PAK-5 (θ_{JA})	38°C/W
TO-263-5 (θ_{JC})	2°C/W
ePad SOIC-8 (θ_{JA})	41°C/W
4x4 MLF-12L (θ_{JA})	60°C/W

Electrical Characteristics⁽⁴⁾

$T_A = 25^\circ\text{C}$ with $V_{IN} = V_{OUT} + 1V$; bold values indicate $-40^\circ\text{C} < T_J < +125^\circ\text{C}$; $I_{OUT} = 10\text{mA}$; $C_{OUT} = 10\mu\text{F}$ ceramic, unless noted.

Parameter	Test Conditions	Min	Typ	Max	Unit
Power Input Supply					
Input Voltage Range (V_{IN})		1.65		5.5	V
Ground Pin Current	$I_{OUT} = 10\text{mA}$		1.2	5	mA
	$I_{OUT} = 1.5\text{A}$		12	30	mA
	$I_{OUT} = 3.0\text{A}$		32	75	mA
Ground Pin Current in Shutdown	$V_{EN} = 0V$; $V_{IN} = 2.0V$; $V_{OUT} = 0V$		1		μA
Output Voltage					
Output Voltage (Fixed)		-2.0		2.0	%
Load Regulation	$I_{OUT} = 10\text{mA}$ to 3A		± 0.3		%
Line Regulation ⁽⁵⁾	$V_{IN} = V_{OUT} + 1.0V$ to 5.5V		0.2	0.3	%/V
Reference (Adjustable)					
Feedback Reference Voltage (ADJ Pin)	($\pm 2.0\%$)	0.490	0.5	0.510	V
Feedback Bias Current	$V_{ADJ} = 0.5V$		0.25	1.0	μA
Current Limit					
Current Limit	$V_{OUT} = 0V$	3.3	5.2		A
Power Dropout Voltage					
Dropout Voltage ($V_{IN} - V_{OUT}$) ⁽⁶⁾	$I_{OUT} = 1.5\text{A}$		200	300	mV
	$I_{OUT} = 3.0\text{A}$		275	500	mV
Enable Input					
Enable Input Threshold	Regulator Enabled	0.8	0.57		V
	Regulator Shutdown			0.2	V
Enable Pin Bias Current	$V_{EN} \leq 0.2V$ (Regulator Shutdown)		0.0		μA
	$V_{EN} \geq 0.8V$ (Regulator Enabled)		7.0		μA
Turn-on Time	90% of typical V_{OUT} ; $V_{EN} = V_{IN}$		10	150	μs
Fault Output					
Fault Threshold Voltage	% of V_{OUT} below nominal output (V_{OUT} Falling)	7.5	10	14	%
Fault Hysteresis			2.0		%
Fault Output Low Voltage	$I_{FLG} = 250\mu\text{A}$ (sinking), $V_{EN} = 0V$		150		mV

Electrical Characteristics⁽⁴⁾ (Continued)

$T_A = 25^\circ\text{C}$ with $V_{IN} = V_{OUT} + 1\text{V}$; bold values indicate $-40^\circ\text{C} < T_J < +125^\circ\text{C}$; $I_{OUT} = 10\text{mA}$; $C_{OUT} = 10\mu\text{F}$ ceramic, unless noted.

Fault Leakage Current	$V_{FLG} = 5.0\text{V}$; $V_{EN} = 0\text{V}$		0.05		μA
Thermal Protection					
Over-Temperature Shutdown	T_J Rising		165		$^\circ\text{C}$
Over-Temperature Shutdown Hysteresis			10		$^\circ\text{C}$

Notes:

- Exceeding the absolute maximum rating may damage the device.
- The device is not guaranteed to function outside its operating rating.
- The maximum allowable power dissipation of any T_A (ambient temperature) is $(P_{D(\max)} = T_{J(\max)} - T_A) / \theta_{JA}$. Exceeding the maximum allowable power dissipation will result in excessive die temperature and the regulator will go into thermal shutdown.
- Specification for packaged product only.
- Minimum input for line regulation test is set to $V_{OUT} + 1\text{V}$ relative to the highest output voltage.
- Dropout voltage is defined as the input-to-output differential at which the output voltage drops 2% below its nominal value measured at 1V differential. For outputs below 1.65V, dropout voltage is considered the input-to-output voltage differential with the minimum input voltage of 1.65V. Minimum input operating voltage is 1.65V.

Typical Characteristics

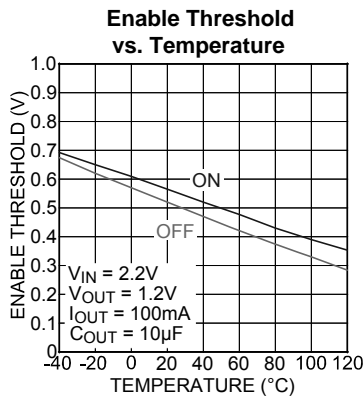
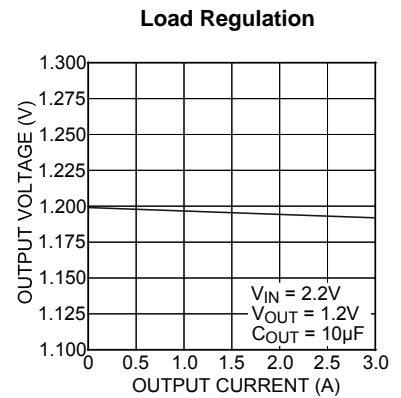
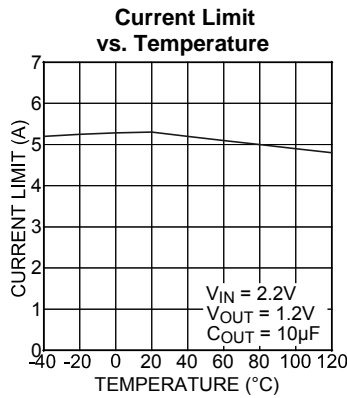
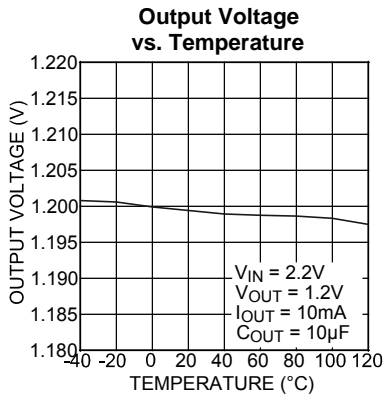
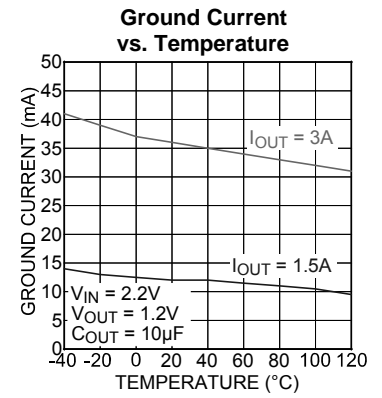
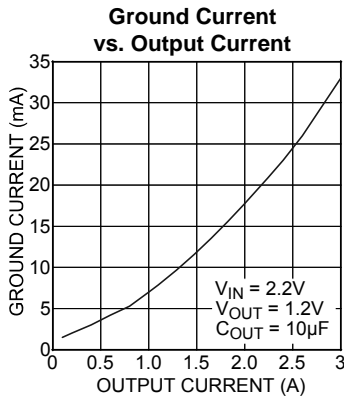
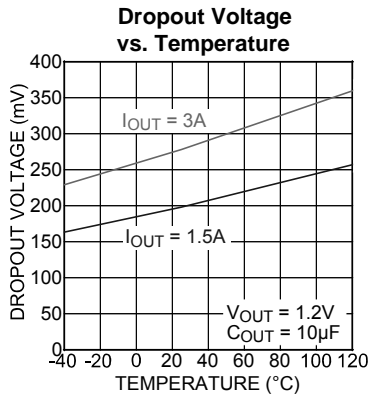
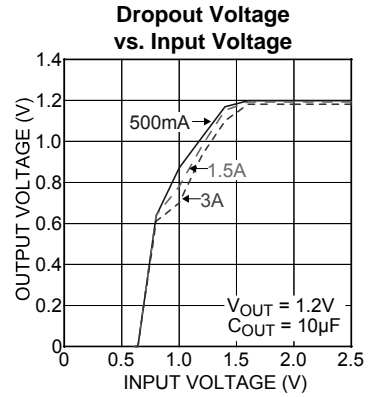
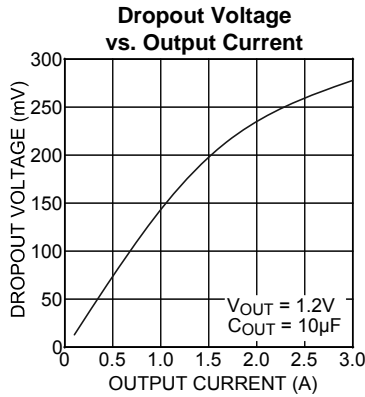
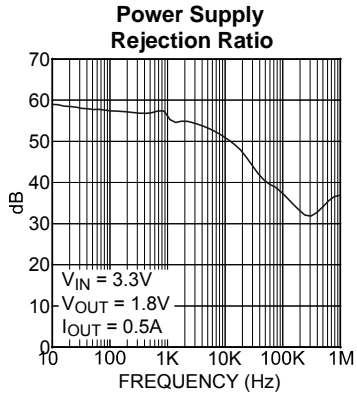

Functional Characteristics

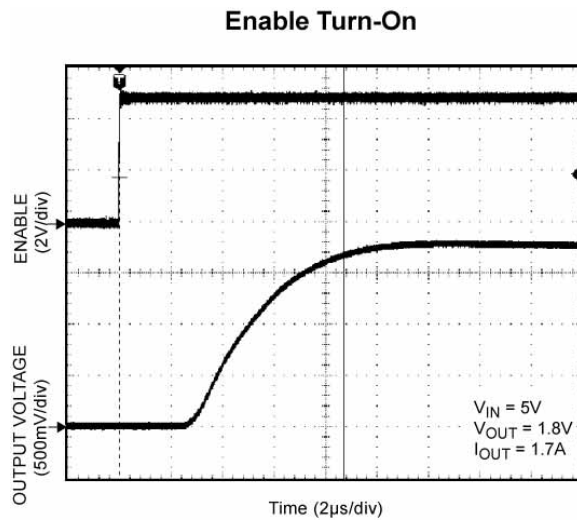
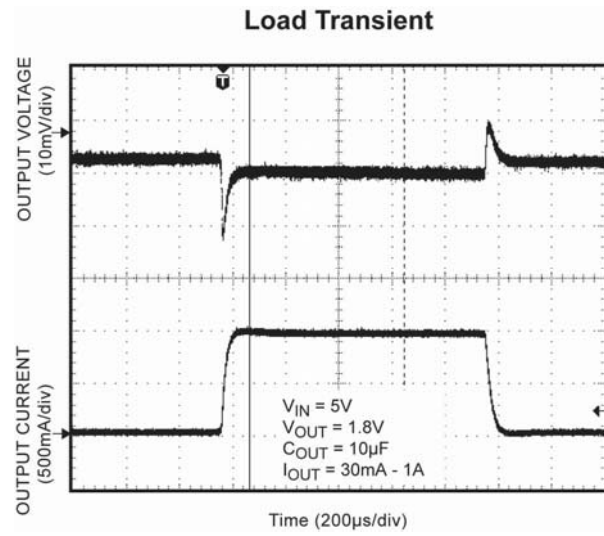
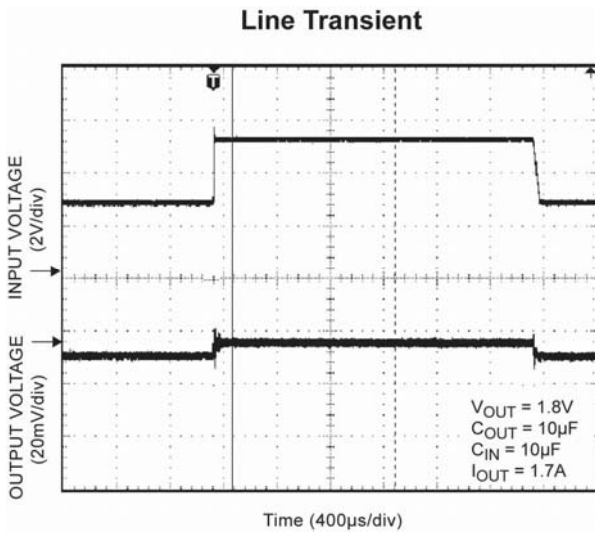

Functional Diagram

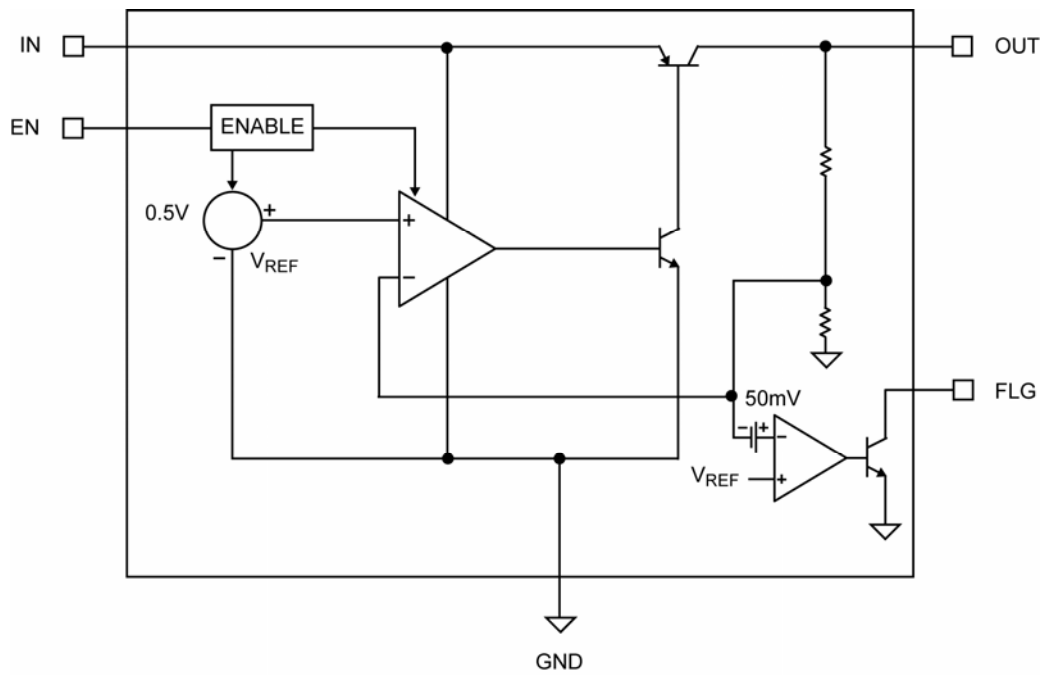

Fixed Output Regulator

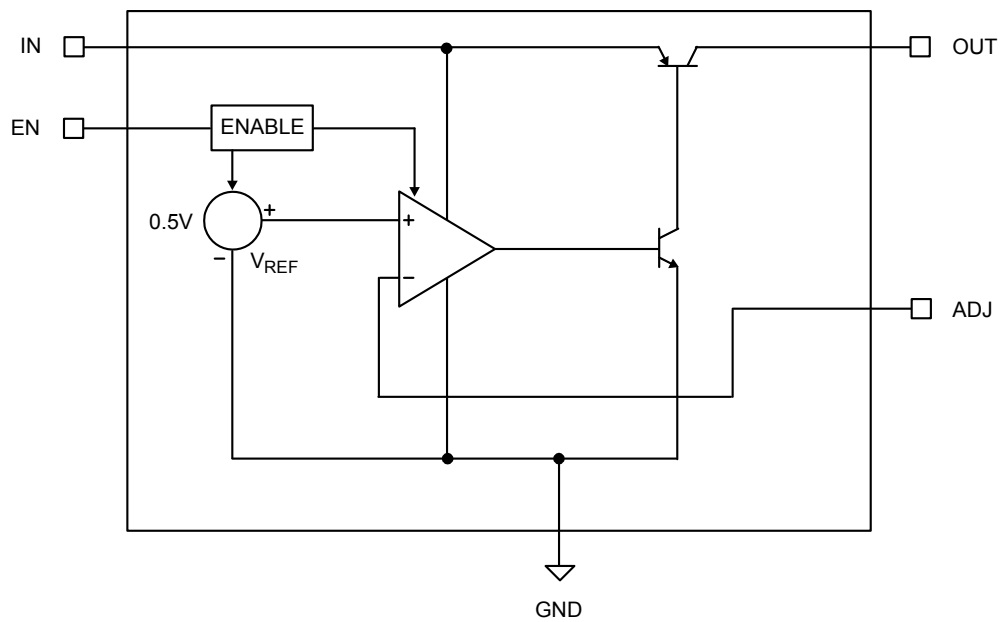

Adjustable Output Regulator

Application Information

The MIC69301/2/3 is an ultra-high performance low dropout linear regulator designed for high current applications requiring a fast transient response. It utilizes a single input supply and has a very low dropout voltage perfect for low-voltage DC-to-DC conversion. The MIC69301/2/3 requires a minimum number of external components.

The MIC69301/2/3 regulator is fully protected from damage due to fault conditions offering constant current limiting and thermal shutdown.

Input Supply Voltage

V_{IN} provides a high current to the collector of the pass transistor. The minimum input voltage is 1.65V allowing conversion from low voltage supplies.

Output Capacitor

The MIC69301/2/3 requires a minimum of output capacitance to maintain stability. However, proper capacitor selection is important to ensure desired transient response. The MIC69301/2/3 is specifically designed to be stable with low ESR ceramic chip capacitors. A 10 μ F ceramic chip capacitor should satisfy most applications. Output capacitance can be increased without bound. See typical characteristics for examples of load transient response.

X7R dielectric ceramic capacitors are recommended because of their temperature performance. X7R-type capacitors change capacitance by only 15% over their operating temperature range and are the most stable type of ceramic capacitors. Z5U and Y5V dielectric capacitors change value by as much as 50% and 60%, respectively over their operating temperature ranges. To use a ceramic chip capacitor with Y5V dielectric the value must be much higher than an X7R ceramic or a tantalum capacitor to ensure the same capacitance value over the operating temperature range. Tantalum capacitors have a very stable dielectric (10% over their operating temperature range) and can also be used with this device.

Input Capacitor

An input capacitor of 1 μ F or greater is recommended when the device is more than 4 inches away from the bulk supply capacitance or when the supply is a battery. Small, surface mount, ceramic chip capacitors can be used for the bypassing. The capacitor should be placed within 1 inch of the device for optimal performance. Larger values will help to improve ripple rejection by bypassing the input to the regulator further improving the integrity of the output voltage.

Minimum Load Current

The MIC69301/2/3 regulator is specified between finite loads. If the output current is too small, leakage currents dominate and the output voltage rises. A 10mA minimum load current is necessary for proper operation.

Adjustable Regulator Design

The MIC69302 and MIC69303 adjustable version allows programming the output voltage anywhere between 0.5V and 5.0V with two resistors. The resistor value between V_{OUT} and the adjust pin should not exceed 10k Ω . Larger values can cause instability. The resistor values are calculated by:

$$V_{OUT} = 0.5 \times \left(\frac{R_1}{R_2} + 1 \right)$$

where V_{OUT} is the desired output voltage.

Enable

The fixed output voltage versions of the MIC69301 feature an active high enable input (EN) that allows on-off control of the regulator. Current drain reduces to near "zero" when the device is shutdown, with only microamperes of leakage current. EN may be directly tied to V_{IN} and pulled up to the maximum supply voltage.

Thermal Design

Linear regulators are simple to use. The most complicated design parameters to consider are thermal characteristics. Thermal design requires the following application-specific parameters:

- Maximum ambient temperature (T_A)
- Output current (I_{OUT})
- Output voltage (V_{OUT})
- Input voltage (V_{IN})
- Ground current (I_{GND})

First, calculate the power dissipation of the regulator from these numbers and the device parameters from this data sheet.

$$P_D = (V_{IN} - V_{OUT}) \times I_{OUT} + V_{IN} \times I_{GND}$$

where the ground current is approximated by using numbers from the "Electrical Characteristics" or "Typical Characteristics" sections. The heat sink thermal resistance is then determined with this formula:

$$\theta_{SA} = ((T_J(\max) - T_A) / P_D) - (\theta_{JC} + \theta_{CS})$$

Where $T_J(\max) \leq 125^\circ\text{C}$ and θ_{CS} is between 0°C and 2°C/W .

The heat sink may be significantly reduced in applications where the minimum input voltage is known and is large compared with the dropout voltage. Use a series input resistor to drop excessive voltage and distribute the heat between this resistor and the regulator. The low dropout properties of Micrel Super β PNP[®] regulators allow significant reductions in regulator power dissipation and the associated heat sink

without compromising performance. When this technique is employed, a capacitor of at least 1.0 μ F is needed directly between the input and regulator ground.

Refer to "Application Note 9" for further details and examples on thermal design and heat sink applications.

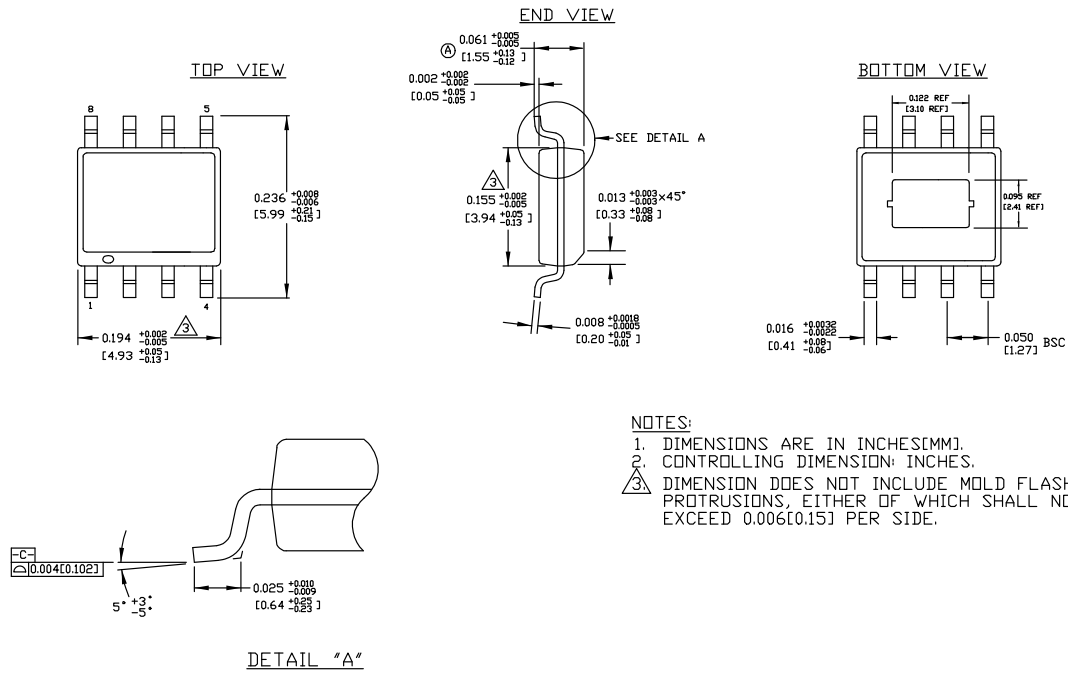

NOTES:

1. DIMENSIONS ARE IN INCHES[MM].
2. CONTROLLING DIMENSION: INCHES.
3. DIMENSION DOES NOT INCLUDE MOLD FLASH OR PROTRUSIONS, EITHER OF WHICH SHALL NOT EXCEED 0.006[0.15] PER SIDE.

8-Pin ePad SOIC (ME)

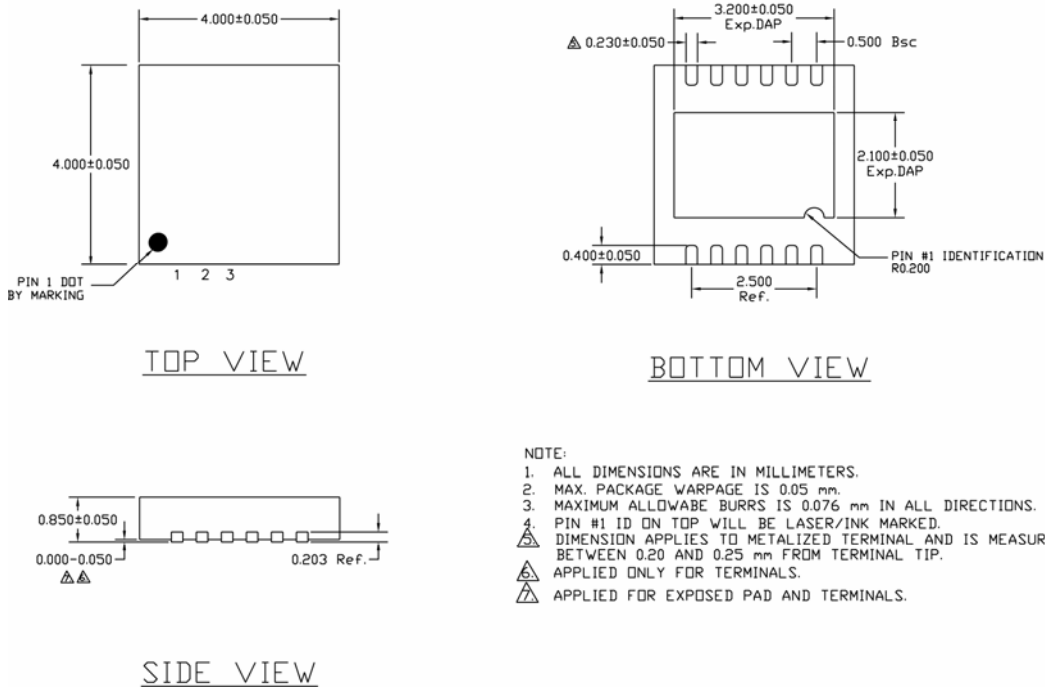

NOTE:

1. ALL DIMENSIONS ARE IN MILLIMETERS.
2. MAX. PACKAGE WARPAGE IS 0.05 mm.
3. MAXIMUM ALLOWABLE BURRS IS 0.076 mm IN ALL DIRECTIONS.
4. PIN #1 ID ON TOP WILL BE LASER/INK MARKED.

3. DIMENSION APPLIES TO METALIZED TERMINAL AND IS MEASURED BETWEEN 0.20 AND 0.25 mm FROM TERMINAL TIP.

4. APPLIED ONLY FOR TERMINALS.

5. APPLIED FOR EXPOSED PAD AND TERMINALS.

12-Pin ePad MLF 4x4 (ML)

MICREL, INC. 2180 FORTUNE DRIVE SAN JOSE, CA 95131 USA
TEL +1 (408) 944-0800 FAX +1 (408) 474-1000 WEB <http://www.micrel.com>

Micrel makes no representations or warranties with respect to the accuracy or completeness of the information furnished in this data sheet. This information is not intended as a warranty and Micrel does not assume responsibility for its use. Micrel reserves the right to change circuitry, specifications and descriptions at any time without notice. No license, whether express, implied, arising by estoppel or otherwise, to any intellectual property rights is granted by this document. Except as provided in Micrel's terms and conditions of sale for such products, Micrel assumes no liability whatsoever, and Micrel disclaims any express or implied warranty relating to the sale and/or use of Micrel products including liability or warranties relating to fitness for a particular purpose, merchantability, or infringement of any patent, copyright or other intellectual property right.

Micrel Products are not designed or authorized for use as components in life support appliances, devices or systems where malfunction of a product can reasonably be expected to result in personal injury. Life support devices or systems are devices or systems that (a) are intended for surgical implant into the body or (b) support or sustain life, and whose failure to perform can be reasonably expected to result in a significant injury to the user. A Purchaser's use or sale of Micrel Products for use in life support appliances, devices or systems is a Purchaser's own risk and Purchaser agrees to fully indemnify Micrel for any damages resulting from such use or sale.

© 2010 Micrel, Incorporated.



Компания «ЭлектроПласт» предлагает заключение долгосрочных отношений при поставках импортных электронных компонентов на взаимовыгодных условиях!

Наши преимущества:

- Оперативные поставки широкого спектра электронных компонентов отечественного и импортного производства напрямую от производителей и с крупнейших мировых складов;
- Поставка более 17-ти миллионов наименований электронных компонентов;
- Поставка сложных, дефицитных, либо снятых с производства позиций;
- Оперативные сроки поставки под заказ (от 5 рабочих дней);
- Экспресс доставка в любую точку России;
- Техническая поддержка проекта, помощь в подборе аналогов, поставка прототипов;
- Система менеджмента качества сертифицирована по Международному стандарту ISO 9001;
- Лицензия ФСБ на осуществление работ с использованием сведений, составляющих государственную тайну;
- Поставка специализированных компонентов (Xilinx, Altera, Analog Devices, Intersil, Interpoint, Microsemi, Aeroflex, Peregrine, Syfer, Eurofarad, Texas Instrument, Miteq, Cobham, E2V, MA-COM, Hittite, Mini-Circuits, General Dynamics и др.);

Помимо этого, одним из направлений компании «ЭлектроПласт» является направление «Источники питания». Мы предлагаем Вам помощь Конструкторского отдела:

- Подбор оптимального решения, техническое обоснование при выборе компонента;
- Подбор аналогов;
- Консультации по применению компонента;
- Поставка образцов и прототипов;
- Техническая поддержка проекта;
- Защита от снятия компонента с производства.

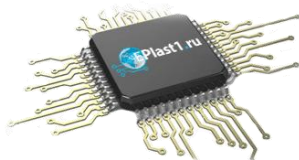

Как с нами связаться

Телефон: 8 (812) 309 58 32 (многоканальный)

Факс: 8 (812) 320-02-42

Электронная почта: org@eplast1.ru

Адрес: 198099, г. Санкт-Петербург, ул. Калинина, дом 2, корпус 4, литера А.