

5GHz Band SPDT Switch + LNA GaAs MMIC

■ GENERAL DESCRIPTION

The NJG1739K51 is a 5GHz band SPDT switch + low noise amplifier GaAs MMIC designed for wireless LAN front-end applications.

The NJG1739K51 features low current consumption, low insertion loss of transmit path and low noise figure of RX LNA mode.

The NJG1739K51 has ESD protection devices to achieve excellent ESD performances.

A small and ultra-thin package of QFN12-51 is adopted.

■ PACKAGE OUTLINE

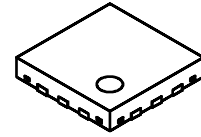

NJG1739K51

■ APPLICATIONS

5GHz Band WLAN front-end application

■ FEATURES

- Operating voltage $V_{DD}=3.6V$ typ.
- Operating frequency freq=4900 to 5900MHz

[RX LNA mode]

- Operating current 8mA typ. @ $V_{DD}=3.6V$, $V_{CTL1}=V_{CTL3}=3.3V$, $V_{CTL2}=0V$
- Small signal gain 12.0dB typ.
- Noise figure 2.5dB typ.
- Input power 1dB compression 0dBm typ.

[RX Bypass mode]

- Operating current 4 μ A typ. @ $V_{DD}=3.6V$, $V_{CTL1}=3.3V$, $V_{CTL2}=V_{CTL3}=0V$
- Insertion loss 8.5dB typ.
- Input power 1dB compression +15dBm typ.

[TX mode]

- Insertion loss 0.5dB typ.
- Input power 0.1dB compression +29dBm typ.

- Package QFN12-51 (Package size: 2.0mm x 2.0mm x 0.375mm typ.)
- RoHS compliant and Halogen Free, MSL1

■ PIN CONFIGURATION

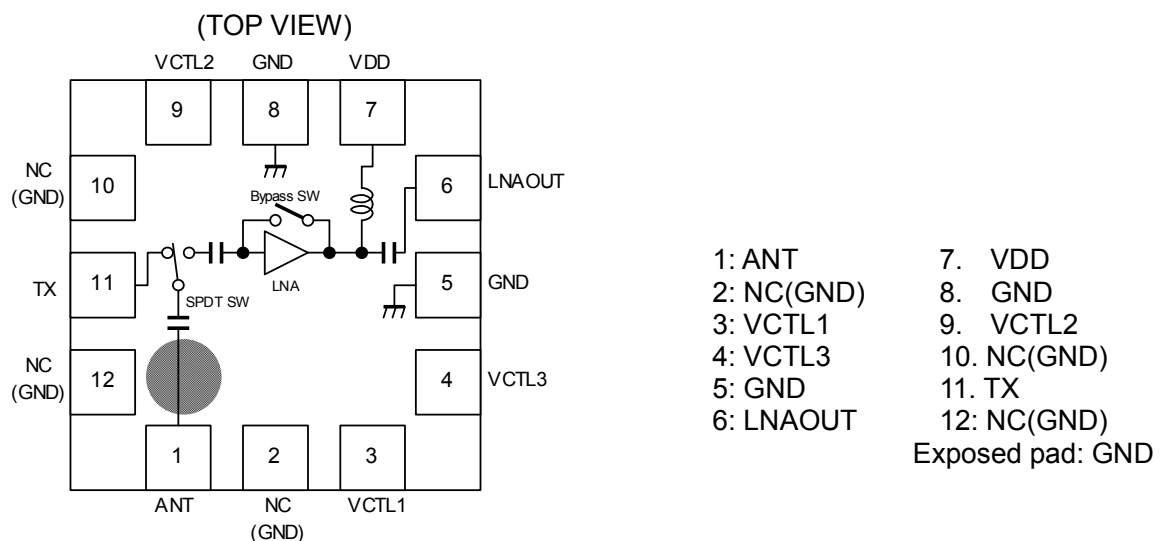

Note: Specifications and description listed in this datasheet are subject to change without notice.

■ TRUTH TABLE

“H”=V_{CTL}(H), “L”=V_{CTL}(L)

mode	VCTL1 (SW RX)	VCTL2 (SW TX)	VCTL3 (LNA)	STATE				
				IDD	LNA	Bypass	RX SW	TX SW
RX LNA	H	L	H	I _{DD1}	ON	OFF	ON	OFF
RX Bypass	H	L	L	I _{DD2}	OFF	ON	ON	OFF
TX	L	H	L	I _{DD2}	OFF	ON	OFF	ON
Sleep	L	L	L	I _{DD3}	OFF	OFF	OFF	OFF

■ ABSOLUTE MAXIMUM RATINGS

$T_a=+25^{\circ}\text{C}$

PARAMETERS	SYMBOL	CONDITIONS	RATINGS	UNITS
Supply voltage	V_{DD}		5.5	V
Control voltage	V_{CTL}		5.5	V
Input power 1	P_{IN1}	ANT terminal, $V_{DD}=3.6\text{V}$, $V_{CTL1}=V_{CTL3}=3.3\text{V}$, $V_{CTL2}=0\text{V}$	+15	dBm
Input power 2	P_{IN2}	TX terminal, $V_{DD}=3.6\text{V}$, $V_{CTL1}=V_{CTL3}=0\text{V}$, $V_{CTL2}=3.3\text{V}$	+25	dBm
Power dissipation	P_D	Four-layer FR4 PCB with through-hole (101.5x114.5mm), $T_j=150^{\circ}\text{C}$	1190	mW
Operation temperature	T_{opr}		-40 to +85	$^{\circ}\text{C}$
Storage temperature	T_{stg}		-55 to +150	$^{\circ}\text{C}$

■ ELECTRICAL CHARACTERISTICS 1 (DC Characteristics)

$V_{DD}=3.6\text{V}$, $V_{CTL(H)}=3.3\text{V}$, $V_{CTL(L)}=0\text{V}$, $T_a=+25^{\circ}\text{C}$, $Z_s=Z_l=50\Omega$

PARAMETERS	SYMBOL	CONDITIONS	MIN	TYP	MAX	UNITS
Supply voltage	V_{DD}		3.0	3.6	5.0	V
Control voltage 1(High)	$V_{CTL1(H)}$		2.8	3.3	5.0	V
Control voltage 2(High)	$V_{CTL2(H)}$		2.8	3.3	5.0	V
Control voltage 3(High)	$V_{CTL3(H)}$		2.8	3.3	5.0	V
Control voltage 1(Low)	$V_{CTL1(L)}$		0.0	-	0.4	V
Control voltage 2(Low)	$V_{CTL2(L)}$		0.0	-	0.4	V
Control voltage 3(Low)	$V_{CTL3(L)}$		0.0	-	0.4	V
LNA operating current 1 (RX LNA mode)	I_{DD1}	RF OFF, $V_{CTL1}=V_{CTL3}=3.3\text{V}$, $V_{CTL2}=0\text{V}$	-	8	13	mA
LNA operating current 2 (RX Bypass mode)	I_{DD2}	RF OFF, $V_{CTL1}=3.3\text{V}$, $V_{CTL2}=V_{CTL3}=0\text{V}$	-	4	12	μA
LNA operating current 3 (Sleep mode)	I_{DD3}	RF OFF, $V_{CTL1}=V_{CTL2}=V_{CTL3}=0.4\text{V}$	-	4	12	μA
LNA operating current 4 (VCTL OPEN)	I_{DD4}	RF OFF, $V_{CTL1}=V_{CTL2}=V_{CTL3}=\text{open}$	-	4	12	μA
Control current 1	I_{CTL1}	RF OFF, $V_{CTL1}=3.3\text{V}$, $V_{CTL2}=V_{CTL3}=0\text{V}$	-	5	20	μA
Control current 2	I_{CTL2}	RF OFF, $V_{CTL2}=3.3\text{V}$, $V_{CTL1}=V_{CTL3}=0\text{V}$	-	5	20	μA
Control current 3	I_{CTL3}	RF OFF, $V_{CTL3}=3.3\text{V}$, $V_{CTL1}=V_{CTL2}=0\text{V}$	-	5	20	μA

■ ELECTRICAL CHARACTERISTICS 2 (RF Characteristics: RX LNA mode, LNA+SPDT SW)

$V_{DD}=3.6V$, $V_{CTL1}=V_{CTL3}=3.3V$, $V_{CTL2}=0V$, $freq=4900$ to $5900MHz$,
 $T_a=+25^{\circ}C$, $Z_s=Z_l=50\Omega$, with application circuit

PARAMETERS	SYMBOL	CONDITIONS	MIN	TYP	MAX	UNITS
Small signal gain 1	Gain1	Exclude PCB and connector losses*1	9.0	12.0	14.0	dB
Gain flatness 1	Gflat1	f=4900 to 4980MHz, f=5400 to 5480MHz, f=5820 to 5900MHz	-	-	0.3	dB
Isolation 1	ISL1		-	30	-	dB
Noise figure 1	NF1	Exclude PCB and connector losses*2	-	2.5	3.0	dB
Input power at 1dB compression 1	$P_{-1dB(IN)1}$		-	0	-	dBm
Input 3rd order Intercept point 1	IIP3_1	f1=freq, f2=freq+100kHz, $P_{IN}=-18dBm$	-	+9	-	dBm
Outband input 3rd order Intercept point 1	IIP3_OB1	f1=2450MHz, f2=f1+100kHz, $P_{IN}=-18dBm$	-	+2	-	dBm
ANT port return loss 1	RLi1		-	8.0	-	dB
LNAOUT port return loss 1	RLo1		-	9.0	-	dB
LNA switching time	Tsw1_1	10% V_{CTL} to 90% RF	-	250	400	ns
Other switching time	Tsw2_1	10% V_{CTL} to 90% RF	-	200	500	ns

*1) 0.64dB(4900MHz), 0.71dB(5400MHz), 0.79dB(5900MHz)

*2) 0.32dB(4900MHz), 0.35dB(5400MHz), 0.39dB(5900MHz)

■ ELECTRICAL CHARACTERISTICS 3 (RF Characteristics: RX Bypass mode, Bypass SW+SPDT SW)

$V_{DD}=3.6V$, $V_{CTL1}=3.3V$, $V_{CTL2}=V_{CTL3}=0V$, $freq=4900$ to $5900MHz$,
 $T_a=+25^{\circ}C$, $Z_s=Z_l=50\Omega$, with application circuit

PARAMETERS	SYMBOL	CONDITIONS	MIN	TYP	MAX	UNITS
Insertion loss 2	LOSS2	Exclude PCB and connector losses*3	6.0	8.5	10.5	dB
Input power at 1dB compression 2	$P_{-1dB(IN)2}$		-	+15	-	dBm
Input 3rd order Intercept point 2	IIP3_2	f1=freq, f2=freq+100kHz, $P_{IN}=-10dBm$	-	+14	-	dBm
ANT port return loss 2	RLi2		-	7.0	-	dB
LNAOUT port return loss 2	RLo2		-	12.0	-	dB

*3) 0.64dB(4900MHz), 0.71dB(5400MHz), 0.79dB(5900MHz)

■ ELECTRICAL CHARACTERISTICS 4 (RF Characteristics: TX mode, SPDT SW)

$V_{DD}=3.6V$, $V_{CTL1}=V_{CTL3}=0V$, $V_{CTL2}=3.3V$, freq=4900 to 5900MHz,
 $T_a=+25^{\circ}C$, $Z_s=Z_l=50\Omega$, with application circuit

PARAMETERS	SYMBOL	CONDITIONS	MIN	TYP	MAX	UNITS
Insertion loss 3	LOSS3	$P_{IN}=+23dBm$, Exclude PCB and connector losses*4	-	0.5	0.8	dB
Input power at 0.1dB compression 3	$P_{-0.1dB(IN)3}$		-	+29	-	dBm
ANT port return loss 3	RLi3		-	16	-	dB
TX port return loss 3	RLo3		-	20	-	dB

*4) 0.65dB(4900MHz), 0.73dB(5400MHz), 0.81dB(5900MHz)

■ TERMINAL INFORMATION

Pin No.	SYMBOL	DESCRIPTION
1	ANT	RF transmitting/receiving terminal. No DC blocking capacitor is required for this port because of internal capacitor.
2	NC(GND)	No connected terminal. This terminal is not connected with internal circuit. Please connect to the PCB ground plane.
3	VCTL1	Control signal input terminal. This terminal is set to High-Level (+2.8 to +5.0V) or Low-Level (0 to +0.4V).
4	VCTL3	Control signal input terminal. This terminal is set to High-Level (+2.8 to +5.0V) or Low-Level (0 to +0.4V).
5	GND	Ground terminal. Please connect this terminal with ground plane as close as possible for excellent RF performance.
6	LNAOUT	RF receiving signal output terminal. No DC blocking capacitor is required for this port because of internal output matching circuit including DC blocking capacitor.
7	VDD	Positive voltage supply terminal. The positive voltage (+3.0 to +5.0V) has to be supplied. Please connect a bypass capacitor with GND terminal for excellent RF performance.
8	GND	Ground terminal. Please connect this terminal with ground plane as close as possible for excellent RF performance.
9	VCTL2	Control signal input terminal. This terminal is set to High-Level (+2.8 to +5.0V) or Low-Level (0 to +0.4V).
10	NC(GND)	No connected terminal. This terminal is not connected with internal circuit. Please connect to the PCB ground plane.
11	TX	RF transmitting signal input terminal. DC blocking capacitor is required for this port.
12	NC(GND)	No connected terminal. This terminal is not connected with internal circuit. Please connect to the PCB ground plane.
Exposed Pad	GND	Ground terminal. Please connect this terminal with ground plane as close as possible for excellent RF performance, and through holes for GND should be placed near by the pin connection

■ ELECTRICAL CHARACTERISTICS (RX LNA mode)

$V_{DD}=3.6V$, $V_{CTL1}=V_{CTL3}=3.3V$, $V_{CTL2}=0V$, $T_a=+25^{\circ}C$, $Z_s=Z_l=50\Omega$

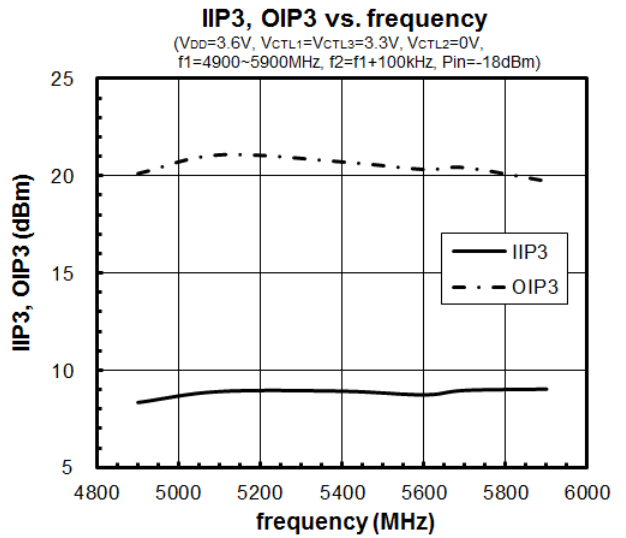
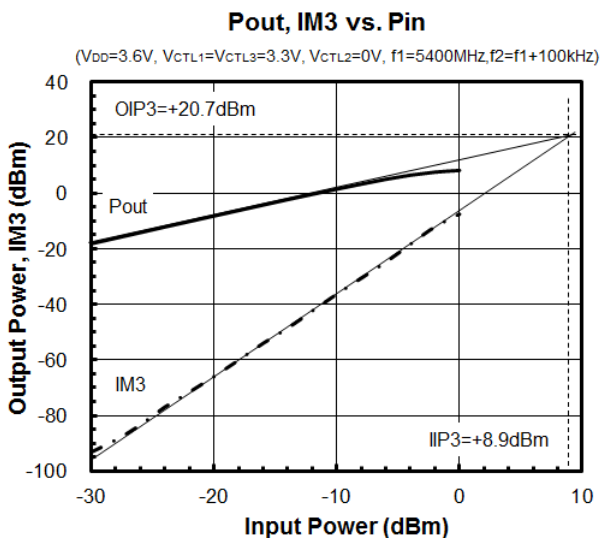
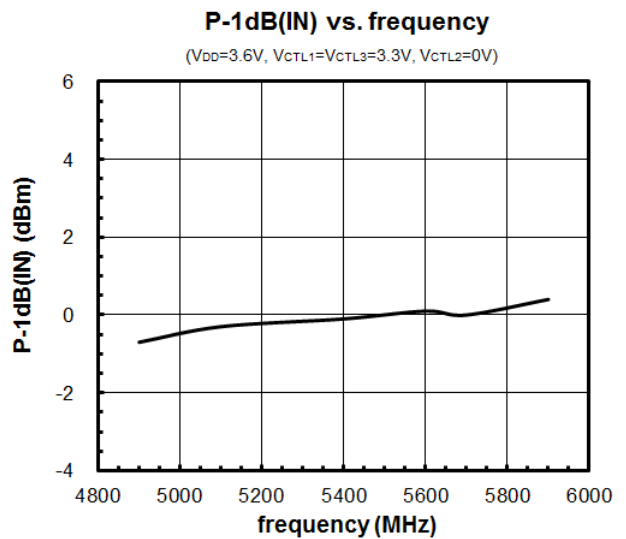
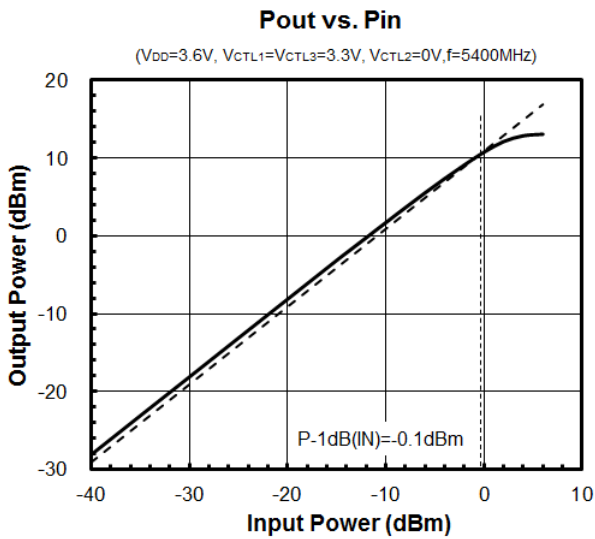
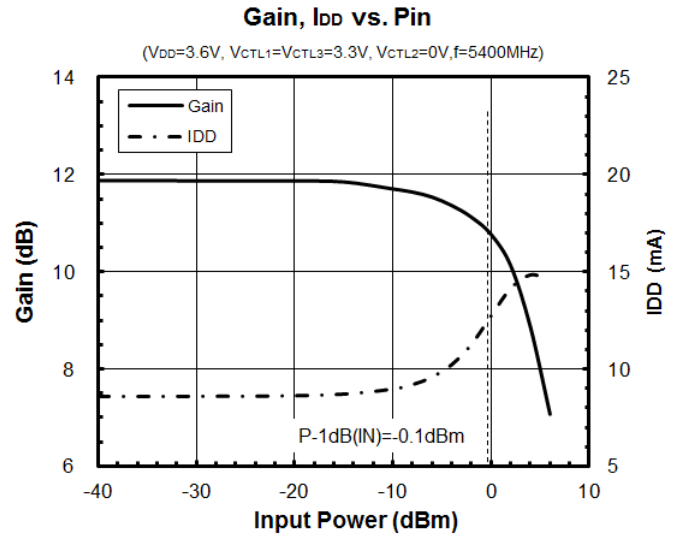
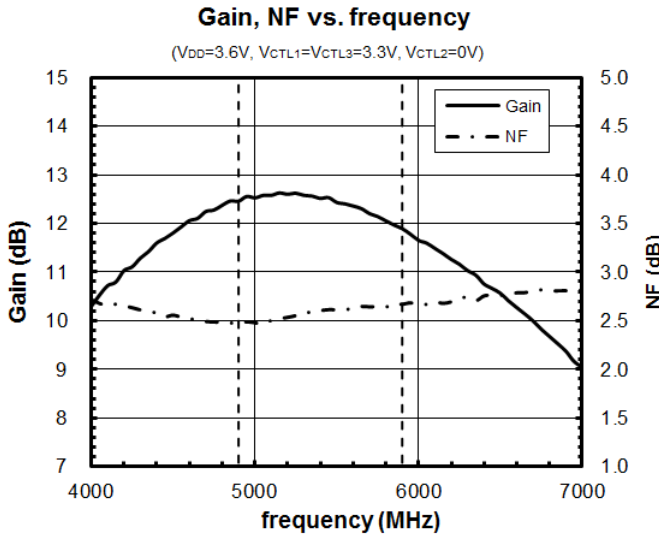

ELECTRICAL CHARACTERISTICS (RX LNA mode)

$V_{DD}=3.6V$, $V_{CTL1}=V_{CTL3}=3.3V$, $V_{CTL2}=0V$, $T_a=+25^{\circ}C$, $Z_s=Z_l=50\Omega$

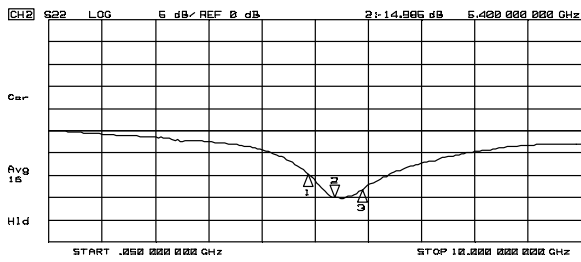
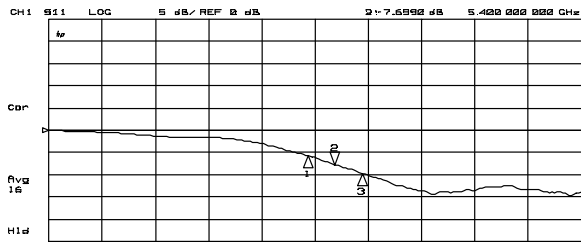

S11, S22 (f=50MHz to 10GHz)

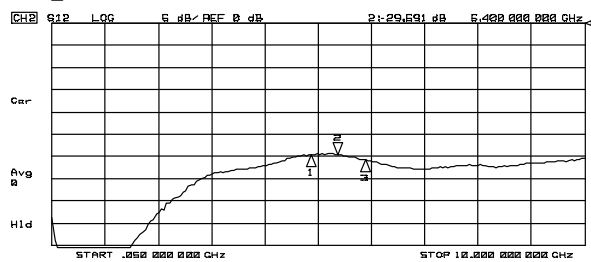
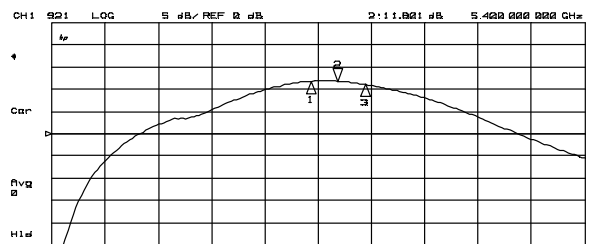

S21, S12 (f=50MHz to 10GHz)

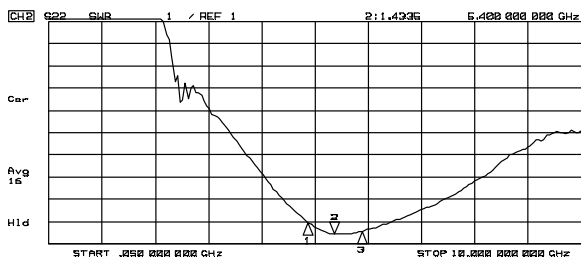
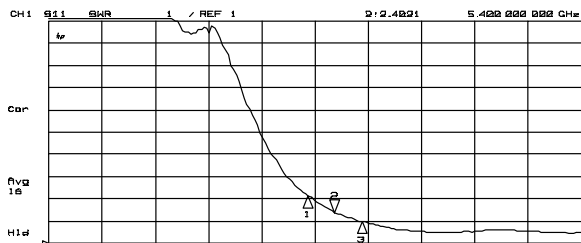

VSWRi, VSWRo (f=50MHz to 10GHz)

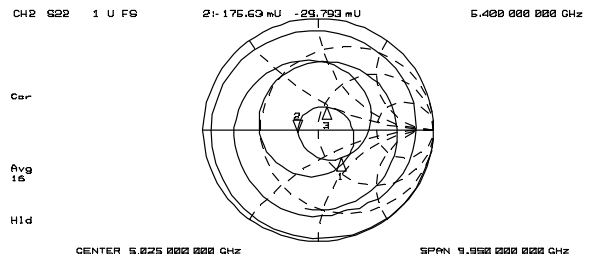
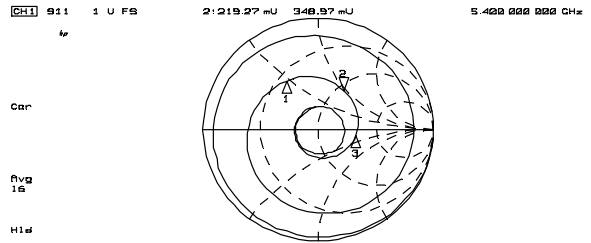

Zin, Zout (f=50MHz to 10GHz)

ELECTRICAL CHARACTERISTICS (RX LNA mode)

$V_{DD}=3.6V$, $V_{CTL1}=V_{CTL3}=3.3V$, $V_{CTL2}=0V$, $T_a=+25^\circ C$, $Z_s=Z_l=50\Omega$

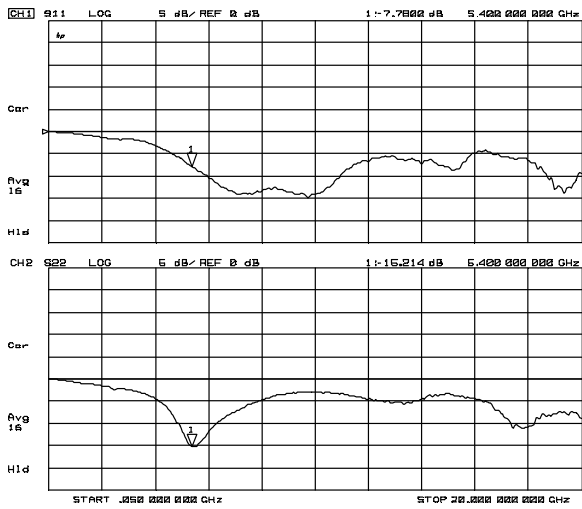

S11, S22 (f=50MHz to 20GHz)

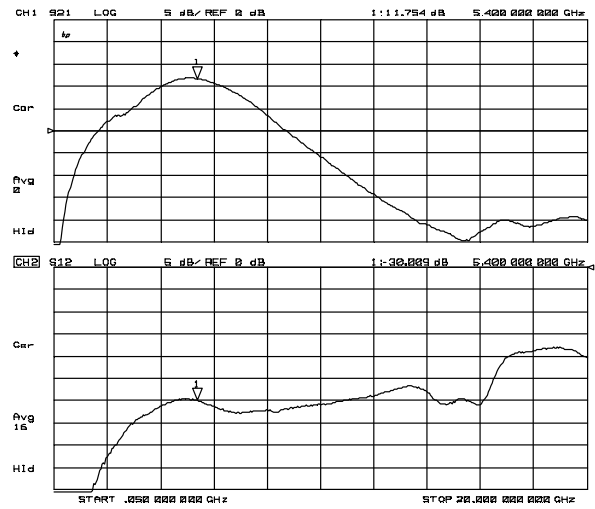

S21, S12 (f=50MHz to 20GHz)

ELECTRICAL CHARACTERISTICS (RX LNA mode)

$V_{CTL1}=V_{CTL3}=3.3V$, $V_{CTL2}=0V$, $Z_s=Z_l=50\Omega$

k factor vs. frequency

($V_{DD}=3.6V$, $V_{CTL1}=V_{CTL3}=3.3V$, $V_{CTL2}=0V$)

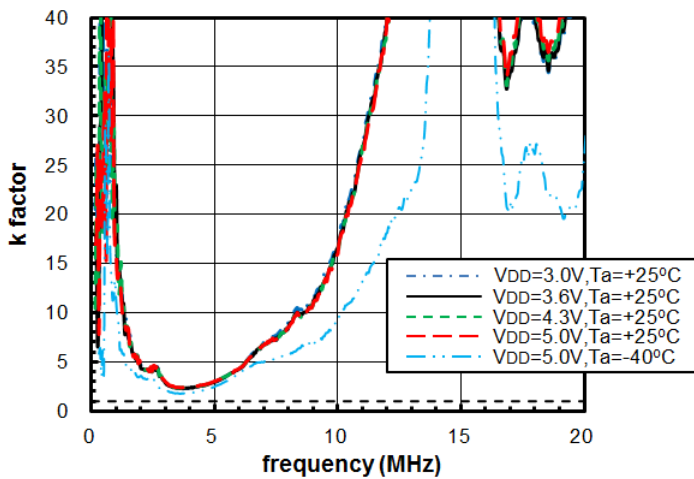

■ ELECTRICAL CHARACTERISTICS (RX LNA mode)

$V_{CTL1}=V_{CTL3}=3.3V, V_{CTL2}=0V, Z_s=Z_i=50\Omega$

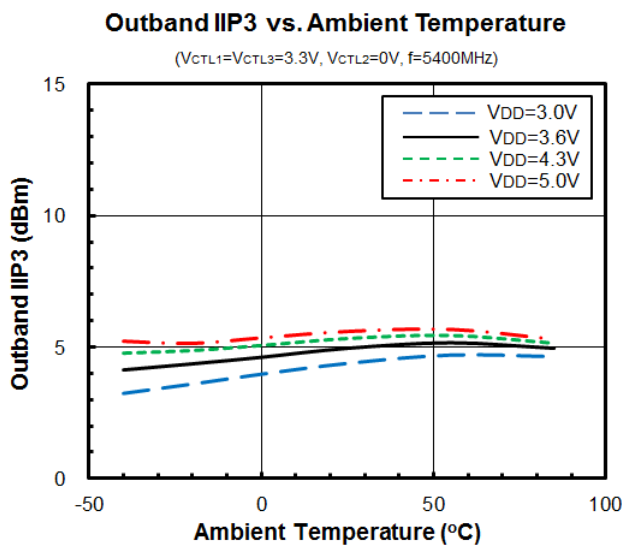
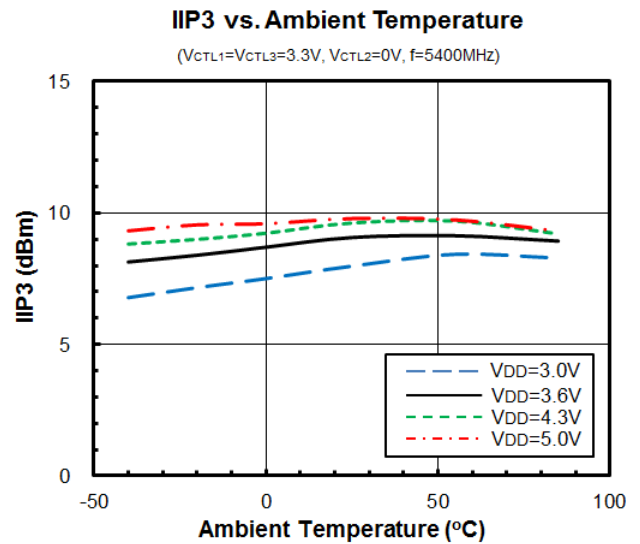
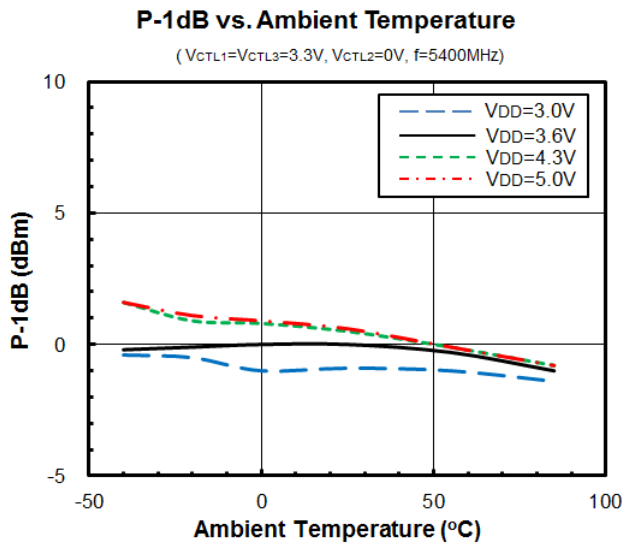
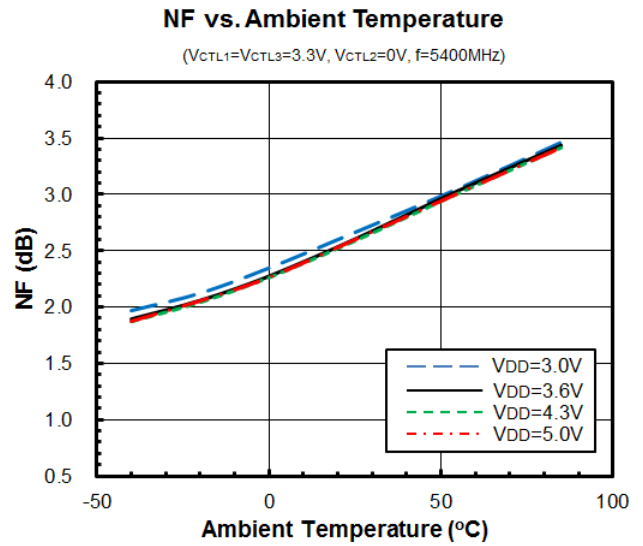
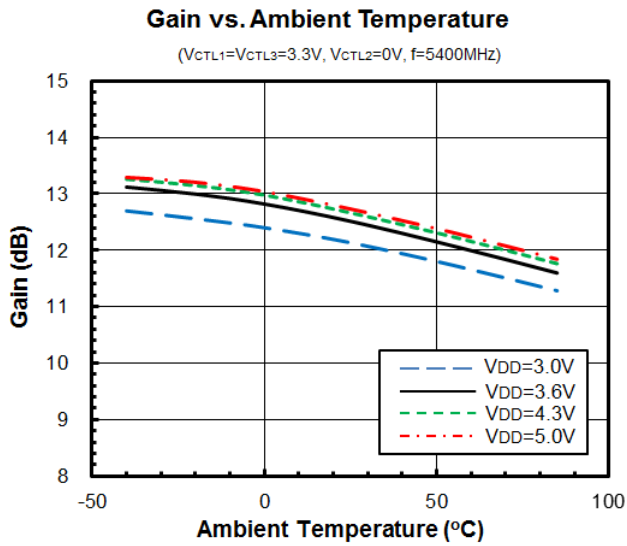

■ ELECTRICAL CHARACTERISTICS (RX LNA mode)

$V_{CTL1}=V_{CTL3}=3.3V$, $V_{CTL2}=0V$, $Z_s=Z_l=50\Omega$

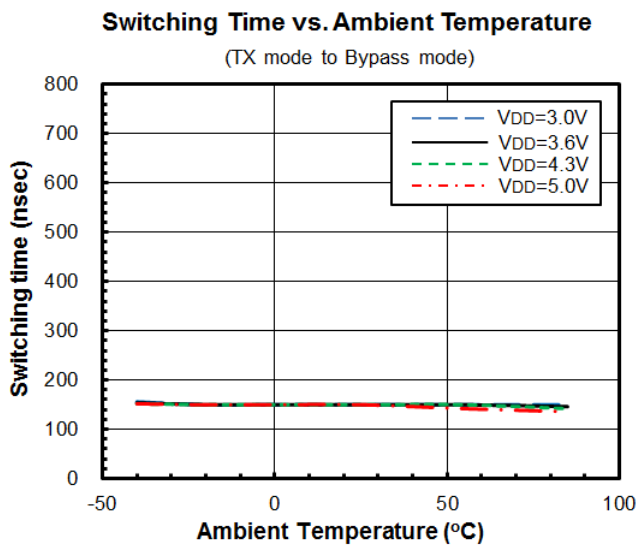
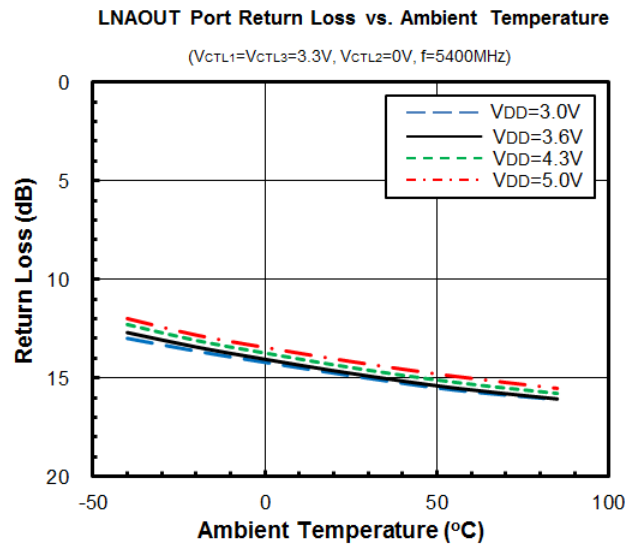
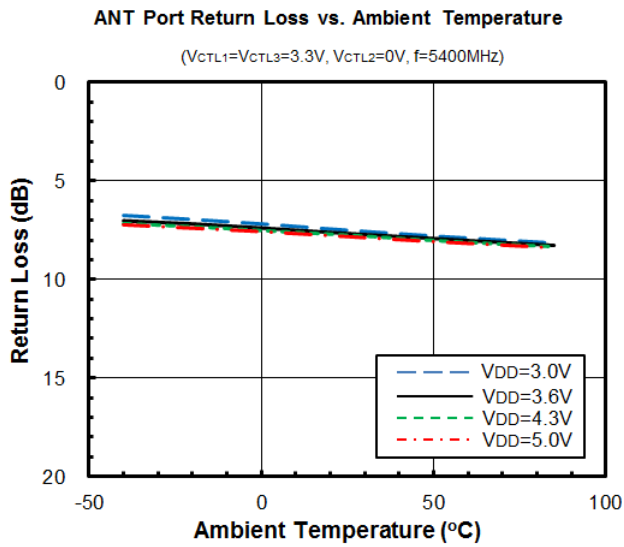

■ ELECTRICAL CHARACTERISTICS (RX Bypass mode)

$V_{DD}=3.6V$, $V_{CTL1}=3.3V$, $V_{CTL2}=V_{CTL3}=0V$, $T_a=+25^{\circ}C$, $Z_s=Z_l=50\Omega$

Bypass mode Loss vs. frequency

($V_{DD}=3.6V$, $V_{CTL1}=3.3V$, $V_{CTL2}=V_{CTL3}=0V$)

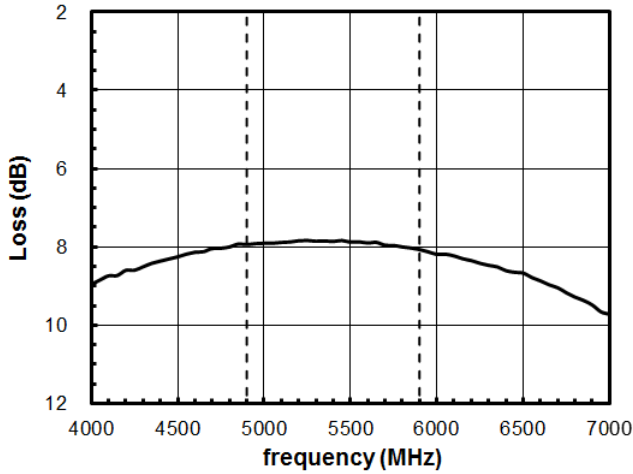

Loss vs. Pin

($V_{DD}=3.6V$, $V_{CTL1}=3.3V$, $V_{CTL2}=V_{CTL3}=0V$, $f=5400MHz$)

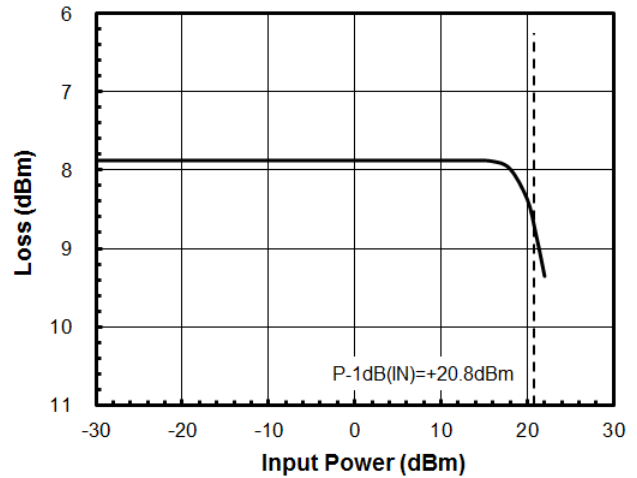

Pout vs. Pin

($V_{DD}=3.6V$, $V_{CTL1}=3.3V$, $V_{CTL2}=V_{CTL3}=0V$, $f=5400MHz$)

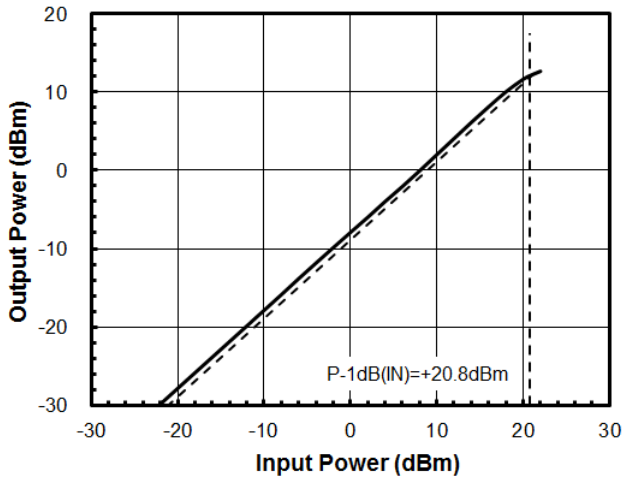

P-1dB(IN) vs. frequency

($V_{DD}=3.6V$, $V_{CTL1}=3.3V$, $V_{CTL2}=V_{CTL3}=0V$)

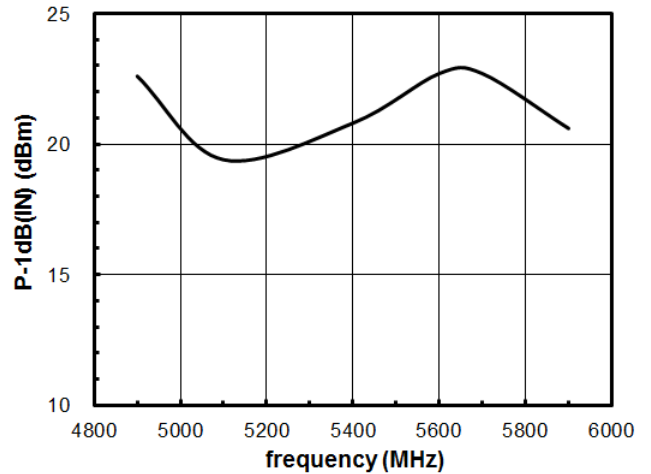

Pout, IM3 vs. Pin

($V_{DD}=3.6V$, $V_{CTL1}=3.3V$, $V_{CTL2}=V_{CTL3}=0V$, $f_1=5400MHz$, $f_2=f_1+100kHz$)

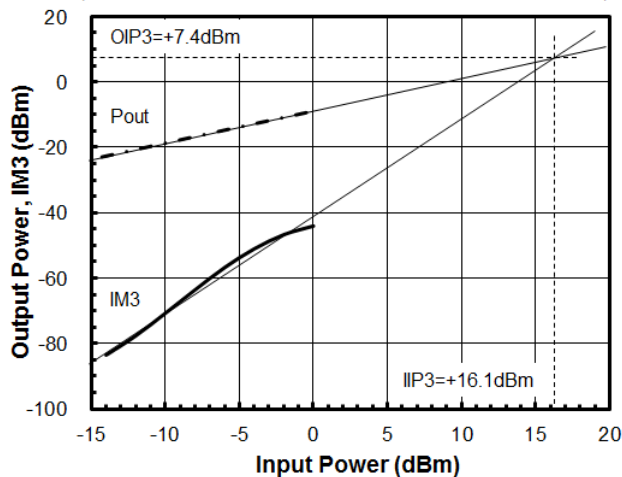

IIP3, OIP3 vs. frequency

($V_{DD}=3.6V$, $V_{CTL1}=3.3V$, $V_{CTL2}=V_{CTL3}=0V$, $f_1=4900\sim 5900MHz$, $f_2=f_1+100kHz$, $Pin=-10dBm$)

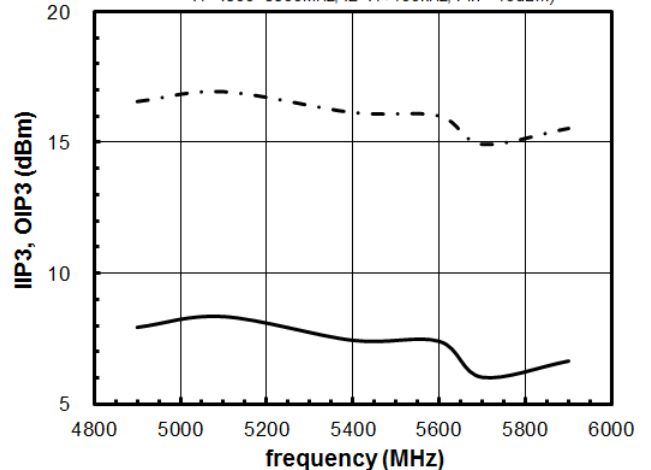

ELECTRICAL CHARACTERISTICS (RX Bypass mode)

$V_{DD}=3.6V, V_{CTL1}=3.3V, V_{CTL2}=V_{CTL3}=0V, T_a=+25^{\circ}C, Z_s=Z_l=50\Omega$

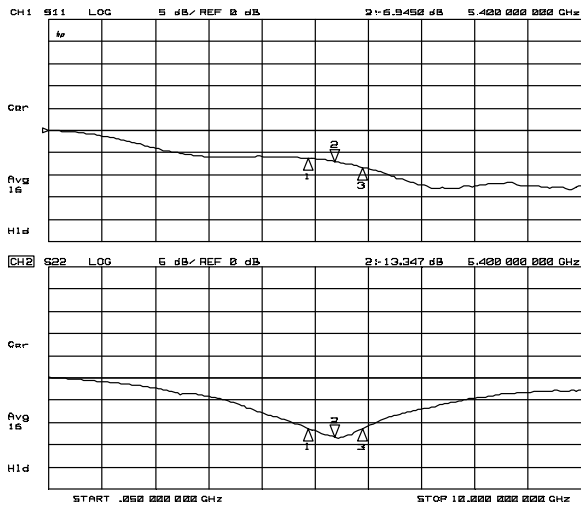

S11, S22 (f=50MHz to 10GHz)

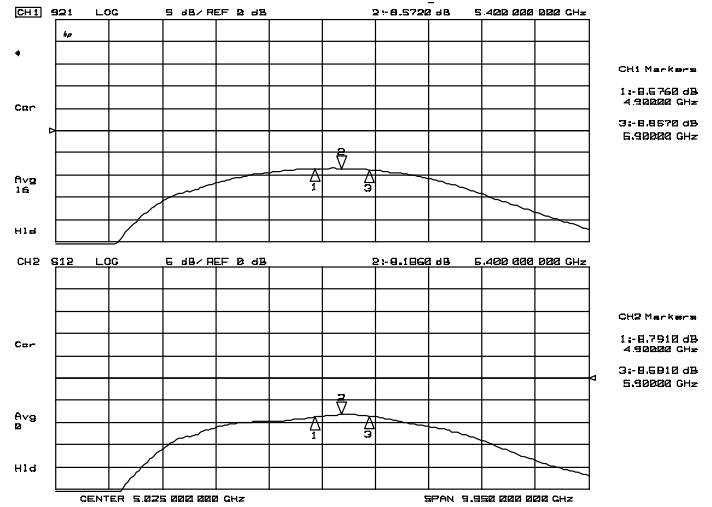

S21, S12 (f=50MHz to 10GHz)

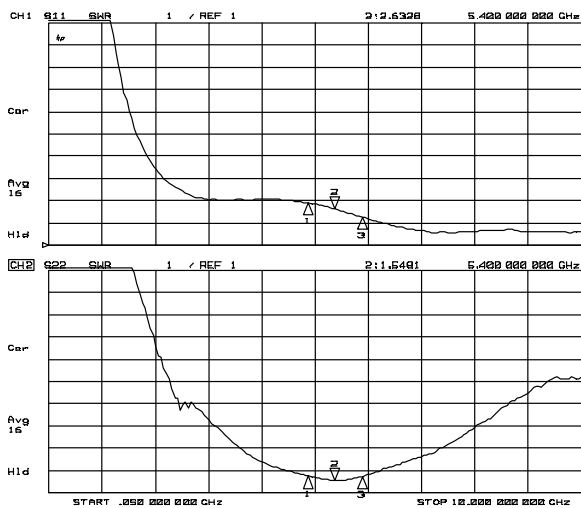

VSWRi, VSWRo (f=50MHz to 10GHz)

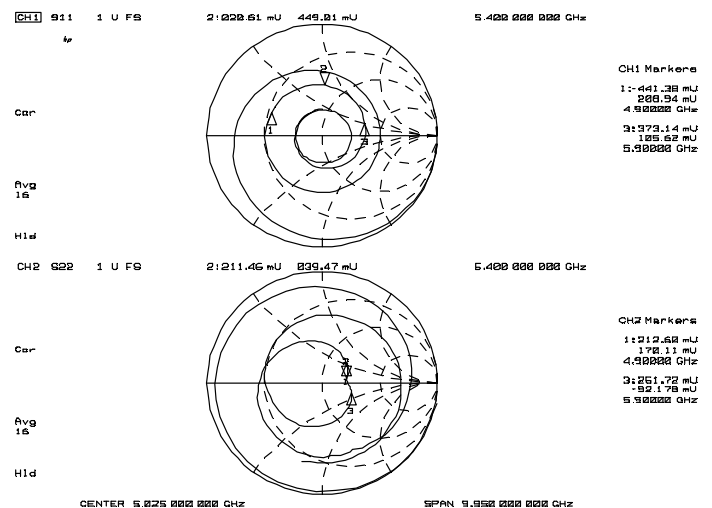

Zin, Zout (f=50MHz to 10GHz)

ELECTRICAL CHARACTERISTICS (RX Bypass mode)

$V_{CTL1}=3.3V, V_{CTL2}=V_{CTL3}=0V, Z_s=Z_l=50\Omega$

Loss vs. Ambient Temperature

($V_{CTL1}=3.3V, V_{CTL2}=V_{CTL3}=0V, f=5400MHz$)

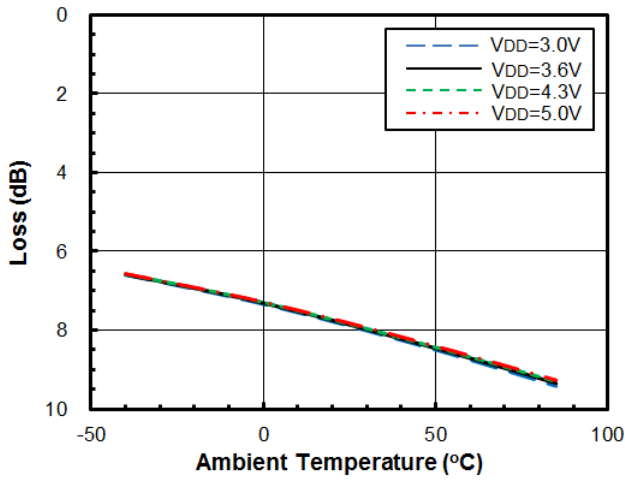

P-1dB(IN) vs. Ambient Temperature

($V_{CTL1}=3.3V, V_{CTL2}=V_{CTL3}=0V, f=5400MHz$)

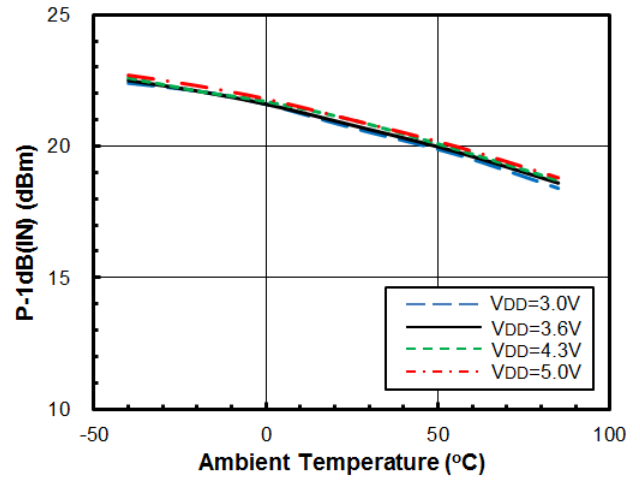

IIP3 vs. Ambient Temperature

($V_{CTL1}=3.3V, V_{CTL2}=V_{CTL3}=0V, f_1=5400MHz, f_2=f_1+100kHz, Pin=-10dBm$)

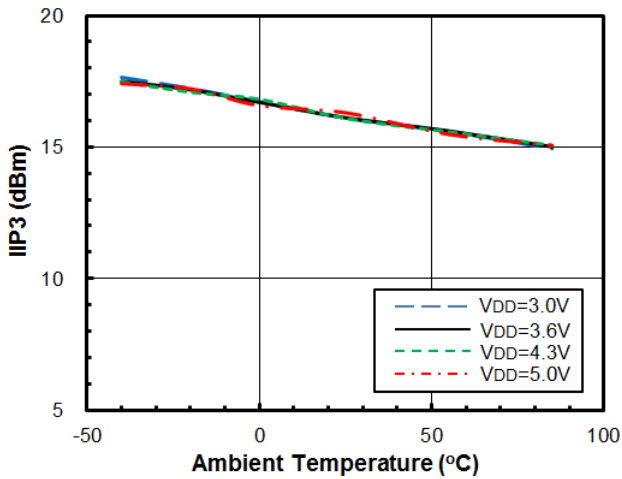

ANT Port Return Loss vs. Ambient Temperature

($V_{CTL1}=3.3V, V_{CTL2}=V_{CTL3}=0V, f=5400MHz$)

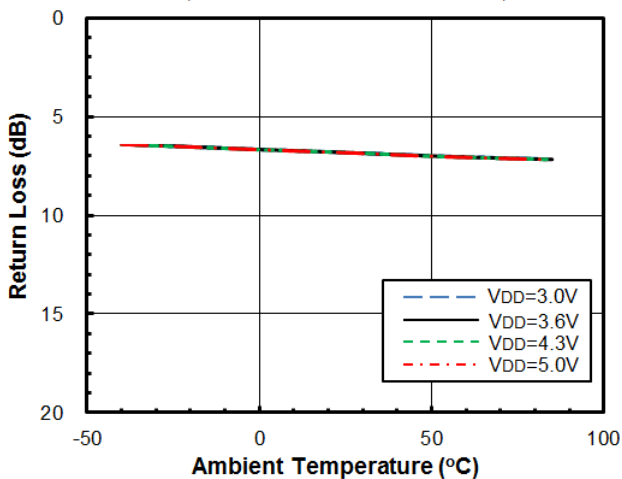

LNAOUT Port Return Loss vs. Ambient Temperature

($V_{CTL1}=3.3V, V_{CTL2}=V_{CTL3}=0V, f=5400MHz$)

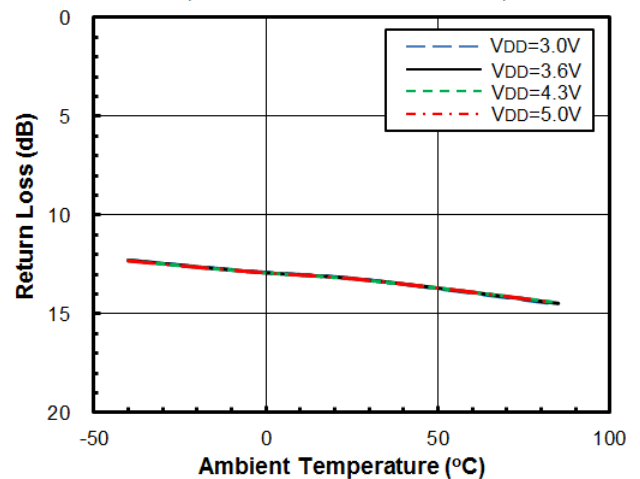

■ ELECTRICAL CHARACTERISTICS (TX mode)

$V_{DD}=3.6V$, $V_{CTL1}=V_{CTL3}=0V$, $V_{CTL2}=3.3V$, $T_a=+25^{\circ}C$, $Z_s=Z_l=50\Omega$

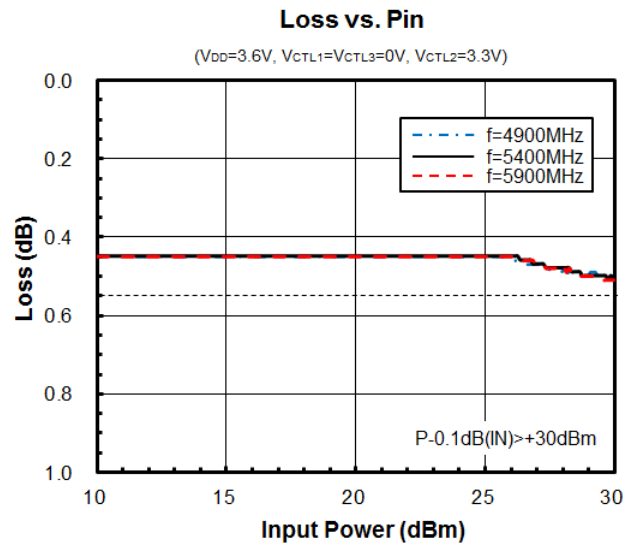
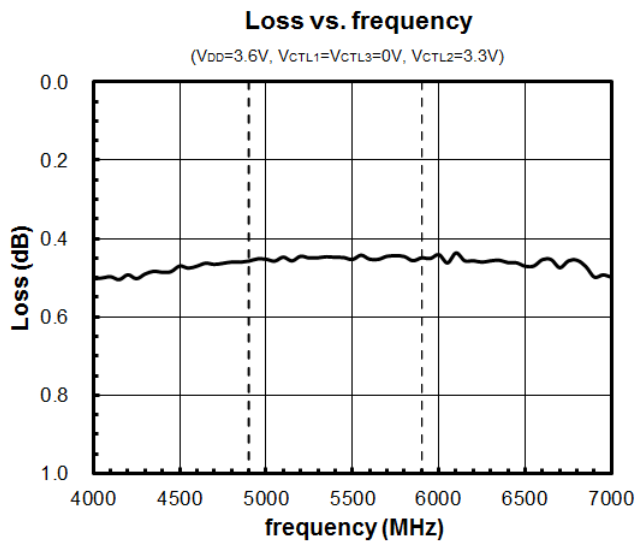

ELECTRICAL CHARACTERISTICS (TX mode)

$V_{DD}=3.6V$, $V_{CTL1}=V_{CTL3}=0V$, $V_{CTL2}=3.3V$, $T_a=+25^\circ C$, $Z_S=Z_L=50\Omega$

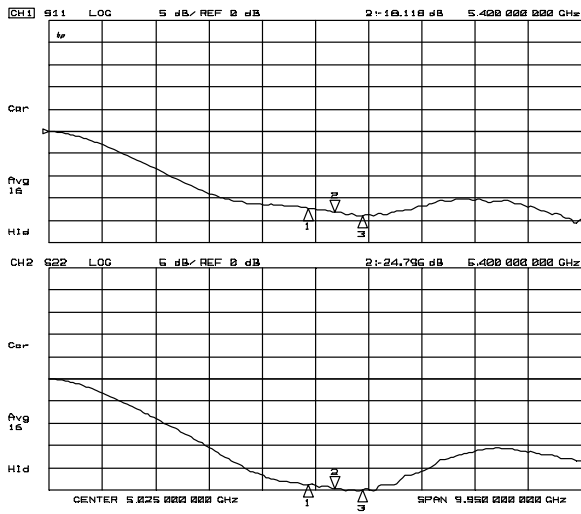

S11, S22 (f=50MHz to 10GHz)

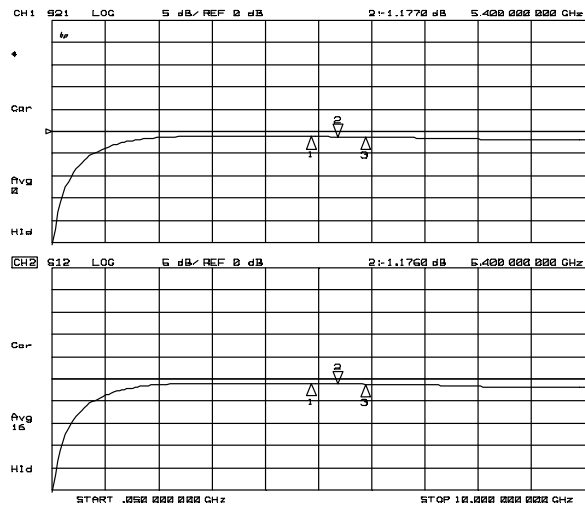

S21, S12 (f=50MHz to 10GHz)

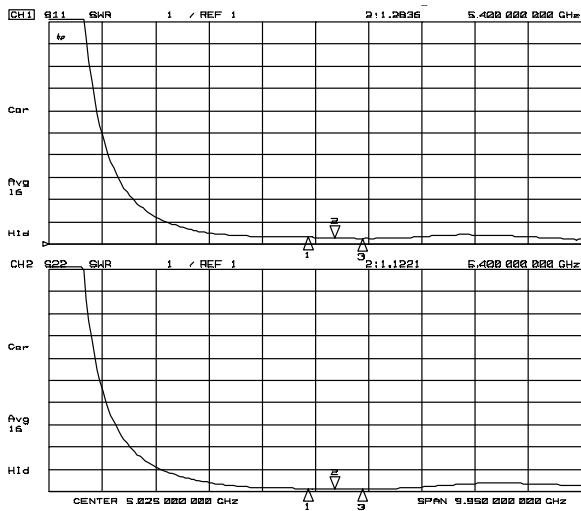

VSWRi, VSWRo (f=50MHz to 10GHz)

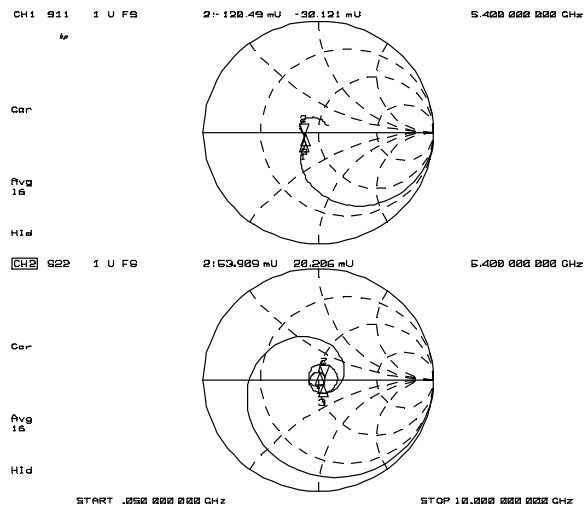

Zin, Zout (f=50MHz to 10GHz)

■ ELECTRICAL CHARACTERISTICS (TX mode)

$V_{DD}=3.6V$, $V_{CTL1}=V_{CTL3}=0V$, $V_{CTL2}=3.3V$, $Z_S=Z_I=50\Omega$

Loss vs. Ambient Temperature

($V_{DD}=3.6V$, $V_{CTL1}=V_{CTL3}=0V$, $V_{CTL2}=3.3V$, $f=5400MHz$)

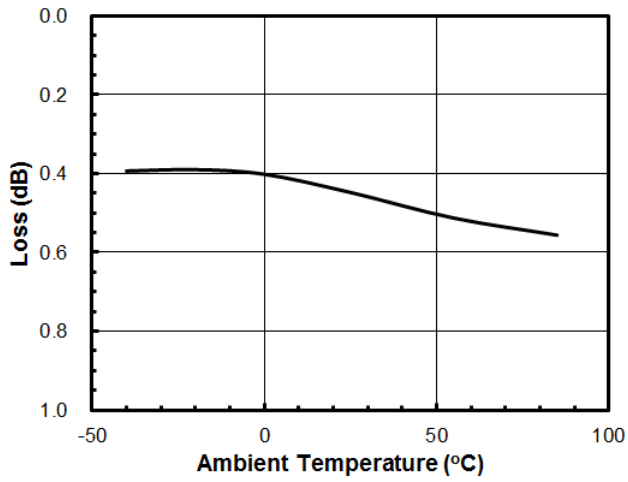

ANT Port Return Loss vs. Ambient Temperature

($V_{DD}=3.6V$, $V_{CTL1}=V_{CTL3}=0V$, $V_{CTL2}=3.3V$, $f=5400MHz$)

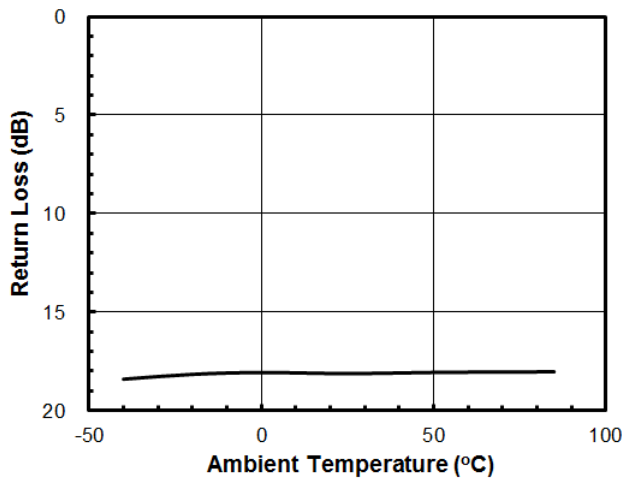

LNAOUT Port Return Loss vs. Ambient Temperature

($V_{DD}=3.6V$, $V_{CTL1}=V_{CTL3}=0V$, $V_{CTL2}=3.3V$, $f=5400MHz$)

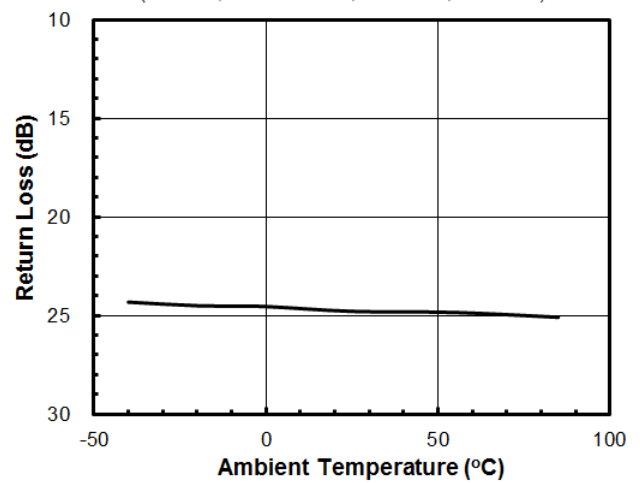

APPLICATION CIRCUIT

(TOP VIEW)

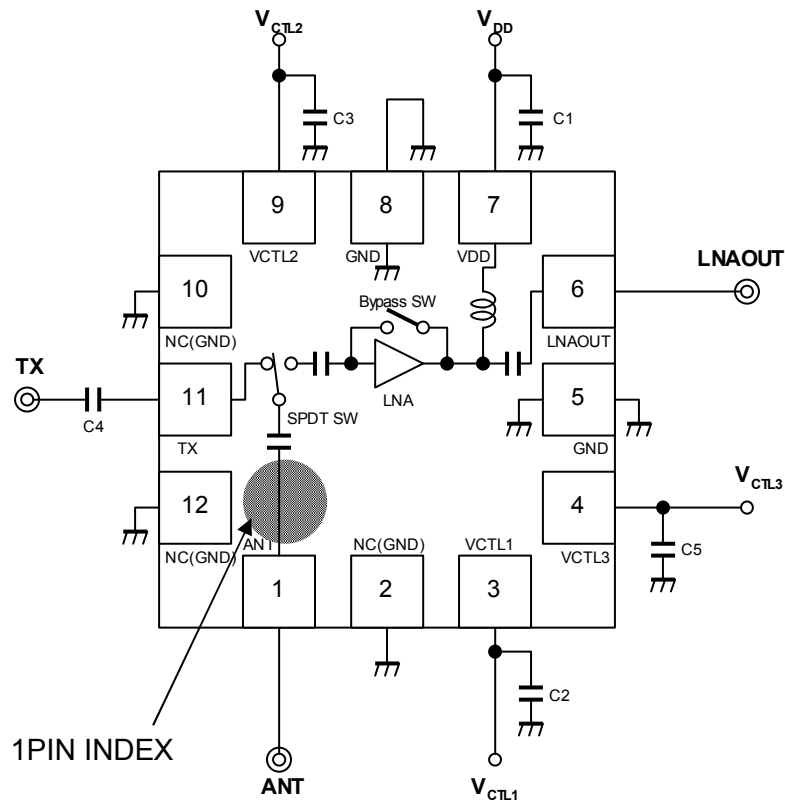

PARTS LIST

ID No.	Value	Notes
C1	0.1 μ F	Murata MFG (GRM03 series)
C2, C3, C5	10pF	
C4	27pF	

APPLIED CIRCUIT BOARD EXAMPLE

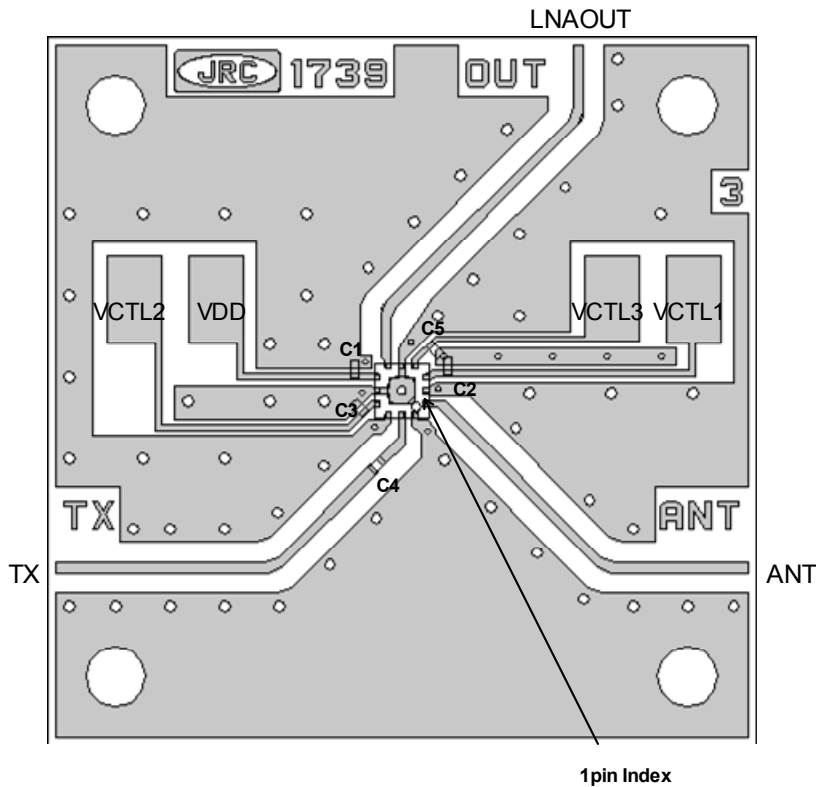

PCB Information

Substrate: FR-4
 Thickness: 0.2mm
 Microstrip line width: 0.37mm ($Z_0=50\Omega$)
 Size: 26.0mm x 26.0mm

<PCB LAYOUT GUIDELINE>

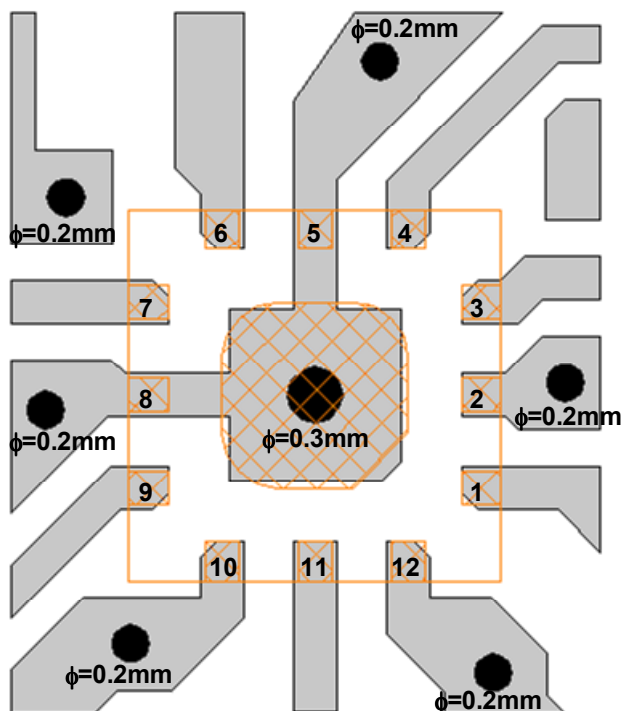

- PCB
- PKG Terminal
- PKG Outline
- GND Via Hole
Diameter: $\phi = 0.2 / 0.3$ mm

PRECAUTIONS

- [1] All external parts should be placed as close as possible to the IC.
- [2] For avoiding the degradation of RF performance, the bypass capacitor (C1) should be placed as close as possible to VDD terminal.
- [3] For good RF performance, the ground terminals must be placed possibly close to ground plane of substrate, and through holes for GND should be placed near by the pin connection.

RECOMMENDED FOOTPRINT PATTERN (QFN12-51 PACKAGE Reference)

PKG: 2.0mm x 2.0mm
Pin pitch: 0.5mm

: Land

: Mask (Open area) *Metal mask thickness: 100μm

: Resist (Open area)

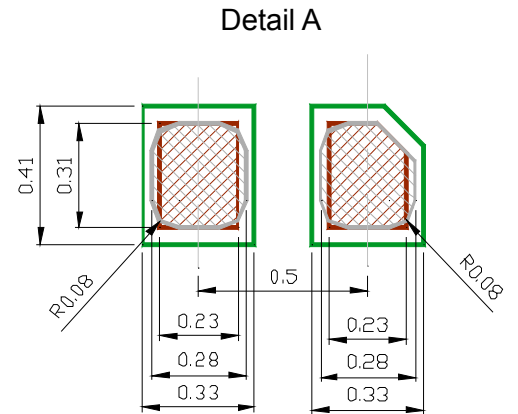
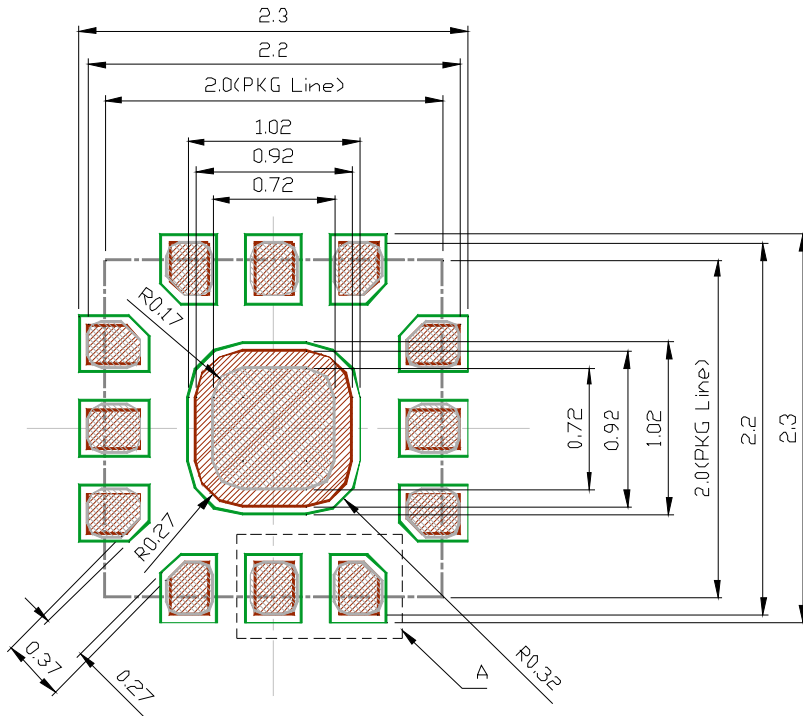

■ NOISE FIGURE MEASUREMENT BLOCK DIAGRAM

Measuring instruments

NF Analyzer : Agilent N8975A
 Noise Source : Agilent 346A

Setting the NF analyzer

Measurement mode form

Device under test : Amplifier
 System downconverter : off

Mode setup form

Sideband : LSB
 Averages : 16
 Average mode : Point
 Bandwidth : 4MHz
 Loss comp : off
 Tcold : setting the temperature of noise source (303K)

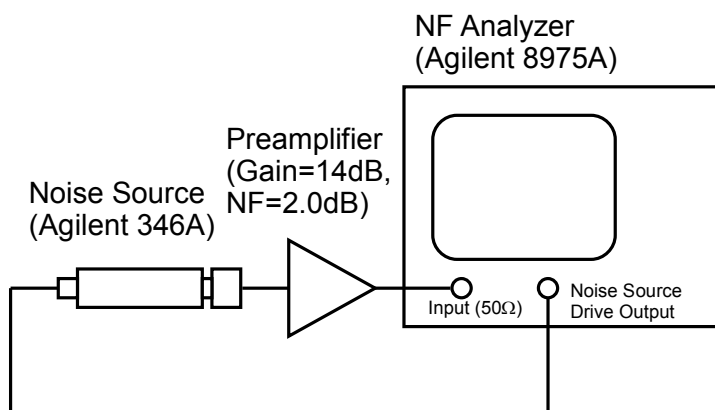

Calibration setup

- * Preamplifier is used to improve NF measurement accuracy.
- * Noise source, preamplifier and NF analyzer are connected directly.

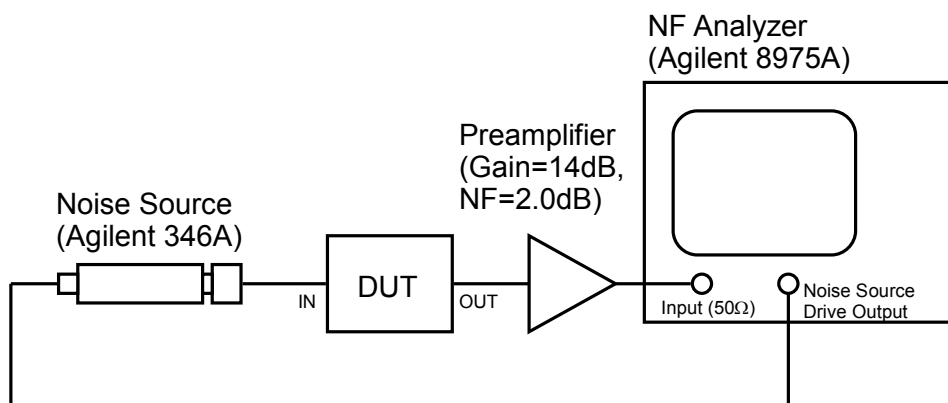

Measurement Setup

- * Noise source, DUT, preamplifier and NF analyzer are connected directly.

PACKAGE OUTLINE (QFN12-51)

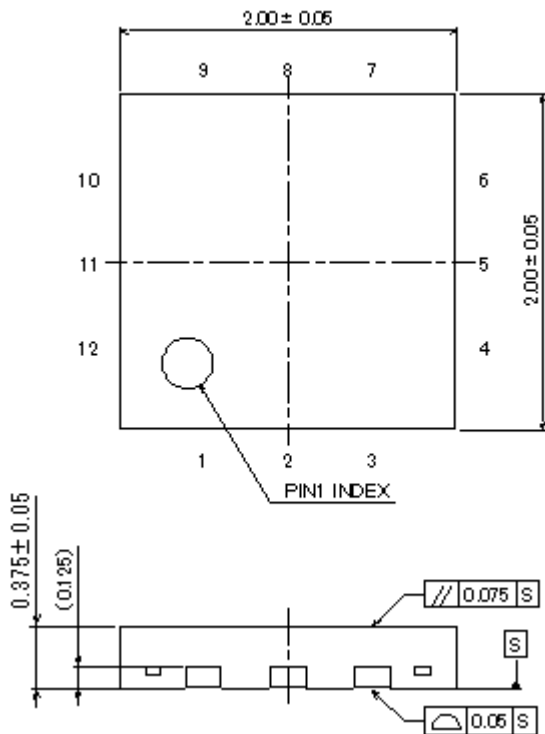

Unit	: mm
Board	: Copper
Terminal Treat	: Ni/Pd/Au plating
Molding Material	: Epoxy resin
Weight	: 4.7mg

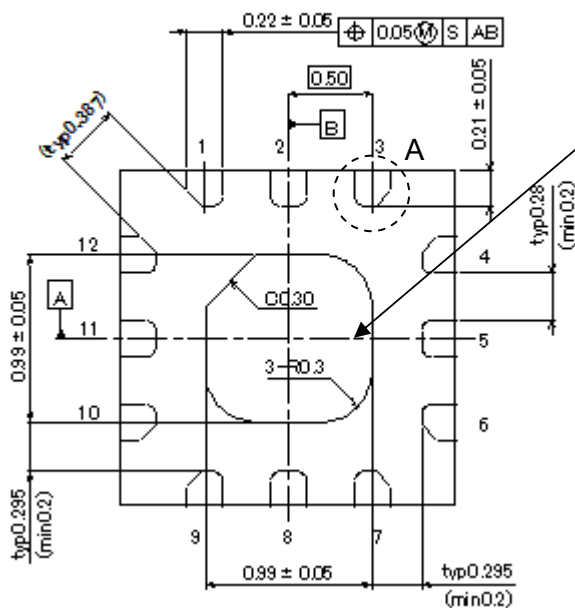

Exposed PAD
Ground connection is required.

Details of "A" part

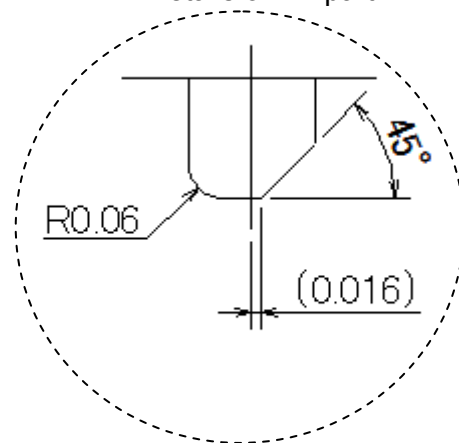

Cautions on using this product

- This product contains Gallium-Arsenide (GaAs) which is a harmful material.
- Do NOT eat or put into mouth.
 - Do NOT dispose in fire or break up this product.
 - Do NOT chemically make gas or powder with this product.
 - To waste this product, please obey the relating law of your country.

[CAUTION]

The specifications on this databook are only given for information, without any guarantee as regards either mistakes or omissions. The application circuits in this databook are described only to show representative usages of the product and not intended for the guarantee or permission of any right including the industrial rights.

This product may be damaged with electric static discharge (ESD) or spike voltage. Please handle with care to avoid these damages.

Mouser Electronics

Authorized Distributor

Click to View Pricing, Inventory, Delivery & Lifecycle Information:

[NJR:](#)

[NJG1739K51-TE1](#)



Компания «ЭлектроПласт» предлагает заключение долгосрочных отношений при поставках импортных электронных компонентов на взаимовыгодных условиях!

Наши преимущества:

- Оперативные поставки широкого спектра электронных компонентов отечественного и импортного производства напрямую от производителей и с крупнейших мировых складов;
- Поставка более 17-ти миллионов наименований электронных компонентов;
- Поставка сложных, дефицитных, либо снятых с производства позиций;
- Оперативные сроки поставки под заказ (от 5 рабочих дней);
- Экспресс доставка в любую точку России;
- Техническая поддержка проекта, помощь в подборе аналогов, поставка прототипов;
- Система менеджмента качества сертифицирована по Международному стандарту ISO 9001;
- Лицензия ФСБ на осуществление работ с использованием сведений, составляющих государственную тайну;
- Поставка специализированных компонентов (Xilinx, Altera, Analog Devices, Intersil, Interpoint, Microsemi, Aeroflex, Peregrine, Syfer, Eurofarad, Texas Instrument, Miteq, Cobham, E2V, MA-COM, Hittite, Mini-Circuits, General Dynamics и др.);

Помимо этого, одним из направлений компании «ЭлектроПласт» является направление «Источники питания». Мы предлагаем Вам помощь Конструкторского отдела:

- Подбор оптимального решения, техническое обоснование при выборе компонента;
- Подбор аналогов;
- Консультации по применению компонента;
- Поставка образцов и прототипов;
- Техническая поддержка проекта;
- Защита от снятия компонента с производства.



Как с нами связаться

Телефон: 8 (812) 309 58 32 (многоканальный)

Факс: 8 (812) 320-02-42

Электронная почта: org@eplast1.ru

Адрес: 198099, г. Санкт-Петербург, ул. Калинина, дом 2, корпус 4, литера А.