

Features

- Temperature ranges
 - Industrial: -40°C to 85°C
 - Automotive-E: -40°C to 125°C
- Pin and function compatible with CY7C199C
- High speed
 - $t_{AA} = 10$ ns (Industrial)
- Low active power
 - $I_{CC} = 80$ mA at 10 ns
- Low CMOS standby power
 - $I_{SB2} = 3$ mA
- 2.0V Data Retention
- Automatic power down when deselected
- CMOS for optimum speed/power
- TTL-compatible inputs and outputs
- Easy memory expansion with \overline{CE} and \overline{OE} features
- Available in Pb-free 28-pin 300-Mil wide Molded SOJ, 28-pin 300-Mil wide SOIC and 28-pin TSOP I packages

Functional Description

The CY7C199D is a high performance CMOS static RAM organized as 32,768 words by 8 bits. Easy memory expansion is provided by an active LOW Chip Enable (\overline{CE}), an active LOW Output Enable (\overline{OE}) and tri-state drivers. This device has an automatic power down feature, reducing the power consumption when deselected. The input and output pins (IO_0 through IO_7) are placed in a high impedance state when the device is deselected (\overline{CE} HIGH), the outputs are disabled (\overline{OE} HIGH), or during a write operation (\overline{CE} LOW and \overline{WE} LOW).

Write to the device by taking Chip Enable (\overline{CE}) and Write Enable (\overline{WE}) inputs LOW. Data on the eight IO pins (IO_0 through IO_7) is then written into the location specified on the address pins (A_0 through A_{14}).

Read from the device by taking Chip Enable (\overline{CE}) and Output Enable (\overline{OE}) LOW while forcing Write Enable (\overline{WE}) HIGH. Under these conditions, the contents of the memory location specified by the address pins appears on the IO pins.

For best practice recommendations, refer to the Cypress application note [AN1064, SRAM System Guidelines](#).

Logic Block Diagram

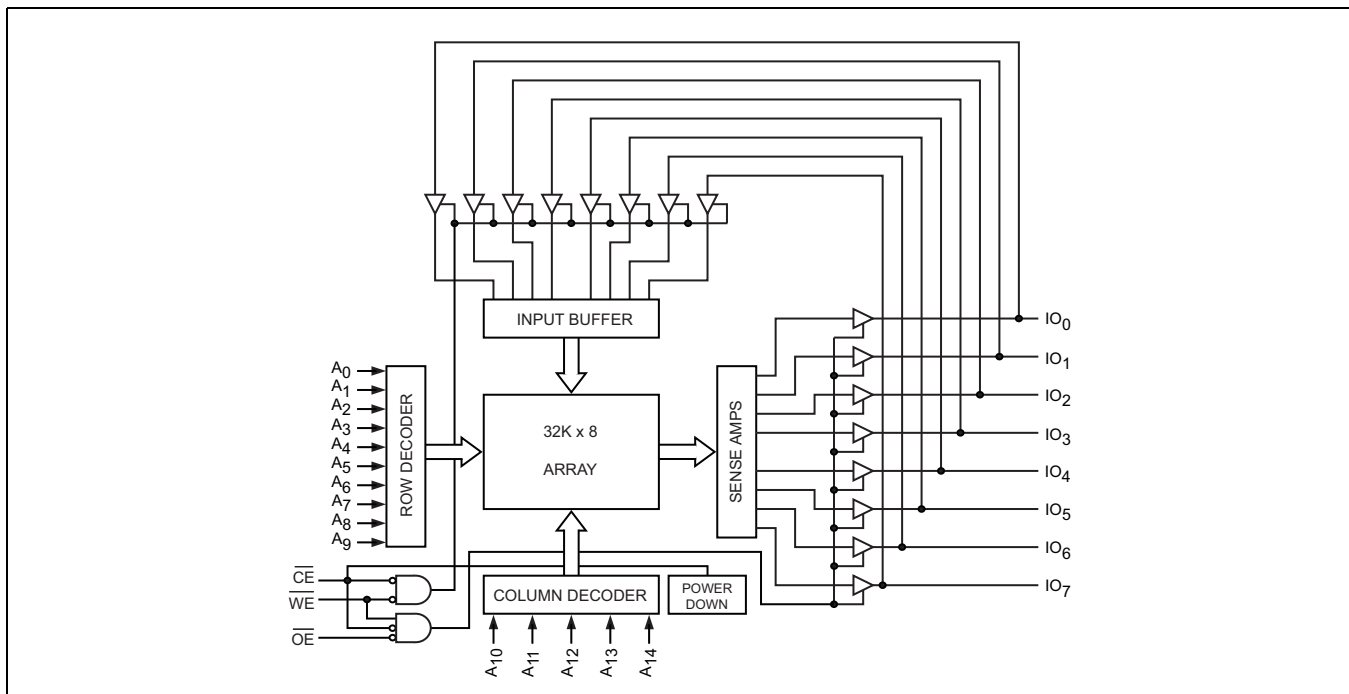

Pin Configuration

Figure 1. 28-Pin SOJ (Top View)

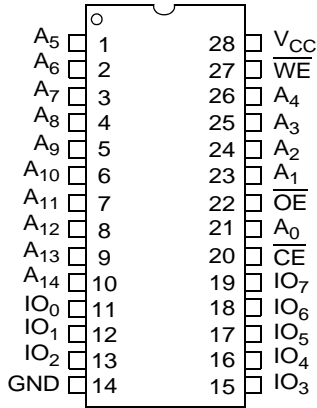

Figure 2. 28-Pin SOIC (Top View)

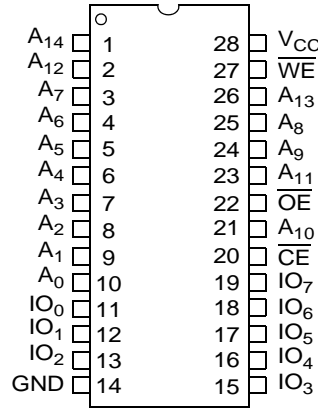
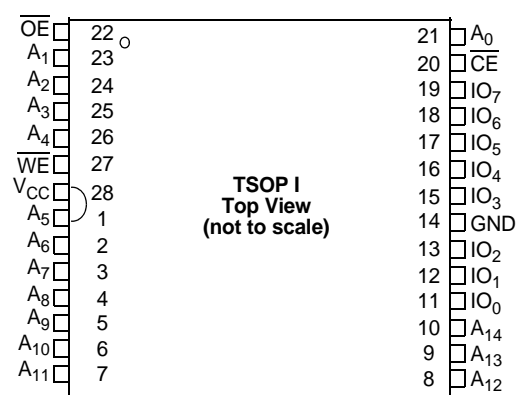

Figure 3. 28-Pin TSOP I (Top View)



Selection Guide

Description	-10 (Industrial)	-25 (Automotive) ^[1]	Unit
Maximum Access Time	10	25	ns
Maximum Operating Current	80	63	mA
Maximum CMOS Standby Current	3	15	mA

Note:

1. Automotive product information is preliminary

Maximum Ratings

Exceeding the maximum ratings may impair the useful life of the device. These user guidelines are not tested.

- Storage Temperature -65°C to +150°C
- Ambient Temperature with Power Applied -55°C to +125°C
- Supply Voltage on V_{CC} to Relative GND [2] -0.5V to +6.0V
- DC Voltage Applied to Outputs in High Z State [2] -0.5V to V_{CC} + 0.5V
- DC Input Voltage [2] -0.5V to V_{CC} + 0.5V

- Output Current into Outputs (LOW) 20 mA
- Static Discharge Voltage > 2,001V (per MIL-STD-883, Method 3015)
- Latch-up Current > 200 mA

Operating Range

Range	Ambient Temperature	V _{CC}	Speed
Industrial	-40°C to +85°C	5V ± 0.5V	10 ns
Automotive-E	-40°C to +125°C	5V ± 0.5V	25 ns

Electrical Characteristics

Over the Operating Range

Parameter	Description	Test Conditions	7C199D-10		7C199D-25		Unit
			Min	Max	Min	Max	
V _{OH}	Output HIGH Voltage	I _{OH} =-4.0 mA	2.4		2.4		V
V _{OL}	Output LOW Voltage	I _{OL} =8.0 mA		0.4		0.4	V
V _{IH}	Input HIGH Voltage [2]		2.2	V _{CC} + 0.5	2.2	V _{CC} + 0.5	V
V _{IL}	Input LOW Voltage [2]		-0.5	0.8	-0.5	0.8	V
I _{IX}	Input Leakage Current	GND ≤ V _I ≤ V _{CC}	-1	+1	-5	+5	μA
I _{OZ}	Output Leakage Current	GND ≤ V _O ≤ V _{CC} , Output Disabled	-1	+1	-5	+5	μA
I _{CC}	V _{CC} Operating Supply Current	V _{CC} = Max, I _{OUT} = 0 mA, f = f _{max} = 1/t _{RC}	100 MHz	80	-	-	mA
			83 MHz	72	-	-	mA
			66 MHz	58	-	-	mA
			40 MHz	37	63	63	mA
I _{SB1}	Automatic CE Power down Current—TTL Inputs	Max V _{CC} , $\overline{CE} \geq V_{IH}$, V _{IN} ≥ V _{IH} or V _{IN} ≤ V _{IL} , f = f _{max}		10		50	mA
I _{SB2}	Automatic CE Power down Current—CMOS Inputs	Max V _{CC} , $\overline{CE} \geq V_{CC} - 0.3V$, V _{IN} ≥ V _{CC} - 0.3V or V _{IN} ≤ 0.3V, f = 0		3		15	mA

Note:

2. V_{IL}(min) = -2.0V and V_{IH}(max) = V_{CC} + 1V for pulse durations of less than 5 ns.

Capacitance [3]

Parameter	Description	Test Conditions	Max	Unit
C _{IN}	Input Capacitance	T _A = 25°C, f = 1 MHz, V _{CC} = 5.0V	8	pF
C _{OUT}	Output Capacitance		8	pF

Thermal Resistance [3]

Parameter	Description	Test Conditions	SOJ	TSOP I	SOIC	Unit
Θ _{JA}	Thermal Resistance (Junction to Ambient)	Still Air, soldered on a 3 x 4.5 inch, four-layer printed circuit board	59.16	54.65	TBD	°C/W
Θ _{JC}	Thermal Resistance (Junction to Case)		40.84	21.49	TBD	°C/W

AC Test Loads and Waveforms [4]

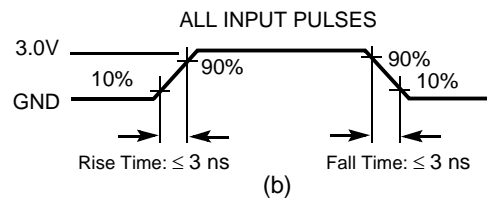
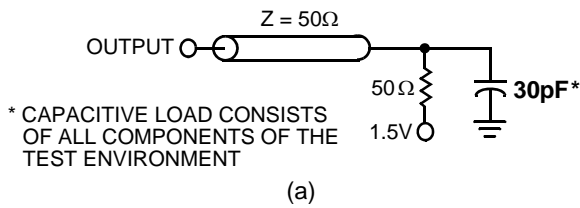

High Z characteristics:

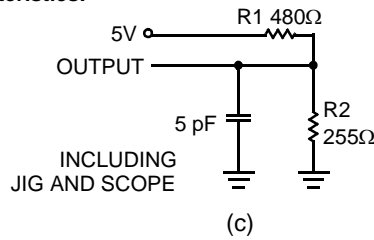

Notes:

- Tested initially and after any design or process changes that may affect these parameters.
- AC characteristics (except High Z) are tested using the load conditions shown in Figure (a). High Z characteristics are tested for all speeds using the test load shown in Figure (c).

Switching Characteristics (Over the Operating Range) ^[5]

Parameter	Description	7C199D-10		7C199D-25		Unit
		Min	Max	Min	Max	
Read Cycle						
$t_{\text{power}}^{[6]}$	V_{CC} (typical) to the first access	100		100		μs
t_{RC}	Read Cycle Time	10		25		ns
t_{AA}	Address to Data Valid		10		25	ns
t_{OHA}	Data Hold from Address Change	3		3		ns
t_{ACE}	$\overline{\text{CE}}$ LOW to Data Valid		10		25	ns
t_{DOE}	$\overline{\text{OE}}$ LOW to Data Valid		5		10	ns
$t_{\text{LZOE}}^{[7]}$	$\overline{\text{OE}}$ LOW to Low Z	0		0		ns
$t_{\text{HZOE}}^{[7, 8]}$	$\overline{\text{OE}}$ HIGH to High Z		5		11	ns
$t_{\text{LZCE}}^{[7]}$	$\overline{\text{CE}}$ LOW to Low Z	3		3		ns
$t_{\text{HZCE}}^{[7, 8]}$	$\overline{\text{CE}}$ HIGH to High Z		5		11	ns
$t_{\text{PU}}^{[9]}$	$\overline{\text{CE}}$ LOW to Power up	0		0		ns
$t_{\text{PD}}^{[9]}$	$\overline{\text{CE}}$ HIGH to Power down		10		25	ns
Write Cycle ^[10, 11]						
t_{WC}	Write Cycle Time	10		25		ns
t_{SCE}	$\overline{\text{CE}}$ LOW to Write End	7		18		ns
t_{AW}	Address Setup to Write End	7		18		ns
t_{HA}	Address Hold from Write End	0		0		ns
t_{SA}	Address Setup to Write Start	0		0		ns
t_{PWE}	$\overline{\text{WE}}$ Pulse Width	7		18		ns
t_{SD}	Data Setup to Write End	6		12		ns
t_{HD}	Data Hold from Write End	0		0		ns
$t_{\text{HZWE}}^{[7]}$	$\overline{\text{WE}}$ LOW to High Z		5		11	ns
$t_{\text{LZWE}}^{[7, 8]}$	$\overline{\text{WE}}$ HIGH to Low Z	3		3		ns

Notes:

- Test conditions assume signal transition time of 3 ns or less for all speeds, timing reference levels of 1.5V, input pulse levels of 0 to 3.0V, and output loading of the specified $I_{\text{OL}}/I_{\text{OH}}$ and 30-pF load capacitance.
- t_{POWER} gives the minimum amount of time that the power supply should be at typical V_{CC} values until the first memory access can be performed.
- At any given temperature and voltage condition, t_{HZCE} is less than t_{LZCE} , t_{HZOE} is less than t_{LZOE} , and t_{HZWE} is less than t_{LZWE} for any given device.
- t_{HZOE} , t_{HZCE} , and t_{HZWE} are specified with $C_{\text{L}} = 5 \text{ pF}$ as in part (b) of "AC Test Loads and Waveforms ^[4]" on page 4. Transition is measured $\pm 200 \text{ mV}$ from steady-state voltage.
- This parameter is guaranteed by design and is not tested.
- The internal write time of the memory is defined by the overlap of $\overline{\text{CE}}$ LOW and $\overline{\text{WE}}$ LOW. Both signals must be LOW to initiate a write and either signal can terminate a write by going HIGH. The data input setup and hold timing should be referenced to the rising edge of the signal that terminates the write.
- The minimum write cycle time for Write Cycle No. 3 (WE controlled, OE LOW) is the sum of t_{HZWE} and t_{SD} .

Data Retention Characteristics (Over the Operating Range)

Parameter	Description	Conditions	Min	Max	Unit
V_{DR}	V_{CC} for Data Retention		2.0		V
I_{CCDR}	Data Retention Current	$V_{CC} = V_{DR} = 2.0V, \overline{CE} \geq V_{CC} - 0.3V,$ $V_{IN} \geq V_{CC} - 0.3V$ or $V_{IN} \leq 0.3V$	Industrial	3	mA
			Automotive-E	15	mA
$t_{CDR}^{[3]}$	Chip Deselect to Data Retention Time		0		ns
$t_R^{[12]}$	Operation Recovery Time		t_{RC}		ns

Data Retention Waveform

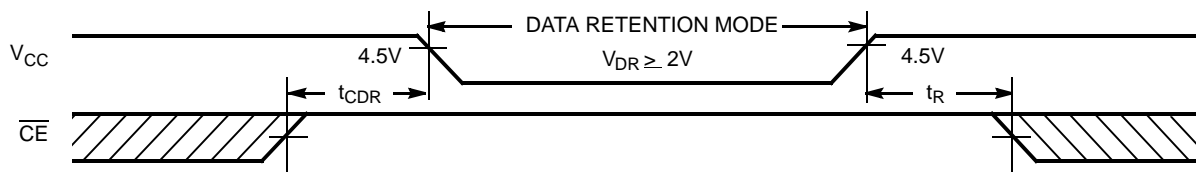

Switching Waveforms

Read Cycle No. 1 (Address Transition Controlled) [13, 14]

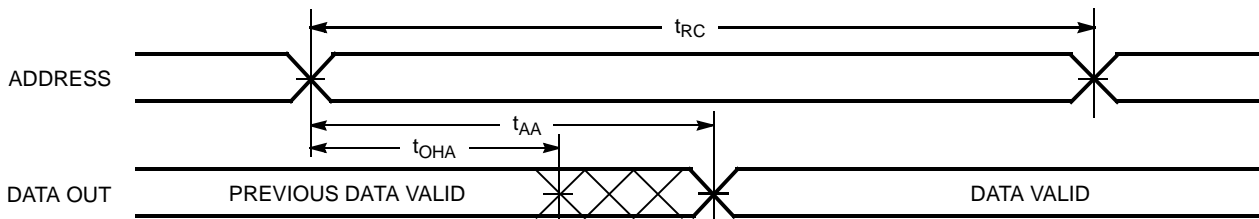

Read Cycle No. 2 (\overline{OE} Controlled) [14, 15]

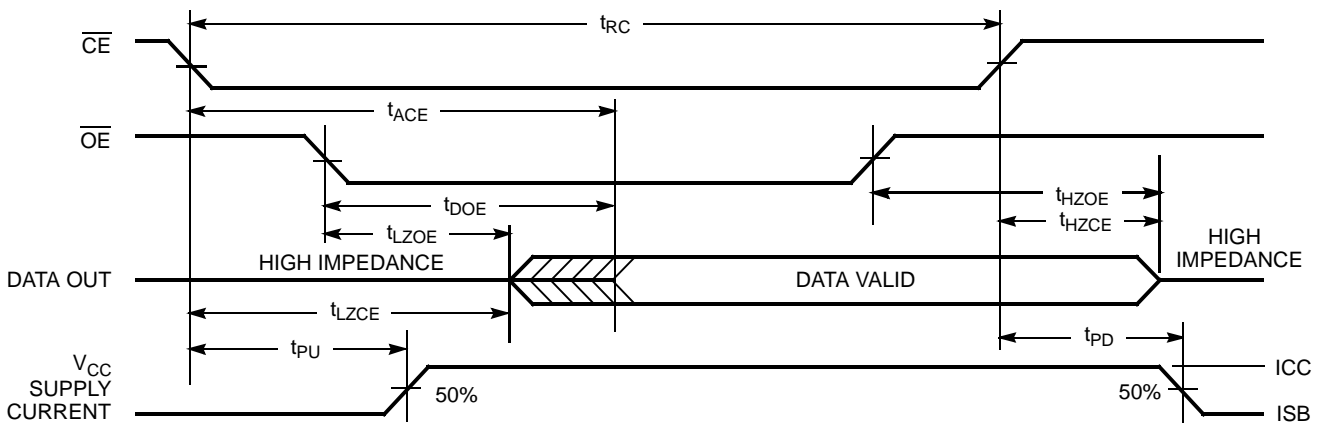

Notes:

- 12. Full device operation requires linear V_{CC} ramp from V_{DR} to $V_{CC(min)} \geq 50 \mu s$ or stable at $V_{CC(min)} \geq 50 \mu s$.
- 13. Device is continuously selected. $\overline{OE}, \overline{CE} = V_{IL}$.
- 14. \overline{WE} is HIGH for read cycle.
- 15. Address valid prior to or coincident with \overline{CE} transition LOW.

Switching Waveforms (continued)

Write Cycle No. 1 (\overline{CE} Controlled) [10, 16, 17]

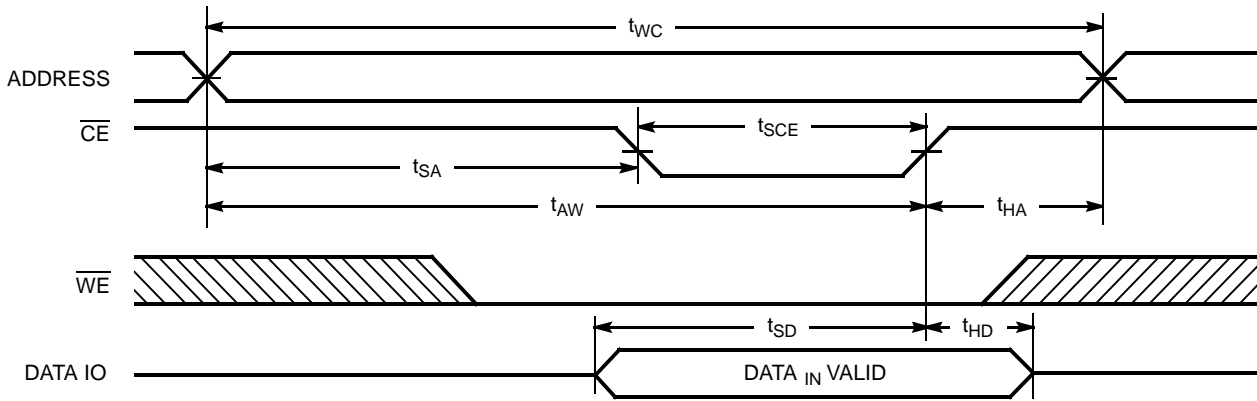

Write Cycle No. 2 (\overline{WE} Controlled) [10, 16, 17]

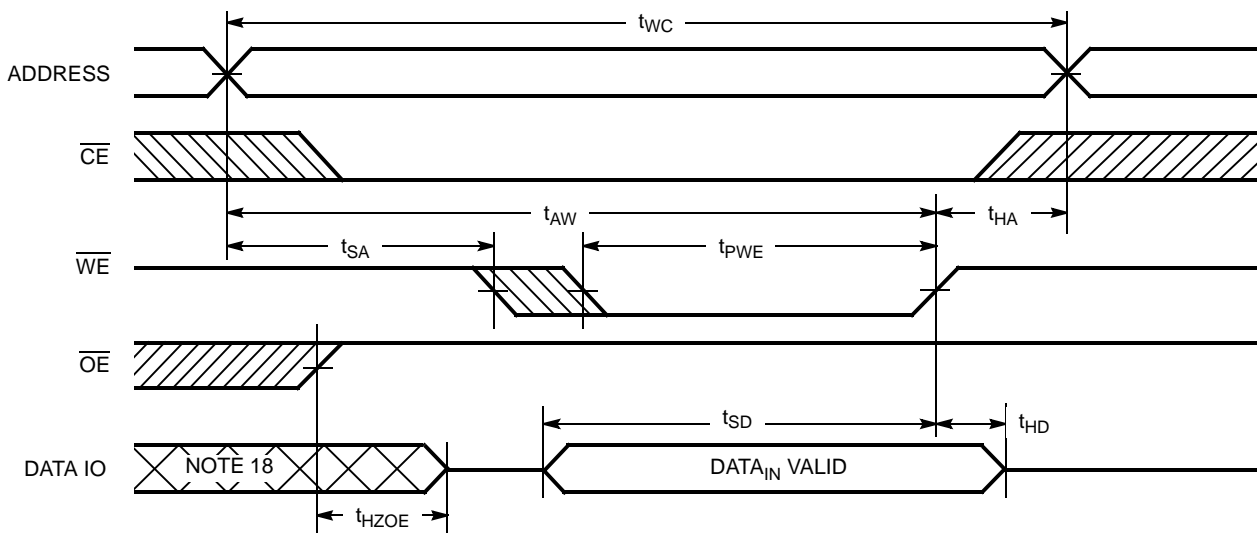

Write Cycle No. 3 (\overline{WE} Controlled, \overline{OE} LOW) [11, 17]

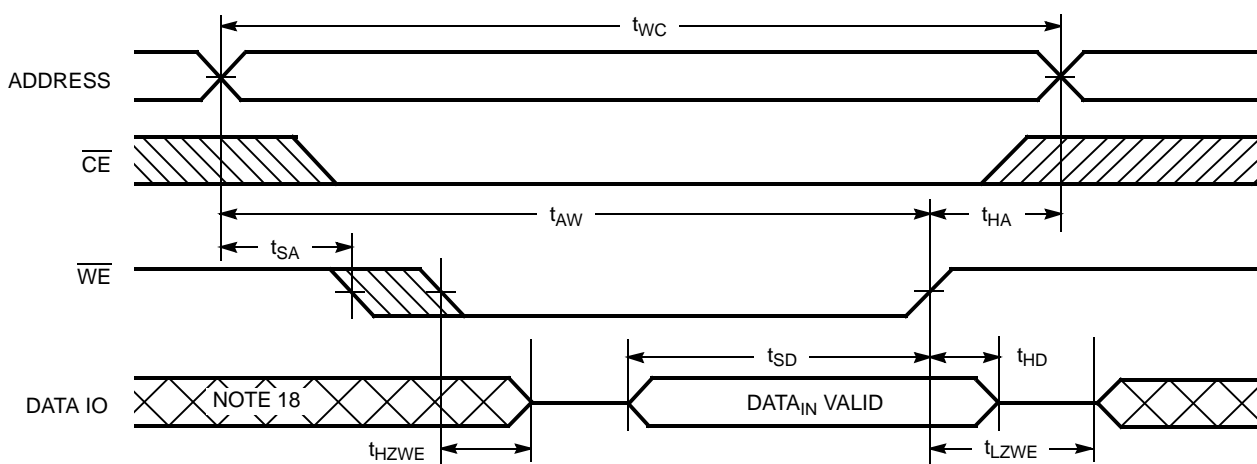

Notes:

- 16. Data IO is high impedance if $\overline{OE} = V_{IH}$.
- 17. If \overline{CE} goes HIGH simultaneously with \overline{WE} HIGH, the output remains in a high-impedance state.
- 18. During this period the IOs are in the output state and input signals should not be applied.

Truth Table

CE	WE	OE	Inputs/Outputs	Mode	Power
H	X	X	High Z	Deselect/Power down	Standby (I _{SB})
L	H	L	Data Out	Read	Active (I _{CC})
L	L	X	Data In	Write	Active (I _{CC})
L	H	H	High Z	Deselect, Output disabled	Active (I _{CC})

Ordering Information

Speed (ns)	Ordering Code	Package Diagram	Package Type	Operating Range
10	CY7C199D-10VXI	51-85031	28-pin (300-Mil) Molded SOJ (Pb-Free)	Industrial
	CY7C199D-10ZXI	51-85071	28-pin TSOP Type I (Pb-free)	
25	CY7C199D-25SXE	51-85026	28-pin (300-Mil) SOIC (Pb-Free)	Automotive-E

Please contact your local Cypress sales representative for availability of these parts.

Package Diagrams

Figure 4. 28-Pin (300-Mil) Molded SOJ

NOTE:

1. JEDEC STD REF MO088
2. BODY LENGTH DIMENSION DOES NOT INCLUDE MOLD PROTRUSION/END FLASH
MOLD PROTRUSION/END FLASH SHALL NOT EXCEED 0.006 in (0.152 mm) PER SIDE
3. DIMENSIONS IN INCHES
MIN.
MAX.

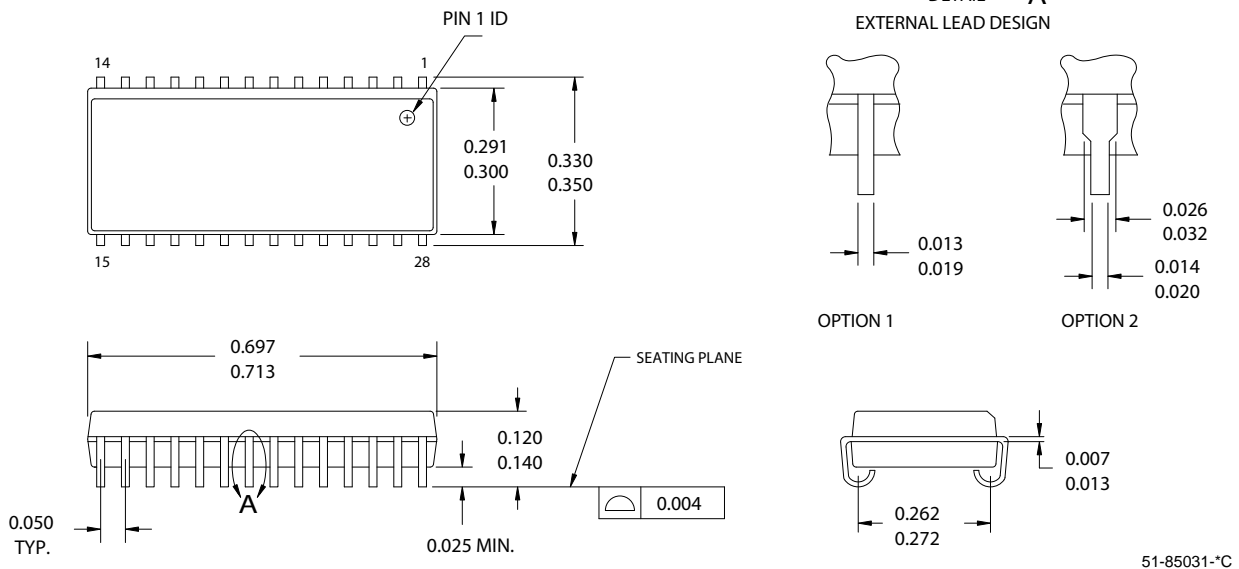

Package Diagrams (continued)

Figure 5. 28-Pin (300-Mil) SOIC

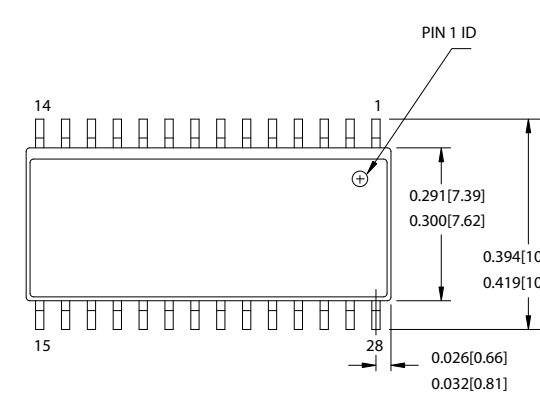

NOTE:

1. JEDEC STD REF MO-119
2. BODY LENGTH DIMENSION DOES NOT INCLUDE MOLD PROTRUSION/END FLASH, BUT DOES INCLUDE MOLD MISMATCH AND ARE MEASURED AT THE MOLD PARTING LINE. MOLD PROTRUSION/END FLASH SHALL NOT EXCEED 0.010 in (0.254 mm) PER SIDE
3. DIMENSIONS IN INCHES
MIN.
MAX.
4. PACKAGE WEIGHT 0.85gms

PART #	
S28.3	STANDARD PKG.
SZ28.3	LEAD FREE PKG.

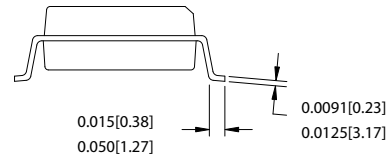
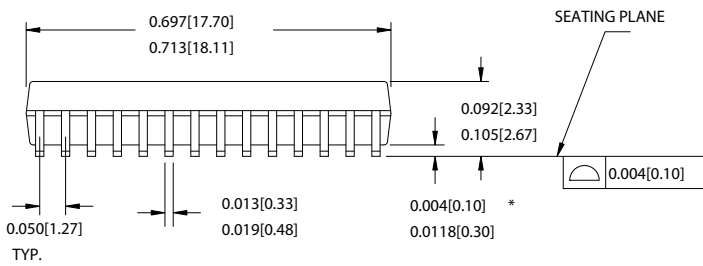

51-85026-*D

Package Diagrams (continued)

Figure 6. 28-Pin Thin Small Outline Package Type 1 (8x13.4 mm)

NOTE: ORIENTATION I.D. MAY BE LOCATED EITHER AS SHOWN IN OPTION 1 OR OPTION 2

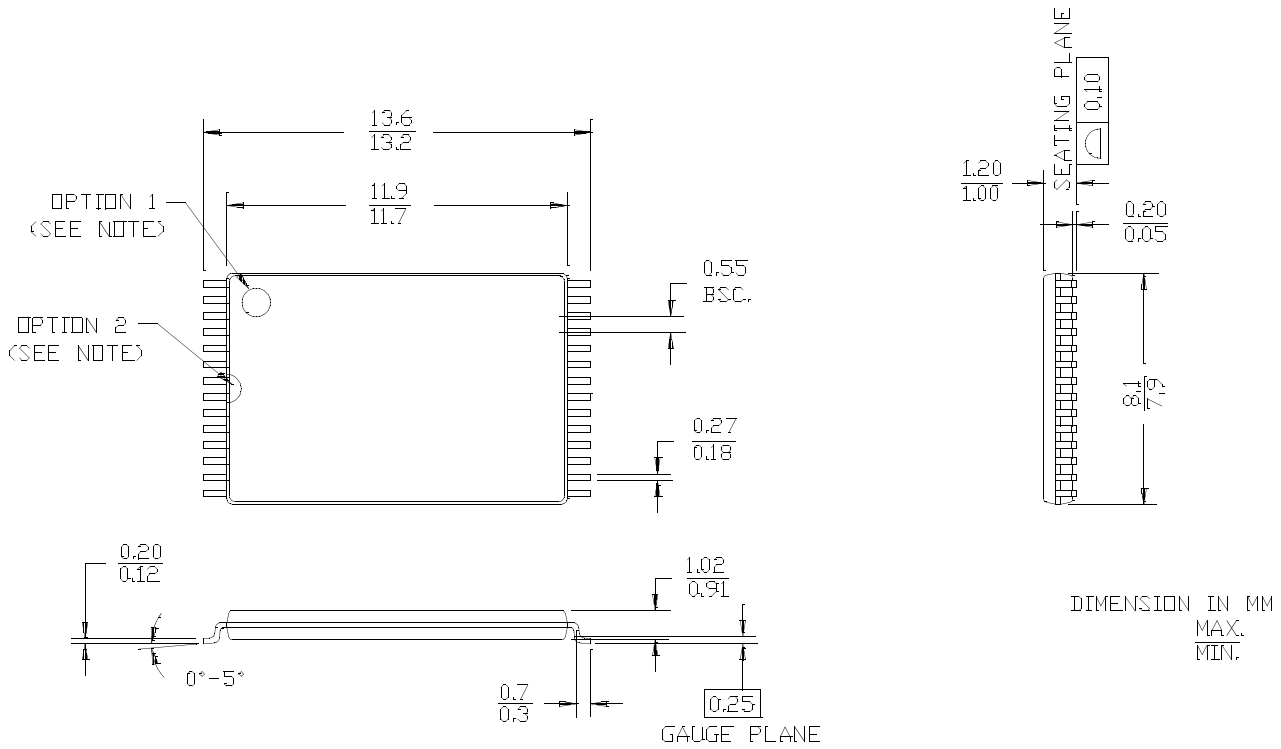

51-85071-G

Document History Page

Document Title: CY7C199D 256K (32K x 8) Static RAM Document Number: 38-05471				
Revision	ECN	Orig. of Change	Submission Date	Description of Change
**	201560	SWI	See ECN	Advance Information datasheet for C9 IPP
*A	233728	RKF	See ECN	DC parameters modified as per EROS (Spec # 01-02165) Pb-free Offering in Ordering Information
*B	262950	RKF	See ECN	Removed 28-LCC Pinout and Package Diagrams Added Data Retention Characteristics table Added T _{power} Spec in Switching Characteristics table Shaded Ordering Information
*C	307594	RKF	See ECN	Reduced Speed bins to -10, -12 and -15 ns
*D	820660	VKN	See ECN	Converted from Preliminary to Final Removed 12 ns and 15 ns speed bin Removed Commercial Operating range Removed "L" part Removed 28-pin PDIP and 28-pin SOIC package Changed Overshoot spec from V _{CC} +2V to V _{CC} +1V in footnote #2 Changed I _{CC} spec from 60 mA to 80 mA for 100 MHz speed bin Added I _{CC} specs for 83 MHz, 66 MHz and 40 MHz speed bins Updated Thermal Resistance table Updated Ordering Information Table
*E	2745093	VKN	See ECN	Included 28-Pin SOIC package Changed V _{IH} level from 2.0V to 2.2V For Industrial grade, changed t _{SD} from 5 ns to 6 ns, and t _{HZWE} from 6 ns to 5 ns Included Automotive-E information

Sales, Solutions, and Legal Information

Worldwide Sales and Design Support

Cypress maintains a worldwide network of offices, solution centers, manufacturer's representatives, and distributors. To find the office closest to you, visit us at cypress.com/sales

Products

PSoC	psoc.cypress.com
Clocks & Buffers	clocks.cypress.com
Wireless	wireless.cypress.com
Memories	memory.cypress.com
Image Sensors	image.cypress.com

© Cypress Semiconductor Corporation, 2004-2009. The information contained herein is subject to change without notice. Cypress Semiconductor Corporation assumes no responsibility for the use of any circuitry other than circuitry embodied in a Cypress product. Nor does it convey or imply any license under patent or other rights. Cypress products are not warranted nor intended to be used for medical, life support, life saving, critical control or safety applications, unless pursuant to an express written agreement with Cypress. Furthermore, Cypress does not authorize its products for use as critical components in life-support systems where a malfunction or failure may reasonably be expected to result in significant injury to the user. The inclusion of Cypress products in life-support systems application implies that the manufacturer assumes all risk of such use and in doing so indemnifies Cypress against all charges.

Any Source Code (software and/or firmware) is owned by Cypress Semiconductor Corporation (Cypress) and is protected by and subject to worldwide patent protection (United States and foreign), United States copyright laws and international treaty provisions. Cypress hereby grants to licensee a personal, non-exclusive, non-transferable license to copy, use, modify, create derivative works of, and compile the Cypress Source Code and derivative works for the sole purpose of creating custom software and or firmware in support of licensee product to be used only in conjunction with a Cypress integrated circuit as specified in the applicable agreement. Any reproduction, modification, translation, compilation, or representation of this Source Code except as specified above is prohibited without the express written permission of Cypress.

Disclaimer: CYPRESS MAKES NO WARRANTY OF ANY KIND, EXPRESS OR IMPLIED, WITH REGARD TO THIS MATERIAL, INCLUDING, BUT NOT LIMITED TO, THE IMPLIED WARRANTIES OF MERCHANTABILITY AND FITNESS FOR A PARTICULAR PURPOSE. Cypress reserves the right to make changes without further notice to the materials described herein. Cypress does not assume any liability arising out of the application or use of any product or circuit described herein. Cypress does not authorize its products for use as critical components in life-support systems where a malfunction or failure may reasonably be expected to result in significant injury to the user. The inclusion of Cypress' product in a life-support systems application implies that the manufacturer assumes all risk of such use and in doing so indemnifies Cypress against all charges.

Use may be limited by and subject to the applicable Cypress software license agreement.



Компания «ЭлектроПласт» предлагает заключение долгосрочных отношений при поставках импортных электронных компонентов на взаимовыгодных условиях!

Наши преимущества:

- Оперативные поставки широкого спектра электронных компонентов отечественного и импортного производства напрямую от производителей и с крупнейших мировых складов;
- Поставка более 17-ти миллионов наименований электронных компонентов;
- Поставка сложных, дефицитных, либо снятых с производства позиций;
- Оперативные сроки поставки под заказ (от 5 рабочих дней);
- Экспресс доставка в любую точку России;
- Техническая поддержка проекта, помощь в подборе аналогов, поставка прототипов;
- Система менеджмента качества сертифицирована по Международному стандарту ISO 9001;
- Лицензия ФСБ на осуществление работ с использованием сведений, составляющих государственную тайну;
- Поставка специализированных компонентов (Xilinx, Altera, Analog Devices, Intersil, Interpoint, Microsemi, Aeroflex, Peregrine, Syfer, Eurofarad, Texas Instrument, Miteq, Cobham, E2V, MA-COM, Hittite, Mini-Circuits, General Dynamics и др.);

Помимо этого, одним из направлений компании «ЭлектроПласт» является направление «Источники питания». Мы предлагаем Вам помощь Конструкторского отдела:

- Подбор оптимального решения, техническое обоснование при выборе компонента;
- Подбор аналогов;
- Консультации по применению компонента;
- Поставка образцов и прототипов;
- Техническая поддержка проекта;
- Защита от снятия компонента с производства.



Как с нами связаться

Телефон: 8 (812) 309 58 32 (многоканальный)

Факс: 8 (812) 320-02-42

Электронная почта: org@eplast1.ru

Адрес: 198099, г. Санкт-Петербург, ул. Калинина, дом 2, корпус 4, литера А.