

General-purpose, low voltage rail-to-rail output operational amplifiers

Datasheet - production data



Applications

- Battery-powered applications
- Portable devices
- Signal conditioning
- Active filtering
- Medical instrumentation

Description

The LMX3xx series is a set of single, dual, and quad low-voltage, general-purpose, operational amplifiers. These devices can operate from 2.3 V to 5.5 V with a typical current consumption of 120 μ A per channel. The LMX3xx series offers a rail-to-rail output and an input common-mode voltage that includes ground.

The LMX3xx series also exhibits a 1.3 MHz gain bandwidth and they can drive capacitive loads. The devices are stable while operating at unity gain. They are offered with industry standard pinouts in tiny packages.

Features

- Low power consumption: 120 μ A at 2.7 V
- Low supply voltage: 2.3 V - 5.5 V
- Rail-to-rail output swing
- Gain bandwidth product: 1.3 MHz
- Extended temperature range: -40 °C to 125 °C
- No crossover distortion
- No phase reversal
- Tiny packages

Related products

- See the TSV85x series for higher accuracy, stand-by options, and smaller packages

Table 1. Device summary

Reference	Single	Dual	Quad
LMX3xx	LMX321	LMX358	LMX324

Contents

1	Package pin connections	3
2	Absolute maximum ratings and operating conditions	4
3	Electrical characteristics	5
4	Application information	13
4.1	Operating voltages	13
4.2	Input common-mode range	13
4.3	Rail-to-rail output	13
4.4	Input offset voltage drift over temperature	13
4.5	PCB layouts	13
4.6	Macromodel	13
5	Package information	14
5.1	SC70-5 (or SOT323-5) package information	15
5.2	SOT23-5 package information	16
5.3	DFN8 2x2 package information	17
5.4	MiniSO8 package information	19
5.5	SO8 package information	20
5.6	TSSOP14 package information	21
5.7	SO14 package information	22
6	Ordering information	23
7	Revision history	24

1 Package pin connections

Figure 1. Pin connections for each package (top view)



1. The exposed pad of the DFN8 2x2 can be connected to VCC- or left floating.

2 Absolute maximum ratings and operating conditions

Table 2. Absolute maximum ratings (AMR)

Symbol	Parameter	Value	Unit
V_{CC}	Supply voltage ⁽¹⁾	6	V
V_{id}	Differential input voltage ⁽²⁾	$\pm V_{CC}$	
V_{in}	Input pins (IN+ and IN- pins) voltage ⁽³⁾	$V_{CC-} - 0.3$ to $V_{CC+} + 0.3$	
I_{in}	Input current ⁽⁴⁾	10	mA
T_{stg}	Storage temperature	-65 to +150	°C
R_{thja}	Thermal resistance junction to ambient ⁽⁵⁾⁽⁶⁾		°C/W
	SC70-5	205	
	SOT23-5	250	
	DFN8 2x2	57	
	MiniSO8	190	
	SO8	125	
	TSSOP14	100	
SO14	105		
T_j	Maximum junction temperature	150	°C
ESD	HBM: human body model ⁽⁷⁾	4000	V
	MM: machine model ⁽⁸⁾	250	
	CDM: charged device model ⁽⁹⁾	1300	
	Latch-up immunity	200	mA

1. All voltage values, except differential voltage, are with respect to network ground terminal.
2. Differential voltages are the non-inverting input terminal with respect to the inverting input terminal.
3. $V_{CC-} - V_{in}$ must not exceed 6 V, V_{in} must not exceed 6 V.
4. Input current must be limited by a resistor in series with the inputs.
5. Short-circuits can cause excessive heating and destructive dissipation.
6. R_{th} are typical values.
7. Human body model: 100 pF discharged through a 1.5 kΩ resistor between two pins of the device, done for all couples of pin combinations with other pins floating.
8. Machine model: a 200 pF cap is charged to the specified voltage, then discharged directly between two pins of the device with no external series resistor (internal resistor < 5 Ω), done for all couples of pin combinations with other pins floating.
9. Charged device model: all pins plus package are charged together to the specified voltage and then discharged directly to the ground.

Table 3. Operating conditions

Symbol	Parameter	Value	Unit
V_{CC}	Supply voltage	2.3 to 5.5	V
V_{icm}	Common mode input voltage range	$V_{CC-} - 0.2$ to $V_{CC+} - 1$	
T_{oper}	Operating free air temperature range	-40 to +125	°C

3 Electrical characteristics

Table 4. Electrical characteristics at $V_{CC+} = 2.7\text{ V}$ with $V_{CC-} = 0\text{ V}$, $V_{icm} = V_{CC}/2$, $T_{amb} = 25^\circ\text{ C}$, and R_L connected to $V_{CC}/2$ (unless otherwise specified)

Symbol	Parameter	Conditions	Min.	Typ.	Max.	Unit
DC performance						
V_{io}	Input offset voltage				4	mV
		$-40^\circ\text{ C} < T < 125^\circ\text{ C}$			6	
$\Delta V_{io}/\Delta T$	Input offset voltage drift ⁽¹⁾	$-40^\circ\text{ C} < T < 125^\circ\text{ C}$		1		$\mu\text{V}/^\circ\text{ C}$
I_{io}	Input offset current	$V_{out} = V_{CC}/2$		0.5	30	nA
		$-40^\circ\text{ C} < T < 125^\circ\text{ C}$			50	
I_{ib}	Input bias current	$V_{out} = V_{CC}/2$		27	60	nA
		$-40^\circ\text{ C} < T < 125^\circ\text{ C}$			110	
CMR	Common mode rejection ratio $20 \log (\Delta V_{icm}/\Delta V_{io})$	$V_{ic} = 0\text{ V to } V_{CC}-1\text{ V},$ $V_{out} = V_{CC}/2$	70	75		dB
		$-40^\circ\text{ C} < T < 125^\circ\text{ C}$	68			
A_{vd}	Large signal voltage gain	$R_L = 10\text{ k}\Omega,$ $V_{out} = 0.5\text{ V to } (V_{CC}-0.5\text{ V})$	100	110		dB
		$-40^\circ\text{ C} < T < 125^\circ\text{ C}$	90			
		$R_L = 2\text{ k}\Omega,$ $V_{out} = 0.5\text{ V to } (V_{CC}-0.5\text{ V})$	90	100		
		$-40^\circ\text{ C} < T < 125^\circ\text{ C}$	80			
$V_{CC}-V_{OH}$	High level output voltage	$R_L = 10\text{ k}\Omega,$		10	100	mV
		$-40^\circ\text{ C} < T < 125^\circ\text{ C}$			200	
		$R_L = 2\text{ k}\Omega$		40	300	
		$-40^\circ\text{ C} < T < 125^\circ\text{ C}$			400	
V_{OL}	Low level output voltage	$R_L = 10\text{ k}\Omega,$		65	180	mV
		$-40^\circ\text{ C} < T < 125^\circ\text{ C}$			280	
		$R_L = 2\text{ k}\Omega,$		120	300	
		$-40^\circ\text{ C} < T < 125^\circ\text{ C}$			400	
I_{out}	I_{sink}	$V_{out} = V_{CC}, V_{id} = -1\text{ V}$	15	26		mA
		$-40^\circ\text{ C} < T < 125^\circ\text{ C}$	15			
	I_{source}	$V_{out} = 0\text{ V}, V_{id} = 1\text{ V}$	15	21		
		$-40^\circ\text{ C} < T < 125^\circ\text{ C}$	12			
I_{CC}	Supply current (per channel)	No load, $V_{out} = V_{CC}/2$		120	180	μA
		$-40^\circ\text{ C} < T < 125^\circ\text{ C}$			180	

Table 4. Electrical characteristics at $V_{CC+} = 2.7\text{ V}$ with $V_{CC-} = 0\text{ V}$, $V_{ICM} = V_{CC}/2$, $T_{amb} = 25^\circ\text{ C}$, and R_L connected to $V_{CC}/2$ (unless otherwise specified) (continued)

Symbol	Parameter	Conditions	Min.	Typ.	Max.	Unit
AC performance						
GBP	Gain bandwidth product	$R_L > 1\text{ M}\Omega$ $C_L = 200\text{ pF}$		1.3		MHz
F_u	Unity gain frequency			1		
Φ_m	Phase margin			60		degrees
G_m	Gain margin			10		dB
SR	Slew rate	$R_L > 1\text{ M}\Omega$ $C_L = 200\text{ pF}$ $V_{out} = 0.5\text{ V to } V_{CC} - 0.5\text{ V}$		0.6		$\text{V}/\mu\text{s}$
e_n	Equivalent input noise voltage	$f = 1\text{ kHz}$ $f = 10\text{ kHz}$		31 20		$\frac{\text{nV}}{\sqrt{\text{Hz}}}$
i_n	Equivalent input noise current	$f = 1\text{ kHz}$		0.30		$\frac{\text{pA}}{\sqrt{\text{Hz}}}$
THD+N	Total harmonic distortion + noise	$f_{in} = 1\text{ kHz}$, $A_{CL} = 1$, $R_L = 10\text{ k}\Omega$, $V_{ICM} = V_{CC}/2$, $BW = 22\text{ kHz}$, $V_{out} = 1\text{ V}_{pp}$		0.002		%

Table 5. Electrical characteristics at $V_{CC+} = 5\text{ V}$ with $V_{CC-} = 0\text{ V}$, $V_{icm} = V_{CC}/2$, $T_{amb} = 25^\circ\text{ C}$, and R_L connected to $V_{CC}/2$ (unless otherwise specified)

Symbol	Parameter	Conditions	Min.	Typ.	Max.	Unit
DC performance						
V_{io}	Input offset voltage				4	mV
		$-40^\circ\text{ C} < T < 125^\circ\text{ C}$			6	
$\Delta V_{io}/\Delta T$	Input offset voltage drift ⁽¹⁾	$-40^\circ\text{ C} < T < 125^\circ\text{ C}$		1		$\mu\text{V}/^\circ\text{ C}$
I_{io}	Input offset current	$V_{out} = V_{CC}/2$		0.5	30	nA
		$-40^\circ\text{ C} < T < 125^\circ\text{ C}$			50	
I_{ib}	Input bias current	$V_{out} = V_{CC}/2$		27	60	
		$-40^\circ\text{ C} < T < 125^\circ\text{ C}$			110	
CMR	Common mode rejection ratio $20 \log (\Delta V_{icm}/\Delta V_{io})$	$V_{ic} = 0\text{ V to } V_{CC}-1\text{ V},$ $V_{out} = V_{CC}/2$	72	75		dB
		$-40^\circ\text{ C} < T < 125^\circ\text{ C}$	70			
SVR	Supply voltage rejection ratio $20 \log (\Delta V_{CC}/\Delta V_{io})$	$V_{CC} = 2.5\text{ to }5\text{ V}$	72	79		
		$-40^\circ\text{ C} < T < 125^\circ\text{ C}$	70			
A_{vd}	Large signal voltage gain	$R_L = 10\text{ k}\Omega,$ $V_{out} = 0.5\text{ V to } (V_{CC} - 0.5\text{ V})$	100	110		
		$-40^\circ\text{ C} < T < 125^\circ\text{ C}$	90			
		$R_L = 2\text{ k}\Omega,$	90	100		
		$-40^\circ\text{ C} < T < 125^\circ\text{ C}$	80			
$V_{CC}-V_{OH}$	High level output voltage	$R_L = 10\text{ k}\Omega$		10	100	mV
		$-40^\circ\text{ C} < T < 125^\circ\text{ C}$			200	
		$R_L = 2\text{ k}\Omega,$		40	300	
		$-40^\circ\text{ C} < T < 125^\circ\text{ C}$			400	
V_{OL}	Low level output voltage	$R_L = 10\text{ k}\Omega$		65	180	
		$-40^\circ\text{ C} < T < 125^\circ\text{ C}$			280	
		$R_L = 2\text{ k}\Omega$		120	300	
		$-40^\circ\text{ C} < T < 125^\circ\text{ C}$			400	
I_{out}	I_{sink}	$V_{out} = V_{CC}, V_{id} = -1\text{ V}$	35	43		mA
		$-40^\circ\text{ C} < T < 125^\circ\text{ C}$	25			
	I_{source}	$V_{out} = 0\text{ V}, V_{id} = 1\text{ V}$	60	70		
		$-40^\circ\text{ C} < T < 125^\circ\text{ C}$	50			
I_{CC}	Supply current (per channel)	No load, $V_{out} = V_{CC}/2$		130	180	$\mu\text{ A}$
		$-40^\circ\text{ C} < T < 125^\circ\text{ C}$			180	

Table 5. Electrical characteristics at $V_{CC+} = 5\text{ V}$ with $V_{CC-} = 0\text{ V}$, $V_{icm} = V_{CC}/2$, $T_{amb} = 25^\circ\text{ C}$, and R_L connected to $V_{CC}/2$ (unless otherwise specified) (continued)

Symbol	Parameter	Conditions	Min.	Typ.	Max.	Unit
AC performance						
GBP	Gain bandwidth product	$R_L > 1\text{ M}\Omega$, $C_L = 200\text{ pF}$		1.3		MHz
F_u	Unity gain frequency			1		
Φ_m	Phase margin			60		degrees
G_m	Gain margin			10		dB
SR	Slew rate	$R_L > 1\text{ M}\Omega$, $C_L = 200\text{ pF}$ $V_{out} = 0.5\text{ V to } V_{CC} - 0.5\text{V}$		0.7		V/ μs
e_n	Equivalent input noise voltage	$f = 1\text{ kHz}$ $f = 10\text{ kHz}$		30 20		$\frac{\text{nV}}{\sqrt{\text{Hz}}}$
i_n	Equivalent input noise current	$f = 1\text{ kHz}$		0.30		$\frac{\text{pA}}{\sqrt{\text{Hz}}}$
THD+N	Total harmonic distortion + noise	$f_{in} = 1\text{ kHz}$, $A_{CL} = 1$, $R_L = 10\text{ k}\Omega$, $V_{ICM} = V_{CC}/2$, $BW = 22\text{ kHz}$, $V_{out} = 1\text{ Vpp}$		0.002		%

1. See [Section 4.4: Input offset voltage drift over temperature](#).

Figure 2. Supply current vs. supply voltage at $V_{icm} = V_{CC}/2$



Figure 3. Vio distribution at $V_{CC} = 5 V$



Figure 4. Input offset voltage vs. input common mode voltage at $V_{CC} = 5 V$



Figure 5. Output current vs. output voltage at $V_{CC} = 2.7 V$



Figure 6. Output current vs. output voltage at $V_{CC} = 5 V$

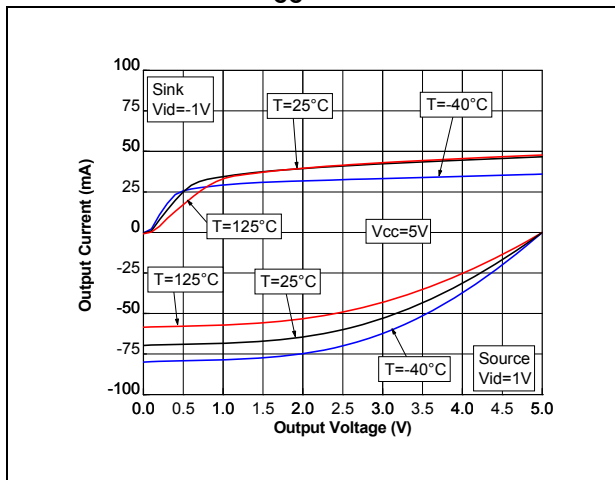

Figure 7. Output current vs. supply voltage at $V_{icm} = V_{CC}/2$

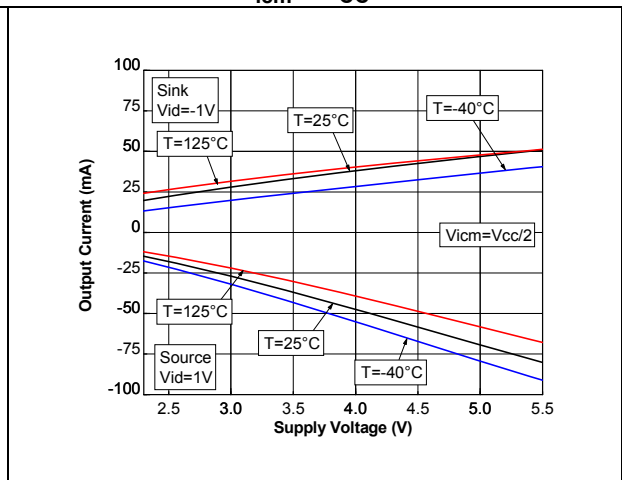

Figure 8. Voltage gain and phase with $C_I = 100 \text{ pF}$

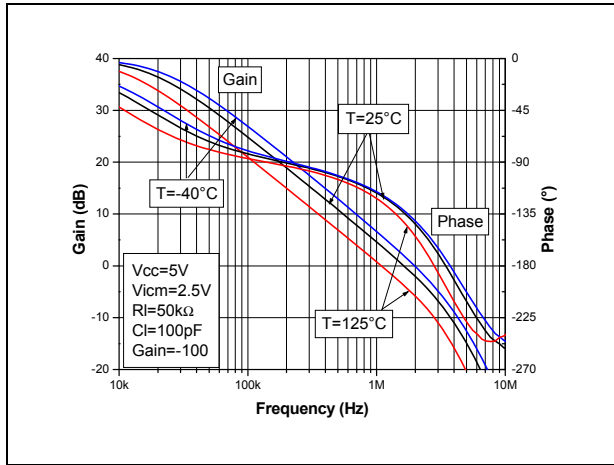

Figure 9. Voltage gain and phase with $C_I = 200 \text{ pF}$

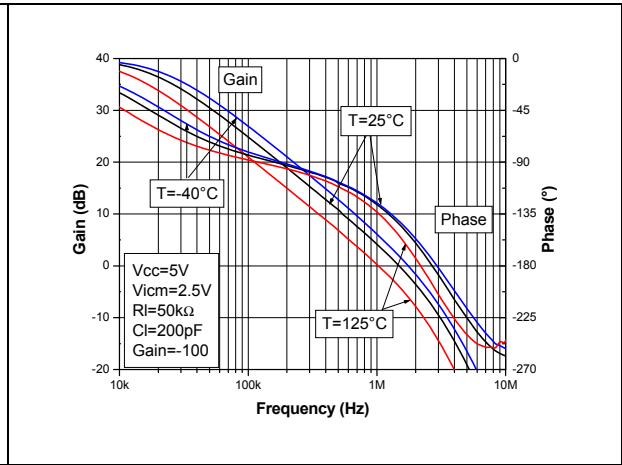

Figure 10. Gain margin vs. load capacitor at $V_{CC} = 5 \text{ V}$

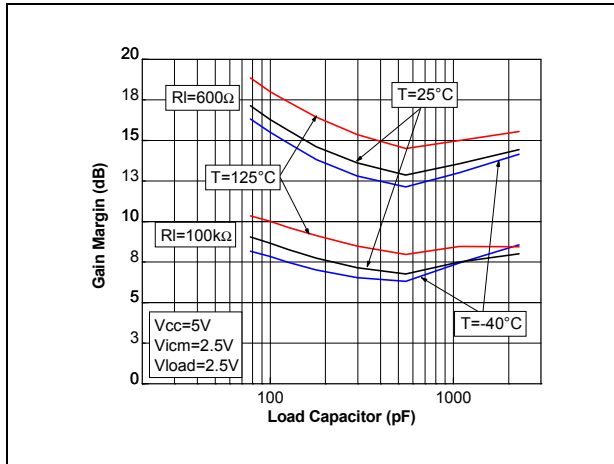

Figure 11. Phase margin vs. load capacitor at $V_{CC} = 5 \text{ V}$

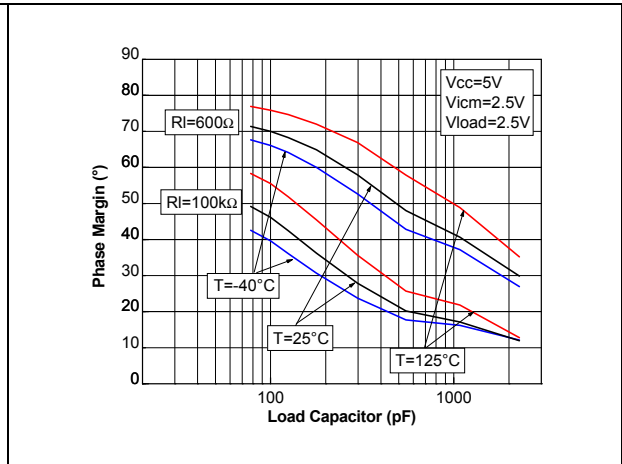

Figure 12. Closed-loop gain in voltage follower configuration for different capacitive loads

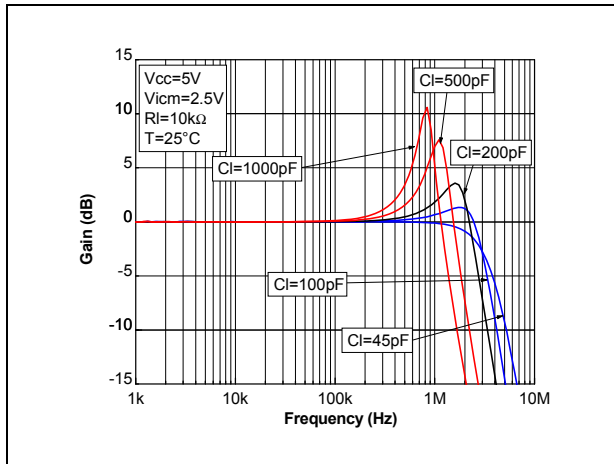

Figure 13. Phase margin vs. output current at $V_{CC} = 5 \text{ V}$

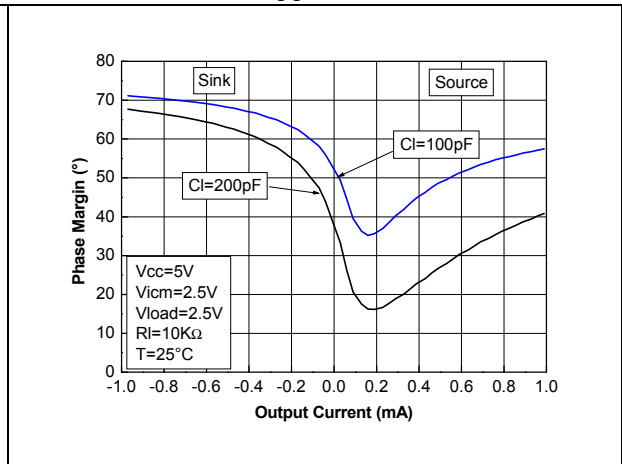

Figure 14. Positive and negative slew rate vs. supply voltage



Figure 15. Positive slew rate at V_{CC} = 5 V with CI = 100 pF



Figure 16. Negative slew rate at V_{CC} = 5 V with CI = 100 pF



Figure 17. Noise vs. frequency



Figure 18. 0.1 Hz to 10 Hz noise at V_{CC} = 5 V

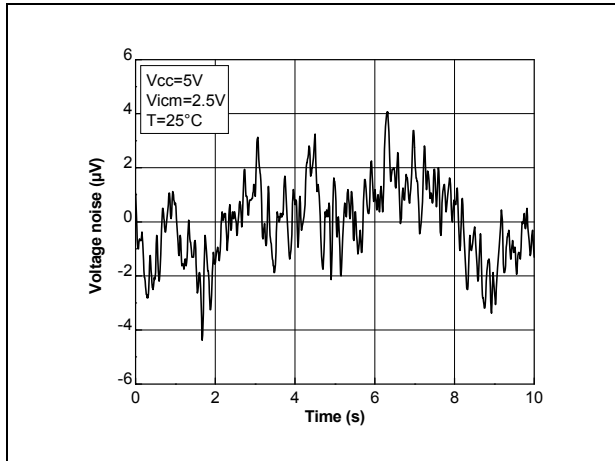

Figure 19. Distortion + noise vs. frequency

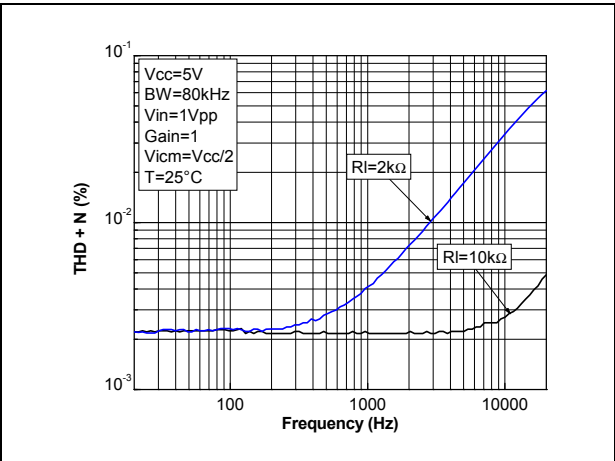

Figure 20. Distortion + noise vs. output voltage



4 Application information

4.1 Operating voltages

The LMX321, LMX358, and LMX324 can operate from 2.3 V to 5.5 V. The devices' parameters are fully specified for 2.7 V and 5 V power supplies. Additionally, the main specifications are guaranteed in extended temperature ranges from -40° C to +125° C.

4.2 Input common-mode range

The LMX321, LMX358, and LMX324 have an input common-mode range that includes ground. The input common-mode range is extended from $V_{CC-} - 0.2$ V to $V_{CC+} - 1$ V, with no output phase reversal.

4.3 Rail-to-rail output

The operational amplifiers' output levels can go close to the rails: to a maximum of 180 mV above and below the rail when connected to a 10 k Ω resistive load to $V_{CC}/2$.

4.4 Input offset voltage drift over temperature

The maximum input voltage drift over the temperature variation is defined in [Equation 1](#).

Equation 1

$$\frac{\Delta V_{io}}{\Delta T} = \max \left| \frac{V_{io}(T) - V_{io}(25^\circ \text{C})}{T - 25^\circ \text{C}} \right|$$

for $T_{\min} < T < T_{\max}$.

4.5 PCB layouts

For correct operation, it is advised to add 10 nF decoupling capacitors as close as possible to the power supply pins.

4.6 Macromodel

Accurate macromodels of the LMX321, LMX358, and LMX324 are available on STMicroelectronics' web site at www.st.com. These models are a trade-off between accuracy and complexity (that is, time simulation) of the LMX321, LMX358, and LMX324 operational amplifiers. They emulate the nominal performances of a typical device within the specified operating conditions mentioned in the datasheet. They also help to validate a design approach and to select the right operational amplifier, *but they do not replace on-board measurements*.

5 Package information

In order to meet environmental requirements, ST offers these devices in different grades of ECOPACK[®] packages, depending on their level of environmental compliance. ECOPACK[®] specifications, grade definitions and product status are available at: www.st.com. ECOPACK[®] is an ST trademark.

5.1 SC70-5 (or SOT323-5) package information

Figure 21. SC70-5 (or SOT323-5) package mechanical drawing

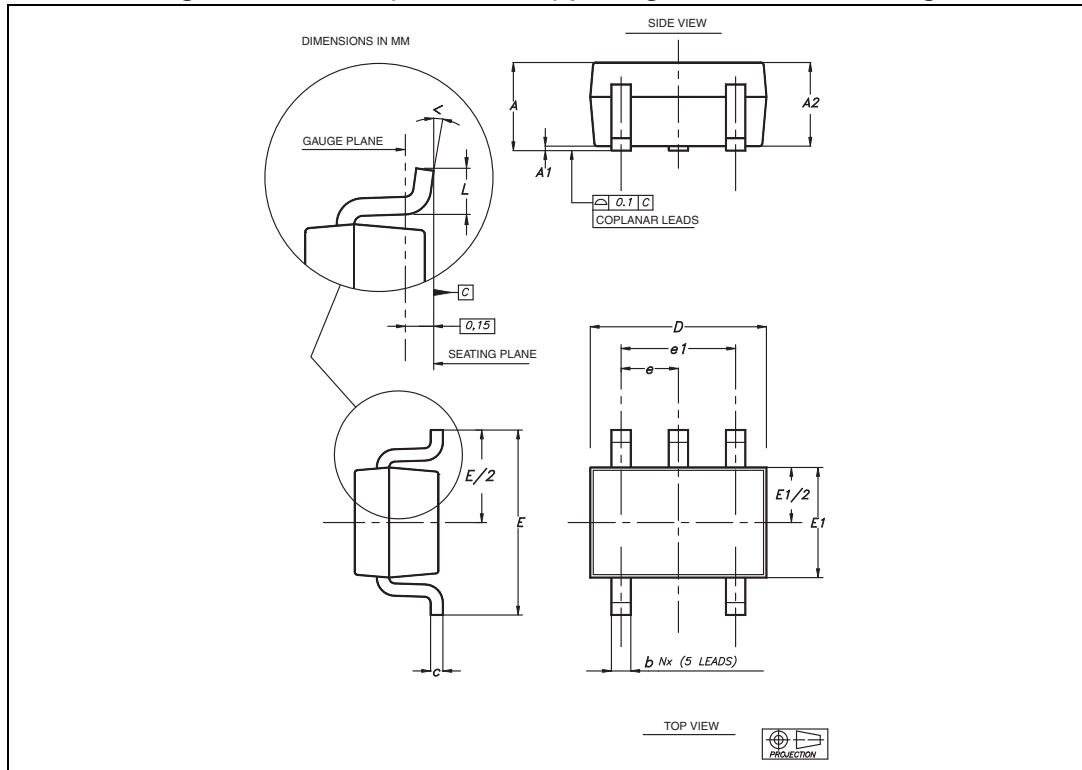

Table 6. SC70-5 (or SOT323-5) package mechanical data

Ref	Dimensions					
	Millimeters			Inches		
	Min	Typ	Max	Min	Typ	Max
A	0.80		1.10	0.032		0.043
A1			0.10			0.004
A2	0.80	0.90	1.00	0.032	0.035	0.039
b	0.15		0.30	0.006		0.012
c	0.10		0.22	0.004		0.009
D	1.80	2.00	2.20	0.071	0.079	0.087
E	1.80	2.10	2.40	0.071	0.083	0.094
E1	1.15	1.25	1.35	0.045	0.049	0.053
e		0.65			0.025	
e1		1.30			0.051	
L	0.26	0.36	0.46	0.010	0.014	0.018
<	0 °		8 °	0 °		8 °

5.2 SOT23-5 package information

Figure 22. SOT23-5 package mechanical drawing



Table 7. SOT23-5 package mechanical data

Ref.	Dimensions					
	Millimeters			Inches		
	Min.	Typ.	Max.	Min.	Typ.	Max.
A	0.90	1.20	1.45	0.035	0.047	0.057
A1			0.15			0.006
A2	0.90	1.05	1.30	0.035	0.041	0.051
B	0.35	0.40	0.50	0.013	0.015	0.019
C	0.09	0.15	0.20	0.003	0.006	0.008
D	2.80	2.90	3.00	0.110	0.114	0.118
D1		1.90			0.075	
e		0.95			0.037	
E	2.60	2.80	3.00	0.102	0.110	0.118
F	1.50	1.60	1.75	0.059	0.063	0.069
L	0.10	0.35	0.60	0.004	0.013	0.023
K	0 °		10 °	0 °		10 °

5.3 DFN8 2x2 package information

Figure 23. DFN8 2x2 package mechanical drawing

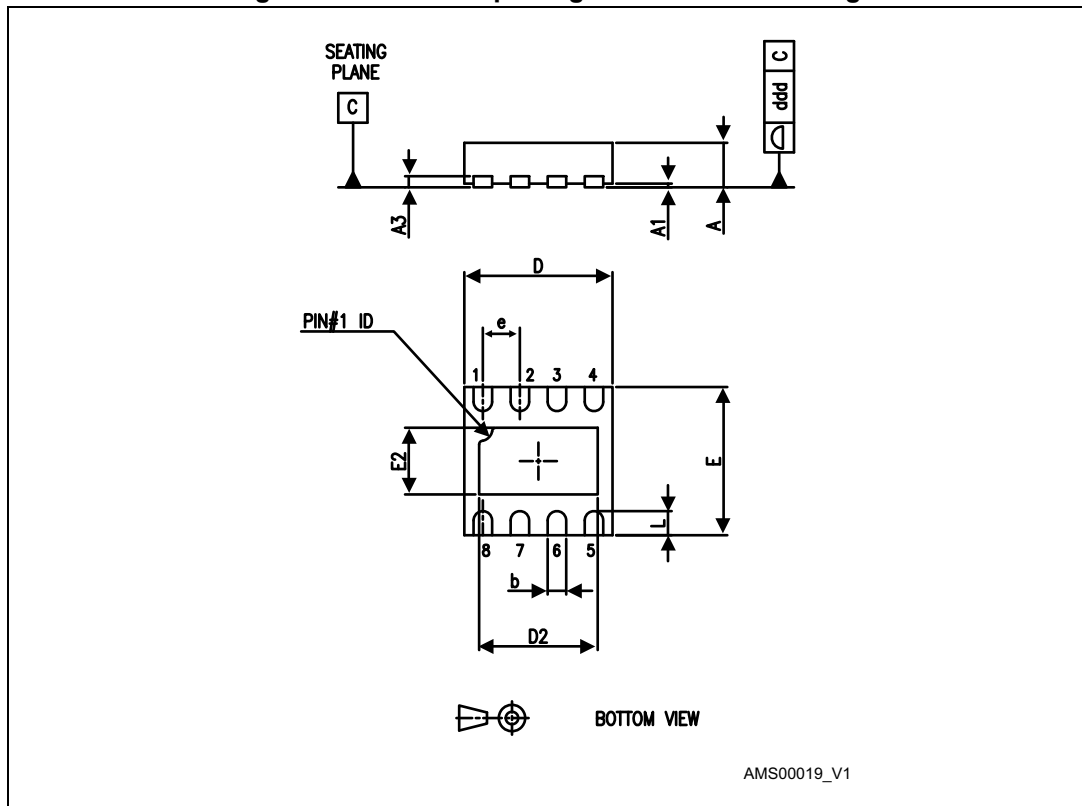

Figure 24. DFN8 2x2x0.6 mm package mechanical data (pitch 0.5 mm)

Ref.	Dimensions					
	Millimeters			Inches		
	Min.	Typ.	Max.	Min.	Typ.	Max.
A	0.51	0.55	0.60	0.020	0.022	0.024
A1			0.05			0.002
A3		0.15			0.006	
b	0.18	0.25	0.30	0.007	0.010	0.012
D	1.85	2.00	2.15	0.073	0.079	0.085
D2	1.45	1.60	1.70	0.057	0.063	0.067
E	1.85	2.00	2.15	0.073	0.079	0.085
E2	0.75	0.90	1.00	0.030	0.035	0.039
e		0.50			0.020	
L			0.425			0.017
ddd			0.08			0.003

Figure 25. DFN8 2x2 footprint recommendation



5.4 MiniSO8 package information

Figure 26. MiniSO8 package mechanical drawing

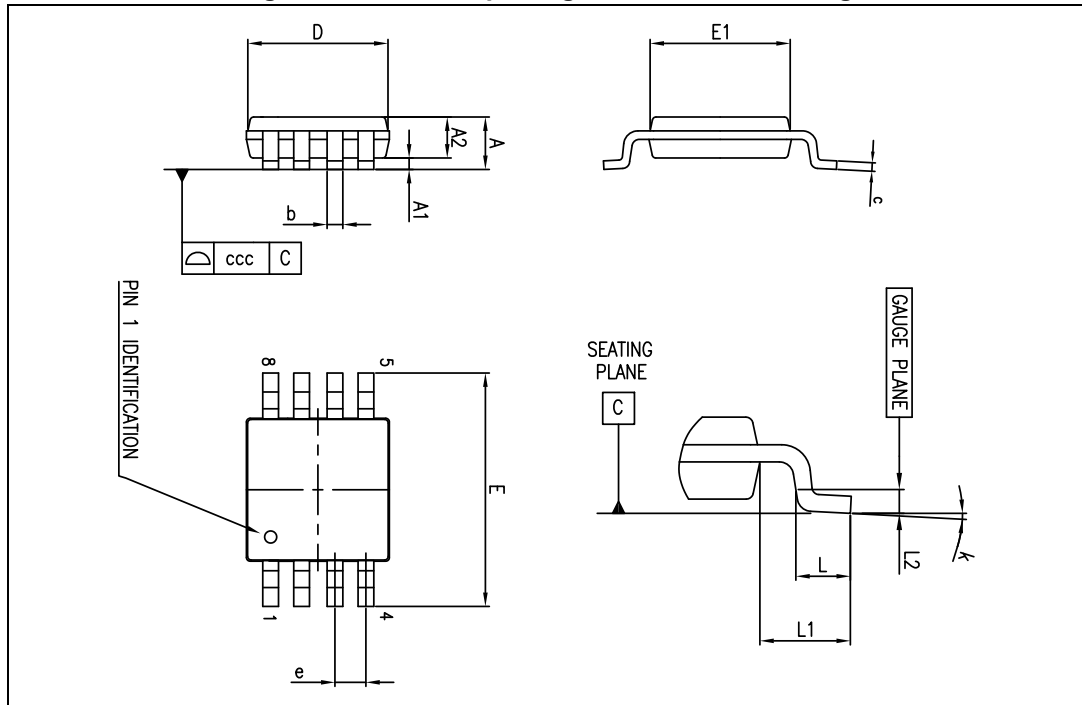

Table 8. MiniSO8 package mechanical data

Ref.	Dimensions					
	Millimeters			Inches		
	Min.	Typ.	Max.	Min.	Typ.	Max.
A			1.1			0.043
A1	0		0.15	0		0.006
A2	0.75	0.85	0.95	0.030	0.033	0.037
b	0.22		0.40	0.009		0.016
c	0.08		0.23	0.003		0.009
D	2.80	3.00	3.20	0.11	0.118	0.126
E	4.65	4.90	5.15	0.183	0.193	0.203
E1	2.80	3.00	3.10	0.11	0.118	0.122
e		0.65			0.026	
L	0.40	0.60	0.80	0.016	0.024	0.031
L1		0.95			0.037	
L2		0.25			0.010	
k	0°		8°	0°		8°
ccc			0.10			0.004

5.5 SO8 package information

Figure 27. SO8 package mechanical drawing



Table 9. SO8 package mechanical data

Ref.	Dimensions					
	Millimeters			Inches		
	Min.	Typ.	Max.	Min.	Typ.	Max.
A			1.75			0.069
A1	0.10		0.25	0.004		0.010
A2	1.25			0.049		
b	0.28		0.48	0.011		0.019
c	0.17		0.23	0.007		0.010
D	4.80	4.90	5.00	0.189	0.193	0.197
E	5.80	6.00	6.20	0.228	0.236	0.244
E1	3.80	3.90	4.00	0.150	0.154	0.157
e		1.27			0.050	
h	0.25		0.50	0.010		0.020
L	0.40		1.27	0.016		0.050
L1		1.04			0.040	
k	1°		8°	1°		8°
ccc			0.10			0.004

5.6 TSSOP14 package information

Figure 28. TSSOP14 package mechanical drawing



Table 10. TSSOP14 package mechanical data

Ref.	Dimensions					
	Millimeters			Inches		
	Min.	Typ.	Max.	Min.	Typ.	Max.
A			1.20			0.047
A1	0.05		0.15	0.002	0.004	0.006
A2	0.80	1.00	1.05	0.031	0.039	0.041
b	0.19		0.30	0.007		0.012
c	0.09		0.20	0.004		0.0089
D	4.90	5.00	5.10	0.193	0.197	0.201
E	6.20	6.40	6.60	0.244	0.252	0.260
E1	4.30	4.40	4.50	0.169	0.173	0.176
e		0.65			0.0256	
L	0.45	0.60	0.75	0.018	0.024	0.030
L1		1.00			0.039	
k	0 °		8 °	0 °		8 °
aaa			0.10			0.004

5.7 SO14 package information

Figure 29. SO14 package mechanical drawing

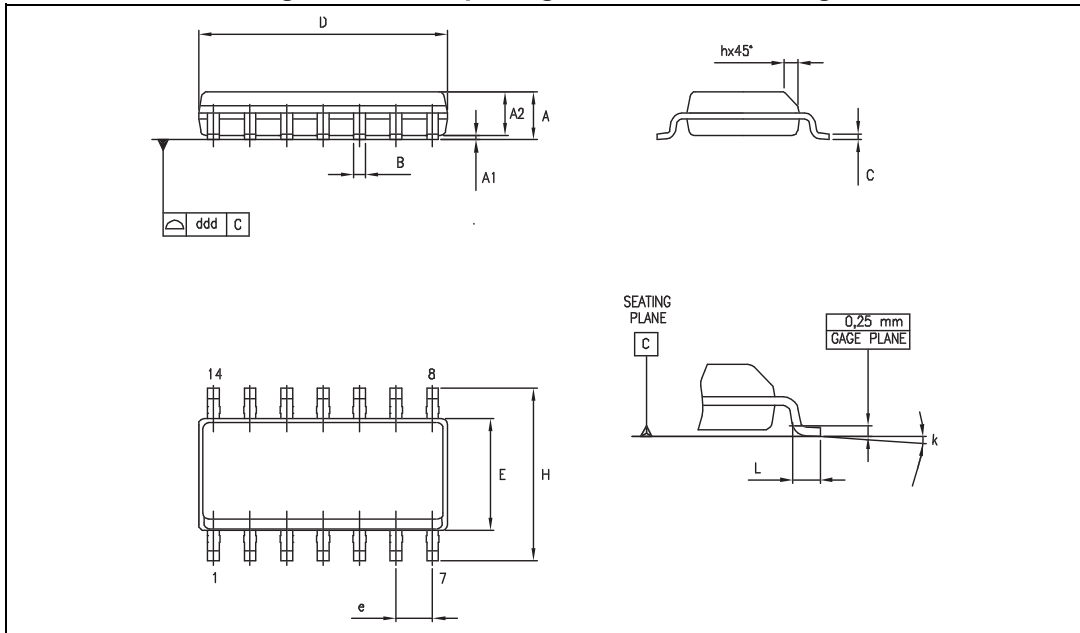

Table 11. SO14 package mechanical data

Dimensions						
Ref.	Millimeters			Inches		
	Min.	Typ.	Max.	Min.	Typ.	Max.
A	1.35		1.75	0.05		0.068
A1	0.10		0.25	0.004		0.009
A2	1.10		1.65	0.04		0.06
B	0.33		0.51	0.01		0.02
C	0.19		0.25	0.007		0.009
D	8.55		8.75	0.33		0.34
E	3.80		4.0	0.15		0.15
e		1.27			0.05	
H	5.80		6.20	0.22		0.24
h	0.25		0.50	0.009		0.02
L	0.40		1.27	0.015		0.05
k	8° (max.)					
ddd			0.10			0.004

6 Ordering information

Table 12. Order codes

Order code	Temperature range	Package	Packing	Marking
LMX321ICT	-40° C to +125° C	SC70-5	Tape and reel	K21
LMX321ILT		SOT23-5		K430
LMX358IQ2T		DFN8 2x2		K21
LMX358IST		MiniSO8		K430
LMX358IDT		SO8		LMX358I
LMX324IPT		TSSOP14		LMX324I
LMX324IDT		SO14		LMX324I

7 Revision history

Table 13. Document revision history

Date	Revision	Changes
19-Mar-2012	1	Initial release.
06-Apr-2012	2	Document status promoted from Target Specification to Production Data.
07-May-2013	3	Added DFN8 2x2 silhouette, pinout, and package Table 2: Absolute maximum ratings (AMR) : added R_{thja} data for DFN8 2x2 package. Table 12: Order codes : added LMX358IQ2T order code.

Please Read Carefully:

Information in this document is provided solely in connection with ST products. STMicroelectronics NV and its subsidiaries ("ST") reserve the right to make changes, corrections, modifications or improvements, to this document, and the products and services described herein at any time, without notice.

All ST products are sold pursuant to ST's terms and conditions of sale.

Purchasers are solely responsible for the choice, selection and use of the ST products and services described herein, and ST assumes no liability whatsoever relating to the choice, selection or use of the ST products and services described herein.

No license, express or implied, by estoppel or otherwise, to any intellectual property rights is granted under this document. If any part of this document refers to any third party products or services it shall not be deemed a license grant by ST for the use of such third party products or services, or any intellectual property contained therein or considered as a warranty covering the use in any manner whatsoever of such third party products or services or any intellectual property contained therein.

UNLESS OTHERWISE SET FORTH IN ST'S TERMS AND CONDITIONS OF SALE ST DISCLAIMS ANY EXPRESS OR IMPLIED WARRANTY WITH RESPECT TO THE USE AND/OR SALE OF ST PRODUCTS INCLUDING WITHOUT LIMITATION IMPLIED WARRANTIES OF MERCHANTABILITY, FITNESS FOR A PARTICULAR PURPOSE (AND THEIR EQUIVALENTS UNDER THE LAWS OF ANY JURISDICTION), OR INFRINGEMENT OF ANY PATENT, COPYRIGHT OR OTHER INTELLECTUAL PROPERTY RIGHT.

ST PRODUCTS ARE NOT AUTHORIZED FOR USE IN WEAPONS. NOR ARE ST PRODUCTS DESIGNED OR AUTHORIZED FOR USE IN: (A) SAFETY CRITICAL APPLICATIONS SUCH AS LIFE SUPPORTING, ACTIVE IMPLANTED DEVICES OR SYSTEMS WITH PRODUCT FUNCTIONAL SAFETY REQUIREMENTS; (B) AERONAUTIC APPLICATIONS; (C) AUTOMOTIVE APPLICATIONS OR ENVIRONMENTS, AND/OR (D) AEROSPACE APPLICATIONS OR ENVIRONMENTS. WHERE ST PRODUCTS ARE NOT DESIGNED FOR SUCH USE, THE PURCHASER SHALL USE PRODUCTS AT PURCHASER'S SOLE RISK, EVEN IF ST HAS BEEN INFORMED IN WRITING OF SUCH USAGE, UNLESS A PRODUCT IS EXPRESSLY DESIGNATED BY ST AS BEING INTENDED FOR "AUTOMOTIVE, AUTOMOTIVE SAFETY OR MEDICAL" INDUSTRY DOMAINS ACCORDING TO ST PRODUCT DESIGN SPECIFICATIONS. PRODUCTS FORMALLY ESCC, QML OR JAN QUALIFIED ARE DEEMED SUITABLE FOR USE IN AEROSPACE BY THE CORRESPONDING GOVERNMENTAL AGENCY.

Resale of ST products with provisions different from the statements and/or technical features set forth in this document shall immediately void any warranty granted by ST for the ST product or service described herein and shall not create or extend in any manner whatsoever, any liability of ST.

ST and the ST logo are trademarks or registered trademarks of ST in various countries.

Information in this document supersedes and replaces all information previously supplied.

The ST logo is a registered trademark of STMicroelectronics. All other names are the property of their respective owners.

© 2013 STMicroelectronics - All rights reserved

STMicroelectronics group of companies

Australia - Belgium - Brazil - Canada - China - Czech Republic - Finland - France - Germany - Hong Kong - India - Israel - Italy - Japan - Malaysia - Malta - Morocco - Philippines - Singapore - Spain - Sweden - Switzerland - United Kingdom - United States of America

www.st.com





Компания «ЭлектроПласт» предлагает заключение долгосрочных отношений при поставках импортных электронных компонентов на взаимовыгодных условиях!

Наши преимущества:

- Оперативные поставки широкого спектра электронных компонентов отечественного и импортного производства напрямую от производителей и с крупнейших мировых складов;
- Поставка более 17-ти миллионов наименований электронных компонентов;
- Поставка сложных, дефицитных, либо снятых с производства позиций;
- Оперативные сроки поставки под заказ (от 5 рабочих дней);
- Экспресс доставка в любую точку России;
- Техническая поддержка проекта, помощь в подборе аналогов, поставка прототипов;
- Система менеджмента качества сертифицирована по Международному стандарту ISO 9001;
- Лицензия ФСБ на осуществление работ с использованием сведений, составляющих государственную тайну;
- Поставка специализированных компонентов (Xilinx, Altera, Analog Devices, Intersil, Interpoint, Microsemi, Aeroflex, Peregrine, Syfer, Eurofarad, Texas Instrument, Miteq, Cobham, E2V, MA-COM, Hittite, Mini-Circuits, General Dynamics и др.);

Помимо этого, одним из направлений компании «ЭлектроПласт» является направление «Источники питания». Мы предлагаем Вам помощь Конструкторского отдела:

- Подбор оптимального решения, техническое обоснование при выборе компонента;
- Подбор аналогов;
- Консультации по применению компонента;
- Поставка образцов и прототипов;
- Техническая поддержка проекта;
- Защита от снятия компонента с производства.



Как с нами связаться

Телефон: 8 (812) 309 58 32 (многоканальный)

Факс: 8 (812) 320-02-42

Электронная почта: org@eplast1.ru

Адрес: 198099, г. Санкт-Петербург, ул. Калинина, дом 2, корпус 4, литера А.