

# D2MV

## Miniature Basic Switch

### Highly reliable Miniature Basic Switch in spite of its Ultra-low Load action

- Twin crossbar contact employed for exceptionally high contact reliability.
- Unique internal mechanism that ensures high contact reliability even in micro load operations. Applicable for detection of light objects.

RoHS Compliant

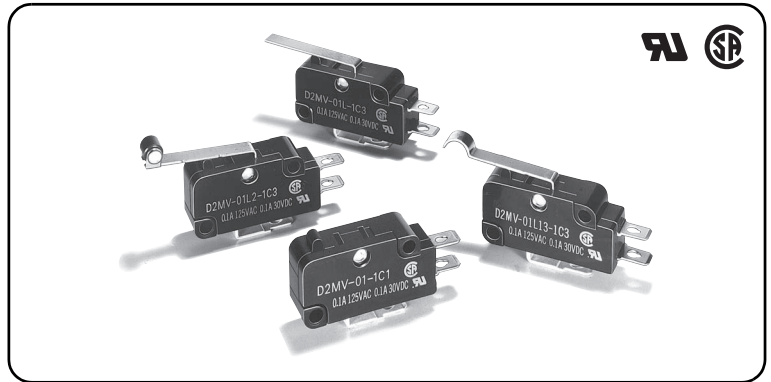

D  
2  
M  
V

### Model Number Legend

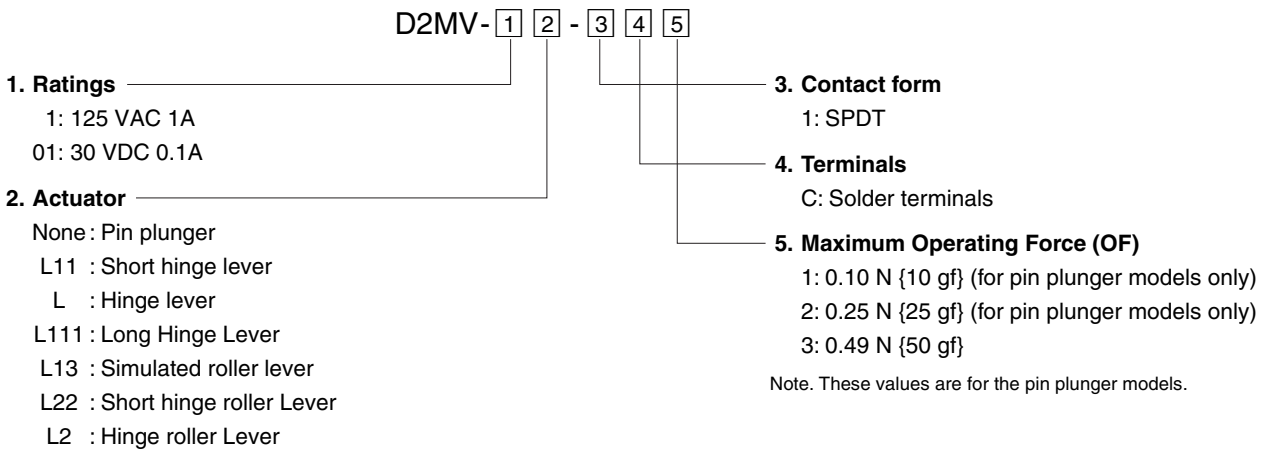

### List of Models

Actuator	Max. Operating Force (OF)	Ratings	
		1A	0.1A
Pin plunger	0.10 N {10 gf}	D2MV-1-1C1	D2MV-01-1C1
	0.25 N {25 gf}	D2MV-1-1C2	D2MV-01-1C2
	0.49 N {50 gf}	D2MV-1-1C3	D2MV-01-1C3
Short hinge lever	0.49 N {50 gf}	D2MV-1L11-1C3	D2MV-01L11-1C3
Hinge lever	0.29 N {30 gf}	D2MV-1L-1C3	D2MV-01L-1C3
Long hinge lever	0.15 N {15 gf}	D2MV-1L111-1C3	D2MV-01L111-1C3
Simulated roller lever	0.29 N {30 gf}	D2MV-1L13-1C3	D2MV-01L13-1C3
Short hinge roller lever	0.49 N {50 gf}	D2MV-1L22-1C3	D2MV-01L22-1C3
Hinge roller lever	0.29 N {30 gf}	D2MV-1L2-1C3	D2MV-01L2-1C3

### Contact Form

- SPDT

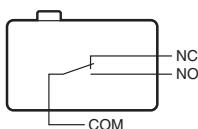

Separator (Sold Separately), Actuator (Sold Separately), Terminal Connector (Sold Separately) ➔ Refer to "Basic Switch Common Accessories"

## Contact Specifications

Item	Model	D2MV-1 models	D2MV-01 models
Contact	Specification	Needle	Twin crossbar
	Material	Silver	Gold alloy
	Gap (standard value)	0.5 mm	
Inrush current	NC	-	
	NO		
Minimum applicable load (reference value) *		5 VDC 30mA	5 VDC 1mA

\* Please refer to "●Using Micro Loads" in "Precautions" for more information on the minimum applicable load.

## Ratings

Rated voltage	Model	D2MV-1 models	D2MV-01 models
	Item	Resistive load	
125 VAC		1A	0.1A
30 VDC		1A	0.1A

Note. The above rating values apply under the following test conditions.  
 (1) Ambient temperature: 20±2°C  
 (2) Ambient humidity: 65±5%  
 (3) Operating frequency: 30 operations/min

## Approved Safety Standard

UL (UL1054) /CSA (CSA C22.2 No.55)

Rated voltage	Model	D2MV-1	D2MV-01
125 VAC		1A	0.1A
30 VDC		1A	0.1A

## Characteristics

Item	Model	D2MV-1 models	D2MV-01 models
Permissible operating speed		1 mm to 1 m/s (for pin plunger models)	
Permissible operating frequency	Mechanical	300 operations/min (for pin plunger models)	
	Electrical	60 operations/min	
Insulation resistance		100MΩ min. (at 500 VDC with insulation tester)	
Contact resistance (initial value)		30 mΩ max.	50 mΩ max.
Dielectric strength * 1	Between terminals of the same polarity	1,000 VAC 50/60 Hz 1min	
	Between current-carrying metal parts and ground	1,500 VAC 50/60 Hz 1min	
	Between each terminal and non-current-carrying metal parts	1,500 VAC 50/60 Hz 1min	
Vibration resistance * 2	Malfunction	10 to 55 Hz, 1.5 mm double amplitude	
Shock resistance	Durability	Models with OF of 0.10N	150 m/s <sup>2</sup> (approx. 15G) max.
		Models with OF between 0.25 to 0.49N	400 m/s <sup>2</sup> (approx. 40G) max.
	Malfunction * 2	100 m/s <sup>2</sup> (approx. 10G) max.	
Durability * 3	Mechanical	10,000,000 operations min. (60 operations/min)	
	Electrical	500,000 operations min. (30 operations/min)	1,000,000 operations min. (30 operations/min)
Degree of protection		IEC IP40	
Ambient operating temperature		-25°C to +80°C (at ambient humidity of 60% max.) (with no icing or condensation)	
Ambient operating humidity		85% max. (for +5°C to +35°C)	
Weight		Approx. 6g (pin plunger models)	

Note. The data given above are initial values.

- \*1. The values for dielectric strength shown are for models with a Separator (refer to "Micro Switch Common Accessories").
- \*2. The values are at Free Position and Total Travel Position values for pin plunger, and Total Travel Position value for lever. Close or open circuit of the contact is 1ms max.

## Terminals/Apearances (Unit:mm)

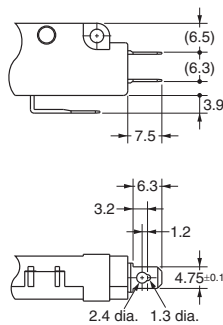

## Mounting Holes (Unit: mm)

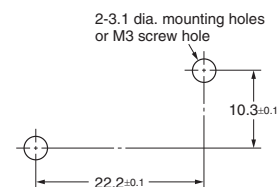

## Dimensions (Unit: mm)/Operating Characteristics

### ●Pin plunger Models

D2MV-1-1C□

D2MV-01-1C□

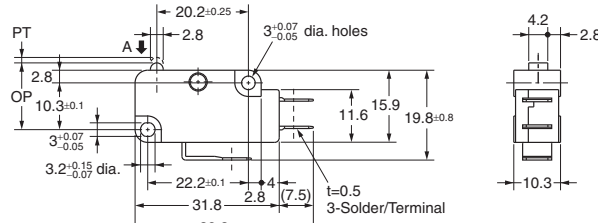
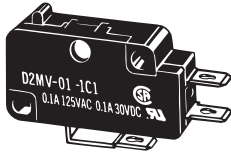

Operating characteristics		Model	D2MV-1-1C1 D2MV-01-1C1	D2MV-1-1C2 D2MV-01-1C2	D2MV-1-1C3 D2MV-01-1C3
Operating Force	OF Max.		0.10N {10 gf}	0.25N {25 gf}	0.49N {50 gf}
Releasing Force	RF Min.		0.005N {0.5 gf}	0.01N {1 gf}	0.02N {2 gf}
Pretravel	PT Max.			1.2 mm	
Overtravel	OT Min.			1.3 mm	
Movement Differential	MD Max.			0.25 mm	
Operating Position	OP		14.7±0.4 mm		

Note. The □ in the model number is for the OF code.

### ●Short Hinge Lever Models

D2MV-1L11-1C3

D2MV-01L11-1C3

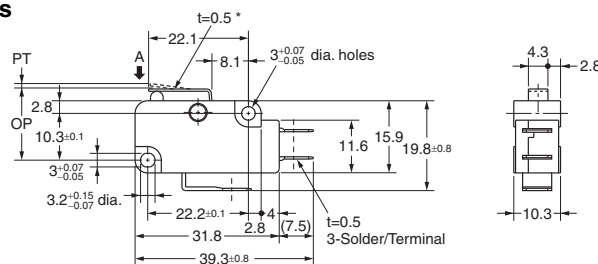
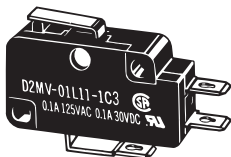

\* Stainless-steel lever

Operating characteristics		Model	D2MV-1L11-1C3 D2MV-01L11-1C3
Operating Force	OF Max.		0.49N {50 gf}
Releasing Force	RF Min.		0.04N {4 gf} (reference value)
Pretravel	PT Max.		1.7 mm
Overtravel	OT Min.		1.0 mm
Movement Differential	MD Max.		0.4 mm
Operating Position	OP		15.2±0.5 mm

Note. The indicated reference values of RF are for cases where the lever weight is not applied to the plunger.

### ●Hinge Lever Models

D2MV-1L-1C3

D2MV-01L-1C3

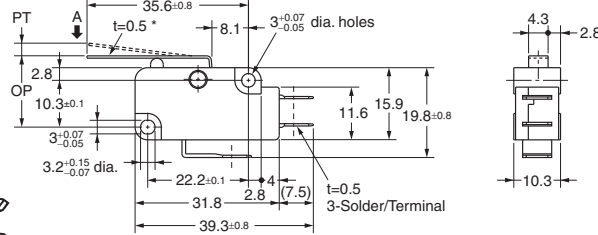

\* Stainless-steel lever

Operating characteristics		Model	D2MV-1L-1C3 D2MV-01L-1C3
Operating Force	OF Max.		0.29N {30 gf}
Releasing Force	RF Min.		0.02N {2 gf} (reference value)
Pretravel	PT Max.		3.3 mm
Overtravel	OT Min.		2.1 mm
Movement Differential	MD Max.		0.7 mm
Operating Position	OP		15.2±1.2 mm

Note. The indicated reference values of RF are for cases where the lever weight is not applied to the plunger.

### ●Long Hinge Lever Models

D2MV-1L111-1C3

D2MV-01L111-1C3

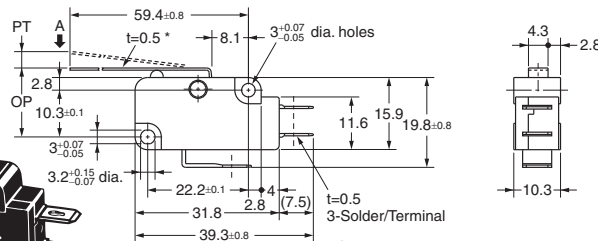
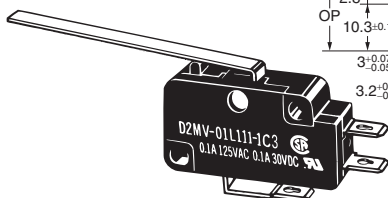

\* Stainless-steel lever

Operating characteristics		Model	D2MV-1L111-1C3 D2MV-01L111-1C3
Operating Force	OF Max.		0.15N {15 gf}
Releasing Force	RF Min.		0.01N {1 gf} (reference value)
Pretravel	PT Max.		6.0 mm
Overtravel	OT Min.		4.0 mm
Movement Differential	MD Max.		1.4 mm
Operating Position	OP		15.2±2.6 mm

Note. The indicated reference values of RF are for cases where the lever weight is not applied to the plunger.

### ●Simulated Roller Lever Models

D2MV-1L13-1C3

D2MV-01L13-1C3

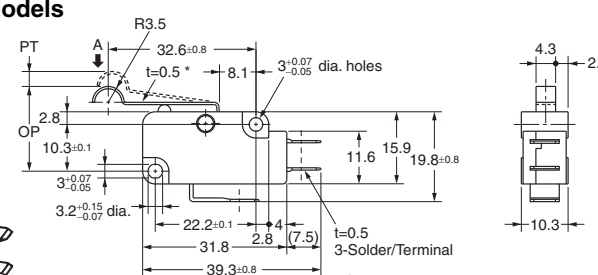
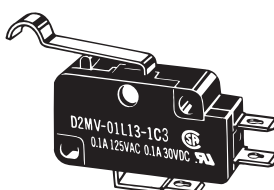

\* Stainless-steel lever

Operating characteristics		Model	D2MV-1L13-1C3 D2MV-01L13-1C3
Operating Force	OF Max.		0.29N {30 gf}
Releasing Force	RF Min.		0.02N {2 gf} (reference value)
Pretravel	PT Max.		3.3 mm
Overtravel	OT Min.		1.9 mm
Movement Differential	MD Max.		0.7 mm
Operating Position	OP		18.7±1.2 mm

Note. The indicated reference values of RF are for cases where the lever weight is not applied to the plunger.

Note 1. Unless otherwise specified, a tolerance of ±0.4 mm applies to all dimensions.

Note 2. The operating characteristics are for operation in the A direction (↓).

## ●Short Hinge Roller Lever Models

D2MV-1L22-1C3  
D2MV-01L22-1C3

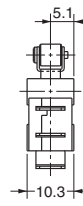
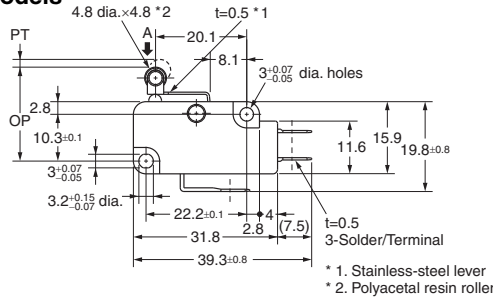
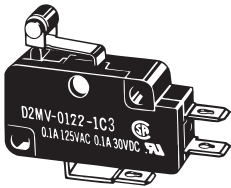

Operating characteristics	Model	
	D2MV-1L22-1C3	D2MV-01L22-1C3
Operating Force	OF Max.	0.49N (50 gf)
Releasing Force	RF Min.	0.04N (4 gf) (reference value)
Pretravel	PT Max.	1.7 mm
Overtravel	OT Min.	1.0 mm
Movement Differential	MD Max.	0.4 mm
Operating Position	OP	20.7±0.6 mm

Note. The indicated reference values of RF are for cases where the lever weight is not applied to the plunger.

## ●Hinge Roller Lever Models

D2MV-1L2-1C3  
D2MV-01L2-1C3

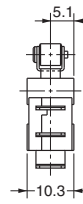
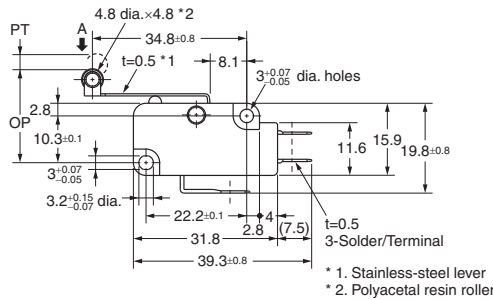
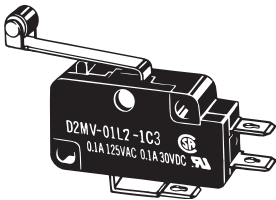

Operating characteristics	Model	
	D2MV-1L2-1C3	D2MV-01L2-1C3
Operating Force	OF Max.	0.29N (30 gf)
Releasing Force	RF Min.	0.02N (2 gf) (reference value)
Pretravel	PT Max.	3.3 mm
Overtravel	OT Min.	2.1 mm
Movement Differential	MD Max.	0.7 mm
Operating Position	OP	20.7±1.2 mm

Note. The indicated reference values of RF are for cases where the lever weight is not applied to the plunger.

Note 1. Unless otherwise specified, a tolerance of ±0.4mm applies to all dimensions.

Note 2. The operating characteristics are for operation in the A direction (↓).

## Precautions

★Please refer to "Basic Switches Common Precautions" for correct use.

### Cautions

#### ●Handling

Do not apply excessive shock. Doing so may cause damage to the Switch's internal components because they designed for a small load.

#### ●Soldering

- Terminal connections

Complete the soldering at the iron tip temperature between 250 to 350°C (60W) within 5 seconds, and do not apply any external force for 1 minute after soldering.

Apply minimum amount of flux required. It may result in contact failure once the flux penetrates into the internal part of the Switch.

### Correct Use

#### ●Mounting

Use M3 mounting screw with plane washers or spring washers to securely mount the Switch. Tighten the screws to a torque of 0.39 to 0.59 N·m {4 to 6 kgf·cm}.

#### ●Mounting Direction

For a Switch with an actuator, mount the Switch in a direction where the actuator weight will not be applied to the Switch. Since the Switch is designed for a low operating force, its release force is low. Therefore, release failure may occur if unnecessary force is applied to the Switch.

#### ●Using Micro Loads

Using a model for ordinary loads to open or close the contact of a micro load circuit may result in faulty contact. Use models that operate in the following range. However, even when using micro load models within the following operating range, if inrush current occurs when the contact is opened or closed, it may increase the contact wear and so decrease durability. Therefore, insert a contact protection circuit where necessary. The minimum applicable load is the N-level reference value. This value indicates the malfunction reference level for the reliability level of 60% ( $\lambda_{60}$ ).

(JIS C5003)

The equation,  $\lambda_{60}=0.5 \times 10^{-6} / \text{operations}$  indicates that the estimated malfunction rate is less than  $\frac{1}{2,000,000}$  operations with a reliability level of 60%.

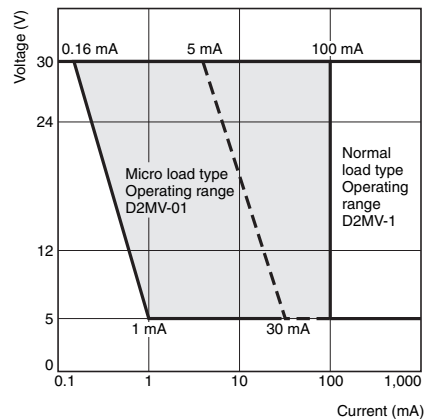

- Application examples provided in this document are for reference only. In actual applications, confirm equipment functions and safety before using the product.
- Consult your OMRON representative before using the product under conditions which are not described in the manual or applying the product to nuclear control systems, railroad systems, aviation systems, vehicles, combustion systems, medical equipment, amusement machines, safety equipment, and other systems or equipment that may have a serious influence on lives and property if used improperly. Make sure that the ratings and performance characteristics of the product provide a margin of safety for the system or equipment, and be sure to provide the system or equipment with double safety mechanisms.

**Note: Do not use this document to operate the Unit.**



Компания «ЭлектроПласт» предлагает заключение долгосрочных отношений при поставках импортных электронных компонентов на взаимовыгодных условиях!

Наши преимущества:

- Оперативные поставки широкого спектра электронных компонентов отечественного и импортного производства напрямую от производителей и с крупнейших мировых складов;
- Поставка более 17-ти миллионов наименований электронных компонентов;
- Поставка сложных, дефицитных, либо снятых с производства позиций;
- Оперативные сроки поставки под заказ (от 5 рабочих дней);
- Экспресс доставка в любую точку России;
- Техническая поддержка проекта, помощь в подборе аналогов, поставка прототипов;
- Система менеджмента качества сертифицирована по Международному стандарту ISO 9001;
- Лицензия ФСБ на осуществление работ с использованием сведений, составляющих государственную тайну;
- Поставка специализированных компонентов (Xilinx, Altera, Analog Devices, Intersil, Interpoint, Microsemi, Aeroflex, Peregrine, Syfer, Eurofarad, Texas Instrument, Miteq, Cobham, E2V, MA-COM, Hittite, Mini-Circuits, General Dynamics и др.);

Помимо этого, одним из направлений компании «ЭлектроПласт» является направление «Источники питания». Мы предлагаем Вам помощь Конструкторского отдела:

- Подбор оптимального решения, техническое обоснование при выборе компонента;
- Подбор аналогов;
- Консультации по применению компонента;
- Поставка образцов и прототипов;
- Техническая поддержка проекта;
- Защита от снятия компонента с производства.



#### Как с нами связаться

**Телефон:** 8 (812) 309 58 32 (многоканальный)

**Факс:** 8 (812) 320-02-42

**Электронная почта:** [org@eplast1.ru](mailto:org@eplast1.ru)

**Адрес:** 198099, г. Санкт-Петербург, ул. Калинина, дом 2, корпус 4, литера А.