

ISL9444EVAL1Z

Triple PWM Step-Down Synchronous Buck Controller

AN1712  
Rev 0.00  
December 22, 2011

**ISL9444EVAL1Z Evaluation Board**

The ISL9444EVAL1Z evaluation board (shown in Figure 1) features the ISL9444. The ISL9444 is a triple-output synchronous buck controller that integrates three PWM controllers. The ISL9444 offers external soft-start, independent enable functions and integrates UV/OV/OC/OT protection. Its current mode control architecture and internal compensation network keep peripheral component count minimal. Programmable switching frequency ranging from 200kHz to 1200kHz helps to optimize inductor size while the strong gate drivers deliver up to 25A for each PWM channel.

**Electrical Rating**

The ISL9444EVAL1Z evaluation board is designed for low current application. The current rating of the ISL9444EVAL1Z is limited by the FETs and inductors selected. The ISL9444 gate drivers are capable of delivering up to 25A for each PWM channel as long as the proper FETs and inductors are provided. The electrical ratings of ISL9444EVAL1Z are shown in Table 1.

TABLE 1. ELECTRICAL RATING

PARAMETER	RATING
Input Voltage	6V-20V
Switching Frequency	600kHz
PWM1 Output	1.05V @ max 6A
PWM2 Output	3.3V @ max 6A
PWM3 Output	1.8V @ max 6A

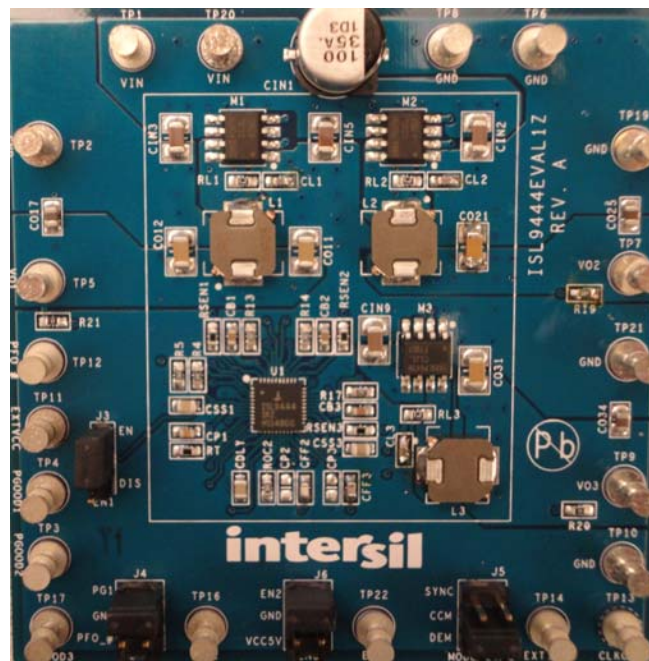

FIGURE 1. ISL9444EVAL1Z EVALUATION BOARD

## What's Inside

The Evaluation Board Kit contains the following materials:

- The ISL9444EVAL1Z
- The ISL9444 datasheet
- This EVAL KIT document

## Recommended Testing Equipment

The following materials are recommended to perform testing:

- 0V to 20V Power Supply with at least 10A Source Current Capability
- Three Electronic Loads Capable of Sinking Current up to 7A
- Digital Multimeters (DMMs)
- 100MHz Quad-Trace Oscilloscope

## Quick Test Guide

1. ISL9444 has a total of three PWM outputs. Jumpers J3, J4 and J6 provide rich options to control these three PWM outputs. Please refer to Table 2 for the desired operating option. The default option is to enable PWM1 when VCC5V is ready and then enable PWM2 and PWM3 simultaneously after PWM1 finishes start-up (i.e., PGOOD1 is high).
2. Ensure that the circuit is correctly connected to the supply and electronic loads prior to applying any power. Please refer to Figure 2 for proper set-up.
3. Turn on the power supply.
4. Adjust input voltage VIN within the specified range and observe output voltage. The output voltage variation should be within 3%.
5. Adjust load current within the specified range and observe output voltage. The output voltage variation should be within 3%.
6. Use an oscilloscope to observe output voltage ripple and Phase node ringing. For accurate measurement, please refer to Figure 3 for proper test set-up.

TABLE 2.

JUMPER #	POSITION	FUNCTION
J3	EN (Pin 1-2)	Enable PWM1 when VCC5V is ready.
	DIS (Pin 2-3)	Disable PWM1
J4	PG1 (Pin 1-2)	Enable PWM2 when PGOOD1 is high. If this option is chosen, PWM2 will be enabled after PWM1 finishes start-up.
	GND (Pin 3-4)	Disable PWM2
	PFO_# (Pin 5-6)	Enable PWM2 when PFI is high. In the ISL9444EVAL1Z, PFI is connected to the input voltage through a resistor divider. If this option is chosen, PWM2 will be enabled when the input voltage is around 6.4V
J6	EN2 (Pin 1-2)	Enable PWM3 when EN2 is high. In this option, PWM3 is tracking with PWM2.
	GND (Pin 3-4)	Disable PWM3
	VCC5V (Pin 5-6)	Enable PWM3 when VCC5V is ready.

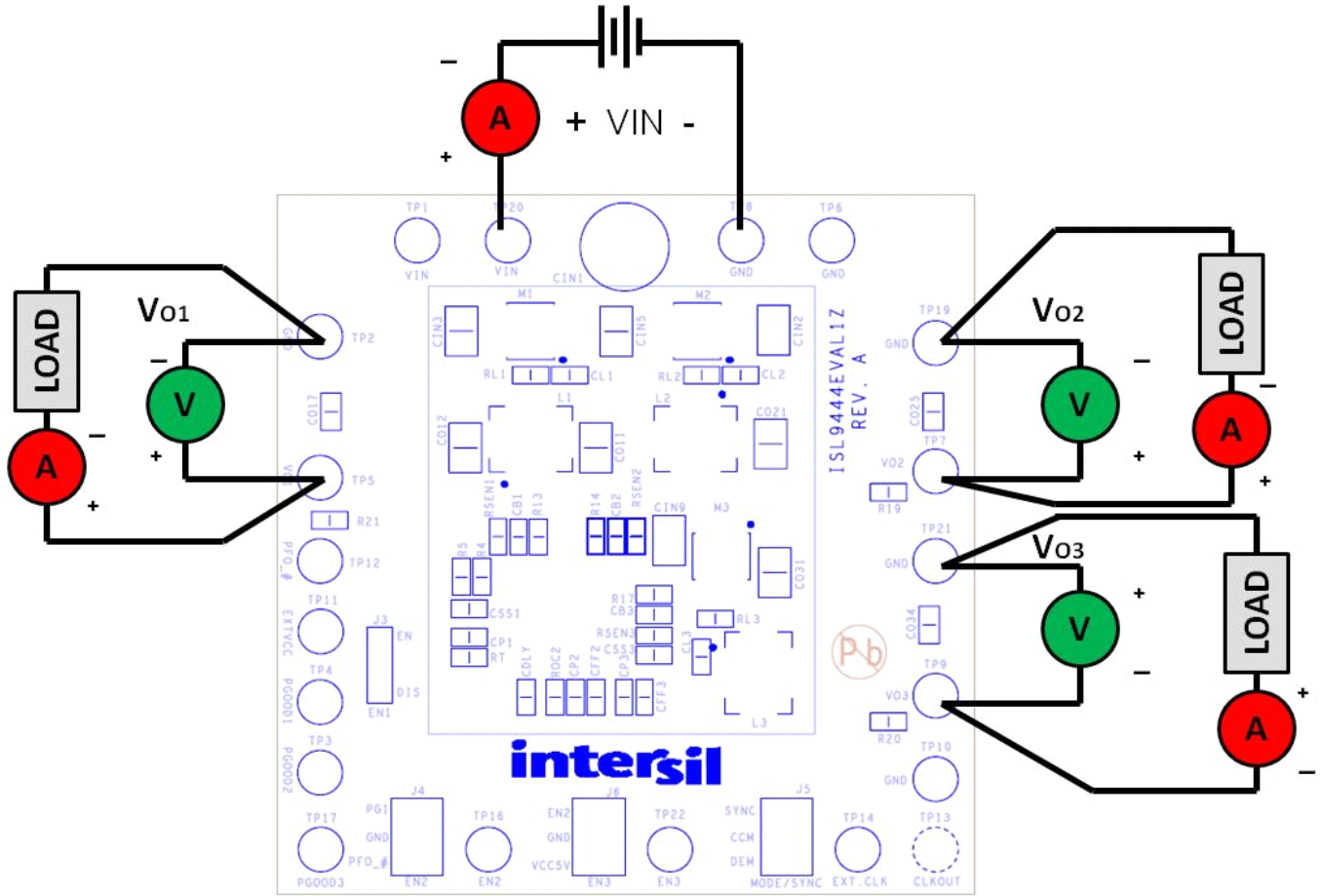

FIGURE 2. PROPER TEST SET-UP

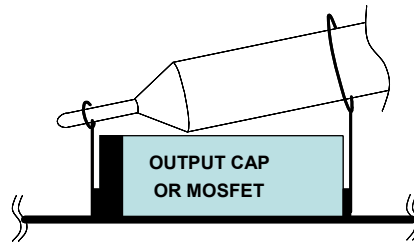

FIGURE 3. PROPER PROBE SET-UP TO MEASURE OUTPUT RIPPLE AND PHASE NODE RINGING

# Typical Evaluation Board Performance Curves $V_{IN} = 12V$ , unless otherwise noted.

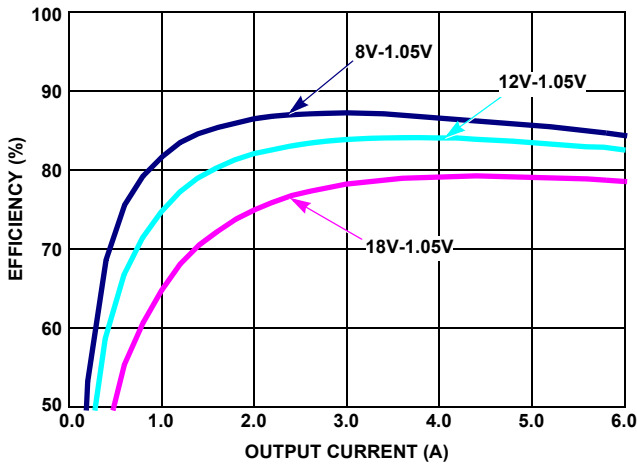

FIGURE 4. PWM1 EFFICIENCY vs LOAD ( $V_0 = 1.05V$ )

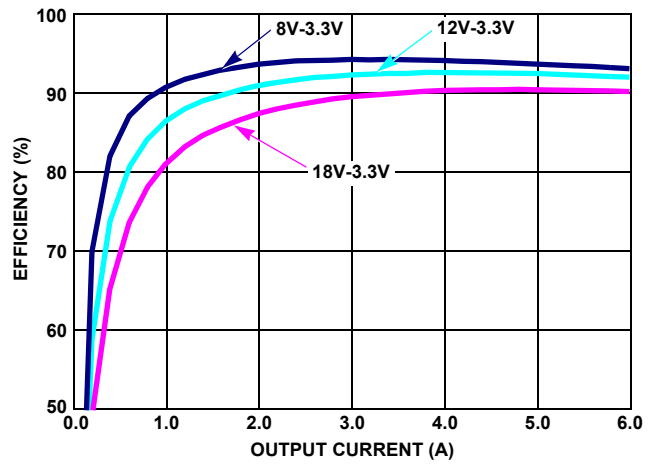

FIGURE 5. PWM2 EFFICIENCY vs LOAD ( $V_0 = 3.3V$ )

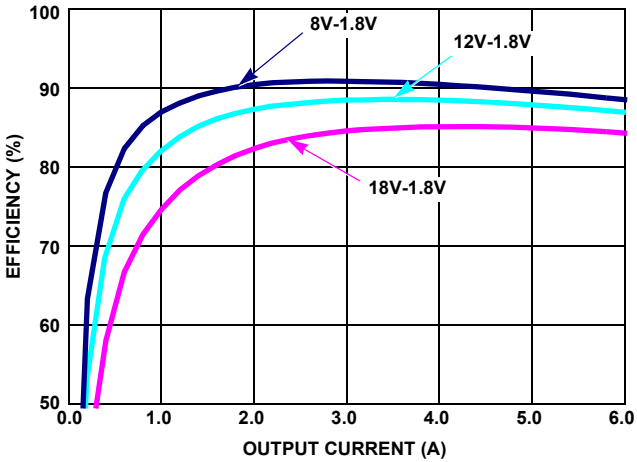

FIGURE 6. PWM3 EFFICIENCY vs LOAD ( $V_0 = 1.8V$ )

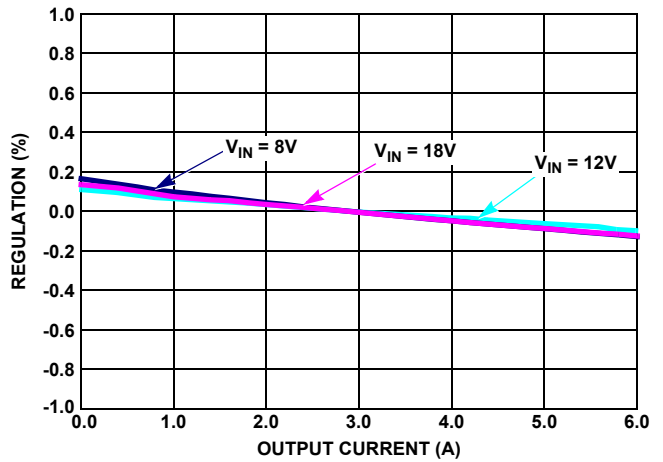

FIGURE 7. PWM1 LOAD REGULATION CURVES

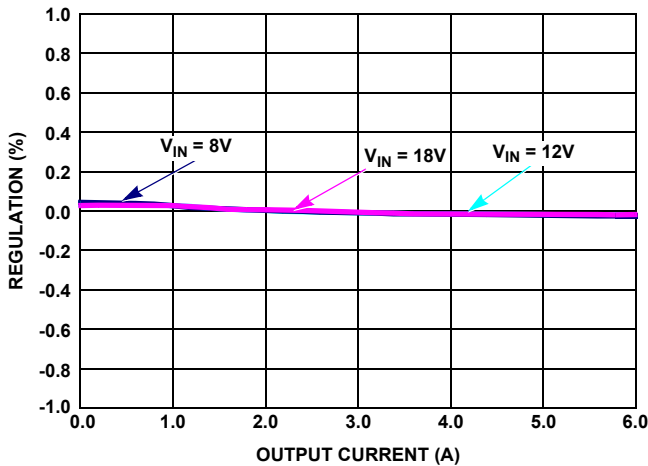

FIGURE 8. PWM2 LOAD REGULATION CURVES

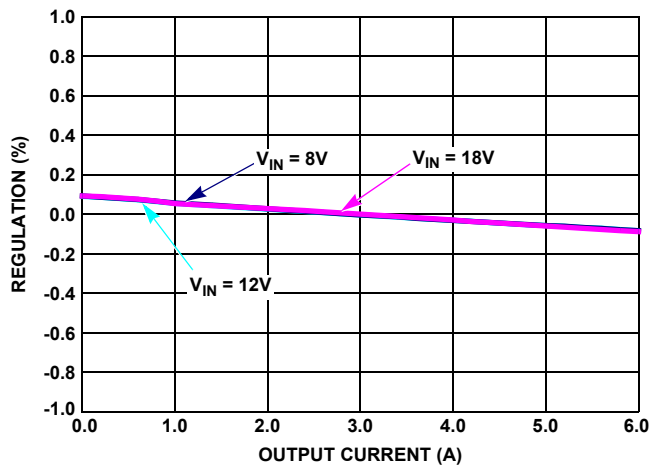
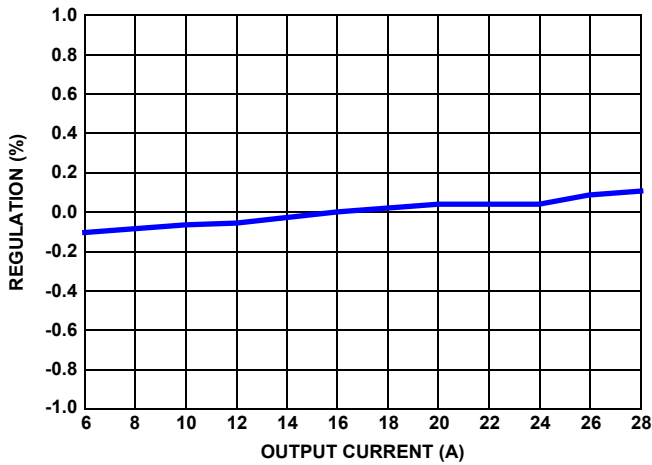
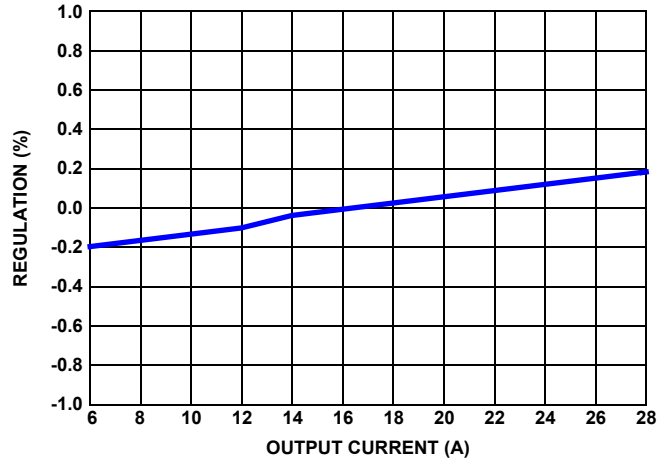

FIGURE 9. PWM3 LOAD REGULATION CURVES

**Typical Evaluation Board Performance Curves**  $V_{IN} = 12V$ , unless otherwise noted. (Continued)



**FIGURE 10. PWM1 LINE REGULATION CURVE**  
 $(V_{IN} = 12V, I_{O1} = I_{O2} = I_{O3} = 6A)$



**FIGURE 11. PWM2 LINE REGULATION CURVE**  
 $(V_{IN} = 12V, I_{O1} = I_{O2} = I_{O3} = 6A)$

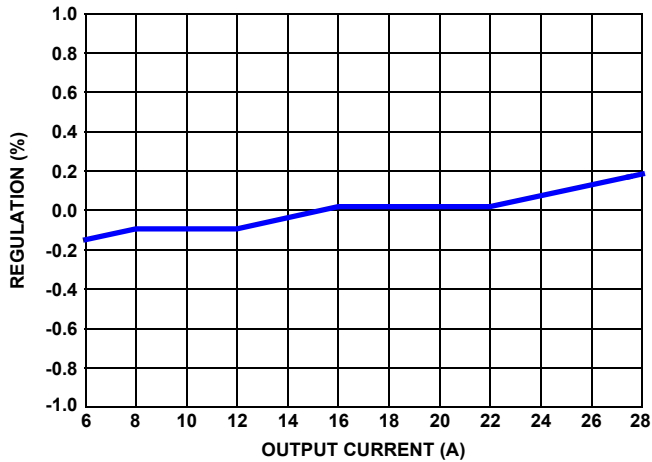

**FIGURE 12. PWM3 LINE REGULATION CURVE**  
 $(V_{IN} = 12V, I_{O1} = I_{O2} = I_{O3} = 6A)$

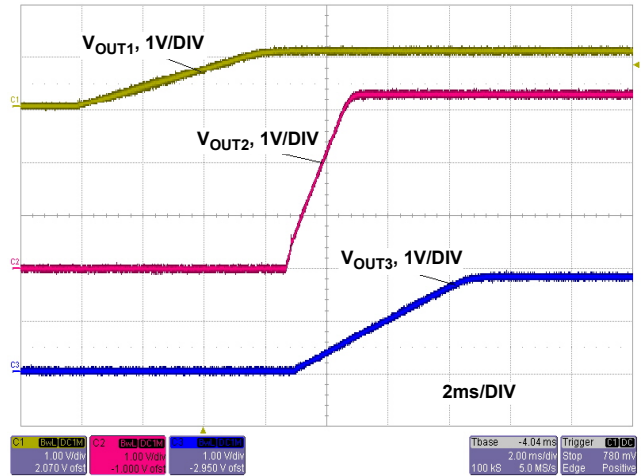

**FIGURE 13. SOFT-START CURVES**

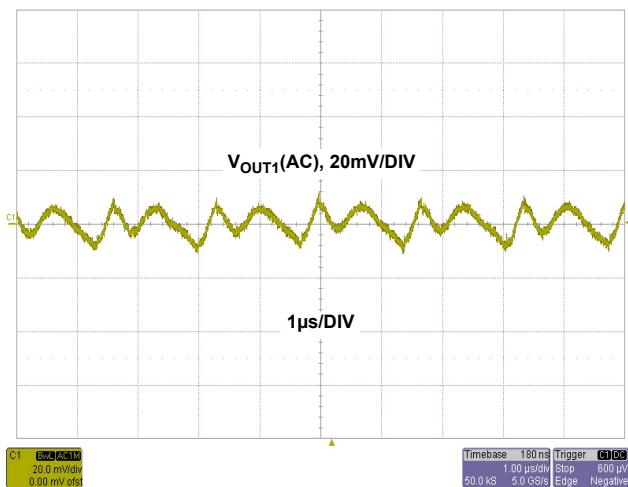

**FIGURE 14. PWM1 OUTPUT RIPPLE UNDER MAX LOAD**  
 $(V_{IN} = 12V, I_{O1} = I_{O2} = I_{O3} = 6A)$

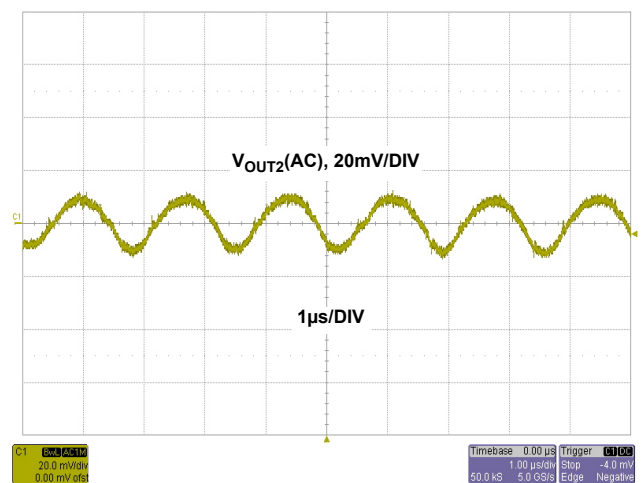

**FIGURE 15. PWM2 OUTPUT RIPPLE UNDER MAX LOAD**  
 $(V_{IN} = 12V, I_{O1} = I_{O2} = I_{O3} = 6A)$

# Typical Evaluation Board Performance Curves $V_{IN} = 12V$ , unless otherwise noted. (Continued)

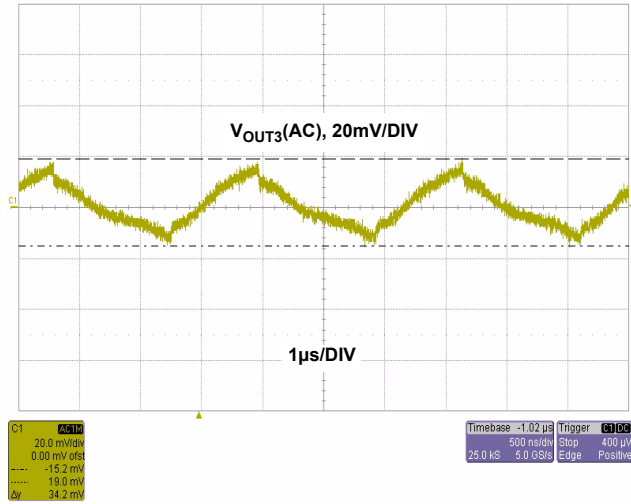
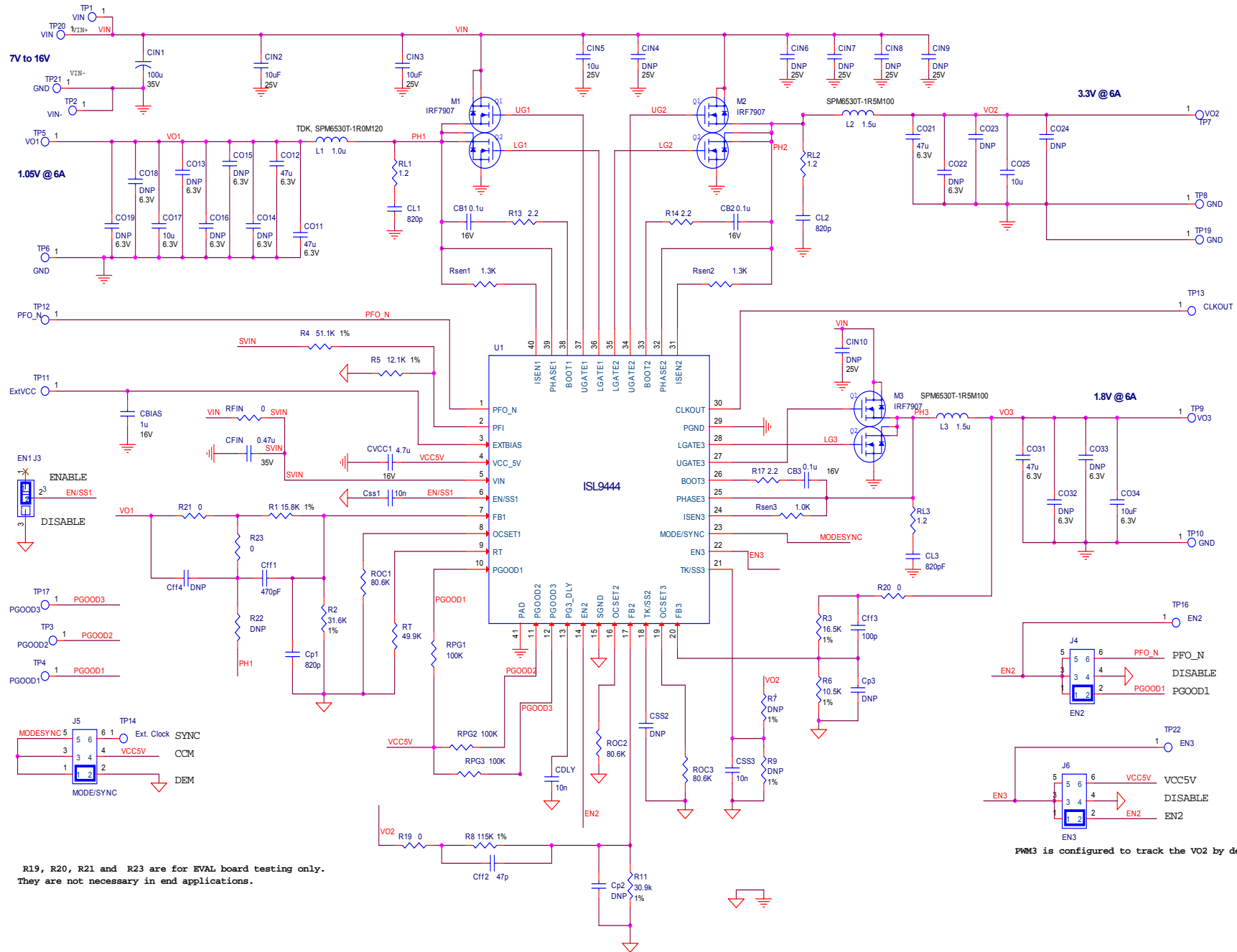

FIGURE 16. PWM3 OUTPUT RIPPLE UNDER MAX LOAD ( $V_{IN} = 12V$ ,  $I_{O1} = I_{O2} = I_{O3} = 6A$ )

# Schematic



R19, R20, R21 and R23 are for EVAL board testing only. They are not necessary in end applications.

PWM3 is configured to track the VO2 by default.

## ISL9444EVAL1Z BOM

PART NUMBER	QTY	UNITS	REFERENCE DESIGNATOR	DESCRIPTION	MANUFACTURER	MANUFACTURER PART
ISL9444EVAL1ZREVAPCB	1	ea		PWB-PCB, ISL9444EVAL1Z, REVA, ROHS	IMAGINEERING INC	ISL9444EVAL1ZREVAPCB
H1045-00101-50V5-T	1	ea	CFF3	CAP, SMD, 0603, 100pF, 50V, 5%, COG, ROHS	PANASONIC	ECJ-1VC1H101J
H1045-00104-50V10-T	3	ea	CB1, CB2, CB3	CAP, SMD, 0603, 0.1µF, 50V, 10%, X7R, ROHS	TDK	C1608X7R1H104K
H1045-00105-50V10-T	1	ea	CBIAS	CAP, SMD, 0603, 1µF, 50V, 10%, X5R, ROHS	TDK	C1608X5R1H105K
H1045-00470-50V5-T	1	ea	CFF2	CAP, SMD, 0603, 47pF, 50V, 5%, COG, NPO, ROHS	AVX	06035A470JAT2A
H1045-00471-50V10-T	1	ea	CFF1	CAP, SMD, 0603, 470pF, 50V, 10%, X7R, ROHS	VENKEL	C0603X7R500-471KNE
H1045-00474-50V10-T	1	ea	CFIN	CAP, SMD, 0603, 0.47µF, 50V, 10%, X7R, ROHS	TDK	C1608X7R1H474K
H1045-00821-50V10-T	1	ea	CP1	CAP, SMD, 0603, 820pF, 50V, 10%, X7R, ROHS	KEMET	C0603C821K5RACTU
H1045-00821-50V5-T	3	ea	CL1, CL2, CL3	CAP, SMD, 0603, 820pF, 50V, 5%, COG, ROHS	KEMET	C0603C821J5GACTU
H1046-00103-16V10-T	3	ea	CSS1, CSS3, CDLY	CAP, SMD, 0805, 0.01µF, 16V, 10%, X7R, ROHS	KEMET	C0805C103K4RACTU
H1046-00106-6R3V10-T	1	ea	C017, C025, C034	CAP, SMD, 0805, 10µF, 6.3V, 10%, X5R, ROHS	VENKEL	C0805X5R6R3-106KNE
H1046-00475-16V10-T	1	ea	CVCC1	CAP, SMD, 0805, 4.7µF, 16V, 10%, X5R, ROHS	PANASONIC	ECJ-2FB1C475K
H1065-00106-35V10-T	4	ea	CIN2, CIN3, CIN5, CIN9	CAP, SMD, 1206, 10µF, 35V, 10%, X5R, ROHS	VENKEL	C1206X5R350-106KNE
H1065-00476-6R3V20-T	4	ea	C011, C012, C021, C031	CAP, SMD, 1206, 47µF, 6.3V, 20%, X5R, ROHS	MURATA	GRM31CR60J476ME19L
EEE-1VA101UAP-T	1	ea	CIN1	CAP, SMD, 8x10.2, 100µF, 35V, 20%, ALUM.ELEC., ROHS	PANASONIC	EEE-1VA101UAP
SPM6530T-1R0M120-T	1	ea	L1	COIL-PWR INDUCTOR, SMD, 7.1x6.5, 1.0µH, 20%, 12A, ROHS	TDK	SPM6530T-1R0M120
SPM6530T-1R5M100-T	2	ea	L2, L3	COIL-PWR INDUCTOR, SMD, 7.1x6.5, 1.5µH, 20%, 11A, ROHS	TDK	SPM6530T-1R5M100
1514-2	20	ea	TP1-TP14, TP17, TP16, TP19, TP20, TP21, TP22	CONN-TURRET, TERMINAL POST, TH, ROHS	KEYSTONE	1514-2
67996-272HLF-2X3	3	ea	J4, J5, J6	CONN-HEADER, 2x3, BREAKAWY 2x36, 2.54mm, VERTICAL, ROHS	BERG/FCI	67996-272HLF
68000-236HLF-1X3	1	ea	J3	CONN-HEADER, 1x3, BREAKAWY 1x36, 2.54mm, ROHS	BERG/FCI	68000-236HLF
SPC02SYAN	4	ea	J3, J4, J5, J6	CONN-JUMPER, SHORTING, 2PIN, BLACK, GOLD, ROHS	SULLINS	SPC02SYAN
ISL9444IRZ	1	ea	U1	IC-STEP-DOWN CONTROLLER, 40P, QFN, 5x5, ROHS	INTERSIL	ISL9444IRZ
IRF7907PBF	3	ea	M1, M2, M3	TRANSIST-DUALMOS, N-CHANNEL, 8P, SOIC, 30V, 9.1A, ROHS	INTERNATIONAL RECTIFIER	IRF7907PBF
H2511-001R2-1/10W1-T	3	ea	RL1, RL2, RL3	RES, SMD, 0603, 1.2Ω, 1/10W, 1%, TF, ROHS	PANASONIC	ERJ-3RQF1R2V



**ISL9444EVAL1Z BOM** (Continued)

PART NUMBER	QTY	UNITS	REFERENCE DESIGNATOR	DESCRIPTION	MANUFACTURER	MANUFACTURER PART
H2511-002R2-1/10W1-T	3	ea	R13, R14, R17	RES, SMD, 0603, 2.2Ω, 1/10W, 1%, TF, ROHS	PANASONIC	ERJ-3RQF2R2V
H2511-00R00-1/10W-T	5	ea	RFIN, R21, R23, R19, R20	RES, SMD, 0603, 0Ω, 1/10W, TF, ROHS	VENKEL	CR0603-10W-000T
H2511-01001-1/10W1-T	1	ea	RSEN3	RES, SMD, 0603, 1k, 1/10W, 1%, TF, ROHS	PANASONIC	ERJ-3EKF1001V
H2511-01003-1/10W1-T	3	ea	RPG1, RPG2, RPG3	RES, SMD, 0603, 100k, 1/10W, 1%, TF, ROHS	VENKEL	CR0603-10W-1003FT
H2511-01052-1/10W1-T	1	ea	R6	RES, SMD, 0603, 10.5k, 1/10W, 1%, TF, ROHS	YAGEO	RC0603FR-0710K5L
H2511-01153-1/10W1-T	1	ea	R8	RES, SMD, 0603, 115k, 1/10W, 1%, TF, ROHS	PANASONIC	ERJ-3EKF1153V
H2511-01212-1/10W1-T	1	ea	R5	RES, SMD, 0603, 12.1k, 1/10W, 1%, TF, ROHS	VENKEL	CR0603-10W-1212FT
H2511-01301-1/10W1-T	2	ea	RSEN1, RSEN2	RES, SMD, 0603, 1.3k, 1/10W, 1%, TF, ROHS	VISHAY/DALE	CRCW06031K30FKTA
H2511-01582-1/10W1-T	1	ea	R1	RES, SMD, 0603, 15.8 k, 1/10W, 1%, TF, ROHS	VENKEL	CR0603-10W-1582FT
H2511-01652-1/10W1-T	1	ea	R3	RES, SMD, 0603, 16.5k, 1/10W, 1%, TF, ROHS	PANASONIC	ERJ-3EKF1652V
H2511-03092-1/10W1-T	1	ea	R11	RES, SMD, 0603, 30.9k, 1/10W, 1%, TF, ROHS	YAGEO	RC0603FR-0730K9L
H2511-03162-1/10W1-T	1	ea	R2	RES, SMD, 0603, 31.6k, 1/10W, 1%, TF, ROHS	VISHAY	CRCW06033162F
H2511-04992-1/10W1-T	1	ea	RT	RES, SMD, 0603, 49.9k, 1/10W, 1%, TF, ROHS	VENKEL	CR0603-10W-4992FT
H2511-05112-1/10W1-T	1	ea	R4	RES, SMD, 0603, 51.1k, 1/10W, 1%, TF, ROHS	VENKEL	CR0603-10W-5112FT
H2511-08062-1/10W1-T	3	ea	ROC1, ROC2, ROC3	RES, SMD, 0603, 80.6k, 1/10W, 1%, TF, ROHS	PANASONIC	ERJ-3EKF8062V
5X8-STATIC-BAG	1	ea	Place assy in bag	BAG, STATIC, 5x8, ZIPLOC, ROHS	INTERSIL	212403-013
DNP	0	ea	R7, R9, R22	DO NOT POPULATE OR PURCHASE		
DNP	0	ea	a) CFF4, CIN4, CIN6, CIN7, CIN8, CIN10	DO NOT POPULATE OR PURCHASE		
DNP	0	ea	b) CP2, CP3, CSS2, C013, - C016, C018	DO NOT POPULATE OR PURCHASE		
DNP	0	ea	c) C019, C022, C023, C024, C032, C033	DO NOT POPULATE OR PURCHASE		
LABEL-DATE CODE	1	ea		LABEL-FOR DATE CODE AND BOM REV #	INTERSIL	LABEL-DATE CODE

# ISL9444EVAL1Z PCB Layout

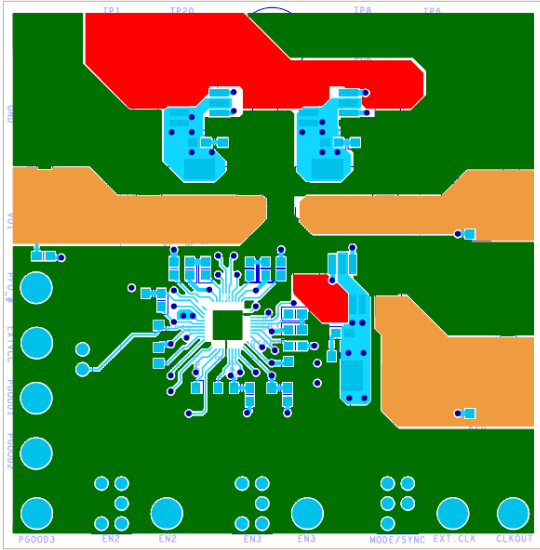

FIGURE 17. TOP LAYER

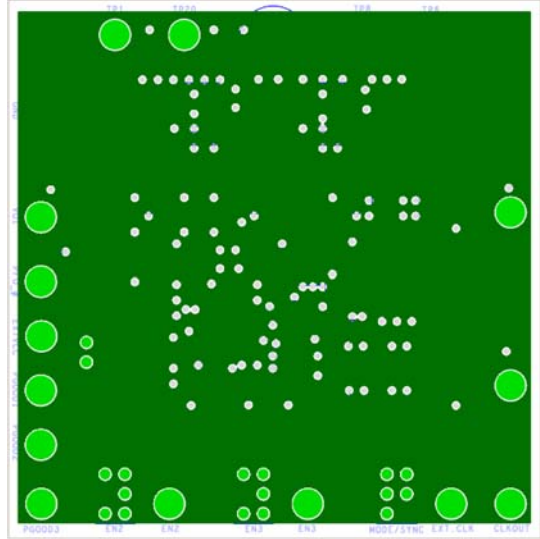

FIGURE 18. SECOND LAYER (SOLID GROUND)

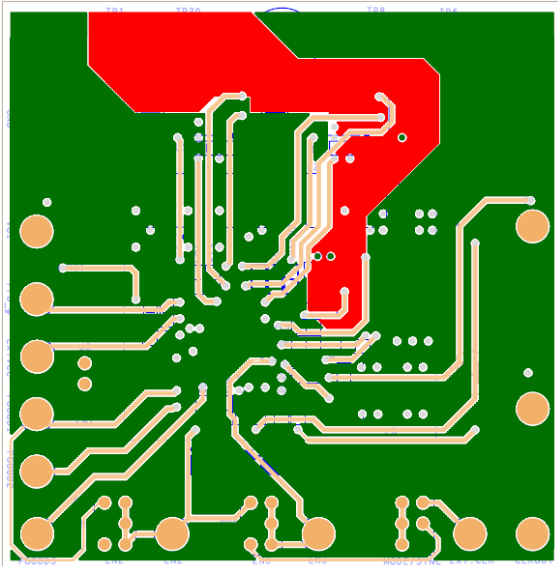

FIGURE 19. THIRD LAYER

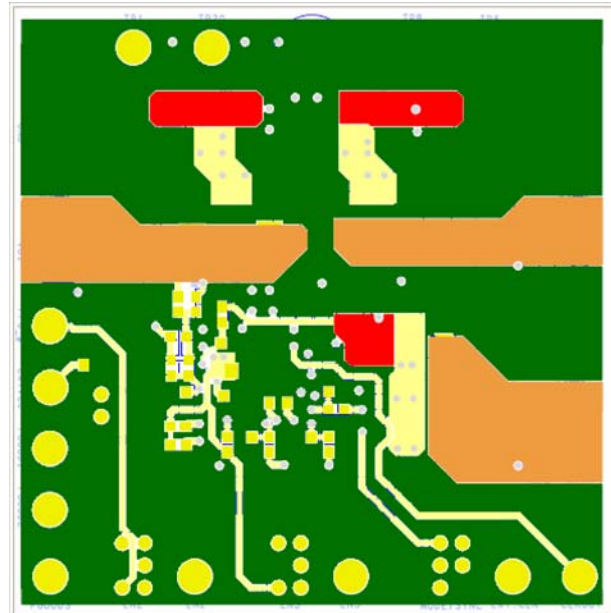

FIGURE 20. BOTTOM LAYER

## Notice

1. Descriptions of circuits, software and other related information in this document are provided only to illustrate the operation of semiconductor products and application examples. You are fully responsible for the incorporation or any other use of the circuits, software, and information in the design of your product or system. Renesas Electronics disclaims any and all liability for any losses and damages incurred by you or third parties arising from the use of these circuits, software, or information.
2. Renesas Electronics hereby expressly disclaims any warranties against and liability for infringement or any other claims involving patents, copyrights, or other intellectual property rights of third parties, by or arising from the use of Renesas Electronics products or technical information described in this document, including but not limited to, the product data, drawings, charts, programs, algorithms, and application examples.
3. No license, express, implied or otherwise, is granted hereby under any patents, copyrights or other intellectual property rights of Renesas Electronics or others.
4. You shall not alter, modify, copy, or reverse engineer any Renesas Electronics product, whether in whole or in part. Renesas Electronics disclaims any and all liability for any losses or damages incurred by you or third parties arising from such alteration, modification, copying or reverse engineering.
5. Renesas Electronics products are classified according to the following two quality grades: "Standard" and "High Quality". The intended applications for each Renesas Electronics product depends on the product's quality grade, as indicated below.  
"Standard": Computers; office equipment; communications equipment; test and measurement equipment; audio and visual equipment; home electronic appliances; machine tools; personal electronic equipment; industrial robots; etc.  
"High Quality": Transportation equipment (automobiles, trains, ships, etc.); traffic control (traffic lights); large-scale communication equipment; key financial terminal systems; safety control equipment; etc.  
Unless expressly designated as a high reliability product or a product for harsh environments in a Renesas Electronics data sheet or other Renesas Electronics document, Renesas Electronics products are not intended or authorized for use in products or systems that may pose a direct threat to human life or bodily injury (artificial life support devices or systems; surgical implantations; etc.), or may cause serious property damage (space system; undersea repeaters; nuclear power control systems; aircraft control systems; key plant systems; military equipment; etc.). Renesas Electronics disclaims any and all liability for any damages or losses incurred by you or any third parties arising from the use of any Renesas Electronics product that is inconsistent with any Renesas Electronics data sheet, user's manual or other Renesas Electronics document.
6. When using Renesas Electronics products, refer to the latest product information (data sheets, user's manuals, application notes, "General Notes for Handling and Using Semiconductor Devices" in the reliability handbook, etc.), and ensure that usage conditions are within the ranges specified by Renesas Electronics with respect to maximum ratings, operating power supply voltage range, heat dissipation characteristics, installation, etc. Renesas Electronics disclaims any and all liability for any malfunctions, failure or accident arising out of the use of Renesas Electronics products outside of such specified ranges.
7. Although Renesas Electronics endeavors to improve the quality and reliability of Renesas Electronics products, semiconductor products have specific characteristics, such as the occurrence of failure at a certain rate and malfunctions under certain use conditions. Unless designated as a high reliability product or a product for harsh environments in a Renesas Electronics data sheet or other Renesas Electronics document, Renesas Electronics products are not subject to radiation resistance design. You are responsible for implementing safety measures to guard against the possibility of bodily injury, injury or damage caused by fire, and/or danger to the public in the event of a failure or malfunction of Renesas Electronics products, such as safety design for hardware and software, including but not limited to redundancy, fire control and malfunction prevention, appropriate treatment for aging degradation or any other appropriate measures. Because the evaluation of microcomputer software alone is very difficult and impractical, you are responsible for evaluating the safety of the final products or systems manufactured by you.
8. Please contact a Renesas Electronics sales office for details as to environmental matters such as the environmental compatibility of each Renesas Electronics product. You are responsible for carefully and sufficiently investigating applicable laws and regulations that regulate the inclusion or use of controlled substances, including without limitation, the EU RoHS Directive, and using Renesas Electronics products in compliance with all these applicable laws and regulations. Renesas Electronics disclaims any and all liability for damages or losses occurring as a result of your noncompliance with applicable laws and regulations.
9. Renesas Electronics products and technologies shall not be used for or incorporated into any products or systems whose manufacture, use, or sale is prohibited under any applicable domestic or foreign laws or regulations. You shall comply with any applicable export control laws and regulations promulgated and administered by the governments of any countries asserting jurisdiction over the parties or transactions.
10. It is the responsibility of the buyer or distributor of Renesas Electronics products, or any other party who distributes, disposes of, or otherwise sells or transfers the product to a third party, to notify such third party in advance of the contents and conditions set forth in this document.
11. This document shall not be reprinted, reproduced or duplicated in any form, in whole or in part, without prior written consent of Renesas Electronics.
12. Please contact a Renesas Electronics sales office if you have any questions regarding the information contained in this document or Renesas Electronics products.  
(Note 1) "Renesas Electronics" as used in this document means Renesas Electronics Corporation and also includes its directly or indirectly controlled subsidiaries.  
(Note 2) "Renesas Electronics product(s)" means any product developed or manufactured by or for Renesas Electronics.

(Rev.4.0-1 November 2017)



### SALES OFFICES

Renesas Electronics Corporation

<http://www.renesas.com>

Refer to "<http://www.renesas.com/>" for the latest and detailed information.

**Renesas Electronics America Inc.**  
1001 Murphy Ranch Road, Milpitas, CA 95035, U.S.A.  
Tel: +1-408-432-8888, Fax: +1-408-434-5351

**Renesas Electronics Canada Limited**  
9251 Yonge Street, Suite 8309 Richmond Hill, Ontario Canada L4C 9T3  
Tel: +1-905-237-2004

**Renesas Electronics Europe Limited**  
Dukes Meadow, Millboard Road, Bourne End, Buckinghamshire, SL8 5FH, U.K  
Tel: +44-1628-651-700, Fax: +44-1628-651-804

**Renesas Electronics Europe GmbH**  
Arcadiastrasse 10, 40472 Düsseldorf, Germany  
Tel: +49-211-6503-0, Fax: +49-211-6503-1327

**Renesas Electronics (China) Co., Ltd.**  
Room 1709 Quantum Plaza, No.27 ZhichunLu, Haidian District, Beijing, 100191 P. R. China  
Tel: +86-10-8235-1155, Fax: +86-10-8235-7679

**Renesas Electronics (Shanghai) Co., Ltd.**  
Unit 301, Tower A, Central Towers, 555 Langao Road, Putuo District, Shanghai, 200333 P. R. China  
Tel: +86-21-2226-0888, Fax: +86-21-2226-0999

**Renesas Electronics Hong Kong Limited**  
Unit 1601-1611, 16/F., Tower 2, Grand Century Place, 193 Prince Edward Road West, Mongkok, Kowloon, Hong Kong  
Tel: +852-2265-6688, Fax: +852-2886-9022

**Renesas Electronics Taiwan Co., Ltd.**  
13F, No. 363, Fu Shing North Road, Taipei 10543, Taiwan  
Tel: +886-2-8175-9600, Fax: +886-2-8175-9670

**Renesas Electronics Singapore Pte. Ltd.**  
80 Bendemeer Road, Unit #06-02 Hyflux Innovation Centre, Singapore 339949  
Tel: +65-6213-0200, Fax: +65-6213-0300

**Renesas Electronics Malaysia Sdn.Bhd.**  
Unit 1207, Block B, Menara Amcorp, Amcorp Trade Centre, No. 18, Jln Persiaran Barat, 46050 Petaling Jaya, Selangor Darul Ehsan, Malaysia  
Tel: +60-3-7955-9390, Fax: +60-3-7955-9510

**Renesas Electronics India Pvt. Ltd.**  
No.777C, 100 Feet Road, HAL 2nd Stage, Indiranagar, Bangalore 560 038, India  
Tel: +91-80-67208700, Fax: +91-80-67208777

**Renesas Electronics Korea Co., Ltd.**  
17F, KAMCO Yangjae Tower, 262, Gangnam-daero, Gangnam-gu, Seoul, 06265 Korea  
Tel: +82-2-558-3737, Fax: +82-2-558-5338



Компания «ЭлектроПласт» предлагает заключение долгосрочных отношений при поставках импортных электронных компонентов на взаимовыгодных условиях!

Наши преимущества:

- Оперативные поставки широкого спектра электронных компонентов отечественного и импортного производства напрямую от производителей и с крупнейших мировых складов;
- Поставка более 17-ти миллионов наименований электронных компонентов;
- Поставка сложных, дефицитных, либо снятых с производства позиций;
- Оперативные сроки поставки под заказ (от 5 рабочих дней);
- Экспресс доставка в любую точку России;
- Техническая поддержка проекта, помощь в подборе аналогов, поставка прототипов;
- Система менеджмента качества сертифицирована по Международному стандарту ISO 9001;
- Лицензия ФСБ на осуществление работ с использованием сведений, составляющих государственную тайну;
- Поставка специализированных компонентов (Xilinx, Altera, Analog Devices, Intersil, Interpoint, Microsemi, Aeroflex, Peregrine, Syfer, Eurofarad, Texas Instrument, Miteq, Cobham, E2V, MA-COM, Hittite, Mini-Circuits, General Dynamics и др.);

Помимо этого, одним из направлений компании «ЭлектроПласт» является направление «Источники питания». Мы предлагаем Вам помощь Конструкторского отдела:

- Подбор оптимального решения, техническое обоснование при выборе компонента;
- Подбор аналогов;
- Консультации по применению компонента;
- Поставка образцов и прототипов;
- Техническая поддержка проекта;
- Защита от снятия компонента с производства.



#### Как с нами связаться

**Телефон:** 8 (812) 309 58 32 (многоканальный)

**Факс:** 8 (812) 320-02-42

**Электронная почта:** [org@eplast1.ru](mailto:org@eplast1.ru)

**Адрес:** 198099, г. Санкт-Петербург, ул. Калинина, дом 2, корпус 4, литера А.