

RF Power GaN Transistors

These 300 W CW GaN transistors are designed for industrial, scientific and medical (ISM) applications at 2450 MHz. These devices are suitable for use in CW, pulse, cycling and linear applications. These high gain, high efficiency devices can replace industrial magnetrons and will provide longer life and ease of use.

This part is characterized and performance is guaranteed for applications operating in the 2400 to 2500 MHz band. There is no guarantee of performance when this part is used in applications designed outside of these frequencies.

Typical Performance: In 2400–2500 MHz MRF24G300HS reference circuit, $V_{DD} = 48$ Vdc, $V_{GS(A+B)} = -5$ Vdc (1)

Frequency (MHz)	Signal Type	P_{in} (W)	P_{out} (W)	G_{ps} (dB)	η_D (%)
2400	CW	10.0	336	15.3	70.4
2450		10.0	332	15.2	73.0
2500		10.0	307	14.9	74.4

1. All data measured in fixture with device soldered to heatsink.

Load Mismatch/Ruggedness

Frequency (MHz)	Signal Type	VSWR	P_{in} (W)	Test Voltage	Result
2450	Pulse (100 μ sec, 20% Duty Cycle)	> 20:1 at All Phase Angles	12.6 Peak	55	No Device Degradation

Features

- Advanced GaN on SiC, for optimal thermal performance
- Characterized for CW, long pulse (up to several seconds) and short pulse operations
- Device can be used in a single-ended or push-pull configuration
- Input matched for simplified input circuitry
- Qualified up to 55 V
- Suitable for linear application

Typical Applications

- Industrial heating
- Welding and heat sealing
- Plasma generation
- Lighting
- Scientific instrumentation
- Medical
 - Microwave ablation
 - Diathermy

MRF24G300HS MRF24G300H

PREPRODUCTION

2400–2500 MHz, 300 W CW, 50 V
WIDEBAND
RF POWER GaN TRANSISTORS

NI-780S-4L
MRF24G300HS

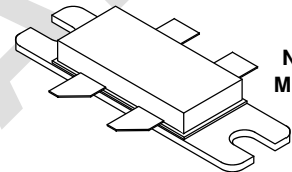
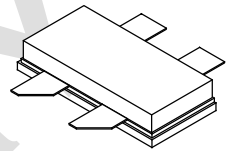

NI-780H-4L
MRF24G300H

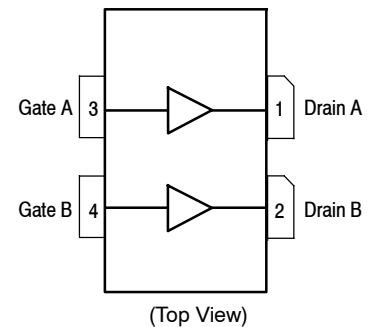

Note: The backside of the package is the source terminal for the transistor.

Figure 1. Pin Connections

This document contains information on a preproduction product. Specifications and information herein are subject to change without notice.

Table 1. Maximum Ratings

Rating	Symbol	Value	Unit
Drain-Source Voltage	V_{DSS}	125	Vdc
Gate-Source Voltage	V_{GS}	-8, 0	Vdc
Operating Voltage	V_{DD}	0 to +55	Vdc
Maximum Forward Gate Current, I_G (A+B), @ $T_C = 25^\circ\text{C}$	I_{GMAX}	42	mA
Storage Temperature Range	T_{stg}	-65 to +150	$^\circ\text{C}$
Case Operating Temperature Range	T_C	-55 to +150	$^\circ\text{C}$
Maximum Channel Temperature (1)	T_{CH}	350	$^\circ\text{C}$

Table 2. Thermal Characteristics

Characteristic	Symbol	Value	Unit
Thermal Resistance by Finite Element Analysis, Channel-to-Case Case Temperature 90°C , $P_D = 125\text{ W}$	$R_{\theta CHC}$ (FEA)	0.78 (2,3)	$^\circ\text{C/W}$

Table 3. Electrical Characteristics ($T_A = 25^\circ\text{C}$ unless otherwise noted)

Characteristic	Symbol	Min	Typ	Max	Unit
----------------	--------	-----	-----	-----	------

Off Characteristics (4)

Drain-Source Breakdown Voltage ($V_{GS} = -8\text{ Vdc}$, $I_D = 48.6\text{ mAdc}$)	$V_{(BR)DSS}$	150	—	—	Vdc
---	---------------	-----	---	---	-----

On Characteristics (4)

Gate Threshold Voltage ($V_{DS} = 10\text{ Vdc}$, $I_D = 22\text{ mAdc}$)	$V_{GS(th)}$	-3.8	-3.12	-2.3	Vdc
Gate-Source Leakage Current ($V_{DS} = 0\text{ Vdc}$, $V_{GS} = -5\text{ Vdc}$)	I_{GSS}	-15.0	—	—	mAdc

- Reliability tests were conducted at 225°C . Operation with T_{CH} at 350°C will reduce median time to failure.
- $R_{\theta CHC}$ (FEA) must be used for purposes related to reliability and limitations on maximum channel temperature. MTTF may be estimated by the expression $MTTF$ (hours) = $10^{[A + B/(T + 273)]}$, where T is the channel temperature in degrees Celsius, $A = -10.3$ and $B = 8260$.
- Data is based on preliminary results and is subject to change.
- Each side of device measured separately.

NOTE: Correct Biasing Sequence for GaN Depletion Mode Transistors

Turning the device ON

1. Set V_{GS} to -5 V
2. Turn on V_{DS} to nominal supply voltage (50 V)
3. For Class AB operations increase V_{GS} until desired I_{DS} current is attained
4. Apply RF input power to desired level

Turning the device OFF

1. Turn RF power off
2. Reduce V_{GS} down to -5 V
3. Reduce V_{DS} down to 0 V (Adequate time must be allowed for V_{DS} to reduce to 0 V to prevent severe damage to device.)
4. Turn off V_{GS}

PRELIMINARY

MRF24G300HS 2400–2500 MHz REFERENCE CIRCUIT — 2.0" × 2.8" (5.0 cm × 7.0 cm)

Table 4. 2400–2500 MHz Performance ⁽¹⁾ (In NXP MRF24G300HS Reference Circuit, 50 ohm system)

$V_{DD} = 48$ Vdc, $V_{GS(A+B)} = -5$ Vdc, $P_{in} = 10$ W, CW

Frequency (MHz)	P_{out} (W)	G_{ps} (dB)	η_D (%)
2400	336	15.3	70.4
2450	332	15.2	73.0
2500	307	14.9	74.4

1. All data measured in fixture with device soldered to heatsink.

PRELIMINARY

MRF24G300HS 2400–2500 MHz REFERENCE CIRCUIT — 2.0" x 2.8" (5.0 cm x 7.0 cm)

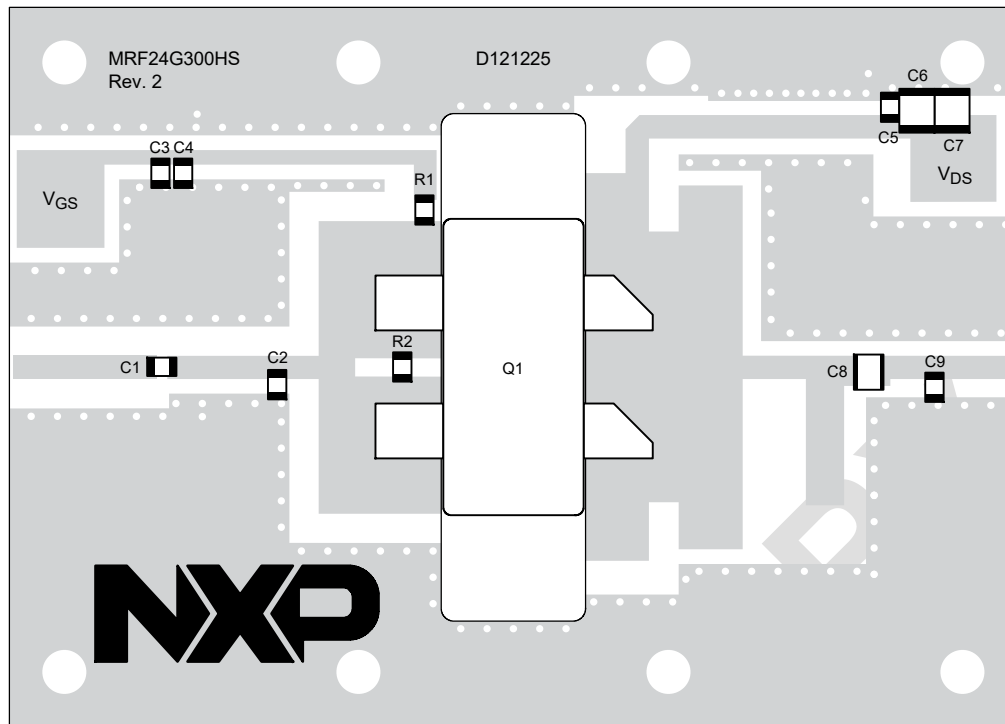

Note: All data measured in fixture with device soldered to heatsink.

aaa-033536

Figure 2. MRF24G300HS Reference Circuit Component Layout — 2400–2500 MHz

Table 5. MRF24G300HS Reference Circuit Component Designations and Values — 2400–2500 MHz

Part	Description	Part Number	Manufacturer
C1, C4	20 pF Chip Capacitor	600F200JT250XT	ATC
C2	1.2 pF Chip Capacitor	600F1R2BT250XT	ATC
C3	1.0 μ F Chip Capacitor	GCM21BR71H105KA03L	Murata
C5	27 pF Chip Capacitor	600F270JT250XT	ATC
C6, C7	10 μ F Chip Capacitor	GRM32EC72A106KE05L	Murata
C8	10 pF Chip Capacitor	800R100JT500XT	ATC
C9	0.1 pF Chip Capacitor	600F0R1BT250XT	ATC
Q1	RF Power GaN Transistor	MRF24G300HS	NXP
R1	10 Ω , 1/4 W Chip Resistor	CRCW120610R0JNEA	Vishay
R2	5.1 Ω , 1/8 W Chip Resistor	CRCW08055R10JNEA	Vishay
PCB	Rogers RT6035HTC 0.030", $\epsilon_r = 3.5$, 2 oz. Copper	D121225	MTL

**TYPICAL CHARACTERISTICS — 2400–2500 MHz
MRF24G300HS REFERENCE CIRCUIT**

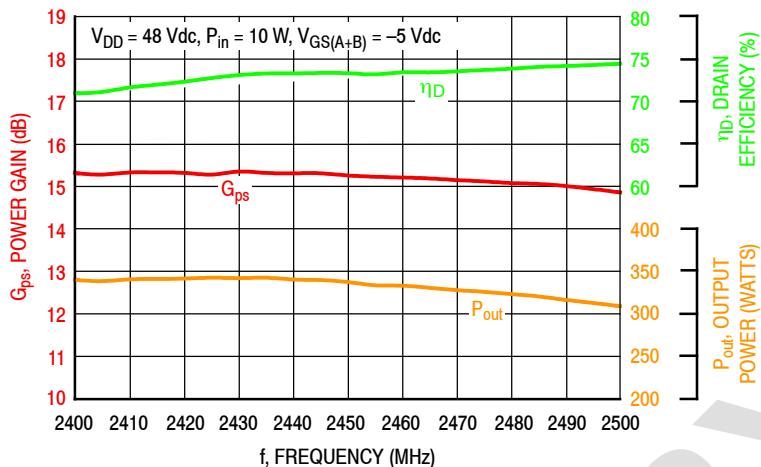

Figure 3. Power Gain, Drain Efficiency and CW Output Power versus Frequency at a Constant Input Power

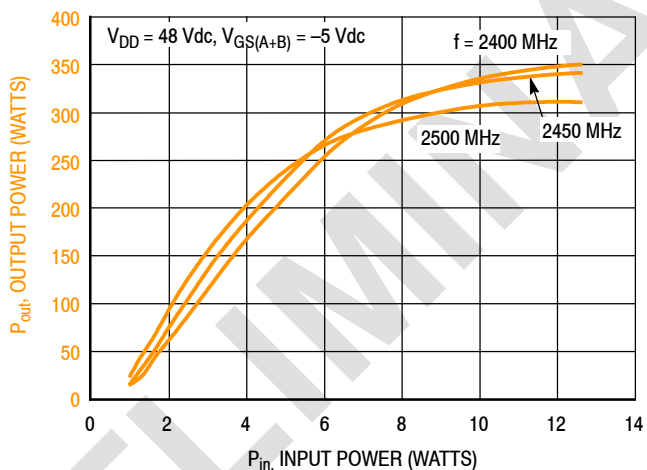

Figure 4. CW Output Power versus Input Power and Frequency

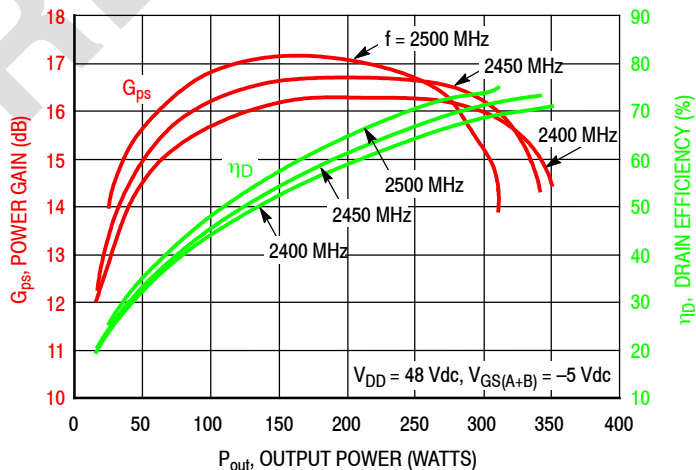

Figure 5. Power Gain and Drain Efficiency versus CW Output Power and Frequency

2400–2500 MHz REFERENCE CIRCUIT

f (MHz)	Z_{source} (Ω)	Z_{load} (Ω)
2400	$2.55 - j2.96$	$2.41 - j3.12$
2450	$2.55 - j2.72$	$2.13 - j2.98$
2500	$2.56 - j2.49$	$1.88 - j2.80$

Z_{source} = Test circuit impedance as measured from gate to ground.

Z_{load} = Test circuit impedance as measured from drain to ground.

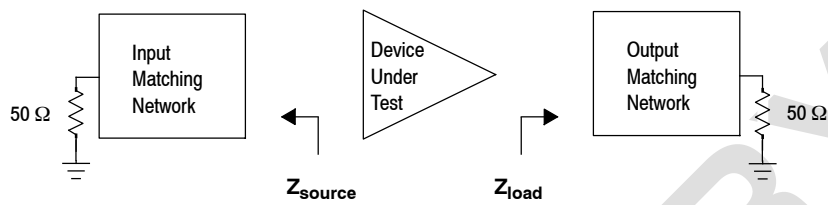
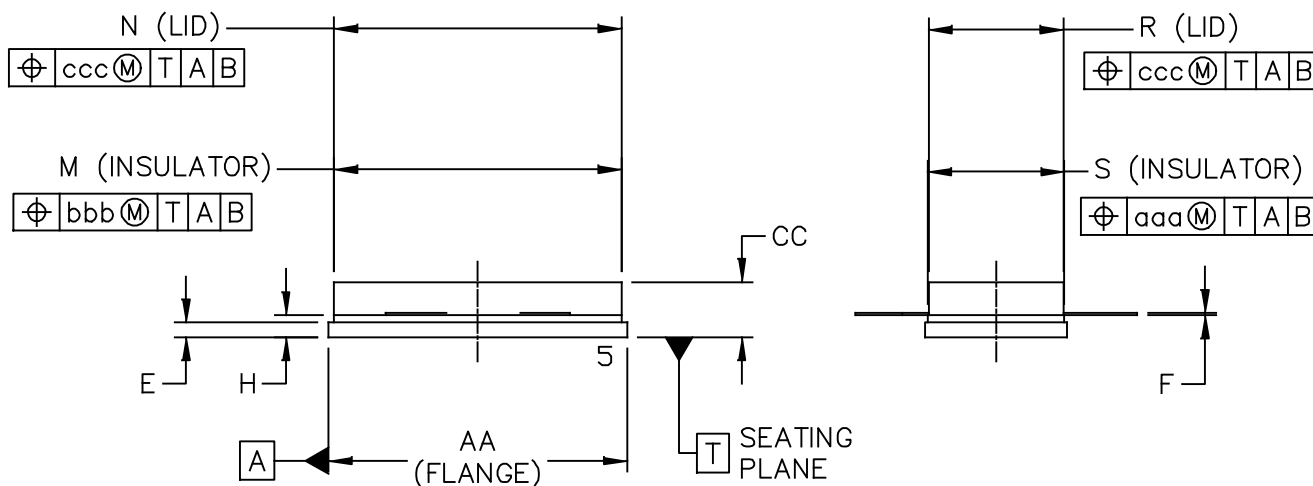
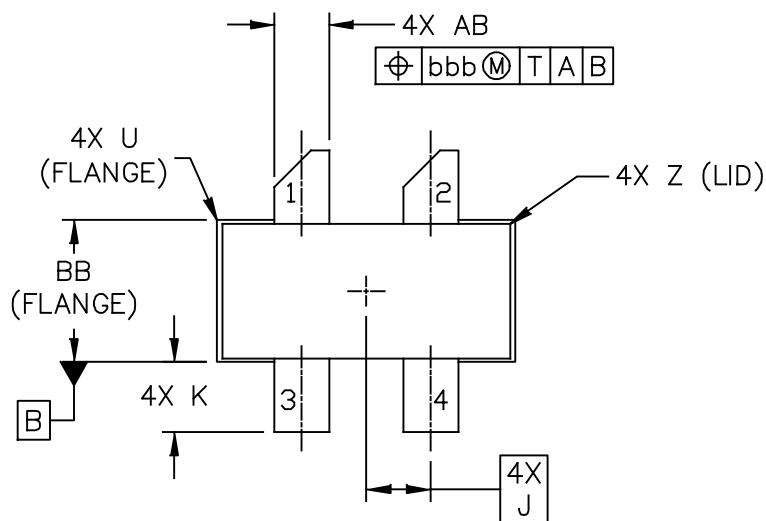

Figure 6. Series Equivalent Source and Load Impedance — 2400–2500 MHz

PRELIMINARY

PACKAGE DIMENSIONS



© NXP SEMICONDUCTORS N.V. ALL RIGHTS RESERVED	MECHANICAL OUTLINE	PRINT VERSION NOT TO SCALE
TITLE: NI-780S-4L	DOCUMENT NO: 98ASA10718D	REV: C
	STANDARD: NON-JEDEC	
	SOT1826-1	01 AUG 2016

NOTES:

1. DIMENSIONING AND TOLERANCING PER ANSI Y14.5M-1994.
2. CONTROLLING DIMENSION: INCH.
3. DELETED
4. DIMENSION H IS MEASURED .030 (0.762) AWAY FROM FLANGE TO CLEAR EPOXY FLOW OUT PARALLEL TO DATUM B.

DIM	INCH		MILLIMETER		DIM	INCH		MILLIMETER	
	MIN	MAX	MIN	MAX		MIN	MAX	MIN	MAX
AA	.805	.815	20.45	20.70	U		.040		1.02
BB	.382	.388	9.70	9.86	Z		.030		0.76
CC	.125	.170	3.18	4.32	AB	.145	.155	3.68	- 3.94
E	.035	.045	0.89	1.14					
F	.003	.006	0.08	0.15	aaa		.005		0.127
H	.057	.067	1.45	1.70	bbb		.010		0.254
J	.175 BSC		4.44 BSC		ccc		.015		0.381
K	.170	.210	4.32	5.33					
M	.774	.786	19.61	20.02					
N	.772	.788	19.61	20.02					
R	.365	.375	9.27	9.53					
S	.365	.375	9.27	9.52					
© NXP SEMICONDUCTORS N. V. ALL RIGHTS RESERVED			MECHANICAL OUTLINE			PRINT VERSION NOT TO SCALE			
TITLE:					DOCUMENT NO: 98ASA10718D		REV: C		
NI-780S-4L					STANDARD: NON-JEDEC				
					SOT1826-1		01 AUG 2016		

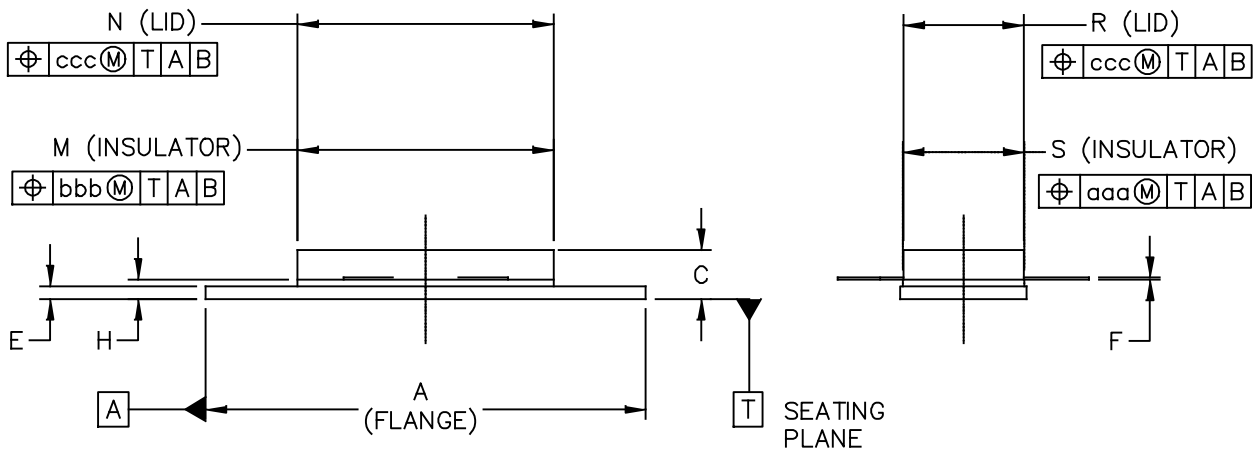
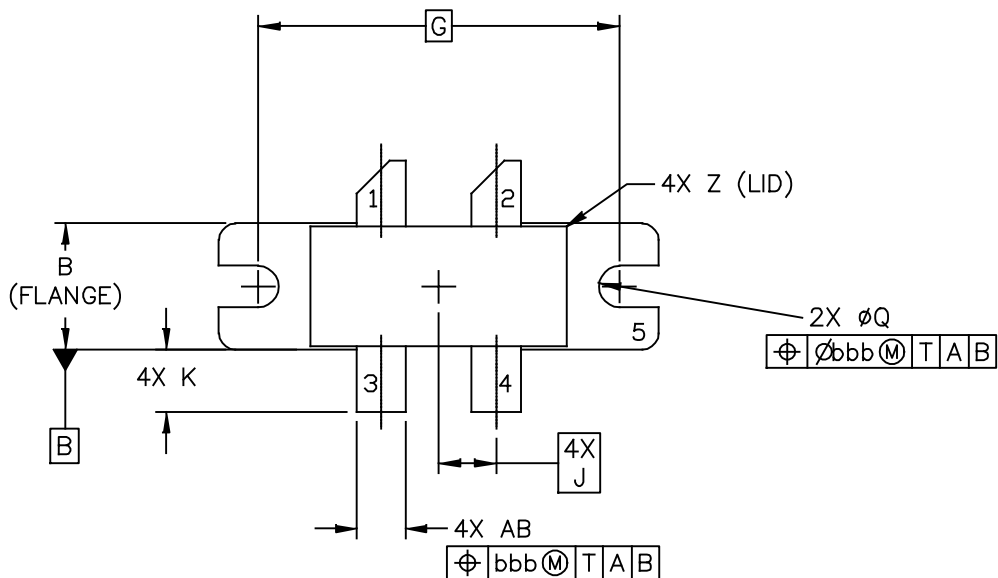

© NXP SEMICONDUCTORS N.V. ALL RIGHTS RESERVED	MECHANICAL OUTLINE	PRINT VERSION NOT TO SCALE
TITLE: NI 780-4	DOCUMENT NO: 98ASA10793D	REV: A
	STANDARD: NON-JEDEC	
	SOT1827-1	17 MAR 2016

NOTES:

1. DIMENSIONING AND TOLERANCING PER ANSI Y14.5M-1994.
2. CONTROLLING DIMENSION: INCH.
3. DIMENSION H IS MEASURED .030 (0.762) AWAY FROM PACKAGE BODY.

STYLE 1:

- PIN 1. DRAIN
 2. DRAIN
 3. GATE
 4. GATE
 5. SOURCE

DIM	INCH		MILLIMETER		DIM	INCH		MILLIMETER	
	MIN	MAX	MIN	MAX		MIN	MAX	MIN	MAX
A	1.335	1.345	33.91	34.16	R	.365	.375	9.27	9.53
B	.380	.390	9.65	9.91	S	.365	.375	9.27	9.52
C	.125	.170	3.18	4.32	U		.040		1.02
E	.035	.045	0.89	1.14	Z		.030		0.76
F	.003	.006	0.08	0.15	AB	.145	.155	3.68	3.94
G	1.100 BSC		27.94 BSC						
H	.057	.067	1.45	1.7	aaa		.005		0.127
J	.175 BSC		4.44 BSC		bbb		.010		0.254
K	.170	.210	4.32	5.33	ccc		.015		0.381
M	.774	.786	19.61	20.02					
N	.772	.788	19.61	20.02					
Q	∅.118	∅.138	∅3	∅3.51					
© NXP SEMICONDUCTORS N. V. ALL RIGHTS RESERVED			MECHANICAL OUTLINE			PRINT VERSION NOT TO SCALE			
TITLE: NI 780-4					DOCUMENT NO: 98ASA10793D REV: A				
					STANDARD: NON-JEDEC				
					SOT1827-1			17 MAR 2016	

How to Reach Us:

Home Page:
nxp.com

Web Support:
nxp.com/support

Information in this document is provided solely to enable system and software implementers to use NXP products. There are no express or implied copyright licenses granted hereunder to design or fabricate any integrated circuits based on the information in this document. NXP reserves the right to make changes without further notice to any products herein.

NXP makes no warranty, representation, or guarantee regarding the suitability of its products for any particular purpose, nor does NXP assume any liability arising out of the application or use of any product or circuit, and specifically disclaims any and all liability, including without limitation consequential or incidental damages. "Typical" parameters that may be provided in NXP data sheets and/or specifications can and do vary in different applications, and actual performance may vary over time. All operating parameters, including "typicals," must be validated for each customer application by customer's technical experts. NXP does not convey any license under its patent rights nor the rights of others. NXP sells products pursuant to standard terms and conditions of sale, which can be found at the following address: nxp.com/SalesTermsandConditions.

NXP and the NXP logo are trademarks of NXP B.V. All other product or service names are the property of their respective owners.

© 2019 NXP B.V.



Компания «ЭлектроПласт» предлагает заключение долгосрочных отношений при поставках импортных электронных компонентов на взаимовыгодных условиях!

Наши преимущества:

- Оперативные поставки широкого спектра электронных компонентов отечественного и импортного производства напрямую от производителей и с крупнейших мировых складов;
- Поставка более 17-ти миллионов наименований электронных компонентов;
- Поставка сложных, дефицитных, либо снятых с производства позиций;
- Оперативные сроки поставки под заказ (от 5 рабочих дней);
- Экспресс доставка в любую точку России;
- Техническая поддержка проекта, помощь в подборе аналогов, поставка прототипов;
- Система менеджмента качества сертифицирована по Международному стандарту ISO 9001;
- Лицензия ФСБ на осуществление работ с использованием сведений, составляющих государственную тайну;
- Поставка специализированных компонентов (Xilinx, Altera, Analog Devices, Intersil, Interpoint, Microsemi, Aeroflex, Peregrine, Syfer, Eurofarad, Texas Instrument, Miteq, Cobham, E2V, MA-COM, Hittite, Mini-Circuits, General Dynamics и др.);

Помимо этого, одним из направлений компании «ЭлектроПласт» является направление «Источники питания». Мы предлагаем Вам помощь Конструкторского отдела:

- Подбор оптимального решения, техническое обоснование при выборе компонента;
- Подбор аналогов;
- Консультации по применению компонента;
- Поставка образцов и прототипов;
- Техническая поддержка проекта;
- Защита от снятия компонента с производства.



Как с нами связаться

Телефон: 8 (812) 309 58 32 (многоканальный)

Факс: 8 (812) 320-02-42

Электронная почта: org@eplast1.ru

Адрес: 198099, г. Санкт-Петербург, ул. Калинина, дом 2, корпус 4, литера А.