



*K Series - Page K4*



*KCB Series - Page K5*



*KE Series - Page K6*



*KLNS Series - Page K8*



*KN Series - Page K8*



*PK Series - Page K13*



*PKD Series - Page K14*



**Alcoknob Part Number Index**

K1250A1/4 .....K4  
 K1250B1/4 .....K4  
 K1251B1/4 .....K4  
 K1255AS1/4 .....K4  
 K1255BS1/4 .....K4  
 K500A1/4 .....K4  
 K500A1/8 .....K4  
 K500B1/4 .....K4  
 K500B1/8 .....K4  
 K700A1/4 .....K4  
 K700B1/4 .....K4  
 K900A1/4 .....K4  
 K900B1/4 .....K4  
 KA1250A1/4 .....K4  
 KA1250B1/4 .....K4  
 KA500A1/4 .....K4  
 KA500A1/8 .....K4  
 KA500B1/4 .....K4  
 KA500B1/8 .....K4  
 KA700A1/4 .....K4  
 KA700B1/4 .....K4  
 KA900A1/4 .....K4  
 KA900B1/4 .....K4  
 KAS500A1/4 .....K4  
 KAS500A1/8 .....K4  
 KAS500B1/4 .....K4  
 KAS500B1/8 .....K4  
 KAS700A1/4 .....K4  
 KAS700B1/4 .....K4  
 KAS900A1/4 .....K4  
 KAS900B1/4 .....K4  
 KB500A1/4 .....K5  
 KB500B1/4 .....K5  
 KB500B1/8 .....K5  
 KB700A1/4 .....K5  
 KB700B1/4 .....K5  
 KB900A1/4 .....K5  
 KB900B1/4 .....K5  
 KBS500A1/8 .....K5  
 KBS500A101/4 .....K5  
 KBS500A101/8 .....K5  
 KBS500B1/4 .....K5  
 KBS500B1/8 .....K5  
 KBS500B101/4 .....K5  
 KBS500B101/8 .....K5  
 KCB500A1/4 .....K5  
 KCB500A1/8 .....K5  
 KCB500B1/4 .....K5  
 KCB500B1/8 .....K5  
 KCB600A1/4 .....K5  
 KCB600A1/8 .....K5  
 KCB600B1/4 .....K5  
 KCB600B1/8 .....K5  
 KCB700A1/4 .....K5  
 KCB700B1/4 .....K5  
 KCB900A1/4 .....K5  
 KCB900B1/4 .....K5  
 KD1250A1/4 .....K6  
 KD1250B1/4 .....K6  
 KD500A1/4 .....K6  
 KD500A1/8 .....K6  
 KD500B1/4 .....K6  
 KD500B1/8 .....K6  
 KD700A1/4 .....K6  
 KD700B1/4 .....K6  
 KD900A1/4 .....K6  
 KD900B1/4 .....K6  
 KE1250AB1/4 .....K6  
 KE500AB1/4 .....K6  
 KE500AB1/8 .....K6  
 KE700AB1/4 .....K6  
 KE900AB1/4 .....K6

KES500AB1/4 .....K6  
 KES500AB1/8 .....K6  
 KES700AB1/4 .....K6  
 KES900AB1/4 .....K6  
 KFS400B1/8 .....K7  
 KFS500B1/4 .....K7  
 KFS500B1/8 .....K7  
 KFS600B1/4 .....K7  
 KHF1250A1/4 .....K7  
 KHF500A1/4 .....K7  
 KHF700A1/4 .....K7  
 KHF900A1/4 .....K7  
 KLN1250A1/4 .....K7  
 KLN1250B1/4 .....K7  
 KLN500A1/4 .....K7  
 KLN500A1/8 .....K7  
 KLN500B1/4 .....K7  
 KLN500B1/8 .....K7  
 KLN500S1/4 .....K7  
 KLN700A1/4 .....K7  
 KLN700B1/4 .....K7  
 KLN700B1/8 .....K7  
 KLN700S1/4 .....K7  
 KLN900A1/4 .....K7  
 KLN900B1/4 .....K7  
 KLN900S1/4 .....K7  
 KLN5500A1/4 .....K8  
 KLN5500A1/8 .....K8  
 KLN5500B1/4 .....K8  
 KLN5500B1/8 .....K8  
 KLN5700A1/4 .....K8  
 KLN5700B1/4 .....K8  
 KLN5900A1/4 .....K8  
 KLN5900B1/4 .....K8  
 KN1250A1/4 .....K9  
 KN1250AB1/4 .....K9  
 KN1250B1/4 .....K9  
 KN1250BA1/4 .....K9  
 KN1251A1/4 .....K9  
 KN1251B1/4 .....K9  
 KN1750A1/4 .....K8  
 KN1750B1/4 .....K8  
 KN1751A1/4 .....K8  
 KN1751AB1/4 .....K8  
 KN1751AS1/4 .....K8  
 KN1751B1/4 .....K8  
 KN1751BA1/4 .....K8  
 KN1751BS1/4 .....K8  
 KN1755ABS1/4 .....K9  
 KN1755AS1/4 .....K9  
 KN1755BAS1/4 .....K9  
 KN1755BS1/4 .....K9  
 KN500A1/4 .....K9  
 KN500A1/8 .....K9  
 KN500AB1/4 .....K9  
 KN500AB1/8 .....K9  
 KN500B1/4 .....K9  
 KN500B1/8 .....K9  
 KN500BA1/4 .....K9  
 KN500BA1/8 .....K9  
 KN501A1/4 .....K8  
 KN501A1/8 .....K8  
 KN501B1/4 .....K8  
 KN501B1/8 .....K8  
 KN501BA1/4 .....K8  
 KN501BA1/8 .....K8  
 KN5700A1/4 .....K9  
 KN5700B1/4 .....K9  
 KN700A1/4 .....K9  
 KN700AB1/4 .....K9  
 KN700B1/4 .....K9  
 KN700BA1/4 .....K9  
 KN701A1/4 .....K8  
 KN701B1/4 .....K8

KN701BA1/4 .....K8  
 KN701BA1/8 .....K8  
 KN900A1/4 .....K9  
 KN900AB1/4 .....K9  
 KN900B1/4 .....K9  
 KN900BA1/4 .....K9  
 KNS501A1/4 .....K10  
 KNS501A1/8 .....K10  
 KNS501B1/4 .....K10  
 KNS501B1/8 .....K10  
 KNS501BA1/4 .....K10  
 KNS501BA1/8 .....K10  
 KNS701A1/4 .....K10  
 KNS701B1/4 .....K10  
 KNS701BA1/4 .....K10  
 KNS701BA1/8 .....K10  
 KPN500A1/4 .....K10  
 KPN500A1/8 .....K10  
 KPN500B1/4 .....K10  
 KPN500B1/8 .....K10  
 KPN700A1/4 .....K10  
 KPN700B1/4 .....K10  
 KPN900A1/4 .....K10  
 KPN900B1/4 .....K10  
 KR1 .....K21  
 KR2 .....K21  
 KR3 .....K21  
 KS500A1/4 .....K10  
 KS500A1/8 .....K10  
 KS500B1/4 .....K10  
 KS500B1/8 .....K10  
 KS700A1/4 .....K10  
 KS700B1/4 .....K10  
 KS900A1/4 .....K10  
 KS900B1/4 .....K10  
 KT500A1/4 .....K11  
 KT500B1/4 .....K11  
 KT500B1/8 .....K11  
 KT700A1/4 .....K11  
 KT700B1/4 .....K11  
 KT900A1/4 .....K11  
 KT900B1/4 .....K11  
 KU401B1/8 .....K11  
 KU402B1/8 .....K11  
 KU500B1/4 .....K11  
 KU500B1/8 .....K11  
 KU700B1/4 .....K11  
 KUS402B1/8 .....K11  
 KUS500B1/4 .....K11  
 KUS500B1/8 .....K11  
 KUS700B1/4 .....K11  
 PH15181/4 .....K12  
 PK1100B1/8 .....K12  
 PK50B1/4 .....K12  
 PK50B1/8 .....K12  
 PK70B1/4 .....K12  
 PK90B1/4 .....K12  
 PKA50B1/4 .....K13  
 PKA50B1/8 .....K13  
 PKA55B1/4 .....K13  
 PKA55B1/8 .....K13  
 PKA70B1/4 .....K13  
 PKA90B1/4 .....K13  
 PKAP50B1/4 .....K13  
 PKAP50B1/8 .....K13  
 PKAP70B1/4 .....K13  
 PKB70B1/4 .....K14  
 PKB90B1/4 .....K14  
 PKD100B1/4 .....K14  
 PKD100B101/4 .....K14  
 PKD60B1/4 .....K14  
 PKD60B1/8 .....K14  
 PKD60B101/4 .....K14  
 PKD60B101/8 .....K14

PKD70B1/4 .....K14  
 PKD70B101/4 .....K14  
 PKDT100B1/4 .....K15  
 PKDT100B101/4 .....K15  
 PKDT60B101/8 .....K15  
 PKDT70B1/4 .....K15  
 PKDT70B101/4 .....K15  
 PKE60B1/4 .....K15  
 PKE60B1/8 .....K15  
 PKE90B1/4 .....K15  
 PKES120B1/4 .....K15  
 PKES140B1/4 .....K15  
 PKES150B1/4 .....K15  
 PKES60B1/4 .....K15  
 PKES60B1/8 .....K15  
 PKES70B1/4 .....K15  
 PKES90B1/4 .....K15  
 PKF50B1/8 .....K16  
 PKG100B1/4 .....K17  
 PKG1255B1/4 .....K17  
 PKG40B1/8 .....K16  
 PKG50B1/4 .....K16  
 PKG50B1/8 .....K16  
 PKG60B1/4 .....K17  
 PKG60B1/8 .....K17  
 PKG70B1/4 .....K17  
 PKG70B1/8 .....K17  
 PKG90B1/4 .....K17  
 PKG90B1/8 .....K17  
 PKGP100B1/4 .....K17  
 PKGP70B1/4 .....K17  
 PKGP90B1/4 .....K17  
 PKJ50B1/4 .....K17  
 PKJ50B1/8 .....K17  
 PKJ60B1/4 .....K17  
 PKJ70B1/4 .....K17  
 PKJT50B1/4 .....K18  
 PKJT50B1/8 .....K18  
 PKJT60B1/4 .....K18  
 PKJT70B1/4 .....K18  
 PKN60B1/4 .....K18  
 PKN60B1/8 .....K18  
 PKN70B1/4 .....K18  
 PKN90B1/4 .....K18  
 PKNT60B1/4 .....K18  
 PKNT70B1/4 .....K18  
 PKNT90B1/4 .....K18  
 PKS1103B101/4 .....K18  
 PKS1104B1/4 .....K19  
 PKS1105B101/4 .....K19  
 PKS1106B1/4 .....K19  
 PKS1132B1/4 .....K19  
 PKS1132B101/4 .....K19  
 PKS1132B51/4 .....K19  
 PKS1132B91/4 .....K19  
 PKS90B1/4 .....K20  
 PKS90B101/4 .....K20  
 PKX100B1/4 .....K20  
 PKX110B1/4 .....K20  
 PKX130B1/4 .....K20  
 PKX50B1/4 .....K20  
 PKX50B1/8 .....K20  
 PKX60B1/4 .....K20  
 PKX60B1/8 .....K20

**K**  
Alcoknob

**General Knob Information****SPECIFICATIONS****A. STANDARD KNOB TYPES**

1. **INSPECTION CRITERIA** - Normal inspection is performed without magnification while holding knob at a distance of 12 to 14 inches for a period of 5 seconds, under normal light. The following imperfections are not acceptable:
  - Finish: visible marks or scratches, runs, or non-uniform coverage.
  - Artwork: voids, specks, bleeding or other inconsistencies
2. **MATERIALS** -
  - K Series: Machined aluminum alloy stock  
Finish: gloss anodize  
Setscrews: Stainless steel, type 303, hex head, cup point
  - P Series: General purpose phenolic (thermoset) (Max. Temp. 120-125°C continuous)  
Finish: Gloss (except PKX, matte)  
Insert: Brass  
Setscrews: Stainless steel, hex head, cup point  
Inlays: Skirts: Aluminum alloy, spun finish

**B. CUSTOM TYPES**

1. **ALUMINUM**
  - Configuration - most semi-standard or custom designs can be machined. A drawing is required to provide a quotation. Non-standard shaft hole diameters are available also.
  - Finish - Anodizing or paint of various colors can be provided. A color chip is required to ensure proper color shade.
  - Artwork - alpha-numeric lettering, indicator lines, markings, etc. can be provided. Silkscreening and other processes are available.
2. **PHENOLIC**
  - Configuration - most custom styles can be molded.
  - Colors - various custom colored standard knobs can be provided. Color chip is required.
  - Artwork - lettering, markings, etc. can be provided.

**Knobs, Machined Aluminum**

**K SERIES**



K700B1/4



Tyco 3 Flute Design with and without Indicator Line									
Electronics	Alcoswitch	Color	A	B	C	D	E	F	G
1437621-7	K500A1/8	Natural	.500(12.7)	.430(10.9)	.374(9.50)	.430(10.9)	.625(15.9)	.429(10.9)	.512(13.0)
1437621-6	K500A1/4	Natural	.500(12.7)	.430(10.9)	.374(9.50)	.430(10.9)	.625(15.9)	.429(10.9)	.512(13.0)
1437621-9	K500B1/8	Black	.500(12.7)	.430(10.9)	.374(9.50)	.430(10.9)	.625(15.9)	.429(10.9)	.512(13.0)
1437621-8	K500B1/4	Black	.500(12.7)	.430(10.9)	.374(9.50)	.430(10.9)	.625(15.9)	.429(10.9)	.512(13.0)
1-1437621-0	K700A1/4	Natural	.740(18.8)	.655(16.6)	.591(15.0)	.655(16.6)	.625(15.9)	.429(10.9)	.512(13.0)
1-1437621-1	K700B1/4	Black	.740(18.8)	.655(16.6)	.591(15.0)	.655(16.6)	.625(15.9)	.429(10.9)	.512(13.0)
1-1437621-3	K900A1/4	Natural	.937(23.8)	.817(20.8)	.709(18.0)	.817(20.8)	.625(15.9)	.429(10.9)	.512(13.0)
1-1437621-4	K900B1/4	Black	.937(23.8)	.817(20.8)	.709(18.0)	.817(20.8)	.625(15.9)	.429(10.9)	.512(13.0)
1437621-2	K1250A1/4	Natural	1.25(31.8)	1.11(28.2)	.984(25.0)	1.11(28.2)	.750(19.1)	.554(14.1)	.630(16.0)
1437621-3	K1250B1/4	Black	1.25(31.8)	1.11(28.2)	.984(25.0)	1.11(28.2)	.750(19.1)	.554(14.1)	.630(16.0)
Less Indicator									
1437621-4	K1251B1/4	Black	1.25(31.8)	1.11(28.2)	.984(25.0)	1.11(28.2)	.750(19.1)	.554(14.1)	.630(16.0)
With Crank Spinner + Less Indicator									
	K1255A1/4	Natural	1.25(21.8)	1.11(28.2)	.984(25.0)	1.11(28.2)	.750(19.1)	.554(14.1)	.630(16.0)
1437621-5	K1255B1/4	Black	1.25(31.8)	1.11(28.2)	.984(25.0)	1.11(28.2)	.750(19.1)	.554(14.1)	.630(16.0)

**KA SERIES**



KA500A1/4



KA700B1/4



Tyco 6 Flute Design with Indicator Line									
Electronics	Alcoswitch	Color	A	B	C	D	E	F	G
2-1437621-0	KA500A1/8	Natural	.500(12.7)	.430(10.9)	.375(9.53)	.430(10.9)	.625(15.9)	.512(13.0)	.430(10.9)
1-1437621-9	KA500A1/4	Natural	.500(12.7)	.430(10.9)	.375(9.53)	.430(10.9)	.625(15.9)	.512(13.0)	.430(10.9)
2-1437621-2	KA500B1/8	Black	.500(12.7)	.430(10.9)	.375(9.53)	.430(10.9)	.625(15.9)	.512(13.0)	.430(10.9)
2-1437621-1	KA500B1/4	Black	.500(12.7)	.430(10.9)	.375(9.53)	.430(10.9)	.625(15.9)	.512(13.0)	.430(10.9)
2-1437621-3	KA700A1/4	Natural	.750(19.1)	.655(16.6)	.590(15.0)	.655(16.6)	.625(15.9)	.512(13.0)	.430(10.9)
2-1437621-4	KA700B1/4	Black	.750(19.1)	.655(16.6)	.590(15.0)	.655(16.6)	.625(15.9)	.512(13.0)	.430(10.9)
2-1437621-5	KA900A1/4	Natural	.937(23.8)	.817(20.8)	.700(17.8)	.817(20.8)	.625(15.9)	.512(13.0)	.430(10.9)
2-1437621-6	KA900B1/4	Black	.937(23.8)	.817(20.8)	.700(17.8)	.817(20.8)	.625(15.9)	.512(13.0)	.430(10.9)
	KA1250A1/4	Natural	1.25(31.8)	1.11(28.2)	.985(25.0)	1.11(28.2)	.750(19.1)	.630(16.0)	.554(14.1)
1-1437621-8	KA1250B1/4	Black	1.25(31.8)	1.11(28.2)	.985(25.0)	1.11(28.2)	.750(19.1)	.630(16.0)	.554(14.1)

**KAS SERIES**



Tyco 6 Flute Design with Aluminum Skirt and Indicator Lines									
Electronics	Alcoswitch	Color	A	B	C	D	E	F	G
2-1437621-8	KAS500A1/8	Natural	.500(12.7)	.430(10.9)	.380(9.65)	.740(18.8)	.630(16.0)	.510(13.0)	.430(10.9)
2-1437621-7	KAS500A1/4	Natural	.500(12.7)	.430(10.9)	.380(9.65)	.740(18.8)	.630(16.0)	.510(13.0)	.430(10.9)
3-1437621-0	KAS500B1/8	Black	.500(12.7)	.430(10.9)	.380(9.65)	.740(18.8)	.630(16.0)	.510(13.0)	.430(10.9)
2-1437621-9	KAS500B1/4	Black	.500(12.7)	.430(10.9)	.380(9.65)	.740(18.8)	.630(16.0)	.510(13.0)	.430(10.9)
3-1437621-1	KAS700A1/4	Natural	.750(19.1)	.650(16.5)	.590(15.0)	1.14(29.0)	.630(16.0)	.510(13.0)	.430(10.9)
3-1437621-2	KAS700B1/4	Black	.750(19.1)	.650(16.5)	.590(15.0)	1.14(29.0)	.630(16.0)	.510(13.0)	.430(10.9)
3-1437621-3	KAS900A1/4	Natural	.940(23.9)	.820(20.8)	.710(18.0)	1.40(35.6)	.630(16.0)	.510(13.0)	.430(10.9)
3-1437621-4	KAS900B1/4	Black	.940(23.9)	.820(20.8)	.710(18.0)	1.40(35.6)	.630(16.0)	.510(13.0)	.430(10.9)

**Knobs, Machined Aluminum**



**KB SERIES**



KB500A1/4



KB900B1/4

Tyco		Control Knob with Straight Knurl and Top Line Indicator							
Electronics	Alcoswitch	Color	A	B	C	D	E	F	G
3-1437621-6	KB500A1/8	Natural	.500(12.7)	.433(11.0)	.394(10.0)	.472(12.0)	.787(20.0)	.630(16.0)	.610(15.5)
3-1437621-5	KB500A1/4	Natural	.500(12.7)	.433(11.0)	.394(10.0)	.472(12.0)	.787(20.0)	.630(16.0)	.610(15.5)
3-1437621-9	KB500B1/8	Black	.500(12.7)	.433(11.0)	.394(10.0)	.472(12.0)	.787(20.0)	.630(16.0)	.610(15.5)
3-1437621-8	KB500B1/4	Black	.500(12.7)	.433(11.0)	.394(10.0)	.472(12.0)	.787(20.0)	.630(16.0)	.610(15.5)
4-1437621-0	KB700A1/4	Natural	.750(19.0)	.673(17.1)	.581(15.0)	.705(17.9)	.787(20.0)	.630(16.0)	.610(15.5)
4-1437621-2	KB700B1/4	Black	.750(19.0)	.673(17.1)	.581(15.0)	.705(17.9)	.787(20.0)	.630(16.0)	.610(15.5)
4-1437621-4	KB900A1/4	Natural	.930(23.6)	.866(22.0)	.710(18.0)	.902(22.9)	.787(20.0)	.630(16.0)	.610(15.5)
4-1437621-5	KB900B1/4	Black	.930(23.6)	.866(22.0)	.710(18.0)	.902(22.9)	.787(20.0)	.630(16.0)	.610(15.5)



**KBS SERIES**



KBS500A101/4

Tyco		Control Knob with Straight Knurl and Skirt							
Electronics	Alcoswitch	Color	A	B	C	D	E	F	G
<b>With 0-9 Numerals (36°)</b>									
4-1437621-9	KBS500A101/8	Natural	.500(12.7)	.433(11.0)	.708(18.0)	1.00(25.4)	.950(24.1)	.826(21.0)	.655(16.7)
	KBS500A101/4	Natural	.500(12.7)	.433(11.0)	.708(18.0)	1.00(25.4)	.950(24.1)	.826(21.0)	.655(16.7)
5-1437621-3	KBS500B101/8	Black	.500(12.7)	.433(11.0)	.708(18.0)	1.00(25.4)	.950(24.1)	.826(21.0)	.655(16.7)
5-1437621-2	KBS500B101/4	Black	.500(12.7)	.433(11.0)	.708(18.0)	1.00(25.4)	.950(24.1)	.826(21.0)	.655(16.7)
<b>With Indicator Line</b>									
4-1437621-8	KBS500A1/8	Natural	.500(12.7)	.433(11.0)	.708(18.0)	1.00(25.4)	.950(24.1)	.826(21.0)	.655(16.7)
4-1437621-7	KBS500A1/4	Natural	.500(12.7)	.433(11.0)	.708(18.0)	1.00(25.4)	.950(24.1)	.826(21.0)	.655(16.7)
5-1437621-1	KBS500B1/8	Black	.500(12.7)	.433(11.0)	.708(18.0)	1.00(25.4)	.950(24.1)	.826(21.0)	.655(16.7)
5-1437621-0	KBS500B1/4	Black	.500(12.7)	.433(11.0)	.708(18.0)	1.00(25.4)	.950(24.1)	.826(21.0)	.655(16.7)



**KCB SERIES**



KCB500A1/4



KCB700B1/4

Tyco		Control Knob with Sawcut Indicator							
Electronics	Alcoswitch	Color	A	B	C	D	E	F	G
5-1437621-7	KCB500A1/8	Natural	.500(12.7)	.197(5.08)	.374(9.50)	.126(3.20)	.118(3.00)	.335(8.51)	.750(19.1)
5-1437621-6	KCB500A1/4	Natural	.500(12.7)	.197(5.08)	.374(9.50)	.126(3.20)	.118(3.00)	.335(8.51)	.750(19.1)
5-1437621-9	KCB500B1/8	Black	.500(12.7)	.197(5.08)	.374(9.50)	.126(3.20)	.118(3.00)	.335(8.51)	.750(19.1)
5-1437621-8	KCB500B1/4	Black	.500(12.7)	.197(5.08)	.374(9.50)	.126(3.20)	.118(3.00)	.335(8.51)	.750(19.1)
6-1437621-0	KCB600A1/8	Natural	.618(15.7)	.197(5.08)	.394(10.0)	.126(3.20)	.118(3.00)	.335(8.51)	.750(19.1)
	KCB600A1/4	Natural	.618(15.7)	.197(5.08)	.394(10.0)	.126(3.20)	.118(3.00)	.335(8.51)	.750(19.1)
6-1437621-2	KCB600B1/8	Black	.618(15.7)	.197(5.08)	.394(10.0)	.126(3.20)	.118(3.00)	.335(8.51)	.750(19.1)
6-1437621-1	KCB600B1/4	Black	.618(15.7)	.197(5.08)	.394(10.0)	.126(3.20)	.118(3.00)	.335(8.51)	.750(19.1)
6-1437621-3	KCB700A1/4	Natural	.746(18.8)	.197(5.08)	.512(13.0)	.250(6.35)	.118(3.00)	.335(8.51)	.898(22.8)
6-1437621-4	KCB700B1/4	Black	.746(18.8)	.197(5.08)	.512(13.0)	.250(6.35)	.118(3.00)	.335(8.51)	.898(22.8)
6-1437621-5	KCB900A1/4	Natural	.937(23.8)	.197(5.08)	.709(18.0)	.250(6.35)	.118(3.00)	.335(8.51)	.898(22.8)
6-1437621-7	KCB900B1/4	Black	.937(23.8)	.197(5.08)	.709(18.0)	.250(6.35)	.118(3.00)	.335(8.51)	.898(22.8)

**Knobs, Machined Aluminum**

**KD SERIES**



KD1250B1/4



Tyco Diamond Knurl with Indicator Line									
Electronics	Alcoswitch	Color	A	B	C	D	E	F	G
7-1437621-1	KD500A1/8	Natural	.500(12.7)	.430(10.9)	.380(9.65)	.430(10.9)	.630(16.0)	.510(13.0)	.470(11.9)
7-1437621-0	KD500A1/4	Natural	.500(12.7)	.430(10.9)	.380(9.65)	.430(10.9)	.630(16.0)	.510(13.0)	.470(11.9)
7-1437621-3	KD500B1/8	Black	.500(12.7)	.430(10.9)	.380(9.65)	.430(10.9)	.630(16.0)	.510(13.0)	.470(11.9)
7-1437621-2	KD500B1/4	Black	.500(12.7)	.430(10.9)	.380(9.65)	.430(10.9)	.630(16.0)	.510(13.0)	.470(11.9)
7-1437621-4	KD700A1/4	Natural	.750(19.1)	.660(16.8)	.590(15.0)	.660(16.8)	.630(16.0)	.510(13.0)	.470(11.9)
7-1437621-5	KD700B1/4	Black	.750(19.1)	.660(16.8)	.590(15.0)	.660(16.8)	.630(16.0)	.510(13.0)	.470(11.9)
7-1437621-6	KD900A1/4	Natural	.940(23.9)	.820(20.8)	.710(18.0)	.820(20.8)	.630(16.0)	.510(13.0)	.470(11.9)
7-1437621-7	KD900B1/4	Black	.940(23.9)	.820(20.8)	.710(18.0)	.820(20.8)	.630(16.0)	.510(13.0)	.470(11.9)
6-1437621-8	KD1250A1/4	Natural	1.25(31.8)	1.11(28.2)	.980(24.9)	1.11(28.2)	.750(19.1)	.630(16.0)	.590(15.0)
6-1437621-9	KD1250B1/4	Black	1.25(31.8)	1.11(28.2)	.980(24.9)	1.11(28.2)	.750(19.1)	.630(16.0)	.590(15.0)

**KE SERIES**



KE900AB1/4



KE500AB1/4

Tyco Knurl Grip with Top Dot Indicator									
Electronics	Alcoswitch	Color	A	B	C	D	E	F	
8-1437621-0	KE500AB1/8	Ntl. - Blk.	.500(12.7)	.126(3.20)	.382(9.70)	.460(11.7)	.625(15.9)	.512(13.0)	
7-1437621-9	KE500AB1/4	Ntl. - Blk.	.500(12.7)	.126(3.20)	.382(9.70)	.460(11.7)	.625(15.9)	.512(13.0)	
8-1437621-1	KE700AB1/4	Ntl. - Blk.	.740(18.8)	.251(6.38)	.630(16.0)	.708(18.0)	.625(15.9)	.512(13.0)	
8-1437621-2	KE900AB1/4	Ntl. - Blk.	.93(23.8)	.251(6.38)	.787(20.0)	.900(22.9)	.625(15.9)	.512(13.0)	
7-1437621-8	KE1250AB1/4	Ntl. - Blk.	1.25(31.8)	.251(6.38)	1.06(26.9)	1.17(29.7)	.625(15.9)	.512(13.0)	

**KES SERIES**



KES500AB1/4



Tyco Knurl Grip with Dot Indicator on Skirt									
Electronics	Alcoswitch	Color	A	B	C	D	E	F	
8-1437621-4	KES500AB1/8	Ntl. - Blk.	.500(12.7)	.460(11.7)	.382(9.70)	.750(19.1)	.625(15.9)	.512(13.0)	
8-1437621-3	KES500AB1/4	Ntl. - Blk.	.500(12.7)	.460(11.7)	.382(9.70)	.750(19.1)	.625(15.9)	.512(13.0)	
8-1437621-5	KES700AB1/4	Ntl. - Blk.	.750(19.1)	.710(18.1)	.630(16.0)	1.13(28.7)	.625(15.9)	.512(13.0)	
	KES900AB1/4	Ntl. - Blk.	.937(23.8)	.897(22.8)	.787(20.0)	1.44(36.6)	.625(15.9)	.512(13.0)	

**K**

**K Series**

**Knobs, Machined Aluminum**

**KFS SERIES**



KFS400B1/8

Tyco			Straight Knurl with Indicator on Skirt						
Electronics	Alcoswitch	Color	A	B	C	D	E	F	G
8-1437621-6	KFS400B1/8	Black Matte	.380(9.65)	.382(9.70)	.256(6.50)	.500(12.7)	.098(2.49)	.469(11.9)	.591(15.0)
8-1437621-8	KFS500B1/8	Black Matte	.500(12.7)	.382(9.70)	.252(6.48)	.630(16.0)	.161(4.09)	.469(11.9)	.630(16.0)
8-1437621-7	KFS500B1/4	Black Matte	.618(15.7)	.280(7.11)	.382(9.70)	1.00(25.4)	.161(4.09)	.630(16.0)	0.811(20.6)
8-1437621-9	KFS600B1/4	Black Matte	.618(15.7)	.280(7.11)	.382(9.70)	1.00(25.4)	.161(4.09)	.630(16.0)	0.811(20.6)

**KHF SERIES**



KHF500A1/4



KHF900A1/4

Tyco			Plain Body with Top and Side Sawcut Indicator				
Electronics	Alcoswitch	Color	A	B	C	D	E
9-1437621-1	KHF500A1/4	Natural	.500(12.7)	.374(9.50)	.118(3.00)	.342(8.69)	.563(14.3)
9-1437621-2	KHF700A1/4	Natural	.740(18.8)	.590(15.0)	.118(3.00)	.592(15.0)	.563(14.3)
9-1437621-3	KHF900A1/4	Natural	.937(23.8)	.708(18.0)	.118(3.00)	.779(19.8)	.563(14.3)
*9-1437621-0	KHF1250A1/4	Natural	1.23(31.8)	.984(25.0)	.118(3.00)	1.08(27.5)	.563(14.3)

**KLN SERIES**

Tyco			Straight Knurl with Top and Side Indicator						
Electronics	Alcoswitch	Color	A	B	C	D	E	F	G
9-1437621-7	KLN500A1/8	Natural	.500(12.7)	0.445(11.3)	.374(9.50)	.281(7.14)	.625(15.9)	.512(13.0)	.527(13.4)
9-1437621-6	KLN500A1/4	Natural	.500(12.7)	0.445(11.3)	.374(9.50)	.281(7.14)	.625(15.9)	.512(13.0)	.527(13.4)
9-1437621-9	KLN500B1/8	Black	.500(12.7)	0.445(11.3)	.374(9.50)	.281(7.14)	.625(15.9)	.512(13.0)	.527(13.4)
9-1437621-8	KLN500B1/4	Black	.500(12.7)	0.445(11.3)	.374(9.50)	.281(7.14)	.625(15.9)	.512(13.0)	.527(13.4)
1437622-1	KLN500S1/4	Smoke	.500(12.7)	0.445(11.3)	.374(9.50)	.281(7.14)	.625(15.9)	.512(13.0)	.527(13.4)
1437622-2	KLN700A1/4	Natural	.740(18.8)	.685(17.4)	.591(15.0)	.281(7.14)	.625(15.9)	.512(13.0)	.527(13.4)
1437622-3	KLN700B1/4	Black	.740(18.8)	.685(17.4)	.591(15.0)	.281(7.14)	.625(15.9)	.512(13.0)	.527(13.4)
1437622-4	KLN700B1/8	Black	.740(18.8)	.685(17.4)	.591(15.0)	.281(7.14)	.625(15.9)	.512(13.0)	.527(13.4)
1437622-5	KLN700S1/4	Smoke	.740(18.8)	.685(17.4)	.591(15.0)	.281(7.14)	.625(15.9)	.512(13.0)	.527(13.4)
1437622-6	KLN900A1/4	Natural	.937(23.8)	.882(22.4)	0.709(18.0)	.281(7.14)	.625(15.9)	.512(13.0)	.527(13.4)
1437622-7	KLN900B1/4	Black	.937(23.8)	.882(22.4)	0.709(18.0)	.281(7.14)	.625(15.9)	.512(13.0)	.527(13.4)
1437622-8	KLN900S1/4	Smoke	.937(23.8)	.882(22.4)	0.709(18.0)	.281(7.14)	.625(15.9)	.512(13.0)	.527(13.4)
9-1437621-4	KLN1250A1/4	Natural	1.252(31.80)	1.195(30.35)	.984(25.0)	.281(7.14)	.625(15.9)	.512(13.0)	.527(13.4)
9-1437621-5	KLN1250B1/4	Black	1.252(31.80)	1.195(30.35)	.984(25.0)	.281(7.14)	.625(15.9)	.512(13.0)	.527(13.4)



KLN500A1/4

**Knobs, Machined Aluminum**

**KLNS SERIES**



KLNS500B1/8



KLNS900B1/4



Tyco Straight Knurl with Indicator Line on Top, Side and Skirt								
Electronics	Alcoswitch	Color	A	B	C	D	E	G
1-1437622-6	KLNS500A1/8	Natural	.500(12.7)	.280(7.11)	.380(9.65)	.750(19.0)	.160(4.07)	.630(16.0)
1-1437622-5	KLNS500A1/4	Natural	.500(12.7)	.280(7.11)	.380(9.65)	.750(19.0)	.160(4.07)	.630(16.0)
1-1437622-8	KLNS500B1/8	Black	.500(12.7)	.280(7.11)	.380(9.65)	.750(19.0)	.160(4.07)	.630(16.0)
1-1437622-7	KLNS500B1/4	Black	.500(12.7)	.280(7.11)	.380(9.65)	.750(19.0)	.160(4.07)	.630(16.0)
2-1437622-0	KLNS700A1/4	Natural	.750(19.0)	.280(7.11)	.590(14.9)	1.13(28.7)	.160(4.07)	.630(16.0)
2-1437622-1	KLNS700B1/4	Black	.750(19.0)	.280(7.11)	.590(14.9)	1.13(28.7)	.160(4.07)	.630(16.0)
2-1437622-2	KLNS900A1/4	Natural	.940(23.9)	.280(7.11)	.710(18.0)	1.40(35.5)	.160(4.07)	.630(16.0)
2-1437622-3	KLNS900B1/4	Black	.940(23.9)	.280(7.11)	.710(18.0)	1.40(35.5)	.160(4.07)	.630(16.0)

**KN SERIES**



KN501A1/4



NO. 6-32 SET SCREW 2 PLACES  
1/8" SHAFT=.126" (3.20)  
1/4" SHAFT=.251" (6.38)



ARROW INDICATOR

Tyco Straight Knurl with Arrowhead Indicator								
Electronics	Alcoswitch	Color	A	B	C	D	E	G
5-1437622-1	KN501A1/8	Natural	.500(12.7)	.445(11.3)	.374(9.50)	.445(11.3)	.625(15.9)	.512(13.0)
5-1437622-0	KN501A1/4	Natural	.500(12.7)	.445(11.3)	.374(9.50)	.445(11.3)	.625(15.9)	.512(13.0)
5-1437622-3	KN501B1/8	Black	.500(12.7)	.445(11.3)	.374(9.50)	.445(11.3)	.625(15.9)	.512(13.0)
5-1437622-2	KN501B1/4	Black	.500(12.7)	.445(11.3)	.374(9.50)	.445(11.3)	.625(15.9)	.512(13.0)
6-1437622-2	KN701A1/4	Natural	.750(19.1)	.695(17.7)	.590(15.0)	.695(17.7)	.625(15.9)	.512(13.0)
6-1437622-3	KN701B1/4	Black	.750(19.1)	.695(17.7)	.590(15.0)	.695(17.7)	.625(15.9)	.512(13.0)
<b>Two Toned</b>			<b>Body-Top</b>					
5-1437622-5	KN501BA1/8	Blk. - Ntl.	.500(12.7)	.445(11.3)	.374(9.50)	.445(11.3)	.625(15.9)	.512(13.0)
5-1437622-4	KN501BA1/4	Blk. - Ntl.	.500(12.7)	.445(11.3)	.374(9.50)	.445(11.3)	.625(15.9)	.512(13.0)
6-1437622-5	KN701BA1/8	Blk. - Ntl.	.750(19.1)	.695(17.7)	.590(15.0)	.695(17.7)	.625(15.9)	.512(13.0)
6-1437622-4	KN701BA1/4	Blk. - Ntl.	.750(19.1)	.695(17.7)	.590(15.0)	.695(17.7)	.625(15.9)	.512(13.0)

**KN SERIES**



KN1751AS1/4



KN1751B1/4



Tyco Straight Knurl with & without "Fingertip" Spinner								
Electronics	Alcoswitch	Color	A	B	C	D	E	G
<b>Less Indicator</b>								
3-1437622-2	KN1751A1/4	Natural	1.75(44.5)	1.55(39.4)	1.38(35.1)	1.65(41.9)	.620(15.0)	.508(12.9)
3-1437622-6	KN1751B1/4	Black	1.75(44.5)	1.55(39.4)	1.38(35.1)	1.65(41.9)	.620(15.8)	.508(12.9)
<b>Two Toned</b>			<b>Body - Top</b>					
3-1437622-3	KN1751AB1/4	Ntl. - Blk.	1.75(44.5)	1.55(39.4)	1.38(35.1)	1.65(41.9)	.620(15.8)	.508(12.9)
3-1437622-7	KN1751BA1/4	Blk. - Natural	1.75(44.5)	1.55(39.4)	1.38(35.1)	1.65(41.9)	.620(15.8)	.508(12.9)
<b>With Indicator</b>								
3-1437622-5	KN1750A1/4	Natural	1.75(44.5)	1.55(39.4)	1.38(35.1)	1.65(41.9)	.620(15.8)	.508(12.9)
3-1437622-1	KN1750B1/4	Black	1.75(44.5)	1.55(39.4)	1.38(35.1)	1.65(41.9)	.620(15.8)	.508(12.9)
<b>With Spinner/Less Indicator</b>								
3-1437622-5	KN1751AS1/4	Natural	1.75(44.5)	1.55(39.4)	1.38(35.1)	1.65(41.9)	.620(15.8)	.508(12.9)
3-1437622-8	KN1751BS1/4	Black	1.75(44.5)	1.55(39.4)	1.38(35.1)	1.65(41.9)	.620(15.8)	.508(12.9)

**K**

**K Series**

K8



**Knobs, Machined Aluminum**



KN SERIES



KN5700B1/4

Concentric Set with Straight Knurl with Indicator Lines									
Tyco Electronics	Alcoswitch	Color	A	B	C	D	E	F	G
5-1437622-6	KN5700A1/4	Natural	.750(19.1)	.500(12.7)	.590(15.0)	.700(17.8)	.625(15.9)	1.16(29.5)	.281(7.14)
5-1437622-7	KN5700B1/4	Black	.750(19.1)	.500(12.7)	.590(15.0)	.700(17.8)	.625(15.9)	1.16(29.5)	.281(7.14)

Straight Knurl with & without Indicator Line Diameter Dimensions									
Tyco Electronics	Alcoswitch	Color Body-Top	A	B	C	D	E	F	G
4-1437622-3	KN500A1/8	Natural	.500(12.7)	.445(11.3)	.374(9.50)	.445(11.5)	.625(15.9)	.512(13.0)	.456(11.6)
4-1437622-2	KN500A1/4	Natural	.500(12.7)	.445(11.3)	.374(9.50)	.445(11.5)	.625(15.9)	.512(13.0)	.456(11.6)
4-1437622-7	KN500B1/8	Black	.500(12.7)	.445(11.3)	.374(9.50)	.445(11.5)	.625(15.9)	.512(13.0)	.456(11.6)
4-1437622-6	KN500B1/4	Black	.500(12.7)	.445(11.3)	.374(9.50)	.445(11.5)	.625(15.9)	.512(13.0)	.456(11.6)
5-1437622-8	KN700A1/4	Natural	.750(19.1)	.695(17.7)	.590(15.0)	.695(17.7)	.625(15.9)	.512(13.0)	.456(11.6)
6-1437622-0	KN700B1/4	Black	.750(19.1)	.695(17.7)	.590(15.0)	.695(17.7)	.625(15.9)	.512(13.0)	.456(11.6)
6-1437622-6	KN900A1/4	Natural	.949(24.1)	.894(22.7)	.696(17.7)	.894(22.7)	.625(15.9)	.512(13.0)	.456(11.6)
6-1437622-8	KN900B1/4	Black	.949(24.1)	.894(22.7)	.696(17.7)	.894(22.7)	.625(15.9)	.512(13.0)	.456(11.7)
2-1437622-5	KN1250A1/4	Natural	1.25(31.8)	1.20(30.5)	.984(25.0)	1.20(30.5)	.625(15.9)	.512(13.0)	.456(11.6)
2-1437622-7	KN1250B1/4	Black	1.25(31.8)	1.20(30.5)	.984(25.0)	1.20(30.5)	.625(15.9)	.512(13.0)	.456(11.6)
<b>Two-Toned</b>									
4-1437622-5	KN500AB1/8	Ntl - Blk.	.500(12.7)	.445(11.3)	.374(9.50)	.445(11.5)	.625(15.9)	.512(13.0)	.456(11.6)
4-1437622-4	KN500AB1/4	Ntl - Blk.	.500(12.7)	.445(11.3)	.374(9.50)	.445(11.5)	.625(15.9)	.512(13.0)	.456(11.6)
4-1437622-9	KN500BA1/8	Blk - Ntl.	.500(12.7)	.445(11.3)	.374(9.50)	.445(11.5)	.625(15.9)	.512(13.0)	.456(11.6)
4-1437622-8	KN500BA1/4	Blk - Ntl.	.500(12.7)	.445(11.3)	.374(9.50)	.445(11.5)	.625(15.9)	.512(13.0)	.456(11.6)
5-1437622-9	KN700AB1/4	Ntl - Blk.	.750(19.1)	.695(17.7)	.445(11.5)	.695(17.7)	.625(15.9)	.512(13.0)	.456(11.6)
6-1437622-1	KN700BA1/4	Blk - Ntl.	.750(19.1)	.695(17.7)	.445(11.5)	.695(17.7)	.625(15.9)	.512(13.0)	.456(11.6)
6-1437622-7	KN900AB1/4	Ntl - Blk.	.949(24.1)	.894(22.7)	.695(17.7)	.894(22.7)	.625(15.9)	.512(13.0)	.456(11.6)
6-1437622-9	KN900BA1/4	Blk - Ntl.	.949(24.1)	.894(22.7)	.695(17.7)	.894(22.7)	.625(15.9)	.512(13.0)	.456(11.7)
2-1437622-6	KN1250AB1/4	Ntl - Blk.	1.25(31.8)	1.20(30.5)	.984(25.0)	1.20(30.5)	.625(15.9)	.512(13.0)	.456(11.6)
2-1437622-8	KN1250BA1/4	Blk - Ntl.	1.25(31.8)	1.20(30.5)	.984(25.0)	1.20(30.5)	.625(15.9)	.512(13.0)	.456(11.6)
<b>Less Indicator</b>									
2-1437622-9	KN1251A1/4	Natural	1.25(31.8)	1.20(30.5)	.984(25.0)	1.25(31.7)	.625(15.9)	.512(13.0)	.456(11.7)
3-1437622-0	KN1251B1/4	Black	1.25(31.8)	1.20(30.5)	.984(25.0)	1.25(31.7)	.625(15.9)	.512(13.0)	.456(11.7)

KN SERIES



KN500A1/4



KN900BA1/4



KN SERIES



KN1755BS1/4

Straight Knurl with "Crank" Spinner									
Tyco Electronics	Alcoswitch	Color Body-Top/Spin	A	B	C	D	E	F	G
4-1437622-1	KN1755AS1/4	Natural	1.76(44.7)	1.56(39.5)	.138(35.0)	1.65(41.8)	.630(16.0)	.512(13.0)	.492(12.5)
	KN1755BS1/4	Black	1.76(44.7)	1.56(39.5)	.138(35.0)	1.65(41.8)	.630(16.0)	.512(13.0)	.492(12.5)
3-1437622-9	KN1755ABS1/4	Ntl.-Blk./Blk.	1.76(44.7)	1.56(39.5)	1.38(35.0)	1.65(41.8)	.630(16.0)	.512(13.0)	.492(12.5)
4-1437622-0	KN1755BAS1/4	Blk.-Ntl. Blk.	1.76(44.7)	1.56(39.5)	1.38(35.0)	1.65(41.8)	.630(16.0)	.512(13.0)	.492(12.5)

**Knobs, Machined Aluminum**

**KNS SERIES**



KNS501A1/4



KNS701B1/4

KNS701BA1/4



Tyco		Straight Knurl with Arrowhead Indicator on Skirt							
Electronics	Alcoswitch	Color	A	B	C	D	E	F	G
7-1437622-3	KNS501A1/8	Natural	.500(12.7)	.445(11.3)	.370(9.40)	.750(19.1)	.625(15.9)	.512(13.0)	.428(10.9)
7-1437622-2	KNS501A1/4	Natural	.500(12.7)	.445(11.3)	.370(9.40)	.750(19.1)	.625(15.9)	.512(13.0)	.428(10.9)
7-1437622-5	KNS501B1/8	Black	.500(12.7)	.445(11.3)	.370(9.40)	.750(19.1)	.625(15.9)	.512(13.0)	.428(10.9)
7-1437622-4	KNS501B1/4	Black	.500(12.7)	.445(11.3)	.370(9.40)	.750(19.1)	.625(15.9)	.512(13.0)	.428(10.9)
7-1437622-8	KNS701A1/4	Natural	.750(19.1)	.695(17.7)	.590(15.0)	1.12(28.5)	.625(15.9)	.512(13.0)	.428(10.9)
7-1437622-9	KNS701B1/4	Black	.750(19.1)	.695(17.7)	.590(15.0)	1.12(28.5)	.625(15.9)	.512(13.0)	.428(10.9)
<b>Two-Toned Body-Top/Skirt</b>									
7-1437622-7	KNS501BA1/8	Blk.- Ntl.	.500(12.7)	.695(17.7)	.370(9.40)	.750(19.1)	.625(15.9)	.512(13.0)	.428(10.9)
7-1437622-6	KNS501BA1/4	Blk.- Ntl.	.500(12.7)	.695(17.7)	.370(9.40)	.750(19.1)	.625(15.9)	.512(13.0)	.428(10.9)
8-1437622-1	KNS701BA1/8	Blk.- Ntl.	.750(19.1)	.695(17.7)	.590(15.0)	1.12(28.5)	.625(15.9)	.512(13.0)	.428(10.9)
8-1437622-0	KNS701BA1/4	Blk.- Ntl.	.750(19.1)	.695(17.7)	.590(15.0)	1.12(28.5)	.625(15.9)	.512(13.0)	.428(10.9)

**KPN SERIES**



KPN500B1/8



Tyco		Straight Knurl with Pointer and Indicator Line							
Electronics	Alcoswitch	Color	A	B	C	D	E	F	G
9-1437622-1	KPN500A1/8	Natural	.500(12.7)	.445(11.3)	.372(9.45)	.445(11.3)	.368(9.35)	.195(4.95)	.354(8.99)
9-1437622-0	KPN500A1/4	Natural	.500(12.7)	.445(11.3)	.372(9.45)	.445(11.3)	.368(9.35)	.195(4.95)	.354(8.99)
9-1437622-3	KPN500B1/8	Black	.500(12.7)	.445(11.3)	.372(9.45)	.445(11.3)	.368(9.35)	.195(4.95)	.354(8.99)
9-1437622-2	KPN500B1/4	Black	.500(12.7)	.445(11.3)	.372(9.45)	.445(11.3)	.368(9.35)	.195(4.95)	.354(8.99)
9-1437622-5	KPN700A1/4	Natural	.750(19.1)	.695(17.65)	.590(15.0)	.695(17.7)	.515(13.1)	.234(5.94)	.394(10.0)
9-1437622-6	KPN700B1/4	Black	.750(19.1)	.695(17.65)	.590(15.0)	.695(17.7)	.515(13.1)	.234(5.94)	.394(10.0)
9-1437622-7	KPN900A1/4	Natural	.937(23.8)	.882(22.40)	.692(17.6)	.882(22.4)	.630(16.0)	.276(7.01)	.350(8.90)
9-1437622-9	KPN900B1/4	Black	.937(23.8)	.882(22.40)	.692(17.6)	.882(22.4)	.630(16.0)	.276(7.01)	.350(8.90)

**KS SERIES**



KS500A1/4



Tyco		3 Flute Design with Aluminum Skirt and Indicator Line							
Electronics	Alcoswitch	Color	A	B	C	D	E	F	G
1437623-3	KS500A1/8	Natural	.500(12.7)	.430(10.9)	.360(9.14)	.750(19.1)	.620(15.8)	.510(13.0)	.430(10.9)
1437623-2	KS500A1/4	Natural	.500(12.7)	.430(10.9)	.360(9.14)	.750(19.1)	.620(15.8)	.510(13.0)	.430(10.9)
1437623-5	KS500B1/8	Black	.500(12.7)	.430(10.9)	.360(9.14)	.750(19.1)	.620(15.8)	.510(13.0)	.430(10.9)
1437623-4	KS500B1/4	Black	.500(12.7)	.430(10.9)	.360(9.14)	.750(19.1)	.620(15.8)	.510(13.0)	.430(10.9)
1437623-6	KS700A1/4	Natural	.750(19.0)	.650(16.5)	.590(14.9)	1.12(28.4)	.620(15.8)	.510(13.0)	.430(10.9)
1437623-7	KS700B1/4	Black	.750(19.0)	.650(16.5)	.590(14.9)	1.12(28.4)	.620(15.8)	.510(13.0)	.430(10.9)
1437623-8	KS900A1/4	Natural	.940(23.9)	.820(20.8)	.710(18.0)	1.40(35.6)	.620(15.8)	.510(13.0)	.430(10.9)
1437623-9	KS900B1/4	Black	.940(23.9)	.820(20.8)	.710(18.0)	1.40(35.6)	.620(15.8)	.510(13.0)	.430(10.9)



KS900B1/4

**K Series**

K10

**Knobs, Machined Aluminum**



**KT SERIES**



KT500A1/4



KT700A1/4

Tyco		Square Serration with Indicator Line							
Electronics	Alcoswitch	Color	A	B	C	D	E	F	G
1-1437623-2	KT500A1/4	Natural	.500(12.7)	.430(10.9)	.375(9.53)	.430(10.9)	.280(7.11)	.510(13.0)	.630(16.0)
1-1437623-4	KT500B1/8	Black	.500(12.7)	.430(10.9)	.375(9.53)	.430(10.9)	.280(7.11)	.510(13.0)	.630(16.0)
1-1437623-3	KT500B1/4	Black	.500(12.7)	.430(10.9)	.375(9.53)	.430(10.9)	.280(7.11)	.510(13.0)	.630(16.0)
1-1437623-6	KT700A1/4	Natural	.740(18.8)	.650(16.5)	.590(15.0)	.650(16.5)	.280(7.11)	.510(13.0)	.630(16.0)
1-1437623-7	KT700B1/4	Black	.740(18.8)	.650(16.5)	.590(15.0)	.650(16.5)	.280(7.11)	.510(13.0)	.630(16.0)
1-1437623-8	KT900A1/4	Natural	.940(23.9)	.816(20.7)	.710(18.0)	.816(20.7)	.280(7.11)	.510(13.0)	.630(16.0)
1-1437623-9	KT900B1/4	Black	.940(23.9)	.816(20.7)	.710(18.0)	.816(20.7)	.280(7.11)	.510(13.0)	.630(16.0)



**KU SERIES**



KU402B1/8

Tyco		Serrated Diamond Trim Cut with Dot Indicator							
Electronics	Alcoswitch	Color	A	B	C	D	E	F	G
2-1437623-1	KU401B1/8	Black	.374(9.50)	.283(7.19)	.276(7.01)	.098(2.49)	.177(4.50)	.236(5.99)	.299(7.60)
2-1437623-2	KU402B1/8	Black	.374(9.50)	.283(7.19)	.276(7.01)	.098(2.49)	.197(5.00)	.354(8.99)	.449(11.40)
2-1437623-3	KU500B1/8	Black	.500(12.7)	.409(10.4)	.374(9.50)	.118(3.00)	.276(7.01)	.512(13.0)	.598(15.2)
	KU500B1/4	Black	.500(12.7)	.409(10.4)	.374(9.50)	.118(3.00)	.276(7.01)	.512(13.0)	.598(15.2)
2-1437623-4	KU700B1/4	Black	.740(18.8)	.650(16.5)	.591(15.0)	.118(3.00)	.276(7.01)	.512(13.0)	.598(15.2)



**KUS SERIES**



KUS402B1/8



KUS700B1/4

Tyco		Serrated Diamond Trim Cut with Dot Indicator							
Electronics	Alcoswitch	Color	A	B	C	D	E	F	G
2-1437623-9	KUS402B1/8	Black	.374(9.50)	.197(5.00)	.276(7.01)	.520(13.2)	.098(2.49)	.450(11.4)	.354(8.99)
3-1437623-0	KUS500B1/8	Black	.500(12.7)	.276(7.01)	.374(9.50)	.700(17.8)	.118(3.00)	.600(15.2)	.512(13.0)
	KUS500B1/4	Black	.500(12.7)	.276(7.01)	.374(9.50)	.700(17.8)	.118(3.00)	.600(15.2)	.512(13.0)
3-1437623-1	KUS700B1/4	Black	.740(18.8)	.276(7.01)	.591(15.0)	1.03(26.2)	.118(3.00)	.600(15.2)	.512(13.0)

Note: KUS402B1/8 has #4.40 setscrew

**Knobs, Molded Phenolic**

**PH SERIES**



PH15181/4



Tyco		Straight Knurl Less Indicator Line					
Electronics	Alcoswitch	A	B	C	D	E	F
1437624-2	PH15181/4	.996(25.3)	.972(24.7)	.799(20.3)	.472(12.0)	.669(17.0)	.157(3.99)

**PK SERIES**



PK50B1/8



PK701/4



Tyco		Straight Knurl with Dot Indicator on Skirt					
Electronics	Alcoswitch	A	B	C	D	E	F
1437624-7	PK50B1/8	.748(19.0)	.570(14.5)	.500(12.70)	.055(1.40)	.460(11.7)	.550(13.97)
1437624-6	PK50B1/4	.748(19.0)	.570(14.5)	.500(12.70)	.055(1.40)	.460(11.7)	.550(13.97)
1437624-8	PK70B1/4	.984(25.0)	.728(18.5)	.710(18.03)	.079(2.01)	.500(12.7)	.590(14.99)
1437624-9	PK90B1/4	1.25(31.8)	.985(25.0)	.870(22.01)	.098(2.49)	.470(11.9)	.595(15.10)

**PK SERIES**



PK1100B1/4



Tyco		Serrated with Dot Indicator on Top					
Electronics	Alcoswitch	A	B	C	D	E	F
1437624-4	PK1100B1/8	.700(17.8)	.643(16.3)	.565(14.35)	.125(3.18)	.453(11.51)	.530(13.5)

**K**

**P Series**

**Knobs, Molded Phenolic**



**PKA SERIES**



PKA50B1/4



PKA90B1/4

Tyco Electronics Alcoswitch		Ribbed with Line Indicator on Skirt					
		A	B	C	D	E	F
1-1437624-1	PKA50B1/8	.795(20.2)	.580(14.7)	.540(13.7)	.080(2.03)	.450(11.4)	.590(15.0)
1-1437624-0	PKA50B1/4	.795(20.2)	.580(14.7)	.540(13.7)	.080(2.03)	.450(11.4)	.590(15.0)
1-1437624-4	PKA55B1/8	.780(19.8)	.580(14.7)	.475(12.1)	.135(3.43)	.585(14.9)	.675(17.2)
1-1437624-3	PKA55B1/4	.780(19.8)	.580(14.7)	.475(12.1)	.135(3.43)	.585(14.9)	.675(17.2)
1-1437624-5	PKA70B1/4	.980(24.9)	.740(18.8)	.680(17.3)	.118(3.00)	.650(16.5)	.750(19.1)
1-1437624-7	PKA90B1/4	1.375(34.9)	.970(24.6)	.670(17.0)	.195(4.95)	.750(19.1)	.840(21.3)



**PKAP SERIES**



PKAP50B1/8



PKAP90B1/4

Tyco Electronics Alcoswitch		Ribbed with Skirt and Pointer with Indicator Line					
		A	B	C	D	E	F
1-1437624-8	PKAP50B1/4	.787(20.0)	.693(17.6)	.508(12.9)	.082(2.08)	.579(14.7)	.689(17.5)
1-1437624-9	PKAP50B1/8	.787(20.0)	.693(17.6)	.508(12.9)	.082(2.08)	.579(14.7)	.689(17.5)
2-1437624-0	PKAP70B1/4	.976(24.8)	.874(22.1)	.668(17.0)	.158(4.01)	.634(16.1)	.737(18.72)

**Knobs, Molded Phenolic**

**PKB SERIES**



PKB90B1/4



		Fluted with Indicator Line On Skirt					
Tyco Electronics	Alcoswitch	A	B	C	D	E	F
2-1437624-3	PKB70B1/4	1.12(28.3)	.750(19.1)	.670(17.0)	.118(3.0)	.490(12.5)	.600(15.2)
2-1437624-4	PKB90B1/4	1.50(38.1)	1.02(25.8)	.800(20.3)	.118(3.0)	.705(17.9)	.820(20.8)

**PKD SERIES**



PKD60B1/4



PKD100B1/4



		Straight Knurl Aluminum Skirt w/Arrow Indicator					
Tyco Electronics	Alcoswitch	A	B	C	D	E	F
2-1437624-8	PKD60B1/8	.780(19.8)	.566(14.4)	.487(12.4)	.059(1.5)	.492(12.5)	.563(14.3)
2-1437624-7	PKD60B1/4	.780(19.8)	.566(14.4)	.487(12.4)	.059(1.5)	.492(12.5)	.563(14.3)
3-1437624-1	PKD70B1/4	1.02(25.9)	.750(19.1)	.700(17.8)	.080(2.0)	.490(12.5)	.610(15.5)
2-1437624-5	PKD100B1/4	1.29(32.8)	1.00(25.4)	.865(22.0)	.050(1.3)	.500(12.7)	.590(15.0)

**PKD SERIES**



PKD60B101/8



PKD100B101/4



		Straight Knurl Skirt w/0-10 Numerals					
Tyco Electronics	Alcoswitch	A	B	C	D	E	F
3-1437624-0	PKD60B101/8	.780(19.8)	.566(14.4)	.487(12.4)	.059(1.5)	.492(12.5)	.563(14.3)
2-1437624-9	PKD60B101/4	.780(19.8)	.566(14.4)	.487(12.4)	.059(1.5)	.492(12.5)	.563(14.3)
3-1437624-2	PKD70B101/4	1.02(25.9)	.750(19.1)	.700(17.8)	.080(2.0)	.490(12.5)	.610(15.5)
2-1437624-6	PKD100B101/4	1.29(32.8)	1.00(25.4)	.865(22.0)	.050(1.3)	.500(12.7)	.590(15.0)

**K**

P Series

**Knobs, Molded Phenolic**



**PKDT SERIES**



PKDT100B1/4

Tyco Black Spin Cap with "Diamond Cut" and Arrow Indicator							
Electronics	Alcoswitch	A	B	C	D	E	F
3-1437624-9	PKDT70B1/4	1.03(26.0)	.738(18.8)	.720(18.3)	.098(2.49)	.500(12.7)	.635(16.1)
3-1437624-3	PKDT100B1/4	1.29(32.8)	1.02(25.9)	.860(21.8)	.042(1.07)	.500(12.7)	.638(16.2)



**PKDT SERIES**



PKDT100B101/4

Tyco Black Spin Cap with "Diamond Cut" & 0-10 Numerals							
Electronics	Alcoswitch	A	B	C	D	E	F
3-1437624-8	PKDT60B101/8	.778(19.8)	.605(15.4)	.560(12.5)	.060(1.53)	.392(9.96)	.562(14.3)
4-1437624-0	PKDT70B101/4	1.03(26.0)	.738(18.8)	.720(18.3)	.098(2.49)	.500(12.7)	.635(16.1)
3-1437624-4	PKDT100B101/4	1.29(32.8)	1.02(25.9)	.860(21.8)	.042(1.07)	.500(12.7)	.638(16.2)



**PKE SERIES**



PKE90B1/4

Tyco Fluted with Indicator Line					
Electronics	Alcoswitch	A	B	C	E
4-1437624-4	PKE60B1/8	.626(15.9)	.472(12.0)	.091(2.31)	.472(12.0)
4-1437624-3	PKE60B1/4	.626(15.9)	.472(12.0)	.091(2.31)	.394(10.0)
4-1437624-5	PKE90B1/4	.890(22.6)	.724(18.4)	.098(2.49)	.480(12.2)



**PKES SERIES**



PKES60B1/4

Tyco Fluted with Skirt and Indicator Line							
Electronics	Alcoswitch	A	B	C	D	E	F
5-1437624-1	PKES60B1/8	.748(19.0)	.618(15.7)	.460(11.7)	.090(2.29)	.370(9.40)	.470(11.9)
5-1437624-0	PKES60B1/4	.748(19.0)	.618(15.7)	.460(11.7)	.090(2.29)	.370(9.40)	.470(11.9)
5-1437624-2	PKES70B1/4	.855(21.7)	.744(18.9)	.705(17.9)	.080(2.03)	.421(10.7)	.526(13.4)
5-1437624-3	PKES90B1/4	1.01(25.7)	.889(22.6)	.846(21.5)	.079(2.01)	.421(10.7)	.570(14.5)
4-1437624-6	PKES120B1/4	1.30(32.9)	1.16(29.5)	1.02(25.9)	.118(3.00)	.500(12.7)	.628(16.0)
4-1437624-7	PKES140B1/4	1.50(38.1)	1.37(34.9)	1.22(30.9)	.118(3.00)	.540(13.7)	.693(17.6)
4-1437624-8	PKES150B1/4	1.77(44.9)	1.55(39.4)	1.41(35.9)	.118(3.00)	.733(18.6)	.831(21.1)



PKES70B1/4

**Knobs, Molded Phenolic**

**PKF SERIES**



PKF50B1/8



Tyco Plain Quadrate with Indicator Line & Arrow					
Electronics	Alcoswitch	A	B	C	D
5-1437624-5	PKF50B1/8	.670(17.0)	.454(11.53)	.570(14.48)	.520(13.2)

**PKG SERIES**



PKG40B1/8



Tyco Ribbed with Indicator Line							
Electronics	Alcoswitch	A	B	C	D	E	F
5-1437624-9	*PKG40B1/8	.437(11.1)	.410(10.4)	.304(7.72)	.079(2.00)	.385(9.78)	.472(12.0)
6-1437624-1	PKG50B1/8	.551(14.0)	.500(12.7)	.442(10.7)	.056(1.42)	.395(10.03)	.512(13.0)
6-1437624-0	PKG50B1/4	.551(14.0)	.500(12.7)	.442(10.7)	.056(1.42)	.395(10.03)	.512(13.0)

\*Note: Knob uses #4-40 set screw



**Knobs, Molded Phenolic**

**PKG SERIES**



PKG70B1/8

Tyco		Ribbed with Indicator Line					
Electronics	Alcoswitch	A	B	C	D	E	F
6-1437624-6	PKG60B1/8	.660(16.8)	.615(15.6)	.551(14.0)	.080(2.03)	.430(10.9)	.551(14.0)
6-1437624-5	PKG60B1/4	.660(16.8)	.615(15.6)	.551(14.0)	.080(2.03)	.430(10.9)	.551(14.0)
6-1437624-8	PKG70B1/8	.740(18.8)	.698(17.7)	.591(15.0)	.080(2.03)	.453(11.5)	.559(14.2)
6-1437624-7	PKG70B1/4	.740(18.8)	.698(17.7)	.591(15.0)	.080(2.03)	.453(11.5)	.559(14.2)

**PKG SERIES**



PKG90B1/4

Tyco		Ribbed with Indicator Line					
Electronics	Alcoswitch	A	B	C	D	E	F
7-1437624-0	PKG90B1/8	.862(21.9)	.811(20.6)	.710(18.0)	.080(2.03)	.450(11.4)	.550(13.97)
6-1437624-9	PKG90B1/4	.862(21.9)	.811(20.6)	.710(18.0)	.080(2.03)	.450(11.4)	.550(13.97)
5-1437624-7	PKG100B1/4	1.055(26.80)	1.01(25.5)	.920(23.4)	.080(2.03)	.430(10.9)	.555(14.1)
5-1437624-8	PKG125B1/4	1.248(31.70)	1.20(30.4)	.690(17.5)	.080(2.03)	.430(10.9)	.565(14.4)

**PKGP SERIES**



PKGP70B1/4

Tyco		Ribbed with Bar Pointers and Indicator Line					
Electronics	Alcoswitch	A	B	C	D	E	F
7-1437624-2	PKGP70B1/4	.740(18.8)	.700(17.8)	.590(15.0)	.990(25.2)	.080(2.03)	.460(11.7)
7-1437624-3	PKGP90B1/4	.860(21.8)	.810(20.6)	.700(17.8)	1.28(32.5)	.080(2.03)	.460(11.7)
7-1437624-1	PKGP100B1/4	1.05(26.2)	1.00(25.4)	.900(22.9)	1.62(41.2)	.080(2.03)	.480(12.2)

**PKJ SERIES**



PKJ50B1/8

Tyco		Straight Knurl with Bar Pointers and Indicator Line					
Electronics	Alcoswitch	A	B	C	D	E	F
7-1437624-5	PKJ50B1/8	.500(12.7)	.512(13.0)	.420(10.7)	.577(14.7)	.429(10.9)	.113(2.9)
7-1437624-4	*PKJ50B1/4	.500(12.7)	.512(13.0)	.420(10.7)	.577(14.7)	.429(10.9)	.113(2.9)
7-1437624-6	PKJ60B1/4	.630(16.0)	.530(13.5)	.468(11.9)	.758(19.3)	.440(11.2)	.110(2.8)
7-1437624-7	PKJ70B1/4	.760(19.3)	.555(14.1)	.545(13.8)	.915(23.2)	.450(11.4)	.118(3.0)



PKJ70B1/4

**Knobs, Molded Phenolic**

**PKJT SERIES**



PKJT50B1/4



PKJT70B1/4



Straight Knurl with Bar Pointer & Indicator Line and Aluminum Spin Cap							
Tyco							
Electronics	Alcoswitch	A	B	C	D	E	F
7-1437624-9	PKJT50B1/8	.515(13.1)	.585(14.9)	.350(8.89)	.595(15.1)	.414(10.5)	.130(3.30)
7-1437624-8	*PKJT50B1/4	.515(13.1)	.585(14.9)	.350(8.89)	.595(15.1)	.414(10.5)	.130(3.30)
8-1437624-0	PKJT60B1/4	.640(16.3)	.605(15.4)	.470(11.9)	.760(19.3)	.445(11.3)	.118(3.00)
8-1437624-1	PKJT70B1/4	.760(19.3)	.625(15.9)	.550(14.0)	.915(23.2)	.445(11.3)	.118(3.00)

\*Knob uses #4-40 set screw.

**PKNT SERIES**



PKNT60B1/4

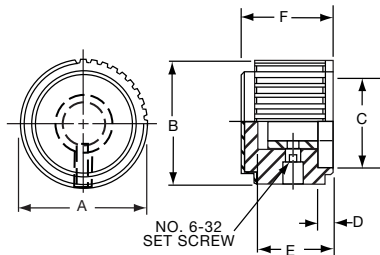

Black Spin Cap with "Diamond Cut" Less Indicator							
Tyco							
Electronics	Alcoswitch	A	B	C	D	E	F
8-1437624-6	PKNT60B1/8	.591(15.0)	.579(14.7)	.394(10.0)	.079(2.01)	.394(10.0)	.472(11.9)
8-1437624-5	PKNT60B1/4	.591(15.0)	.579(14.7)	.394(10.0)	.079(2.01)	.394(10.0)	.472(11.9)
8-1437624-7	PKNT70B1/4	.787(19.9)	.764(19.4)	.571(14.5)	.098(2.49)	.492(12.5)	.591(14.7)
8-1437624-8	PKNT90B1/4	.984(25.0)	.957(24.3)	.748(19.0)	.098(2.49)	.591(15.0)	.689(17.5)

**PKN SERIES**



PKN60B1/8



Line Indicator on Natural Aluminum Spin Cap							
Tyco							
Electronics	Alcoswitch	A	B	C	D	E	F
8-1437624-2	PKN60B1/8	.591(15.0)	.579(14.7)	.394(10.0)	.079(2.01)	.394(10.0)	.453(11.5)
	PKN60B1/4	.591(15.0)	.579(14.7)	.394(10.0)	.079(2.01)	.394(10.0)	.453(11.5)
8-1437624-3	PKN70B1/4	.787(20.0)	.764(19.4)	.571(14.5)	.098(2.49)	.492(12.5)	.591(15.0)
8-1437624-4	PKN90B1/4	.984(25.0)	.957(24.3)	.748(19.0)	.098(2.49)	.591(15.0)	.689(17.5)

K

P Series

**Knobs, Molded Phenolic**

PKS SERIES



PKS1104B1/4

		Straight Knurl with Indicator Line on Skirt					
Tyco Electronics	Alcoswitch	A	B	C	D	E	F
9-1437624-5	PKS1104B1/4	1.12(28.5)	.567(14.4)	.620(15.8)	.090(2.29)	.510(12.95)	.670(17.0)

PKS SERIES

		Straight Knurl Aluminum Skirt Has Line or 0-9 Numbers						
Tyco Electronics	Alcoswitch	A	B	C	D	E	F	Marking
9-1437624-4	PKS1103B101/4	1.17(29.6)	.571(14.5)	.620(15.7)	.098(2.49)	.516(13.1)	.670(17.0)	Numbers
9-1437624-7	PKS1106B1/4	1.17(29.6)	.571(14.5)	.618(15.7)	.098(2.49)	.516(13.1)	.670(17.0)	Line
9-1437624-6	PKS1105B101/4	1.17(29.6)	.571(14.5)	.618(15.7)	.098(2.49)	.516(13.1)	.670(17.0)	Numbers



PKS1106B1/4



PKS1103B101/4



PKS1105B101/4



PKS SERIES

SPUN ALUMINUM INLAY



0-10



+5-5



0-9



Indicator Line



PKS1132B51/4

		Choice of Indicator Line or 0-9, 0-10, -5+5 Numerals						
Tyco Electronics	Alcoswitch	A	B	C	D	E	F	Marking
1437625-1	PKS1132B51/4	1.18(30.0)	.551(14.0)	.551(14.0)	.118(30.0)	.615(15.62)	.748(19.0)	+5-0-5
1437625-2	PKS1132B91/4	1.18(30.0)	.551(14.0)	.551(14.0)	.118(30.0)	.615(15.62)	.748(19.0)	0-9
9-1437624-9	PKS1132B101/4	1.18(30.0)	.551(14.0)	.551(14.0)	.118(30.0)	.615(15.62)	.748(19.0)	0-10
9-1437624-8	*PKS1132B1/4	1.18(30.0)	.551(14.0)	.551(14.0)	.118(30.0)	.615(15.62)	.748(19.0)	Indicator Line

\*1 Set screw 180° from indicator line.



PKS1132B91/4

**Knobs, Molded Phenolic**

**PKS SERIES**



PKS90B1/4



PKS90B101/4



Tyco Straight Knurl with Aluminum Skirt Choice of Arrow or 1-10 Numbers									
Electronics	Alcoswitch	A	B	C	D	E	F	Marking	
1437625-5	PKS90B1/4	1.42(36.1)	.917(23.3)	.780(19.8)	.065(1.65)	.490(12.5)	.596(15.1)	Arrow	
1437625-6	PKS90B101/4	1.42(36.1)	.917(23.3)	.780(19.8)	.065(1.65)	.490(12.5)	.596(15.1)	Numbers	

**PKX SERIES**



PKX50B1/8



(1) 6-32 SET SCREW EXCEPT PKX-50B, (1) 4-40

Tyco Ribbed Body, Matte Finish with White Square Indicator on Top							
Electronics	Alcoswitch	A	B	C	D	E	F
1-1437625-5	PKX50B1/8	.590(15.0)	.472(12.0)	.374(9.49)	.059(1.50)	.463(11.76)	.551(14.0)
1-1437625-4	PKX50B1/4	.590(15.0)	.472(12.0)	.374(9.49)	.059(1.50)	.463(11.76)	.551(14.0)
1-1437625-7	PKX60B1/8	.787(20.0)	.625(15.9)	.472(12.0)	.078(1.98)	.510(13.0)	.598(15.2)
1-1437625-6	PKX60B1/4	.787(20.0)	.625(15.9)	.472(12.0)	.078(1.98)	.510(13.0)	.598(15.2)

**PKX SERIES**



PKX110B1/4



Tyco Ribbed Body, Matte Finish with White Square Indicator on Top							
Electronics	Alcoswitch	A	B	C	D	E	F
1-1437625-1	PKX100B1/4	1.17(29.7)	.970(24.6)	.780(19.81)	.114(2.90)	.570(14.48)	.674(17.12)
1-1437625-2	PKX110B1/4	1.37(34.8)	1.120(28.45)	.940(23.88)	.100(2.54)	.527(13.38)	.705(17.91)
1-1437625-3	PKX130B1/4	1.57(40.0)	1.308(33.22)	1.09(27.6)	.118(3.00)	.623(15.82)	.750(19.05)

K

P Series

**Knob Accessories**

ACCESSORIES

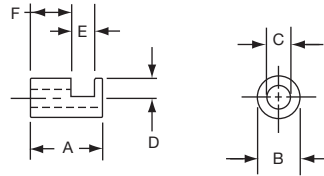

KR1

Tyco		Shaft Hole Size Adaptors					
Electronics	Alcoswitch	A	B	C	D	E	F
9-1437627-6	KR1 (1/4"TO1/8")	.374(9.50)	.250(6.35)	.128(3.25)	.122(3.10)	.217(5.51)	.122(3.10)
9-1437627-7	KR2 (1/4"TO3/16")	.375(9.53)	.250(6.35)	.190(4.83)	.122(3.10)	.216(5.49)	.123(3.12)
9-1437627-8	KR3 (1/4"TO4MM)	.375(9.53)	.248(6.30)	.161(4.09)	.122(3.10)	.216(5.49)	.123(3.12)

**Engineering Notes**



**K**

Engineering Notes

K22

Catalog 1308390  
Issued 9-04

[www.tycoelectronics.com](http://www.tycoelectronics.com)

Dimensions are in inches and millimeters unless otherwise specified. Values in parentheses or brackets are metric equivalents.

Dimensions are shown for reference purposes only. Specifications subject to change.

USA: 1-800-522-6752  
Canada: 1-905-470-4425  
Mexico: 01-800-733-8926  
C. America: 52-55-5-729-0425

South America: 55-11-3611-1514  
Hong Kong: 852-2735-1628  
Japan: 81-44-844-8013  
UK: 44-141-810-8967



Компания «ЭлектроПласт» предлагает заключение долгосрочных отношений при поставках импортных электронных компонентов на взаимовыгодных условиях!

Наши преимущества:

- Оперативные поставки широкого спектра электронных компонентов отечественного и импортного производства напрямую от производителей и с крупнейших мировых складов;
- Поставка более 17-ти миллионов наименований электронных компонентов;
- Поставка сложных, дефицитных, либо снятых с производства позиций;
- Оперативные сроки поставки под заказ (от 5 рабочих дней);
- Экспресс доставка в любую точку России;
- Техническая поддержка проекта, помощь в подборе аналогов, поставка прототипов;
- Система менеджмента качества сертифицирована по Международному стандарту ISO 9001;
- Лицензия ФСБ на осуществление работ с использованием сведений, составляющих государственную тайну;
- Поставка специализированных компонентов (Xilinx, Altera, Analog Devices, Intersil, Interpoint, Microsemi, Aeroflex, Peregrine, Syfer, Eurofarad, Texas Instrument, Miteq, Cobham, E2V, MA-COM, Hittite, Mini-Circuits, General Dynamics и др.);

Помимо этого, одним из направлений компании «ЭлектроПласт» является направление «Источники питания». Мы предлагаем Вам помощь Конструкторского отдела:

- Подбор оптимального решения, техническое обоснование при выборе компонента;
- Подбор аналогов;
- Консультации по применению компонента;
- Поставка образцов и прототипов;
- Техническая поддержка проекта;
- Защита от снятия компонента с производства.



#### Как с нами связаться

**Телефон:** 8 (812) 309 58 32 (многоканальный)

**Факс:** 8 (812) 320-02-42

**Электронная почта:** [org@eplast1.ru](mailto:org@eplast1.ru)

**Адрес:** 198099, г. Санкт-Петербург, ул. Калинина, дом 2, корпус 4, литера А.