

PI-7302-061214

Figure 2. Functional Block Diagram.

**Pin Functional Description**

**DRAIN (D) Pin:**

Power MOSFET drain connection. It also provides internal operating current during start-up and in steady-state operation.

**BYPASS (BP) Pin:**

Connection point for the external 1  $\mu$ F bypass capacitor connected to the internally generated 6 V supply.

**FEEDBACK (FB) Pin:**

Controls switching of the power MOSFET during normal operation. This pin senses the AC voltage on the bias winding. Input is used to regulate both the output voltage in CV mode and output current in CC mode based on voltage across the bias winding in the flyback portion of the switching cycle. The internal inductance correction circuit uses voltage on the bias winding during forward part of the switching cycle to sense the bulk capacitor voltage.

**SOURCE (S) Pin:**

Connected to the MOSFET source and is used for high-voltage power and control circuit common returns.

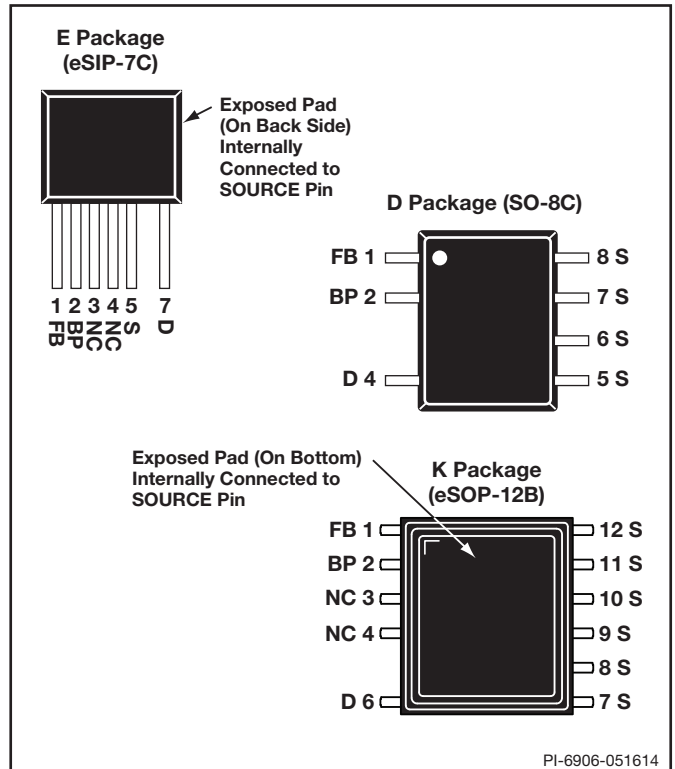

PI-6906-051614

Figure 3. Pin Configuration.

## LYTSwitch-2 Functional Description

The LYTSwitch-2 IC combines a high-voltage power MOSFET switch with a power supply controller in one device. Similar to the LinkSwitch-LP and TinySwitch-III ICs it uses an ON/OFF control to regulate the output voltage. In addition, the switching frequency is modulated to regulate the output current to provide a constant current characteristic. The LYTSwitch-2 controller consists of an oscillator, feedback (sense and logic) circuit, 6 V regulator, over-temperature protection, frequency jittering, current limit circuit, leading-edge blanking, inductance correction circuitry, frequency control for constant current regulation and ON/OFF state-machine for CV control.

### Inductance Correction Circuitry

If the primary magnetizing inductance is either too high or low the converter will automatically compensate for this by adjusting the oscillator frequency. Since this controller is designed to operate in discontinuous-conduction mode the output power is directly proportional to the set primary inductance and its tolerance can be completely compensated with adjustments to the switching frequency.

### Constant Current (CC) Operation

As the output voltage and therefore the flyback voltage across the bias winding ramps up, the FEEDBACK pin voltage increases. The switching frequency is adjusted as the FEEDBACK pin voltage increases to provide a constant output current regulation. The constant current circuit and the inductance correction circuit are designed to operate concurrently in the CC region.

### Constant Voltage (CV) Operation

As the FEEDBACK pin approaches 2 V from the constant current regulation mode, the power supply transitions into CV operation. The switching frequency at this point is at its maximum value, corresponding to the peak power point of the CV/CC characteristic. The controller regulates the FEEDBACK pin voltage to remain at FEEDBACK pin threshold ( $V_{FBTH}$ ) using an ON/OFF state-machine. The FEEDBACK pin voltage is sampled 2.5  $\mu$ s after the turn-off of the high-voltage switch. At light loads the current limit is also reduced to decrease the transformer flux density and the FEEDBACK pin sampling is done earlier.

### Auto-Restart and Open-Loop Protection

In the event of a fault condition such as an output short or an open-loop condition the LYTSwitch-2 IC enters into an appropriate protection mode.

In the event the FEEDBACK pin voltage during the flyback period falls below 0.7 V before the FEEDBACK pin sampling delay ( $\sim 2.5 \mu$ s) for a duration in excess of  $\sim 450$  ms (auto-restart on-time ( $t_{AR-ON}$ )) the converter enters into auto-restart, wherein the power MOSFET is disabled for 1.2 seconds. The auto-restart alternately enables and disables the switching of the power MOSFET until the fault condition is removed.

In addition to the conditions for auto-restart described above, if the sensed FEEDBACK pin current during the forward period of the conduction cycle (switch "on" time) falls below 120  $\mu$ A, the converter annunciates this as an open-loop condition (top resistor in potential divider is open or missing) and reduces the auto-restart time from 450 ms to approximately 6 clock cycles (90  $\mu$ s), whilst keeping the disable period of 2 seconds.

### Over-Temperature Protection

The thermal shutdown circuitry senses the die temperature. The threshold is set at 142  $^{\circ}$ C typical with a 60  $^{\circ}$ C hysteresis. When the die temperature rises above this threshold (142  $^{\circ}$ C) the power MOSFET is disabled and remains disabled until the die temperature falls by 60  $^{\circ}$ C, at which point the MOSFET is re-enabled.

### Current Limit

The current limit circuit senses the current in the power MOSFET. When this current exceeds the internal threshold ( $I_{LIMIT}$ ), the power MOSFET is turned off for the remainder of that cycle. The leading edge blanking circuit inhibits the current limit comparator for a short time ( $t_{LEB}$ ) after the power MOSFET is turned on. This leading edge blanking time has been set so that current spikes caused by capacitance and rectifier reverse recovery time will not cause premature termination of the MOSFET conduction. The LYTSwitch-2 IC also contains a "di/dt" correction feature to minimize CC variation across the input line range.

### 6 V Regulator

The 6 V regulator charges the bypass capacitor connected to the BYPASS pin to 6 V by drawing a current from the voltage on the DRAIN pin, whenever the MOSFET is off. The BYPASS pin is the internal supply voltage node. When the MOSFET is on, the device runs off of the energy stored in the bypass capacitor. Extremely low power consumption of the internal circuitry allows the LYTSwitch-2 IC to operate continuously from the current drawn from the DRAIN pin. A bypass capacitor value of 1  $\mu$ F is sufficient for both high frequency decoupling and energy storage.

## Applications Example

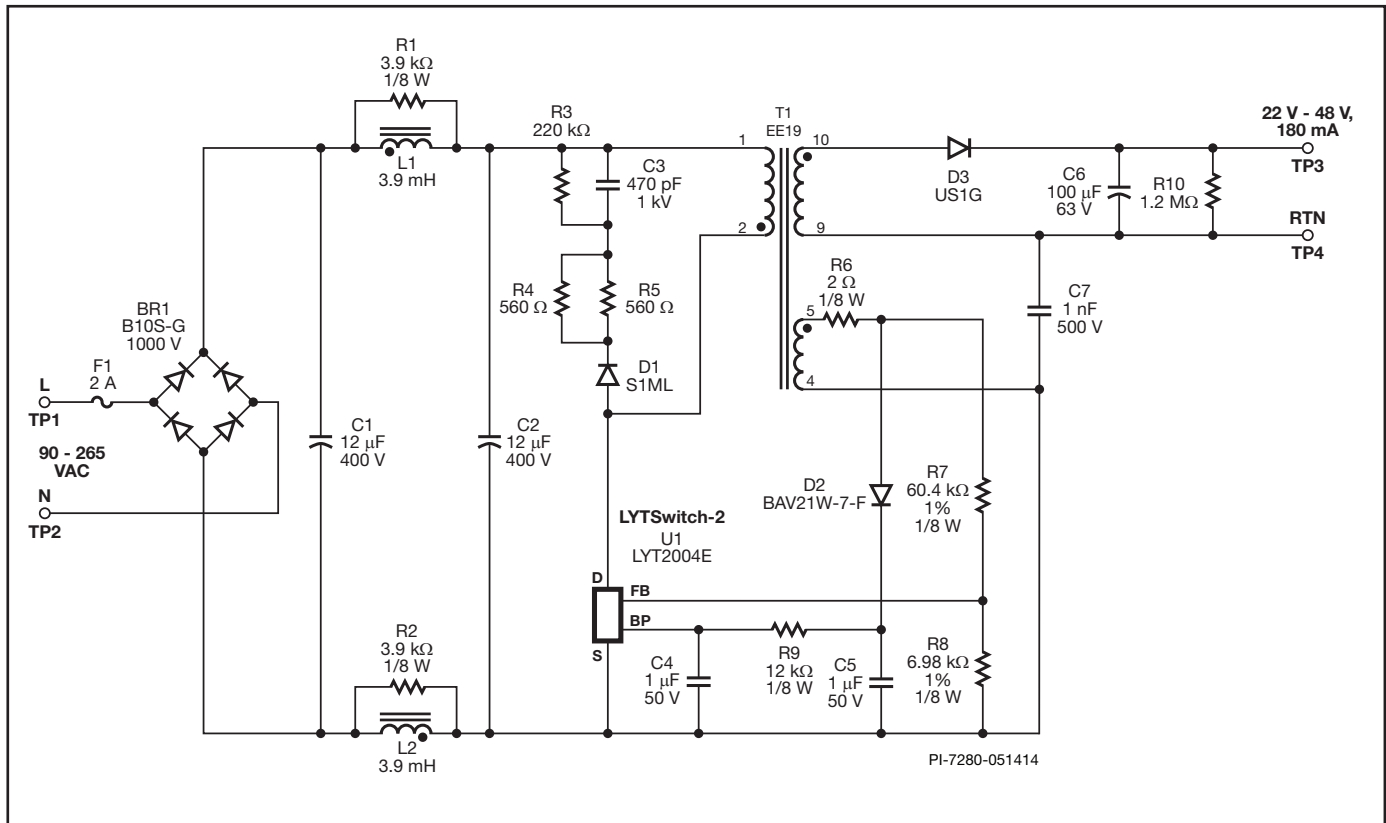

Figure 4. Energy Efficient 8.6 W LED Power Supply (>86% Average Efficiency, <30 mW No-load Input Power).

### Circuit Description

This circuit shown in Figure 4 is configured as a primary-side regulated flyback power supply utilizing the LYT2004E from the LYTSwitch-2 family of ICs. This type of LED driver design is typical for an external ballast application where safety isolation is required while power factor correction is not. The output can drive an LED load from 48 V to 22 V with a constant output current of 180 mA  $\pm$ 5% across input range of 90 VAC to 265 VAC and ambient temperature range of 0 °C to 60 °C. It has an average efficiency of >86% and <30 mW no-load input power measured at nominal input voltages (i.e. 115 VAC and 230 VAC). This design easily meets the most stringent current energy efficiency requirements.

#### Input Filter

AC input power is rectified by bridge diode BR1. The rectified DC is filtered by the bulk storage capacitors C1 and C2. Inductor L1, L2, C1 and C2 form a pi ( $\pi$ ) filter, which attenuates conducted differential-mode EMI. Resistors R1 and R2 placed across the inductors damp the Q to improve frequency noise filtering without reducing low frequency noise attenuation. A small value Y capacitor (C7) across the transformer was used to reduce common-mode noise currents. The fuse F1 provides protection against catastrophic failure. This can be replaced by a fusible resistor for cost reduction but should be suitably rated

(and typically a wire wound type) to withstand the instantaneous dissipation experienced during input capacitor charging when first connected to the AC line.

#### LYT2004 Primary

The LYTSwitch-2 family (U1) incorporates the power switching device, oscillator, CC/CV control engine, start-up, and protection functions. The integrated 725 V power MOSFET provides a large drain voltage margin in universal input AC applications, increasing reliability and also reducing the output diode voltage stress by permitting the use of higher transformer turns ratios. The device is completely self-powered from the BYPASS pin and decoupling capacitor C4.

The optional bias supply formed by D2 and C5 and R6 provides operating current to U1 via resistor R9. This reduces the no-load consumption from 200 mW to less than 30 mW. The bias supply also increases light load efficiency.

The rectified and filtered input voltage is applied to one side of the primary winding of T1. The other side of the transformer's primary winding is driven by the integrated power MOSFET in U1. The leakage inductance drain voltage spike is limited by an RCD-R clamp consisting of D1, R3, R4, R5, and C3.

### Output Rectification

The output from the transformer is rectified by D3, a 1 A, 400 V ultrafast recovery type diode (for higher efficiency), and filtered by C6. In this application C6 was sized to meet a (typical) ripple requirement of less than 10% without the need for an additional LC post filter.

A pre-load resistor R10 was employed to discharge the output capacitor and extinguish the LED light immediately after turn-off. The resistor will also keep the output from rising higher than the permitted maximum output voltage (usually determined by the output capacitor voltage rating) when the load is disconnected.

### Output Regulation

The LYTSwitch-2 family regulates the output using ON/OFF control in the constant voltage (CV) regulation region of the output characteristic and frequency control for the constant current (CC) region. The feedback resistors (R7 and R8) were selected using standard 1% resistors to center both the nominal output voltage and constant current regulation thresholds. Resistor R6 acts as filter to limit the voltage spike (caused by the coupling of the bias winding to the primary winding), improving regulation.

## Key Application Considerations

### Output Power Table

The data sheet maximum output power table (Table 1) represents the maximum practical continuous output power that can be obtained under the following assumed conditions:

1. The minimum DC bus voltage is 100 V at 90 VAC input. The value of the input capacitance should be made large enough to meet this requirement for AC input designs – typically 2-3  $\mu\text{F}/\text{W}$  for low-line or universal input designs and 1-2  $\mu\text{F}/\text{W}$  for high-line input designs.
2. The secondary output rectifier diode should withstand peak inverse voltage (PIV) for 55 V output voltage for open load condition.
3. Assume efficiency of >80%.
4. Discontinuous mode operation ( $K_p > 1.3$ ).
5. The LYTSwitch-2 part is either board mounted with SOURCE pins soldered to a sufficient area of copper to keep the SOURCE pin temperature at or below 100 °C, or (in the case of the E package) attached to a sufficiently sized heat sink to limit device temperature to below 110 °C.
6. Ambient temperature of less than 50 °C for open frame designs and an internal enclosure temperature of 60 °C for enclosed ballast-type designs.

Note: Higher output powers are achievable if an output CC tolerance >  $\pm 10\%$  is acceptable, and allowing the device to be operated at a higher SOURCE pin temperature.

### Output Tolerance

LYTSwitch-2 K and E package parts provides an overall CC mode output current tolerance of  $\pm 5\%$  including line voltage, normal board-to-board component variation and across a temperature range of 0 °C to 110 °C. For the D package (SO-8) additional CC variance may occur due to stress caused by

manufacturing (i.e. solder-wave immersion or  $I_R$  reflow). A sample power supply build is recommended to verify production tolerances for each design.

### BYPASS Pin Capacitor Selection

A 1  $\mu\text{F}$  BYPASS pin capacitor is recommended. The capacitor voltage rating should be greater than 7 V. The capacitor can be ceramic or electrolytic but tolerance of capacitor should be  $\leq \pm 50\%$ . The capacitor must be physically located close to the LYTSwitch-2 BYPASS pin for effective noise decoupling.

## LYTSwitch-2 Layout Considerations

### Circuit Board Layout

The LYTSwitch-2 family of ICs present a highly integrated power supply solution that integrates, both, the controller and the high-voltage power MOSFET onto a single die. The presence of high switching currents and voltages together with analog signals makes it especially important to follow good PCB design practice to ensure stable and trouble free operation of the power supply. See Figures 5 and 6 for a recommended circuit board layout for LYTSwitch-2.

When designing a printed circuit board layout for the LYTSwitch-2 based power supply, it is important to follow these guidelines:

### Single Point Grounding

Use a single point (Kelvin) connection at the negative terminal of the input filter capacitor for the LYTSwitch-2 SOURCE pin and bias winding return. This improves surge capabilities by returning surge currents from the bias winding directly to the input filter capacitor.

### Bypass Capacitor

The BYPASS pin capacitor should be located as close as possible to the SOURCE and BYPASS pins for effective noise decoupling.

### Feedback Resistors

Place the feedback resistors (R7 and R8) very close to the FEEDBACK pin of the LYTSwitch-2 device. This minimizes noise coupling.

### Thermal Considerations (D and K Package)

The copper area connected to the SOURCE pins provides heat sinking. A good estimate of expected power dissipation is to assume that the LYTSwitch-2 will dissipate 5% of the output power. Provide enough copper area to keep the SOURCE pin temperature below 100 °C. Higher temperatures are allowable but output current (CC) tolerance will increase. In this case a maximum SOURCE pin temperature below 100 °C is recommended to provide margin for part-to-part  $R_{DS(ON)}$  variation.

### Secondary Loop Area

To minimize leakage inductance and EMI the area of the loop contained within the connections between the secondary winding (T1), the output diode (D3) and the output filter capacitor (C6) should be minimized. In addition, sufficient copper area should be to the rectifier diode for heat sinking preferably connected to the quiet cathode terminal. A large anode area can increase high frequency radiated EMI.

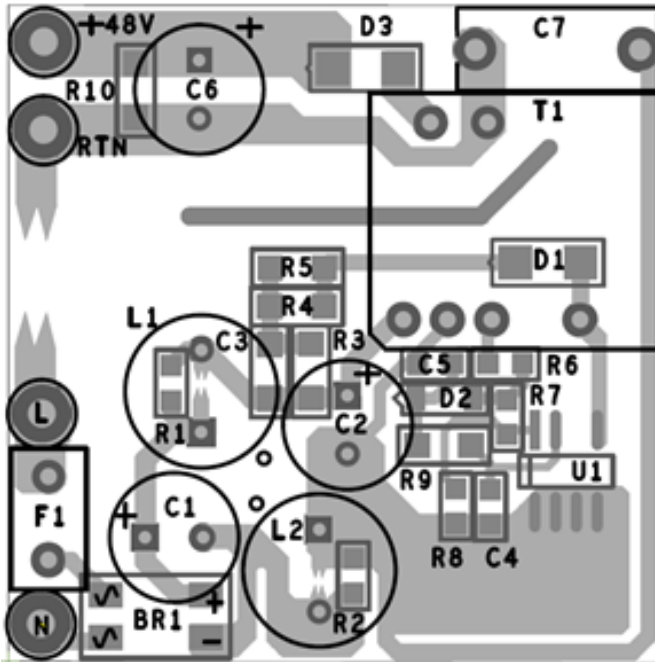

Figure 5. PCB Layout Example using SO-8C Package.

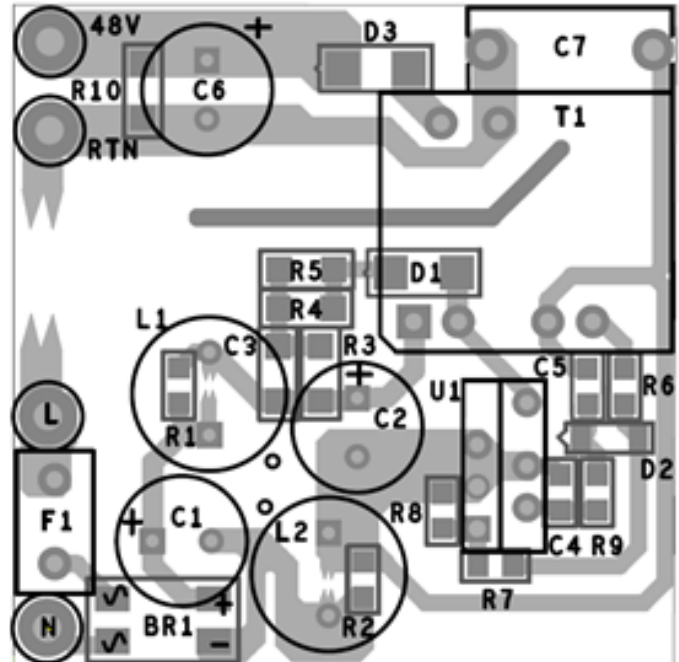

Figure 6. PCB Layout Example using eSIP Package.

### Electrostatic Discharge Spark Gap

A trace is placed at one of the AC line inputs to form one electrode of a spark gap. The other electrode on the secondary is formed by the output return node. The spark gap directs most ESD energy from the secondary back to the AC input during a surge event. The trace from the AC input to the spark gap electrode should be spaced away from other traces to prevent unwanted arcing occurring and possible circuit damage. If R1 and R2 are removed additional spark gaps across the EMI filter inductors (L1 and L2) to prevent excessive build-up of voltage across them during surge.

### Drain Clamp Optimization

LYTSwitch-2 ICs use primary-side sensing to regulate the output. The voltage that appears on the primary winding is a reflection of the secondary winding voltage while the internal is off. Leakage inductance induced ringing can affect output regulation. Optimizing the drain clamp to minimize high frequency ringing will give the best regulation. Figure 7 shows the desired drain voltage waveform; while Figure 8 shows a large undershoot due to a leakage inductance induced ring. Ringing can be reduced (and hence regulation improved) by adjusting the value of the resistor in series with the primary clamp diode.

### Addition of a Bias Circuit for Higher Light Load Efficiency and Lower No-load Input Power Consumption

The addition of a bias circuit can decrease the no-load input power from ~200 mW to less than 30 mW at 230 VAC input.

The power supply schematic shown in Figure 4 has the bias circuit incorporated. Diode D2, C5 and R9 form the bias circuit.

Diode D2 rectifies the output and C5 is the filter capacitor. A 1  $\mu$ F capacitor is recommended to maintain the minimum bias voltage at low switching frequencies.

The recommended current into the BYPASS pin is equal to IC supply current (~0.5 mA) at the minimum bias winding voltage. The BYPASS pin current should not exceed 3 mA at the maximum bias winding voltage. The value of R9 is calculated according to  $(V_{BIAS} - V_{BP}) / I_{S2}$ , where  $V_{BIAS}$  (10 V typical) is the voltage across C5,  $I_{S2}$  (0.5 mA typ.) is the IC supply current and  $V_{BP}$  (6.2 V typ.) is the BYPASS pin voltage.

The parameters  $I_{S2}$  and  $V_{BP}$  are provided in the parameter table of the LYTSwitch-2 data sheet. Diode D2 can be a low-cost type such as FR102, 1N4148 or BAV19/20/21.

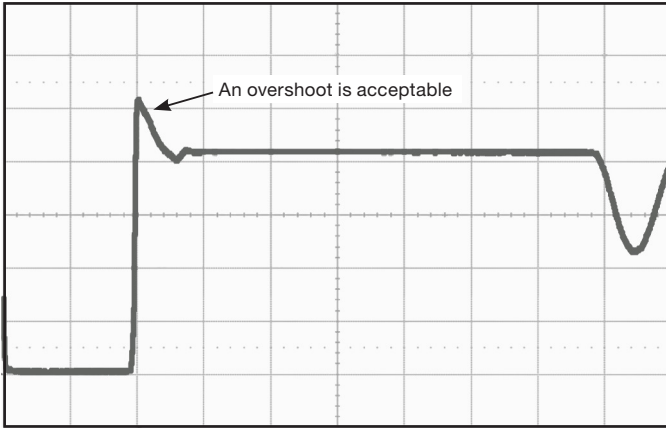

Figure 7. Desired Drain Voltage Waveform with Minimal Leakage Ringing Undershoot.

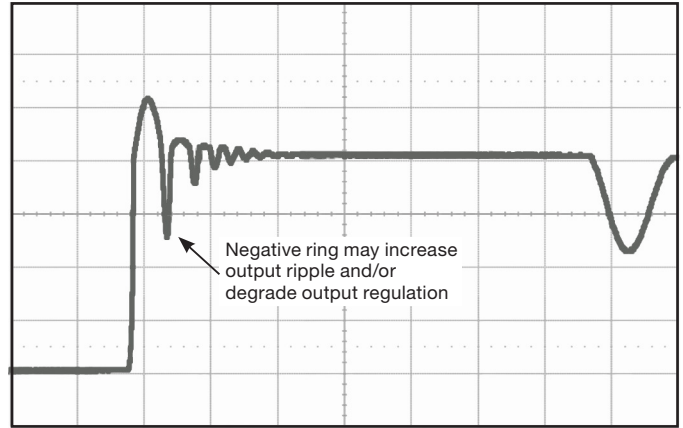

Figure 8. Undesirable Drain Voltage Waveform with Large Leakage Ring Undershoot.

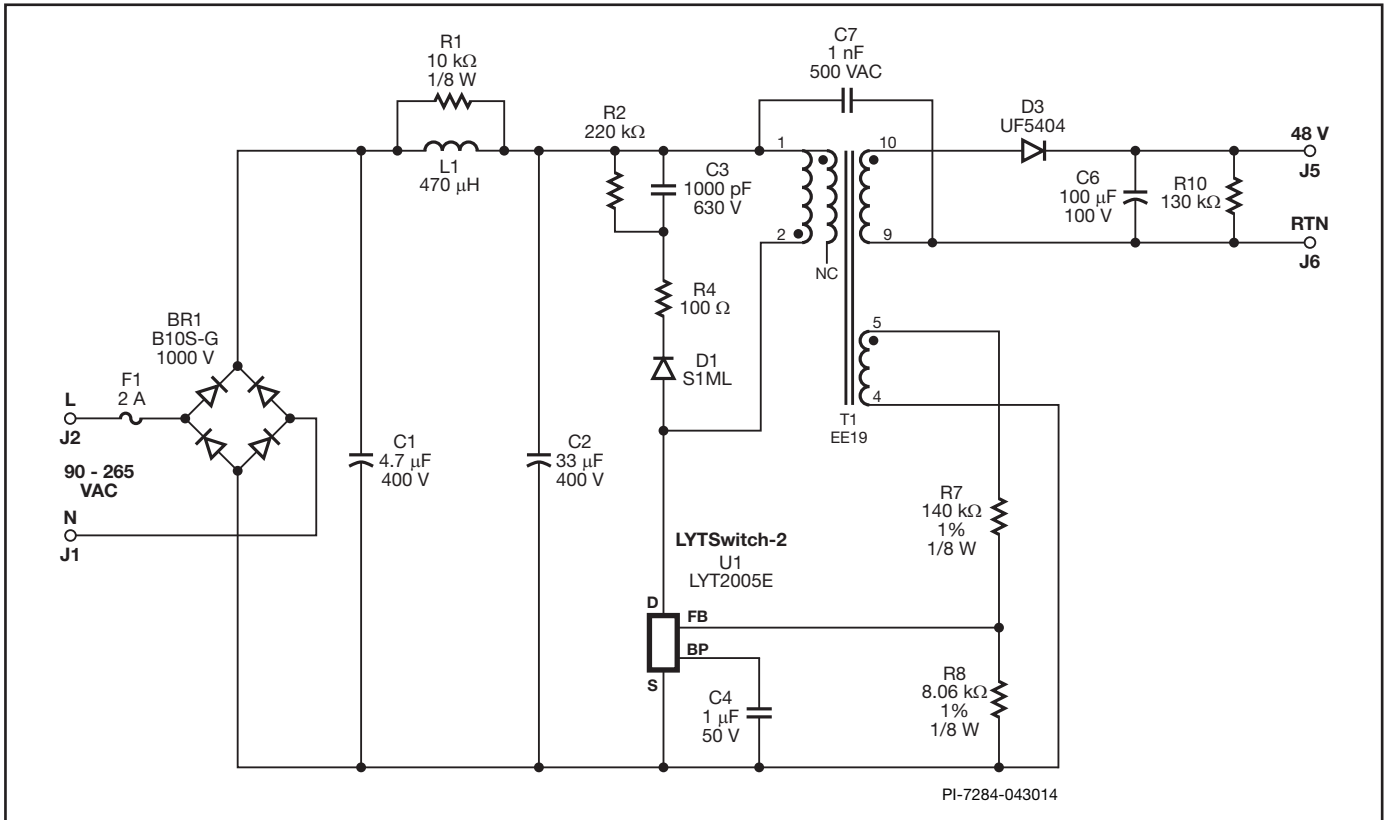

Figure 9. Example Schematic of LYTSwitch-2 Flyback Power Supply without Bias Supply.

## Quick Design Checklist

As with any power supply design, all LYTSwitch-2 family designs should be verified on the bench to make sure that component specifications are not exceeded under worst-case conditions. The following set of tests is strongly recommended:

1. Maximum drain voltage – Verify that the peak  $V_{DS}$  does not exceed 680 V at the highest input voltage and maximum output power.
2. Drain current – At maximum ambient temperature, maximum and minimum input voltage and maximum output load, review drain current waveforms at start-up for any signs of transformer saturation or excessive leading edge current spikes. LYTSwitch-2 devices have a leading edge blanking time to prevent premature termination of the ON-cycle, but limit leading edge spikes to less than the maximum time as specified in the data sheet.
3. Thermal check – At maximum output power, for both minimum and maximum input voltage and maximum ambient temperature; verify that temperature limits are not exceeded for LYTSwitch-2, transformer, output diodes and output capacitors. Thermal margin should be provided to allow for part-to-part variation in the  $R_{DS(ON)}$  of the LYTSwitch-2 device. For optimum regulation, a SOURCE pin temperature of 90 °C is recommended.

## Design Tools

Up-to-date information on design tools can be found at the Power Integrations web site: [www.power.com](http://www.power.com)



**Absolute Maximum Ratings<sup>(1,6)</sup>**

DRAIN Voltage .....	-0.3 V to 725 V
DRAIN Pin Peak Current <sup>(5)</sup> : LYT2001 .....	400 (600) mA <sup>(2)</sup>
LYT2002 .....	504 (750) mA <sup>(2)</sup>
LYT2003 .....	654 (980) mA <sup>(2)</sup>
LYT2004 .....	686 (1029) mA <sup>(2)</sup>
LYT2005 .....	784 (1176) mA <sup>(2)</sup>
Peak Negative Pulsed Drain Current .....	-100 mA <sup>(3)</sup>
FEEDBACK Pin Voltage .....	-0.3 to 9 V
FEEDBACK Pin Current.....	100 mA
BYPASS Pin Voltage .....	-0.3 to 9 V
Storage Temperature .....	-65 to 150 °C
Operating Junction Temperature <sup>(4)</sup> .....	-40 to 150 °C
Lead Temperature <sup>(5)</sup> .....	260 °C

**Notes:**

1. All voltages referenced to SOURCE, T<sub>A</sub> = 25 °C.
2. Higher peak Drain current allowed while Drain to Source voltage does not exceed 400 V.
3. Duration not to exceed 2 ms.
4. Normally limited by internal circuitry.
5. 1/16 in. from case for 5 seconds.
6. Absolute Maximum Ratings specified may be applied, one at a time without causing permanent damage to the product. Exposure to Absolute Maximum Ratings for extended periods of time may affect product reliability.

**Thermal Resistance**

Thermal Resistance: D Package:

(θ <sub>JA</sub> ) .....	100 °C/W <sup>(2)</sup> , 80 °C/W <sup>(3)</sup>
(θ <sub>JC</sub> ) <sup>(1)</sup> .....	30 °C/W
E Package	
(θ <sub>JA</sub> ) .....	105 °C/W <sup>(4)</sup>
(θ <sub>JC</sub> ) .....	2 °C/W <sup>(5)</sup>
K Package	
(θ <sub>JA</sub> ) .....	45 °C/W <sup>(6)</sup> , 38 °C/W <sup>(7)</sup>
(θ <sub>JC</sub> ) .....	2 °C/W <sup>(5)</sup>

**Notes:**

1. Measured on pin 8 (SOURCE) close to plastic interface.
2. Soldered to 0.36 sq. in. (232 mm<sup>2</sup>), 2 oz. (610 g/m<sup>2</sup>) copper clad.
3. Soldered to 1 sq. in. (645 mm<sup>2</sup>), 2 oz. (610 g/m<sup>2</sup>) copper clad.
4. Free standing with no heat sink.
5. Measured at the back surface of tab.
6. Soldered (including exposed pad for K package) to typical application PCB with a heat sinking area of 0.36 sq. in. (232 mm<sup>2</sup>), 2 oz. (610 g/m<sup>2</sup>) copper clad.
7. Soldered (including exposed pad for K package) to typical application PCB with a heat sinking area of 1 sq. in. (645 mm<sup>2</sup>), 2 oz. (610 g/m<sup>2</sup>) copper clad.

Parameter	Symbol	Conditions		Min	Typ	Max	Units
		SOURCE = 0 V; T <sub>J</sub> = 0 to 100 °C (Unless Otherwise Specified)					
<b>Control Functions</b>							
<b>Programmable Maximum Frequency</b>	f <sub>OSC</sub>	T <sub>J</sub> = 25 °C t <sub>ON</sub> × I <sub>FB</sub> = 1.4 mA-μs See Note A	V <sub>FB</sub> = V <sub>FBth</sub>			85	kHz
<b>Minimum Operation Frequency</b>	f <sub>OSC(MIN)</sub>	T <sub>J</sub> = 25 °C V <sub>FB</sub> = V <sub>FBth</sub>	LYT2001-2003	300	330	365	Hz
			LYT2004D/E/K	775	850	930	
			LYT2005	510	580	645	
<b>Frequency Ratio (Constant Current)</b>	f <sub>RATIO(CC)</sub>	T <sub>J</sub> = 25 °C Between V <sub>FB</sub> = 1.0 V and V <sub>FB</sub> = 1.6 V		1.550	1.593	1.635	
<b>Frequency Ratio (Inductance Correction)</b>	f <sub>RATIO(IC)</sub>	Between t <sub>ON</sub> × I <sub>FB</sub> = 1.4 mA and t <sub>ON</sub> × I <sub>FB</sub> = 2 mA-μs		1.160	1.210	1.260	
<b>Frequency Jitter</b>		Peak-to-Peak Jitter Compared to Average Frequency, T <sub>J</sub> = 25 °C			±7		%

Parameter	Symbol	Conditions		Min	Typ	Max	Units
		SOURCE = 0 V; T <sub>J</sub> = 0 to 100 °C (Unless Otherwise Specified)					
<b>Control Functions (cont.)</b>							
Maximum Duty Cycle	DC <sub>MAX</sub>	See Notes D, E			55		%
FEEDBACK Pin Voltage	V <sub>FB(TH)</sub>	C <sub>BP</sub> = 1 μF	T <sub>J</sub> = 25 °C	1.915	1.940	1.965	V
			T <sub>J</sub> = 100 °C See Note E	1.90	1.94	1.98	
FEEDBACK Pin Voltage at Turn-Off Threshold	V <sub>FB(AR)</sub>			0.69	0.75	0.81	V
Minimum Switch ON-Time	t <sub>ON(MIN)</sub>	See Note E			700		ns
FEEDBACK Pin Sampling Delay	t <sub>FB</sub>	T <sub>J</sub> = 25 °C		2.35	2.55	2.75	μs
DRAIN Pin Supply Current	I <sub>S1</sub>	FB Voltage > V <sub>FBth</sub> (MOSFET Not Switching)			320	370	μA
	I <sub>S2</sub>	FB Voltage = V <sub>FBth</sub> -0.1 V, Switch ON-Time = t <sub>ON</sub> (MOSFET Switching at f <sub>OSC</sub> )	LYT2001		440		μA
			LYT2002		500	560	
			LYT2003		550	600	
			LYT2004		600	680	
		LYT2005		700	800		
BYPASS Pin Charge Current	I <sub>CH1</sub>	V <sub>BP</sub> = 0 V	LYT2001		-3.4		mA
			LYT2002	-7.0	-4.8	-2.5	
			LYT2003	-7.2	-5.8	-3.2	
			LYT2004	-8.5	-6.3	-3.2	
			LYT2005	-8.5	-6.3	-3.2	
	I <sub>CH2</sub>	V <sub>BP</sub> = 4 V	LYT2001		-2.3		
			LYT2002	-5.6	-3.2	-1.4	
			LYT2003	-5.6	-4.0	-2.0	
			LYT2004	-6.0	-4.4	-2.0	
			LYT2005	-6.0	-4.4	-2.0	
BYPASS Pin Voltage	V <sub>BP</sub>			5.65	5.9	6.25	V
BYPASS Pin Voltage Hysteresis	V <sub>BPH</sub>			0.70	0.95	1.20	V
BYPASS Pin Shunt Voltage	V <sub>SHUNT</sub>			6.2	6.4	6.8	V

Parameter	Symbol	Conditions SOURCE = 0 V; T <sub>J</sub> = 0 to 100 °C (Unless Otherwise Specified)	Min	Typ	Max	Units	
<b>Circuit Protection</b>							
<b>Current Limit</b>	I <sub>LIMIT</sub>	V <sub>BP</sub> = 5.9 V T <sub>J</sub> = 25 °C	LYT2001D di/dt = 60 mA/μs		250		mA
			LYT2002D di/dt = 80 mA/μs	293	315	337	
			LYT2003D di/dt = 100 mA/μs	363	390	417	
			LYT2004D di/dt = 105 mA/μs	390	420	450	
			LYT2004E/K di/dt = 125 mA/μs	460	495	530	
			LYT2005E/K di/dt = 135 mA/μs	511	550	589	
<b>Minimum Current Limit Scale Factor</b>	I <sub>LIMIT(MIN)</sub>	T <sub>J</sub> = 25 °C	0.28	0.32	0.39		
<b>Normalized Output Current</b>	I <sub>O</sub>	T <sub>J</sub> = 25 °C	0.975	1.000	1.025		
<b>Leading Edge Blanking Time</b>	t <sub>LED</sub>	T <sub>J</sub> = 25 °C See Note E	170	215		ns	
<b>Thermal Shutdown Temperature</b>	T <sub>SD</sub>	See Note E	135	142	150	°C	
<b>Thermal Shutdown Hysteresis</b>	T <sub>SDH</sub>	See Note E		60		°C	
<b>Output</b>							
<b>ON-State Resistance</b>	R <sub>DS(ON)</sub>	LYT2001D I <sub>D</sub> = 50 mA	T <sub>J</sub> = 25 °C		24		Ω
			T <sub>J</sub> = 100 °C		36		
		LYT2002D I <sub>D</sub> = 63 mA	T <sub>J</sub> = 25 °C		13	15.5	
			T <sub>J</sub> = 100 °C		20	23.5	
		LYT2003D I <sub>D</sub> = 78 mA	T <sub>J</sub> = 25 °C		8	9.2	
			T <sub>J</sub> = 100 °C		12	14	
		LYT2004D I <sub>D</sub> = 84 mA	T <sub>J</sub> = 25 °C		5	5.9	
			T <sub>J</sub> = 100 °C		7.5	8.60	
		LYT2004E/K I <sub>D</sub> = 99 mA	T <sub>J</sub> = 25 °C		5	5.9	
			T <sub>J</sub> = 100 °C		7.5	8.60	
		LYT2005E/K I <sub>D</sub> = 110 mA	T <sub>J</sub> = 25 °C		3.2	3.8	
			T <sub>J</sub> = 100 °C		4.6	5.40	

Parameter	Symbol	Conditions SOURCE = 0 V; $T_J = 0$ to $100$ °C (Unless Otherwise Specified)	Min	Typ	Max	Units
<b>Output (cont.)</b>						
<b>OFF-State Leakage</b>	$I_{DSS1}$	$V_{DS} = 560$ V $T_J = 125$ °C, See Note C			50	$\mu$ A
	$I_{DSS2}$	$V_{DS} = 375$ V $T_J = 50$ °C		15		
<b>Breakdown Voltage</b>	$BV_{DSS}$	$T_J = 25$ °C	725			V
<b>DRAIN Pin Supply Voltage</b>			50			V
<b>Auto-Restart ON-Time</b>	$t_{AR-ON}$	$t_{ON} \times I_{FB} = 1.4$ mA $\mu$ s $f_{OSC} = 12$ kHz $V_{FB} = 0$ See Notes A, E	100			ms
<b>Auto-Restart OFF-Time</b>	$t_{AR-OFF}$	See Note E	0.32			s
<b>Open-Loop FEEDBACK Pin Current Threshold</b>	$I_{OL}$	See Note E		-45		$\mu$ A
<b>Open-Loop ON-Time</b>		See Note E		1.4		ms

## NOTES:

- Auto-restart on-time is a function of switching frequency programmed by  $t_{on} \times I_{FB}$  and minimum frequency in CC mode.
- The current limit threshold is compensated to cancel the effect of current limit delay. As a result the output current stays constant across the input line range.
- $I_{DSS1}$  is the worst-case off-state leakage specification at 80% of  $BV_{DSS}$  and maximum operating junction temperature.  $I_{DSS2}$  is a typical specification under worst-case application conditions (rectified 265 VAC) for no-load consumption calculations.
- When the duty cycle exceeds  $DC_{MAX}$  the LYTSwitch-2 operates in on-time extension mode.
- This parameter is derived from characterization.

Typical Performance Characteristics

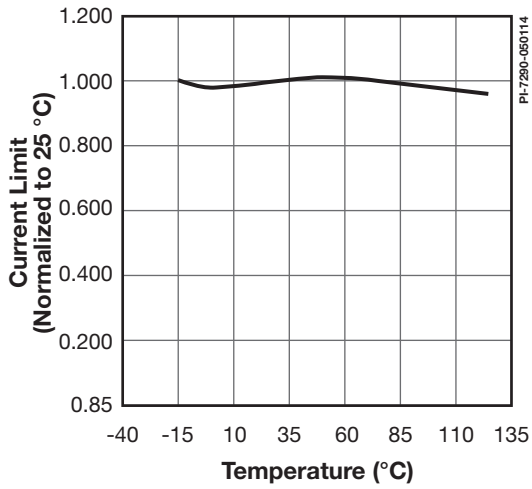

Figure 10. Current Limit vs. Temperature.

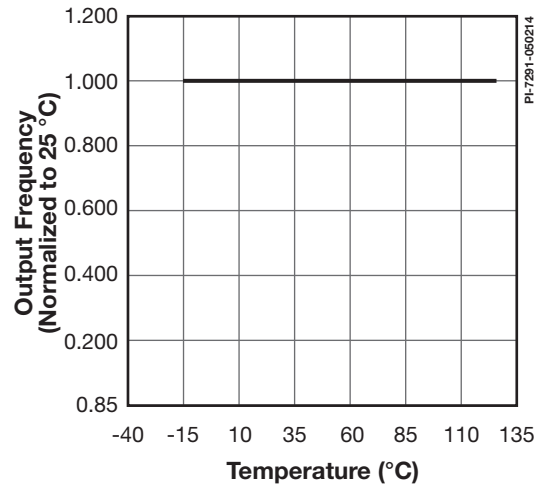

Figure 11. Output Frequency vs. Temperature.

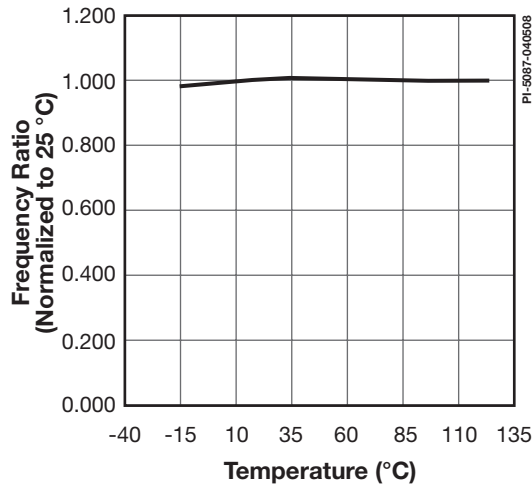

Figure 12. Frequency Ratio vs. Temperature (Constant Current).

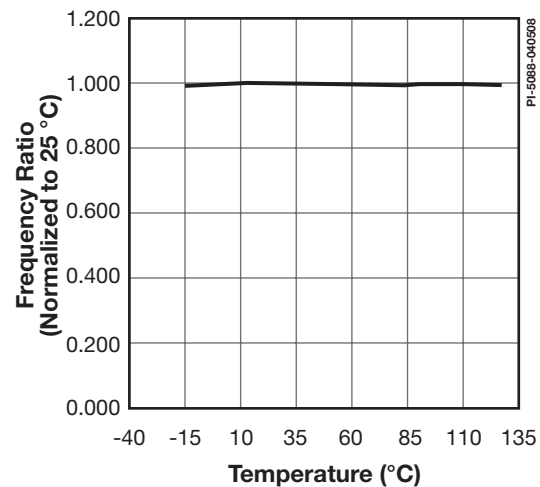

Figure 13. Frequency Ratio vs. Temperature (Inductor Current).

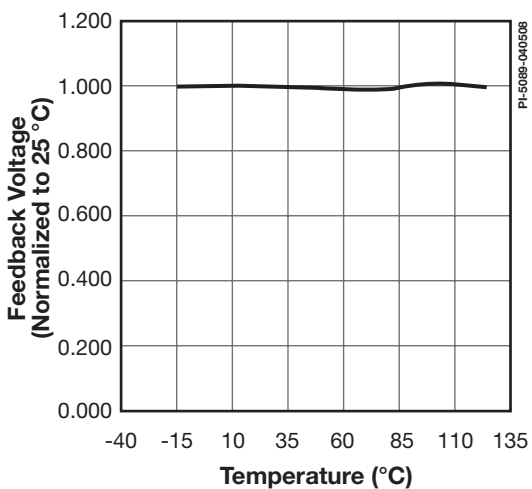

Figure 14. Feedback Voltage vs. Temperature.

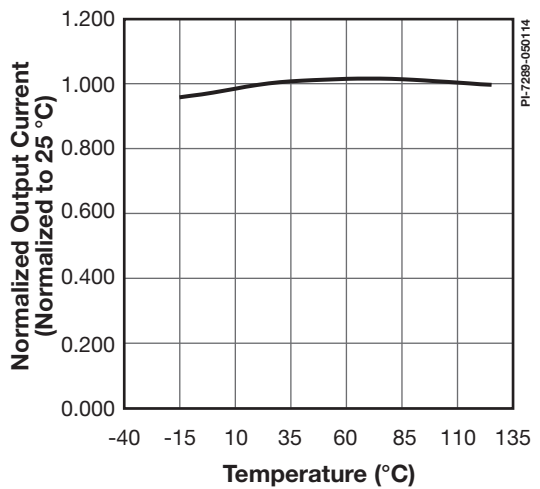

Figure 15. Normalized Output Current vs. Temperature.

Typical Performance Characteristics

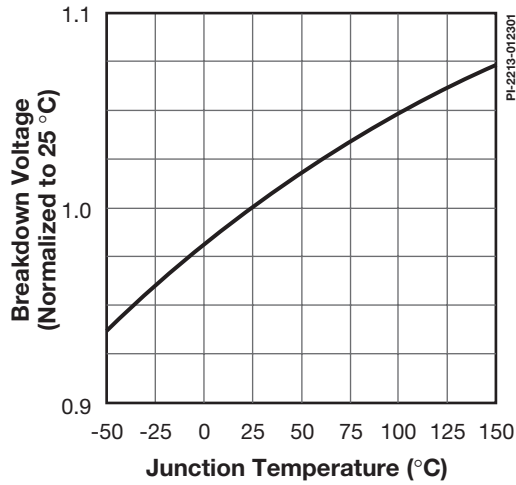

Figure 16. Breakdown vs. Temperature.

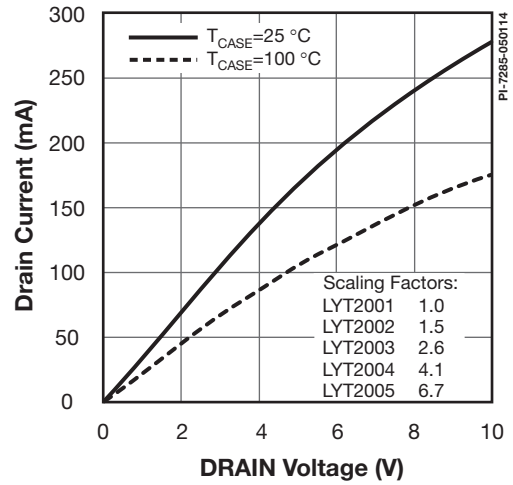

Figure 17. Output Characteristic.

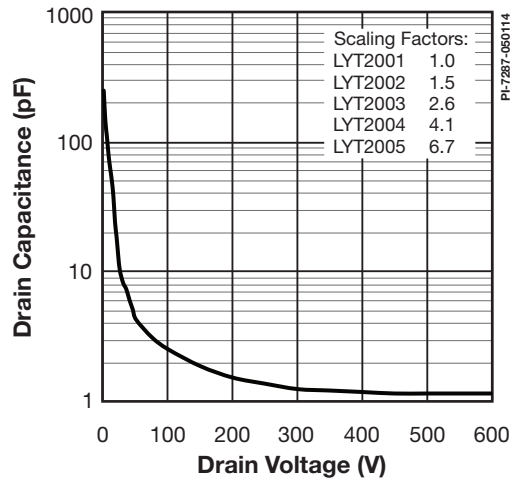

Figure 18.  $C_{oss}$  vs. Drain Voltage.

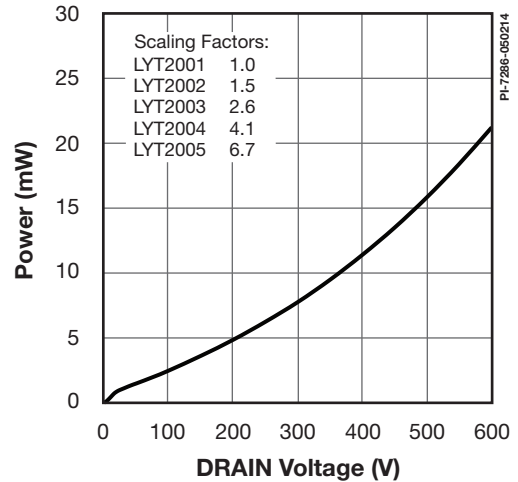
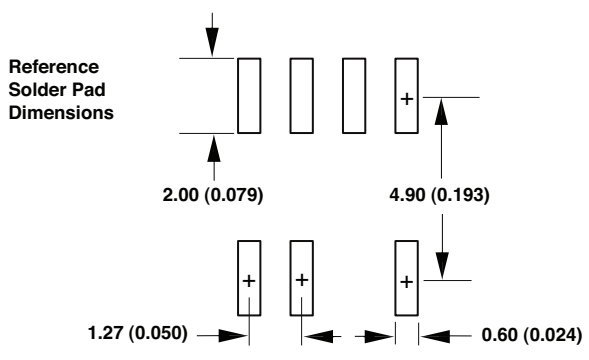
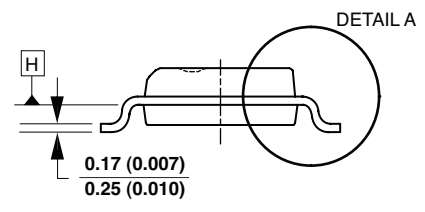
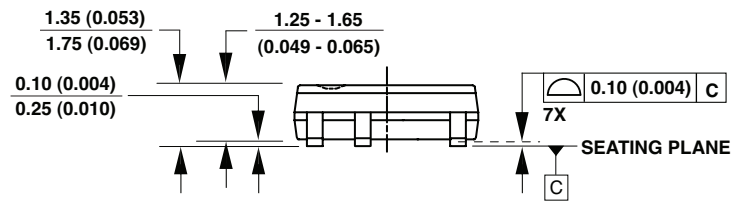
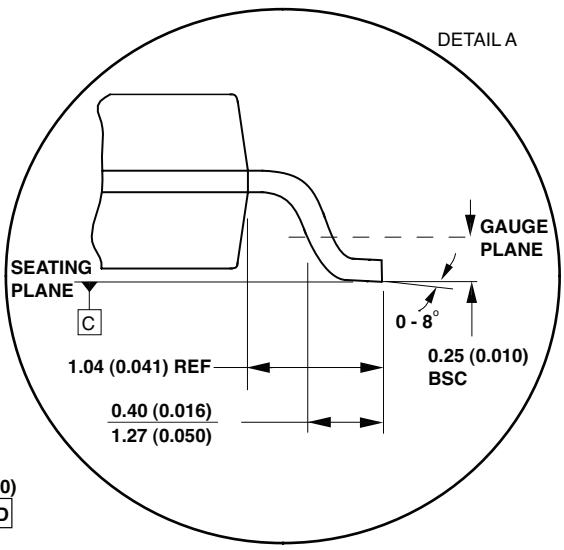
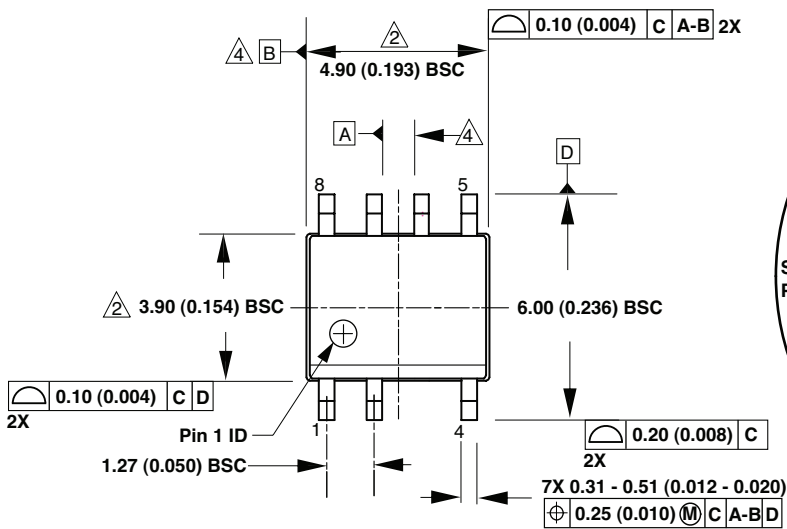

Figure 19. Drain Capacitance Power.

SO-8C (D Package)



- Notes:
1. JEDEC reference: MS-012.
  2. Package outline exclusive of mold flash and metal burr.
  3. Package outline inclusive of plating thickness.
  4. Datums A and B to be determined at datum plane H.
  5. Controlling dimensions are in millimeters. Inch dimensions are shown in parenthesis. Angles in degrees.

D07C

PI-4526-040110

eSIP-7C (E Package)

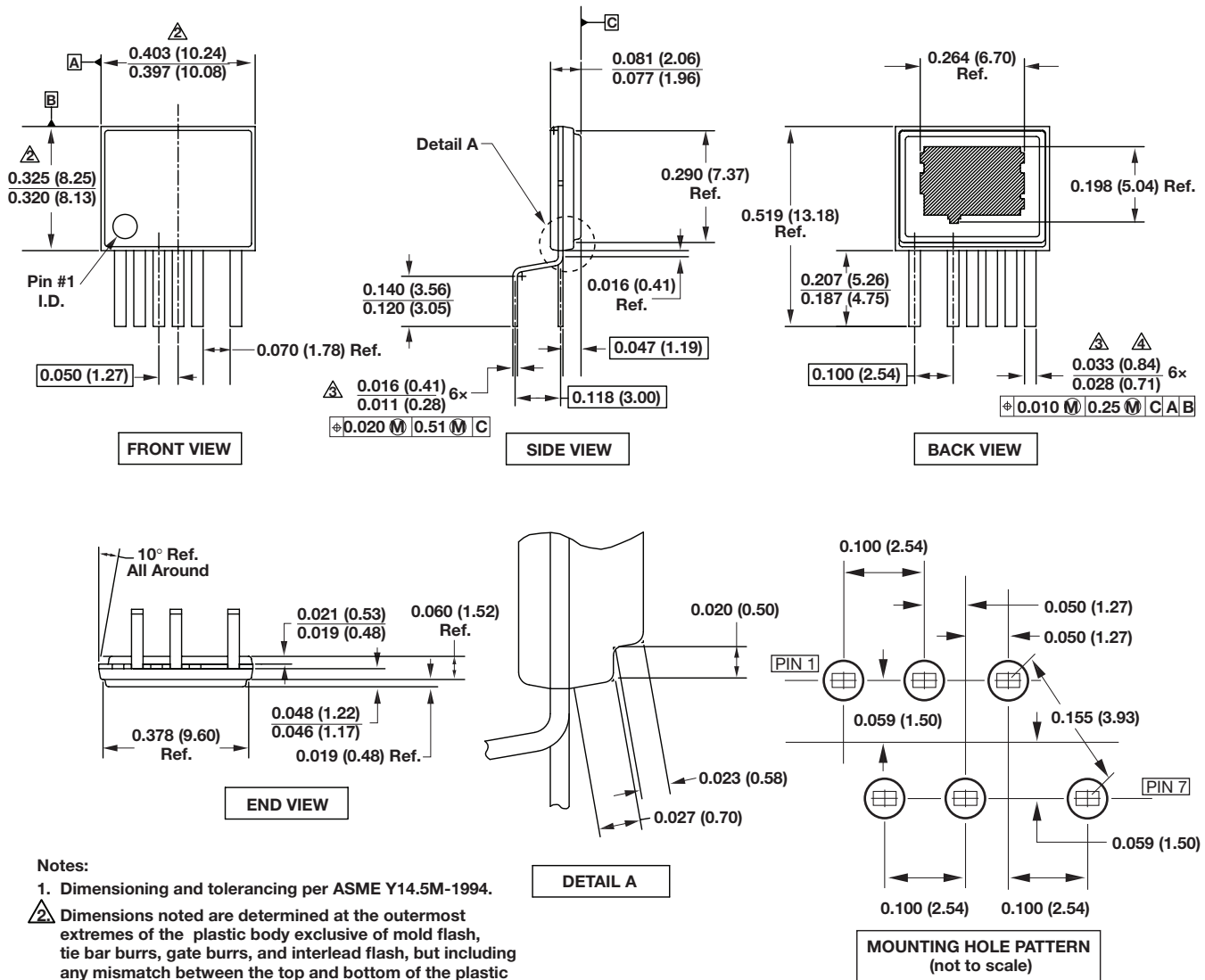

Notes:

1. Dimensioning and tolerancing per ASME Y14.5M-1994.
2. Dimensions noted are determined at the outermost extremes of the plastic body exclusive of mold flash, tie bar burrs, gate burrs, and interlead flash, but including any mismatch between the top and bottom of the plastic body. Maximum mold protrusion is 0.007 [0.18] per side.
3. Dimensions noted are inclusive of plating thickness.
4. Does not include inter-lead flash or protrusions.
5. Controlling dimensions in inches (mm).

PI-4917-061510



### eSOP-12B (K Package)

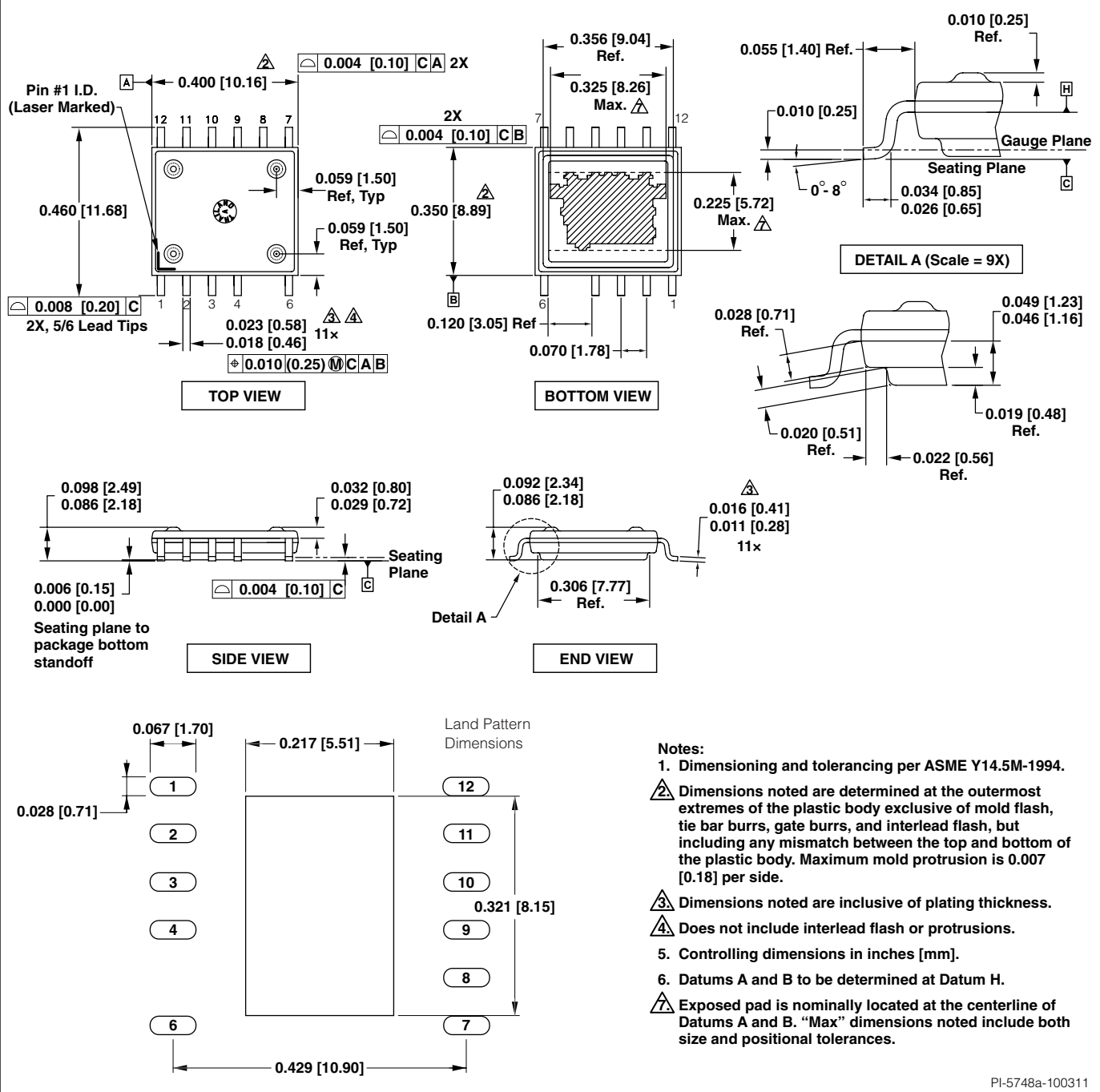

- Notes:**
1. Dimensioning and tolerancing per ASME Y14.5M-1994.
  2. Dimensions noted are determined at the outermost extremes of the plastic body exclusive of mold flash, tie bar burrs, gate burrs, and interlead flash, but including any mismatch between the top and bottom of the plastic body. Maximum mold protrusion is 0.007 [0.18] per side.
  3. Dimensions noted are inclusive of plating thickness.
  4. Does not include interlead flash or protrusions.
  5. Controlling dimensions in inches [mm].
  6. Datums A and B to be determined at Datum H.
  7. Exposed pad is nominally located at the centerline of Datums A and B. "Max" dimensions noted include both size and positional tolerances.

PI-5748a-100311

---

**Part Ordering Information**

---

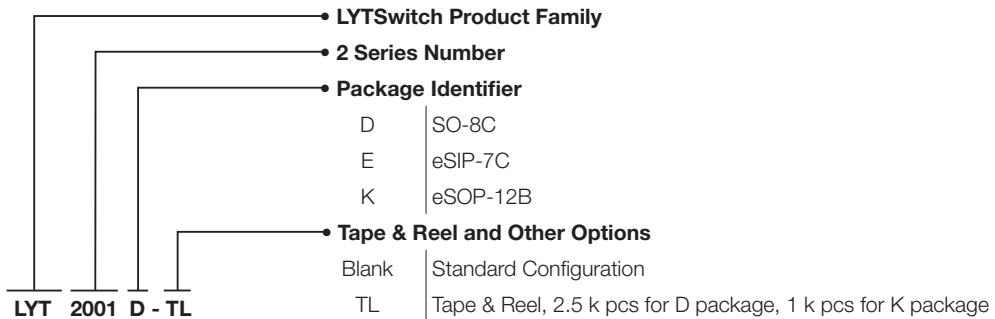



Revision	Notes	Date
A	Code A.	05/19/14
A	Updated Figure 2.	06/12/14
A	Updated $V_{FB(TH)}$ parameter table information.	12/08/14

### For the latest updates, visit our website: [www.power.com](http://www.power.com)

Power Integrations reserves the right to make changes to its products at any time to improve reliability or manufacturability. Power Integrations does not assume any liability arising from the use of any device or circuit described herein. POWER INTEGRATIONS MAKES NO WARRANTY HEREIN AND SPECIFICALLY DISCLAIMS ALL WARRANTIES INCLUDING, WITHOUT LIMITATION, THE IMPLIED WARRANTIES OF MERCHANTABILITY, FITNESS FOR A PARTICULAR PURPOSE, AND NON-INFRINGEMENT OF THIRD PARTY RIGHTS.

### Patent Information

The products and applications illustrated herein (including transformer construction and circuits external to the products) may be covered by one or more U.S. and foreign patents, or potentially by pending U.S. and foreign patent applications assigned to Power Integrations. A complete list of Power Integrations patents may be found at [www.power.com](http://www.power.com). Power Integrations grants its customers a license under certain patent rights as set forth at <http://www.power.com/ip.htm>.

### Life Support Policy

POWER INTEGRATIONS PRODUCTS ARE NOT AUTHORIZED FOR USE AS CRITICAL COMPONENTS IN LIFE SUPPORT DEVICES OR SYSTEMS WITHOUT THE EXPRESS WRITTEN APPROVAL OF THE PRESIDENT OF POWER INTEGRATIONS. As used herein:

1. A Life support device or system is one which, (i) is intended for surgical implant into the body, or (ii) supports or sustains life, and (iii) whose failure to perform, when properly used in accordance with instructions for use, can be reasonably expected to result in significant injury or death to the user.
2. A critical component is any component of a life support device or system whose failure to perform can be reasonably expected to cause the failure of the life support device or system, or to affect its safety or effectiveness.

The PI logo, TOPSwitch, TinySwitch, LinkSwitch, LYTSwitch, InnoSwitch, DPA-Switch, PeakSwitch, CAPZero, SENZero, LinkZero, HiperPFS, HiperTFS, HiperLCS, Qspeed, EcoSmart, Clampless, E-Shield, Filterfuse, FluxLink, StakFET, PI Expert and PI FACTS are trademarks of Power Integrations, Inc. Other trademarks are property of their respective companies. ©2014, Power Integrations, Inc.

## Power Integrations Worldwide Sales Support Locations

### World Headquarters

5245 Hellyer Avenue  
San Jose, CA 95138, USA.  
Main: +1-408-414-9200  
Customer Service:  
Phone: +1-408-414-9665  
Fax: +1-408-414-9765  
e-mail: [usasales@powerint.com](mailto:usasales@powerint.com)

### China (Shanghai)

Rm 2410, Charity Plaza, No. 88  
North Caoxi Road  
Shanghai, PRC 200030  
Phone: +86-21-6354-6323  
Fax: +86-21-6354-6325  
e-mail: [chinasales@powerint.com](mailto:chinasales@powerint.com)

### China (Shenzhen)

17/F, Hivac Building, No. 2, Keji  
Nan 8th Road, Nanshan District,  
Shenzhen, China, 518057  
Phone: +86-755-8672-8689  
Fax: +86-755-8672-8690  
e-mail: [chinasales@powerint.com](mailto:chinasales@powerint.com)

### Germany

Lindwurmstrasse 114  
80337 Munich  
Germany  
Phone: +49-895-527-39110  
Fax: +49-895-527-39200  
e-mail: [eurosales@powerint.com](mailto:eurosales@powerint.com)

### India

#1, 14th Main Road  
Vasanthanagar  
Bangalore-560052 India  
Phone: +91-80-4113-8020  
Fax: +91-80-4113-8023  
e-mail: [indiasales@powerint.com](mailto:indiasales@powerint.com)

### Italy

Via Milanese 20, 3rd. Fl.  
20099 Sesto San Giovanni (MI)  
Italy  
Phone: +39-024-550-8701  
Fax: +39-028-928-6009  
e-mail: [eurosales@powerint.com](mailto:eurosales@powerint.com)

### Japan

Kosei Dai-3 Bldg.  
2-12-11, Shin-Yokohama,  
Kohoku-ku  
Yokohama-shi Kanagawan  
222-0033 Japan  
Phone: +81-45-471-1021  
Fax: +81-45-471-3717  
e-mail: [japansales@powerint.com](mailto:japansales@powerint.com)

### Korea

RM 602, 6FL  
Korea City Air Terminal B/D, 159-6  
Samsung-Dong, Kangnam-Gu,  
Seoul, 135-728, Korea  
Phone: +82-2-2016-6610  
Fax: +82-2-2016-6630  
e-mail: [koreasales@powerint.com](mailto:koreasales@powerint.com)

### Singapore

51 Newton Road  
#19-01/05 Goldhill Plaza  
Singapore, 308900  
Phone: +65-6358-2160  
Fax: +65-6358-2015  
e-mail: [singaporesales@powerint.com](mailto:singaporesales@powerint.com)

### Taiwan

5F, No. 318, Nei Hu Rd., Sec. 1  
Nei Hu Dist.  
Taipei 11493, Taiwan R.O.C.  
Phone: +886-2-2659-4570  
Fax: +886-2-2659-4550  
e-mail: [taiwansales@powerint.com](mailto:taiwansales@powerint.com)

### UK

First Floor, Unit 15, Meadway  
Court, Rutherford Close,  
Stevenage, Herts. SG1 2EF  
United Kingdom  
Phone: +44 (0) 1252-730-141  
Fax: +44 (0) 1252-727-689  
e-mail: [eurosales@powerint.com](mailto:eurosales@powerint.com)

### Applications Hotline

World Wide +1-408-414-9660

### Applications Fax

World Wide +1-408-414-9760



Компания «ЭлектроПласт» предлагает заключение долгосрочных отношений при поставках импортных электронных компонентов на взаимовыгодных условиях!

Наши преимущества:

- Оперативные поставки широкого спектра электронных компонентов отечественного и импортного производства напрямую от производителей и с крупнейших мировых складов;
- Поставка более 17-ти миллионов наименований электронных компонентов;
- Поставка сложных, дефицитных, либо снятых с производства позиций;
- Оперативные сроки поставки под заказ (от 5 рабочих дней);
- Экспресс доставка в любую точку России;
- Техническая поддержка проекта, помощь в подборе аналогов, поставка прототипов;
- Система менеджмента качества сертифицирована по Международному стандарту ISO 9001;
- Лицензия ФСБ на осуществление работ с использованием сведений, составляющих государственную тайну;
- Поставка специализированных компонентов (Xilinx, Altera, Analog Devices, Intersil, Interpoint, Microsemi, Aeroflex, Peregrine, Syfer, Eurofarad, Texas Instrument, Miteq, Cobham, E2V, MA-COM, Hittite, Mini-Circuits, General Dynamics и др.);

Помимо этого, одним из направлений компании «ЭлектроПласт» является направление «Источники питания». Мы предлагаем Вам помощь Конструкторского отдела:

- Подбор оптимального решения, техническое обоснование при выборе компонента;
- Подбор аналогов;
- Консультации по применению компонента;
- Поставка образцов и прототипов;
- Техническая поддержка проекта;
- Защита от снятия компонента с производства.



#### Как с нами связаться

**Телефон:** 8 (812) 309 58 32 (многоканальный)

**Факс:** 8 (812) 320-02-42

**Электронная почта:** [org@eplast1.ru](mailto:org@eplast1.ru)

**Адрес:** 198099, г. Санкт-Петербург, ул. Калинина, дом 2, корпус 4, литера А.