



Series 218

Half Pitch, SMD DIP Switch

- Removable tape seal to withstand IR vapor phase or wave soldering temperatures, and board washing
- Gull-wing and “J” bend terminal configurations
- Low profile actuators prevent accidental actuation
- SPST configuration available
- 0.6mm/.024” actuator travel
- Optional top tape seal for board spray washing



Description

Positive detent separated from contactor causes contactor does not deflect during actuation. Unique compact type design allows to be used at mini size application. Optional sealed structure is optimized for board washing during soldering process. It makes it the ideal choice for any server, security and HVAC systems

Ordering Information

| Series | Number of Switch Positions | Low Profile Actuator | Bottom Epoxy Seal | Top Tape Seal | Terminal Type | Packaging Type | Actuation Preset |
|--------|----------------------------|----------------------|-------------------|---------------|---------------|----------------|------------------|
| 218- | 12 | LP | S | T | J | R | F |

| Code | No. of switch positions |
|------|-------------------------|
| 2 | 2 positions |
| 4 | 4 positions |
| 6 | 6 positions |
| 8 | 8 positions |
| 10 | 10 positions |
| 12 | 12 positions |

| Code | Top tape seal |
|-------|------------------|
| Blank | No top tape seal |
| T | Top tape seal |

| Code | Spec. |
|-------|----------------------------|
| Blank | Anti-static tube packaging |
| R | Tape & reel packaging |

| Code | Spec. |
|-------|--------------------|
| Blank | Gull wing terminal |
| J | J bend terminal |

| Code | Spec. |
|-------|----------------------|
| Blank | Ship at ON position |
| F | Ship at OFF position |

Notes: Contact CTS for other common features not listed.

Electrical Specifications

| Parameter | Conditions & Remarks | Min | Max | Unit |
|-----------------------|-----------------------------------|-----|-------|-----------|
| Circuit | SPST | 2 | 12 | position |
| Contact Resistance | Initial | | 100 | milliohms |
| | At end of life | | 100 | milliohms |
| Insulation Resistance | Between insulated terminals | 100 | | megohms |
| Dielectric Strength | 350 VAC between adjacent switches | | 1 | minute |
| Actuation Life | 25mA @ 24 VDC | | 1,000 | cycles |
| Switch Capacitance | Between adjacent closed switches | | 10 | pF |
| | | | 100 | mA |
| Nonswitching Rating | | | 50 | VDC |

Mechanical and Environmental

| | |
|-----------------------------|---|
| Soldering | Maximum reflow temperature, 250°C for 30 seconds |
| MSL | Level 1 |
| RoHS | Lead-Free. Fully compliant to RoHS Directive 2011/65/EU |
| Shock | Per MIL-STD-202G, method 213B, condition A(50G's) with no contact inconsistencies greater than 1 microsecond |
| Vibration | Per MIL-STD-202G, method 204D, condition B (.06" or 15G's between 10 HZ to 2K HZ) with no contact inconsistencies greater than 1 microsecond |
| Coplanarity | 0.1mm/.004" maximum |
| Seal | Bottom epoxy seal standard Top tape seal optional |
| Marking | Special marking available-consult CTS |
| Packaging: | Standard anti-static tube packaging Optional tape and reel packaging |
| Operating Temperature Range | -55°C to +85°C |
| Storage Temperature Range | -55°C to +85°C |

Soldering Profile

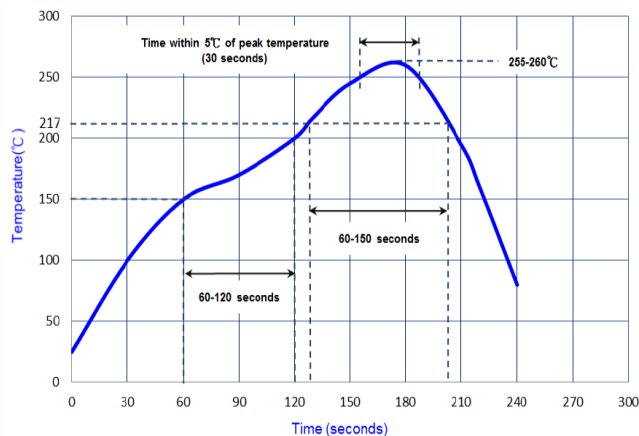

Mechanical Specifications

Figure 1 – Surface Mount J Bend Terminal

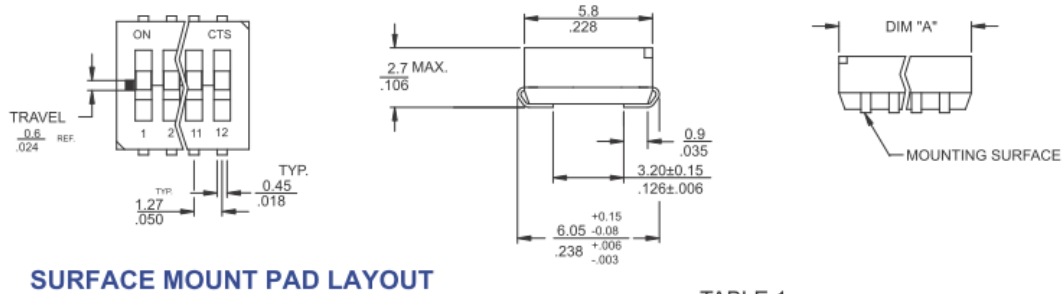

SURFACE MOUNT PAD LAYOUT

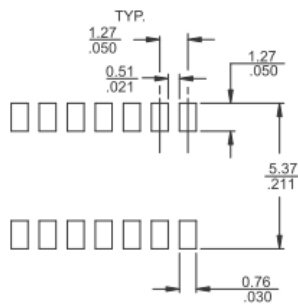
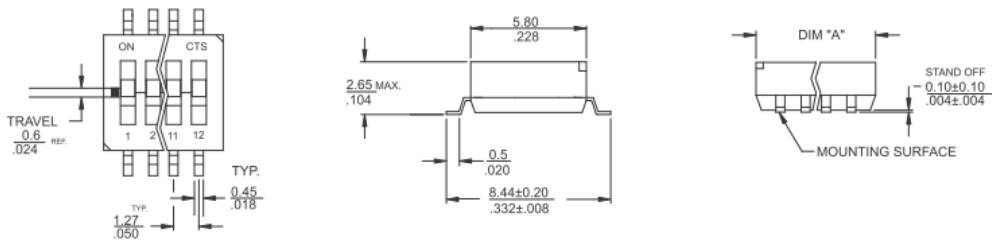

TABLE 1

| NO. OF SWITCH POSITIONS | "A" OVERALL DIMENSIONS |
|-------------------------|------------------------|
| 2 | 3.71/.146 |
| 4 | 6.25/.246 |
| 6 | 8.79/.346 |
| 8 | 11.33/.446 |
| 10 | 13.87/.546 |
| 12 | 16.41/.646 |

Figure 2 – Surface Mount Gull Wing Terminal



SURFACE MOUNT PAD LAYOUT

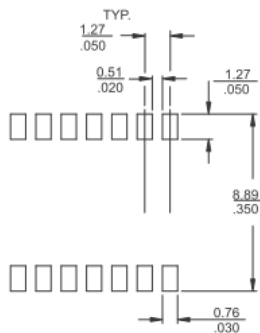

TABLE 2

| NO. OF SWITCH POSITIONS | "A" OVERALL DIMENSIONS |
|-------------------------|------------------------|
| 2 | 3.71/.146 |
| 4 | 6.25/.246 |
| 6 | 8.79/.346 |
| 8 | 11.33/.446 |
| 10 | 13.87/.546 |
| 12 | 16.41/.646 |

DIMENSION: $\frac{\text{mm}}{\text{inch}}$

Packing: Tape and Reel

Unit: mm

| SW Section | Fig | Bo | W | F |
|------------|-----|-------|------|-------|
| 2 | I | 4.51 | 16.0 | 7.50 |
| 4 | I | 7.05 | 16.0 | 7.50 |
| 6 | I | 9.75 | 16.0 | 7.50 |
| 8 | I | 12.13 | 24.0 | 11.50 |
| 10 | I | 14.67 | 24.0 | 11.50 |
| 12 | I | 17.22 | 24.0 | 11.50 |

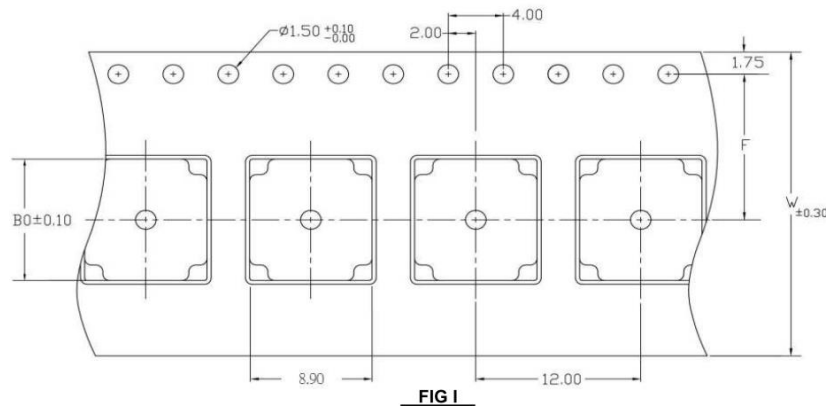

SPECIFIED REEL PARTS DIMENSIONS:

Unit: mm

| SW Section | W1 | W2 | W3 |
|------------|------|-----------|---------------------|
| 2 | 16.4 | 22.4 MAX. | 15.9 MIN./19.5 MAX. |
| 4 | 16.4 | 22.4 MAX. | 15.9 MIN./19.5 MAX. |
| 6 | 16.4 | 22.4 MAX. | 15.9 MIN./19.5 MAX. |
| 8 | 24.4 | 30.4 MAX. | 23.9 MIN./27.4 MAX. |
| 10 | 24.4 | 30.4 MAX. | 23.9 MIN./27.4 MAX. |
| 12 | 24.4 | 30.4 MAX. | 23.9 MIN./27.4 MAX. |

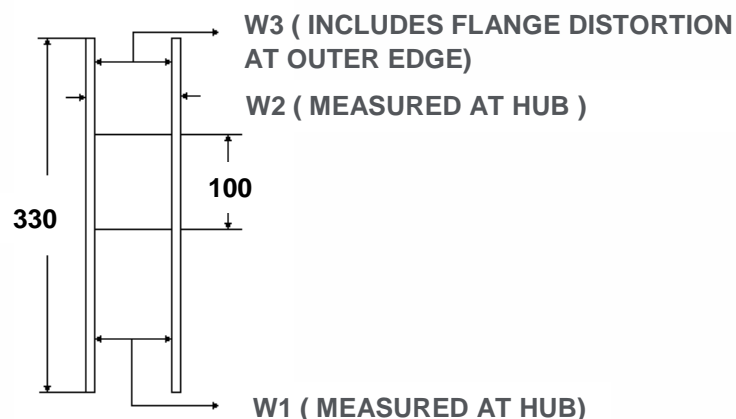

1. TAPE SPROCKET HOLE PITCH : $4.0 \pm 0.1\text{MM}$
ALL SMT ASSEMBLING MACHINES WILL PICK-UP THE COMPONENT FROM THE POINT, WHICH IS LOCATED IN THE CENTRE OF TWO ADJACENT SPROCKET HOLES IN FEEDING DIRECTION. THIS MUST BE TAKEK INTO ACCOUNT WHEN DESIGNING THE LOCATION OF THE COMPONENT IN T&R POCKET.
2. RECOMMENDED PART ORIENTATION IN TAPE & REEL POCKET.
ORIENT SWITCH TERMINAL #1 TO THE SIDE OF ROUND SPROCKET HOLES, SEE PICTURE BELOW.

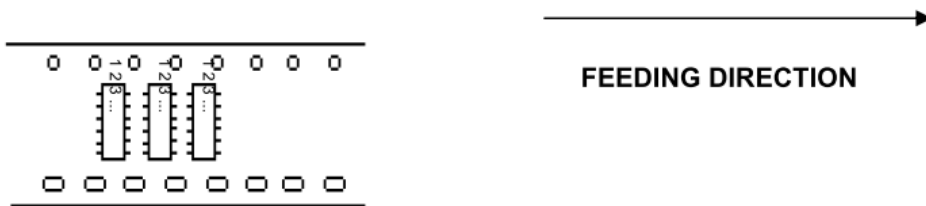

- 3 LENGTH OF TAPE
THERE SHALL BE A LEADER OF 400mm MINIMUM WHICH IS SEALED ONTO EMPTY CARRIER TAPE, SEE PICTURE BELOW.

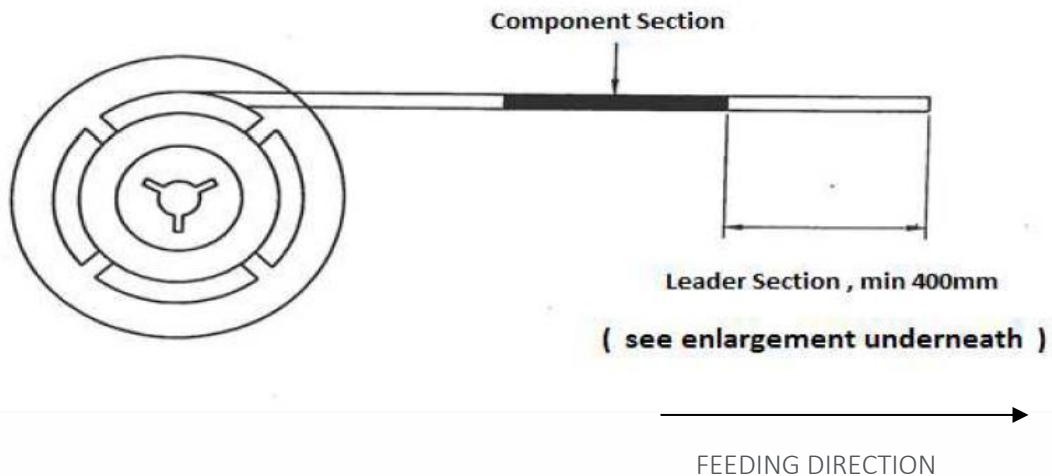

4. TAPE BREAK FORCE, PEEL STRENGTH AND ANGLE.
REQUIRED SETTINGS :
- TOP COVER TAPE PEEL FORCE : 10 ~ 130 gm
 - ANGLE BETWEEN THE TOP COVER TAPE AND THE DIRECTION OF FEED DURING PEEL OFF : 165°~ 180°

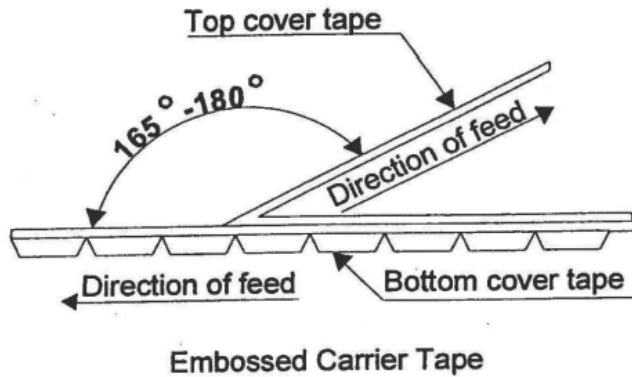

THE COVER TAPES MAY NOT EXTEND OVER THE EDGE OF THE CARRIER TAPE OR COVER ANY PART OF THE SPROCKETS HOLES.



Компания «ЭлектроПласт» предлагает заключение долгосрочных отношений при поставках импортных электронных компонентов на взаимовыгодных условиях!

Наши преимущества:

- Оперативные поставки широкого спектра электронных компонентов отечественного и импортного производства напрямую от производителей и с крупнейших мировых складов;
- Поставка более 17-ти миллионов наименований электронных компонентов;
- Поставка сложных, дефицитных, либо снятых с производства позиций;
- Оперативные сроки поставки под заказ (от 5 рабочих дней);
- Экспресс доставка в любую точку России;
- Техническая поддержка проекта, помощь в подборе аналогов, поставка прототипов;
- Система менеджмента качества сертифицирована по Международному стандарту ISO 9001;
- Лицензия ФСБ на осуществление работ с использованием сведений, составляющих государственную тайну;
- Поставка специализированных компонентов (Xilinx, Altera, Analog Devices, Intersil, Interpoint, Microsemi, Aeroflex, Peregrine, Syfer, Eurofarad, Texas Instrument, Miteq, Cobham, E2V, MA-COM, Hittite, Mini-Circuits, General Dynamics и др.);

Помимо этого, одним из направлений компании «ЭлектроПласт» является направление «Источники питания». Мы предлагаем Вам помощь Конструкторского отдела:

- Подбор оптимального решения, техническое обоснование при выборе компонента;
- Подбор аналогов;
- Консультации по применению компонента;
- Поставка образцов и прототипов;
- Техническая поддержка проекта;
- Защита от снятия компонента с производства.



Как с нами связаться

Телефон: 8 (812) 309 58 32 (многоканальный)

Факс: 8 (812) 320-02-42

Электронная почта: org@eplast1.ru

Адрес: 198099, г. Санкт-Петербург, ул. Калинина, дом 2, корпус 4, литера А.