

# ZB4BR4

red Ø60 mushroom pushbutton head Ø22  
spring return



## Main

Range of product	Harmony XB4
Product or component type	Head for non-illuminated pushbutton
Device short name	ZB4
Bezel material	Chromium plated metal
Mounting diameter	22 mm
Sale per indivisible quantity	1
Shape of signaling unit head	Round
Type of operator	Spring return
Operator profile	Red mushroom Ø 60 mm unmarked

## Complementary

Resistance to high pressure washer	At 55 °C ,distance: 0.1 m
Mechanical durability	5000000 cycles

## Environment

Protective treatment	TH
Ambient air temperature for storage	-40...70 °C
Ambient air temperature for operation	-25...70 °C
Class of protection against electric shock	Class I conforming to IEC 60536
IP degree of protection	IP66 conforming to IEC 60529
NEMA degree of protection	NEMA 13 NEMA 4X
IK degree of protection	IK03 conforming to IEC 50102
Standards	CSA C22-2 No 14 EN/IEC 60947-1 EN/IEC 60947-5-1 EN/IEC 60947-5-4 EN/IEC 60947-5-5 JIS C 4520 UL 508
Product certifications	BV CSA DNV (Det Norske Veritas) GL LROS (Lloyds register of shipping) RINA UL listed
Vibration resistance	5 gn (f = 2...500 Hz) conforming to IEC 60068-2-6
Shock resistance	30 gn for 18 ms half sine wave acceleration conforming to IEC 60068-2-27 50 gn for 11 ms half sine wave acceleration conforming to IEC 60068-2-27
RoHS EUR conformity date	0810
RoHS EUR status	Compliant

The information provided in this documentation contains general descriptions and/or technical characteristics of the performance of the products contained herein. This documentation is not intended as a substitute for and is not to be used for determining suitability or reliability of these products for specific user applications. It is the duty of any such user or integrator to perform the appropriate and complete risk analysis, evaluation and testing of the products with respect to the relevant specific application or use thereof. Neither Schneider Electric Industries SAS nor any of its affiliates or subsidiaries shall be responsible or liable for misuse of the information contained herein.

Dimensions of Heads for Spring Return Pushbuttons

Heads for Spring Return Pushbuttons

ZB4 BA•, ZB4 BA••

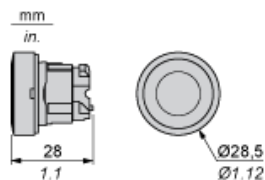

ZB4 BL•, ZB4 BL••

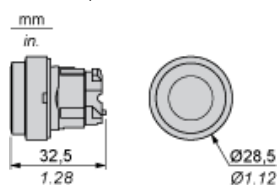

ZB4 BA•4, ZB4 BA•6

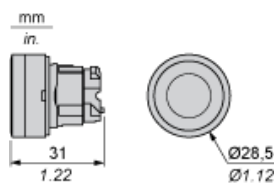

ZB4 BP••, ZB4 BP•S, ZB4 BP•83, ZB4 BP•

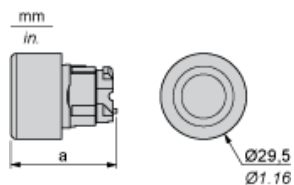

	a in mm	a in in.
ZB4 BP••	36.5	1.44
ZB4 BP•S	33	1.30
ZB4 BP•83	32	1.26
ZB4 BP•	35	1.38

Mushroom Heads for Spring Return Pushbuttons

ZB4 BC•4

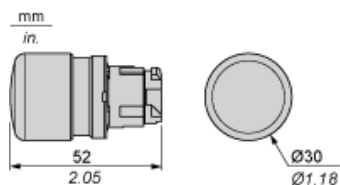

ZB4 BC•, ZB4 BR•

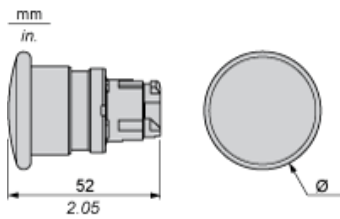

	Ø in mm	Ø in in.
ZB4 BC•	40	1.57
ZB4 BR•	60	2.36

ZB4 BR•16

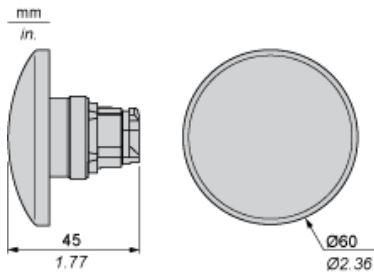

### Heads for Double-Headed, Spring Return Pushbuttons

ZB4 BA712•, ZB4 BA734•, ZB4 BA79

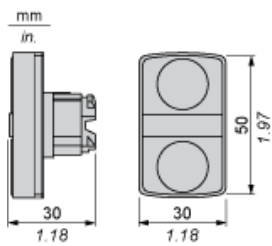

ZB4 BL734•

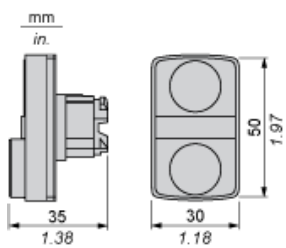

ZB4 BA712•, ZB4 BA734•, ZB4 BA79+ boot ZBA708

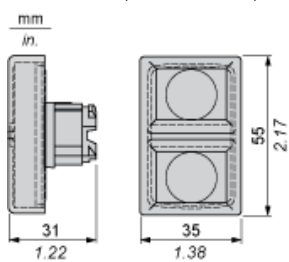

ZB4 BL734• + boot ZBA710

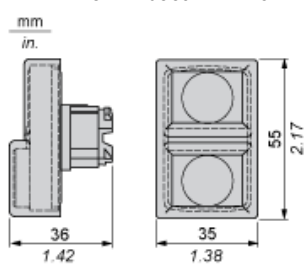

## Heads for Triple-Headed, Spring Return Pushbuttons

ZB4 BA7313\*, ZB4 BA711\*\*, ZB4 BA72124, ZB4 BA791

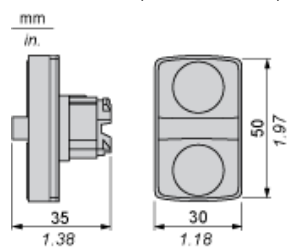

ZB4 BA7313\*, ZB4 BA711\*\*, ZB4 BA72124, ZB4 BA791 + boot ZBA709

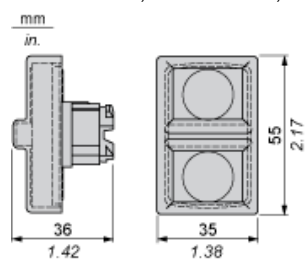

Panel Cut-out for Pushbuttons, Switches and Pilot Lights (Finished Holes, Ready for Installation)

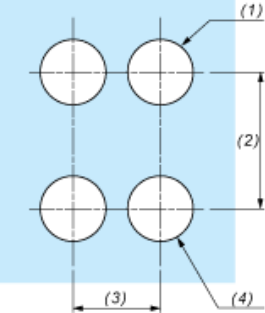
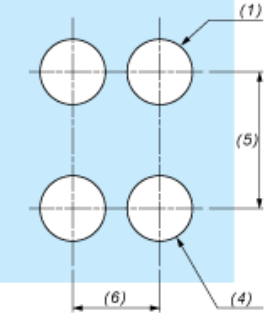
Connection by Screw Clamp Terminals or Plug-in Connectors or on Printed Circuit Board	Connection by Faston Connectors
	
<p>(1) Diameter on finished panel or support                  (2) 40 mm min. / 1.57 in. min.                  (3) 30 mm min. / 1.18 in. min.                  (4) <math>\varnothing 22.5 \text{ mm}</math> / 0.89 in. recommended (<math>\varnothing 22.3 \text{ mm}_0^{+0.4}</math> / <math>0.88 \text{ in.}_0^{+0.016}</math>)                  (5) 45 mm min. / 1.78 in. min.                  (6) 32 mm min. / 1.26 in. min.</p>	

Pushbuttons, Switches and Pilot Lights for Printed Circuit Board Connection

Panel Cut-outs (Viewed from Installer's Side)

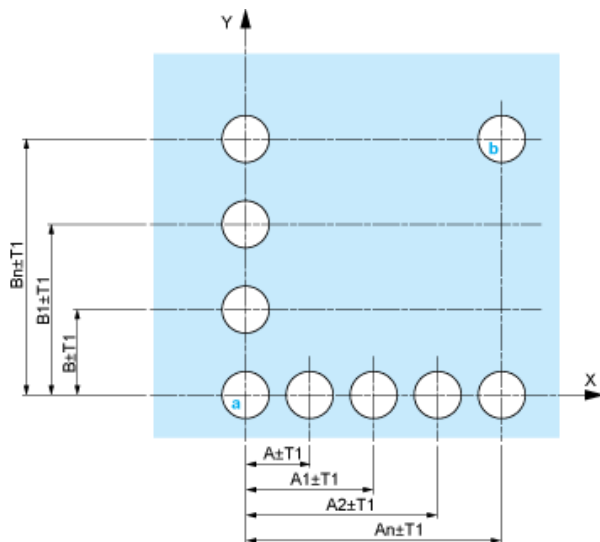

- A: 30 mm min. / 1.18 in. min.  
 B: 40 mm min. / 1.57 in. min.

# Printed Circuit Board Cut-outs (Viewed from Electrical Block Side)

Dimensions in mm

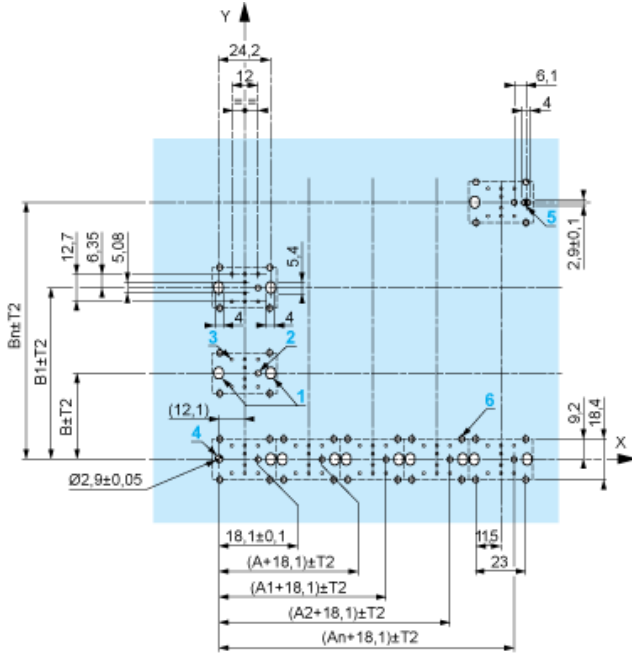

A: 30 mm min.  
B: 40 mm min.

Dimensions in in.

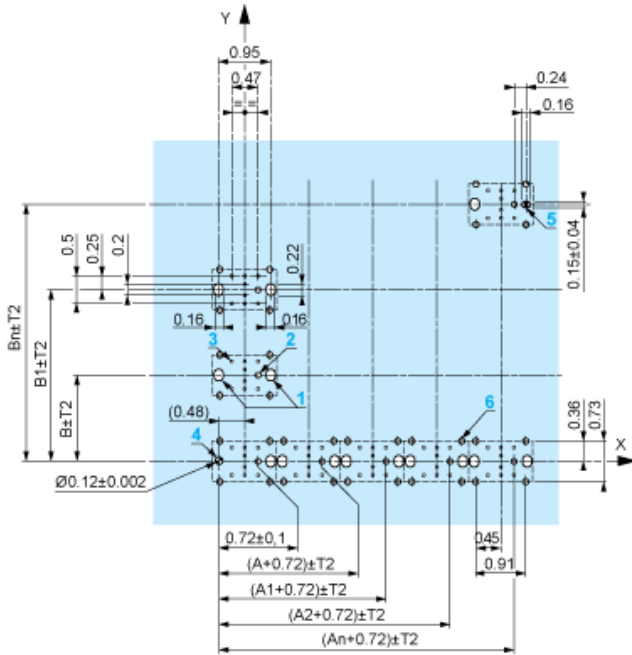

A: 1.18 in. min.  
B: 1.57 in. min.

## General Tolerances of the Panel and Printed Circuit Board

The cumulative tolerance must not exceed 0.3 mm / 0.012 in: T1 + T2 = 0.3 mm max.

## Installation Precautions

- Minimum thickness of circuit board: 1.6 mm / 0.06 in.
- Cut-out diameter: 22.4 mm ± 0.1 / 0.88 in. ± 0.004
- Orientation of body/fixing collar ZB4 BZ009: ± 2° 30' (excluding cut-outs marked a and b).
- Tightening torque of screws ZBZ 006: 0.6 N.m. max.
- Allow for one ZB4 BZ079 fixing collar/pillar and its fixing screws:
  - every 90 mm / 3.54 in. horizontally (X), and 120 mm / 4.72 in. vertically (Y).
  - with each selector switch head (ZB4 BD•, ZB4 BJ•, ZB4 BG•).

The fixing centers marked a and b are diagonally opposed and must align with those marked 4 and 5.

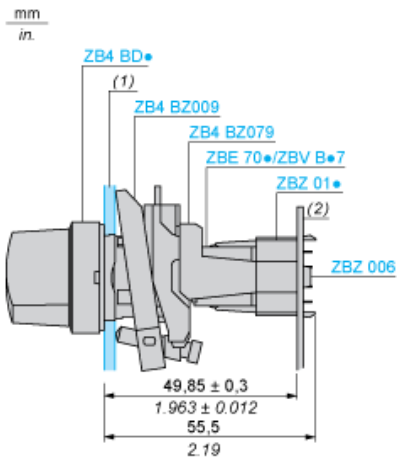

- (1) Panel  
(2) Printed circuit board

### Mounting of Adapter (Socket) ZBZ 01•

- 1 2 elongated holes for ZBZ 006 screw access
- 2 1 hole  $\varnothing 2.4 \text{ mm} \pm 0.05 / 0.09 \text{ in.} \pm 0.002$  for centring adapter ZBZ 01•
- 3  $8 \times \varnothing 1.2 \text{ mm} / 0.05 \text{ in.}$  holes
- 4 1 hole  $\varnothing 2.9 \text{ mm} \pm 0.05 / 0.11 \text{ in.} \pm 0.002$ , for aligning the printed circuit board (with cut-out marked a)
- 5 1 elongated hole for aligning the printed circuit board (with cut-out marked b)
- 6 4 holes  $\varnothing 2.4 \text{ mm} / 0.09 \text{ in.}$  for clipping in adapter ZBZ 01•

Dimensions An + 18.1 relate to the  $\varnothing 2.4 \text{ mm} \pm 0.05 / 0.09 \text{ in.} \pm 0.002$  holes for centring adapter ZBZ 01•.



Компания «ЭлектроПласт» предлагает заключение долгосрочных отношений при поставках импортных электронных компонентов на взаимовыгодных условиях!

Наши преимущества:

- Оперативные поставки широкого спектра электронных компонентов отечественного и импортного производства напрямую от производителей и с крупнейших мировых складов;
- Поставка более 17-ти миллионов наименований электронных компонентов;
- Поставка сложных, дефицитных, либо снятых с производства позиций;
- Оперативные сроки поставки под заказ (от 5 рабочих дней);
- Экспресс доставка в любую точку России;
- Техническая поддержка проекта, помощь в подборе аналогов, поставка прототипов;
- Система менеджмента качества сертифицирована по Международному стандарту ISO 9001;
- Лицензия ФСБ на осуществление работ с использованием сведений, составляющих государственную тайну;
- Поставка специализированных компонентов (Xilinx, Altera, Analog Devices, Intersil, Interpoint, Microsemi, Aeroflex, Peregrine, Syfer, Eurofarad, Texas Instrument, Miteq, Cobham, E2V, MA-COM, Hittite, Mini-Circuits, General Dynamics и др.);

Помимо этого, одним из направлений компании «ЭлектроПласт» является направление «Источники питания». Мы предлагаем Вам помощь Конструкторского отдела:

- Подбор оптимального решения, техническое обоснование при выборе компонента;
- Подбор аналогов;
- Консультации по применению компонента;
- Поставка образцов и прототипов;
- Техническая поддержка проекта;
- Защита от снятия компонента с производства.



#### Как с нами связаться

**Телефон:** 8 (812) 309 58 32 (многоканальный)

**Факс:** 8 (812) 320-02-42

**Электронная почта:** [org@eplast1.ru](mailto:org@eplast1.ru)

**Адрес:** 198099, г. Санкт-Петербург, ул. Калинина, дом 2, корпус 4, литера А.