



Wireless Global Limit Switch (EN 50041)

Limitless™ Switch

DESCRIPTION

The new Limitless™ product line combines the best of MICRO SWITCH™ global limit switches with the latest commercial off-the-shelf wireless technology. Wireless-enabled limit switches can now be used for position sensing and presence/absence detection for an endless number of applications.

The Limitless™ Series is especially beneficial for remote monitoring applications where wiring or wire maintenance is not physically possible or economically feasible. Combining this greater flexibility with proven harsh duty packaging can result in increased efficiencies and improved safety for machines, equipment, OEMs, and operators.

FEATURES

Wireless design

- Radio (license-free and global): WPAN 802.15.4, 2.4 GHz, point-to-point
- FCC 15, IC, ACMA & ETSI
- RoHS Compliant
- EMI Immunity
- Up to 304 m [1000 ft] communication range when used with a Limitless™ wireless monitor or receiver module (sold separately)
- Reliable, flexible, and secure wireless transmission
- Standard replaceable battery with ultra-low power consumption
- Direct or remote mount antenna options

Mechanical design

- EN50041 metal enclosure
- IP67; NEMA 1,4,12,13
- Full complement of operating heads and levers
- Modular construction of components
- Design for ease of installation

BENEFITS

- Enables presence/absence detection in remote parts of application / machinery, where wiring is an issue or not feasible
- Ability to reconfigure and network multiple switches, or point-to-point with personalized addresses, which allows for adding, subtracting or relocating Limitless™ switches easily
- Reduced installation/maintenance costs with no wires, conduit, strain relief, clips, connectors, connection boxes, etc.
- Eliminates issues with wire connection integrity on moving equipment
- Consumes ultra-low power to prolong battery life

POTENTIAL APPLICATIONS

- Valve position
- Crane boom/jib/skew position
- Lifts
- Material handling
- Presses
- Construction/Ag machines
- Conveyors
- Remote or temporary equipment
- Movable machinery
- Grain diverters or flaps
- Door position
- Hose attachment verification
- Specialty machines

Limitless™ Series

Description	Parameter
Series name	WGLA Series
Product type	Limitless™ Global Limit Switches
Availability	Global, license-free bands
Operating Characteristics	Reference wireless global limit switch specifications (WGLA Series)
Actuator	Side rotary, top plunger, top roller, top roller lever
Lever type	Rotary lever included w/side rotary– other lever options available
Housing material	Powder coated zinc die-cast
Housing type	EN 50041
Radio	WPAN 802.15.4; 2.4GHz
Antenna type	Direct or remote mount antenna options; Omni directional
Signal range	Nominal 304 m* for International use (Europe and Australia due to signal restrictions); Nominal 1000 ft* for use in US and Canada *clear line of sight between Limitless™ switch and monitor/receiver when using 2.2 dBi integral antenna
Battery	3.6 Vdc Lithium Thionyl Chloride; 2/3 AA size (Est. life >1yr) Manufactured by Uniwell, part number DEV-10-0009
Sealing	IP67; NEMA 1, 4, 12, 13
EMC	Latest applicable standards: EN 300 328, V1.7.1; EN 61326-1 (2006); EN 301 489-1, V1.8.1; EN 301 489-17, V2.1.1
Shock	IEC 60068-2-27; half sine, 10 g, 6 mS, 3 axis
Vibration	IEC 60068-2-6; 10-500Hz w/ 0,35 mm peak-to-peak, 58-500 Hz- 5g
Operating temperature	-40 °C to 85 °C [-40 °F to 185 °F] (side rotary) -25 °C to 85 °C [-13 °F to 185 °F] (all other housing styles)
Agency approvals and standards	FCC 15.247 Industry Canada RSS 210 ETSI, CE mark ACMA, C-Tick mark
UNSPSC code	20142601
UNSPSC commodity	20142601
Sealed	Industrial

* Actual range will vary depending upon antennas, cables, and site topography.

Wireless Limit Switches

NOMENCLATURE TREE (Not all configurations are immediately available.)

WGLA	1	A	00	A	A	1	A-	3	---
Switch type	Software version	RF Code	Antenna type code	Country use code	Head code	Lever code	Roller code mm [in]	Modification code	Specials
WGLA Series Wireless	1 Version 1	A 2.4 GHz; IEEE 802.15.4	00 No antenna; RP-SMA connector jack 01 2.2 dBi omni w/ switch mount; straight design 02 2.2 dBi omni w/ switch mount; tilt and swivel design 03 3.0 dBi omni w/ remote adhesive mount/9.8 ft cable 04 5.5 dBi omni w/ remote mag. mount, tilt&swivel/5 ft cable 05 5.5 dBi omni w/ remote mag. mount, tilt&swivel/10ft cable 06 9.0 dBi omni w/ remote mag. mount, tilt&swivel/5 ft cable 07 9.0 dBi omni w/ remote mag. mount, tilt&swivel/10ft cable 08 9.0 dBi omni w/ remote bkt. mount, str. design/3 ft cable 09 8.0 dBi omni w/ remote bkt. mount, str. design/11 ft cable 10 2.2 dBi omni w/ remote mag. mount, tilt&swivel/10 ft cable	A US, Canada B European Countries* C Australia	A Side rotary, momentary B Top pin plunger C Top roller plunger D Top roller lever	Not applicable 1 Std. fixed length 2 Adjustable roller 3 Yoke roller 4 Adjustable rod 5 Offset	Not applicable A 19 x 6.35 [0.75 x 0.25] nylon B 19 x 6.35 [0.75 x 0.25] steel D 38.1 x 6.35 [1.5 x 0.25] nylon J 200 mm aluminum adjustable rod K 140 mm aluminum adjustable rod N 318 mm stainless steel adjustable rod W 43.0 x 12.7 [1.5 x 0.5] rubber Y 50.8 x 12.7 [2.0 x 0.5] rubber T 19 x 8.76 [0.75 x 0.345] stainless steel	Not applicable 3 Head assembled with actuator to right side 4 Head assembled with actuator to left side 5 Head assembled with actuator to mounting surface 6 Roller perpendicular to mounting surface	Use only if switch has a special feature.

*Antenna type codes 00 - 03, 05, 10; usage also allowed in Country Codes A & C.

Monitor Nomenclature

WPMM	1	A	00	A	---
Monitor type	Software version	RF Code	Antenna type code	Country use code	Specials
WPMM Series Monitor	1 Version 1	A 2.4 GHz; IEEE 802.15.4	00 No antenna; RP-SMA connector jack 01 2.2 dBi omni with switch mount; straight design 02 2.2 dBi omni with switch mount; tilt and swivel design 03 3.0 dBi omni with remote adhesive mount/9.8 ft cable 04 5.5 dBi omni w/ remote mag. mount, tilt&swivel/5 ft cable 05 5.5 dBi omni w/ remote mag. mount, tilt&swivel/10ft cable 06 9.0 dBi omni w/ remote mag. mount, tilt&swivel/5 ft cable 07 9.0 dBi omni w/ remote mag. mount, tilt&swivel/10ft cable 08 8.0 dBi omni w/ remote bkt. mount, str. design/3 ft cable 09 8.0 dBi omni w/ remote bkt. mount, str. design/11 ft cable 10 2.2 dBi omni w/ remote mag. mount, tilt&swivel/10 ft cable	A US, Canada B European Countries* C Australia	Use only if monitor has a special feature.

*Antenna type codes 00-03, 05, 10; usage also allowed in country codes A & C.

Limitless™ Series

DIMENSIONS

Side Rotary Head with GLZ51 Series Lever

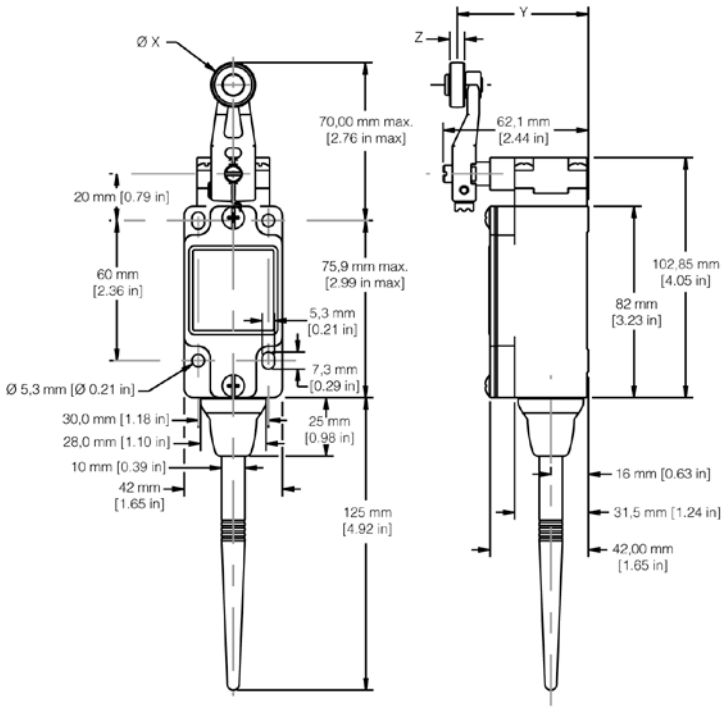

Lever	Roller Material	X Dim	Y Dim	Z Dim
GLZ51A	Nylon	19,1 mm [0.75 in]	55,9 mm [2.2 in]	6,4 mm [0.25 in]
GLZ51B	Steel	19,1 mm [0.75 in]	55,9 mm [2.2 in]	6,4 mm [0.25 in]
GLZ51T	Stainless Steel	19,1 mm [0.75 in]	56,8 mm [2.24 in]	8,8 mm [0.35 in]
GLZ51Y	Rubber	50,0 mm [1.97 in]	66,1 mm [2.60 in]	10,0 mm [0.39 in]

Side Rotary Head with GLZ52 Series Lever

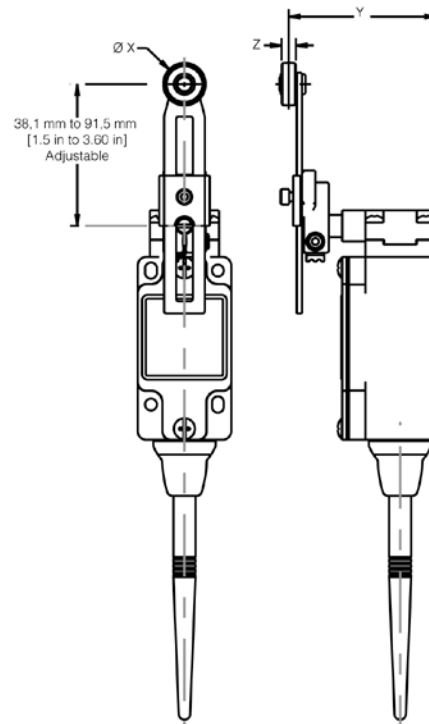

Lever	Roller Material	X Dim	Y Dim	Z Dim
GLZ52A	Nylon	19,1 mm [0.75 in]	65,9 mm [2.59 in]	6,4 mm [0.25 in]
GLZ52B	Steel	19,1 mm [0.75 in]	65,9 mm [2.59 in]	6,4 mm [0.25 in]
GLZ52D	Nylon	38,1 mm [1.5 in]	65,9 mm [2.59 in]	6,4 mm [0.25 in]
GLZ52E	Nylon	19,1 mm [0.75 in]	79,4 mm [3.13 in]	33,1 mm [1.30 in]
GLZ52W	Rubber	40,0 mm [1.57 in]	71,5 mm [2.81 in]	12,7 mm [0.5 in]
GLZ52Y	Rubber	50,0 mm [1.97 in]	68,8 mm [2.71 in]	10,0 mm [0.39 in]

Wireless Limit Switches

DIMENSIONS

Side Rotary Head with GLZ54 Series Lever

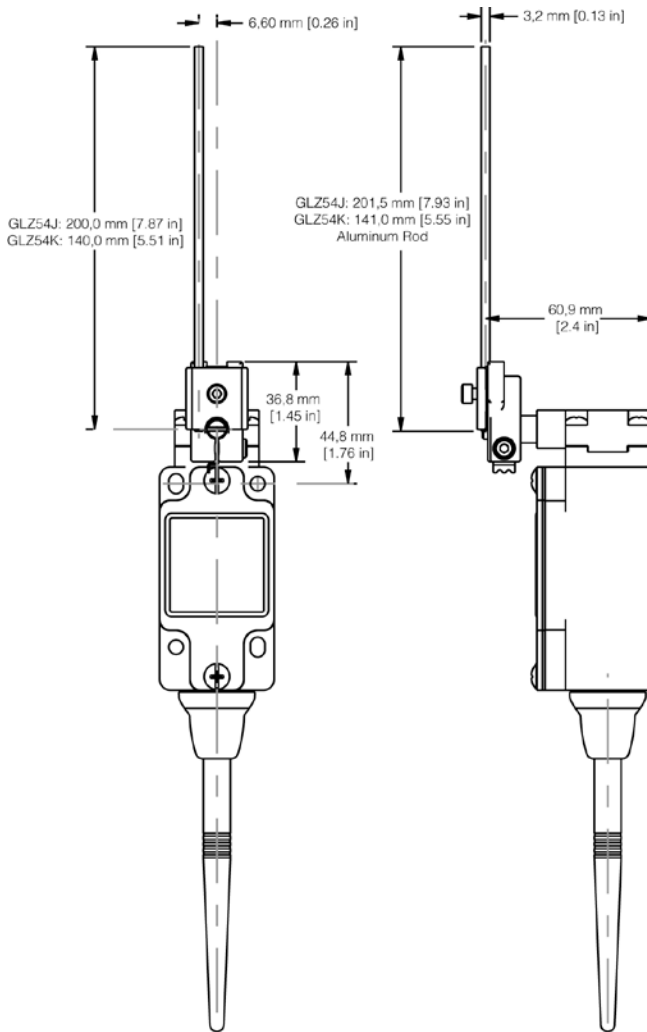

Top Pin Plunger Head

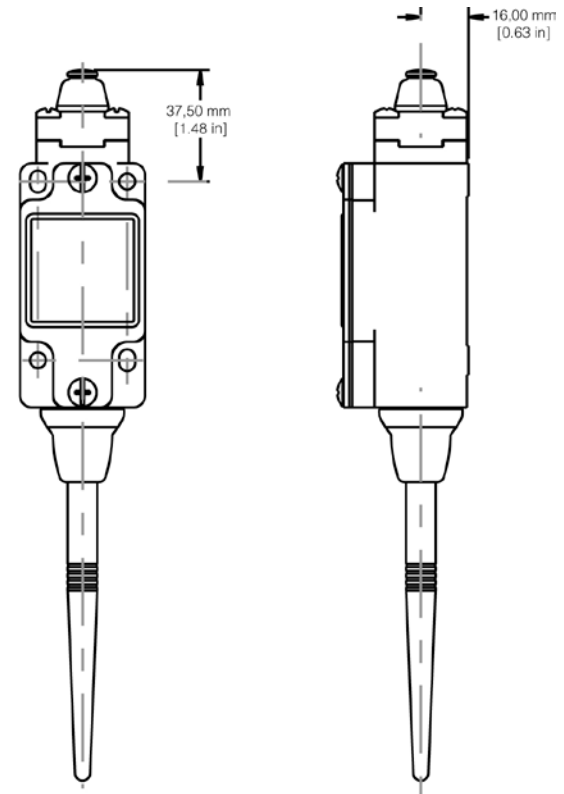

Limitless™ Series

STANDARD WGLA LISTINGS

Part Number	Description
WGLA1A01AA1A	Limitless™ Series WGLA Global Limit Switch, 2.2 dBi omni straight antenna, use in US/Canada, side rotary – momentary, standard lever with 19 mm x 6,35 mm [0.75 in x 0.25 in] nylon roller
WGLA1A01AA1B	Limitless™ Series WGLA Global Limit Switch, 2.2 dBi omni straight antenna, use in US/Canada, side rotary – momentary, standard lever with 19 mm x 6,35 mm [0.75 in x 0.25 in] steel roller
WGLA1A01AA4J	Limitless™ Series WGLA Global Limit Switch, 2.2 dBi omni straight antenna, use in US/Canada, side rotary – momentary, 200 mm aluminum adjustable rod actuator
WGLA1A01AB	Limitless™ Series WGLA Global Limit Switch, 2.2 dBi omni straight antenna, use in US/Canada, top pin plunger
WGLA1A01AC	Limitless™ Series WGLA Global Limit Switch, 2.2 dBi omni straight antenna, use in US/Canada, top roller plunger
WGLA1A01AD	Limitless™ Series WGLA Global Limit Switch, 2.2 dBi omni straight antenna, use in US/Canada, top roller lever
WGLA1A02AA1A	Limitless™ Series WGLA Global Limit Switch, 2.2 dBi omni tilt & swivel antenna, use in US/Canada, side rotary – momentary, standard lever with 19 mm x 6,35 mm [0.75 in x 0.25 in] nylon roller
WGLA1A02AA1B	Limitless™ Series WGLA Global Limit Switch, 2.2 dBi omni tilt & swivel antenna, use in US/Canada, side rotary – momentary, standard lever with 19 mm x 6,35 mm [0.75 in x 0.25 in] steel roller
WGLA1A02AA4J	Limitless™ Series WGLA Global Limit Switch, 2.2 dBi omni tilt & swivel antenna, use in US/Canada, side rotary – momentary, 200 mm aluminum adjustable rod actuator
WGLA1A02AB	Limitless™ Series WGLA Global Limit Switch, 2.2 dBi omni tilt & swivel antenna, use in US/Canada, top pin plunger
WGLA1A02AC	Limitless™ Series WGLA Global Limit Switch, 2.2 dBi omni tilt & swivel antenna, use in US/Canada, top roller plunger
WGLA1A02AD	Limitless™ Series WGLA Global Limit Switch, 2.2 dBi omni tilt & swivel antenna, use in US/Canada, top roller lever
WGLA1A04AA1A	Limitless™ Series WGLA Global Limit Switch, 5.5 dBi omni remote magnetic mount/tilt & swivel antenna with 5ft of cable, use in US/Canada, side rotary – momentary, standard lever with 19 mm x 6,35 mm [0.75 in x 0.25 in] nylon roller
WGLA1A04AA1B	Limitless™ Series WGLA Global Limit Switch, 5.5 dBi omni remote magnetic mount/tilt & swivel antenna with 5ft of cable, use in US/Canada, side rotary – momentary, standard lever with 19 mm x 6,35 mm [0.75 in x 0.25 in] steel roller
WGLA1A04AA4J	Limitless™ Series WGLA Global Limit Switch, 5.5 dBi omni remote magnetic mount/tilt & swivel antenna with 5ft of cable, use in US/Canada, side rotary – momentary, 200 mm aluminum adjustable rod actuator
WGLA1A04AB	Limitless™ Series WGLA Global Limit Switch, 5.5 dBi omni remote magnetic mount/tilt & swivel antenna with 5ft of cable, use in US/Canada, top pin plunger
WGLA1A04AC	Limitless™ Series WGLA Global Limit Switch, 5.5 dBi omni remote magnetic mount/tilt & swivel antenna with 5ft of cable, use in US/Canada, top roller plunger
WGLA1A04AD	Limitless™ Series WGLA Global Limit Switch, 5.5 dBi omni remote magnetic mount/tilt & swivel antenna with 5ft of cable, use in US/Canada, top roller lever

Wireless Limit Switches

ACCESSORIES NOMENCLATURE

Antenna Nomenclature

WAN	01	RSP	---																
Antenna type	Antenna type code	Connector Code	Specials																
WAN Series Antenna	<table border="1"> <tr> <td>01</td> <td>2.2 dBi omni; straight design</td> </tr> <tr> <td>02</td> <td>2.2 dBi omni; tilt & swivel des.</td> </tr> <tr> <td>03</td> <td>3.0 dBi omni with adhesive mount & 9.8 ft cable</td> </tr> <tr> <td>04</td> <td>5.5 dBi omni;*** tilt & swivel des.</td> </tr> <tr> <td>05</td> <td>9.0 dBi omni;*** tilt & swivel des.</td> </tr> <tr> <td>06</td> <td>8.0 dBi omni w/ bracket, straight des. 1 ft cable</td> </tr> </table>	01	2.2 dBi omni; straight design	02	2.2 dBi omni; tilt & swivel des.	03	3.0 dBi omni with adhesive mount & 9.8 ft cable	04	5.5 dBi omni;*** tilt & swivel des.	05	9.0 dBi omni;*** tilt & swivel des.	06	8.0 dBi omni w/ bracket, straight des. 1 ft cable	<table border="1"> <tr> <td>RNJ</td> <td>Reverse polarity N jack**</td> </tr> <tr> <td>RSP</td> <td>Reverse polarity SMA plug</td> </tr> </table>	RNJ	Reverse polarity N jack**	RSP	Reverse polarity SMA plug	Use only if antenna has a special feature.
01	2.2 dBi omni; straight design																		
02	2.2 dBi omni; tilt & swivel des.																		
03	3.0 dBi omni with adhesive mount & 9.8 ft cable																		
04	5.5 dBi omni;*** tilt & swivel des.																		
05	9.0 dBi omni;*** tilt & swivel des.																		
06	8.0 dBi omni w/ bracket, straight des. 1 ft cable																		
RNJ	Reverse polarity N jack**																		
RSP	Reverse polarity SMA plug																		

** Only used with 06 antenna type code
 *** Limited outdoor exposure. Protect against direct rain, salt, snow, ice, etc.

Limitless™ Antennas

WAN01RSP Straight Design Direct Mount Connector	WAN02RSP Tilt and Swivel Design, Direct Mount Antenna	WAN05RSP with WAMM100RSP-005 Tilt and Swivel Design, Magnetic Mount Antenna	WAN03RSP Flat Design, Adhesive Mount Antenna	WAN06RNJ Straight Design, Bracket Mount Antenna
				

Limitless™ Series

Cable Assembly Nomenclature



Limitless™ Cable Accessories

WCA200RNPRSP-002/010 Cable Assembly



Antenna Mounting Nomenclature



Limitless™ Panel Mount Accessories

WAMM100RSP-005/010 Magnetic Antenna Mount



Wireless Limit Switches

STANDARD ACCESSORIES

Part Number	Description
WAN03RSP	Flat wireless antenna with 3 dBi gain, reverse polarity SMA plug, adhesive mount with 10 ft of cable
WAN06RNJ	Straight wireless antenna with 8 dBi gain, reverse polarity N jack, bracket mount with 1 ft of cable
WAN01RSP	Straight wireless antenna with 2.2 dBi gain, reverse polarity SMA plug, connector mount (RP-SMA)
WAN02RSP	Tilt/swivel wireless antenna with 2.2 dBi gain, reverse polarity SMA plug, connector mount (RP-SMA)
WAN04RSP	Tilt/swivel wireless antenna with 5.5 dBi gain, reverse polarity SMA plug, connector mount (RP-SMA)
WAN05RSP	Tilt/swivel wireless antenna with 9 dBi gain, reverse polarity SMA plug, connector mount (RP-SMA)
WCA200RNPRSP-002	200 Series coax cable assembly, reverse polarity N plug, reverse polarity SMA plug, 2 ft of cable
WCA200RNPRSP-010	200 Series coax cable assembly, reverse polarity N plug, reverse polarity SMA plug, 10 ft of cable
WAMM100RSP-005	Magnetic antenna mounting, 100 Series coax cable, reverse polarity SMA plug with 5 ft of cable
WAMM100RSP-010	Magnetic antenna mounting, 100 Series coax cable, reverse polarity SMA plug with 10 ft of cable

WARNING

PERSONAL INJURY

DO NOT USE these products as safety or emergency stop devices or in any other application where failure of the product could result in personal injury.

Failure to comply with these instructions could result in death or serious injury.

WARNING

MISUSE OF DOCUMENTATION

- The information presented in this product sheet is for reference only. Do not use this document as a product installation guide.
- Complete installation, operation, and maintenance information is provided in the instructions supplied with each product.

Failure to comply with these instructions could result in death or serious injury.

WARNING

Honeywell does not recommend using devices for critical control applications where there is, or may be, a single point of failure or where single points of failure may result in an unsafe condition. It is up to the end-user to weigh the risks and benefits to determine if the products are appropriate for the application based on security, safety and performance. Additionally, it is up to the end-user to ensure that the control strategy results in a safe operating condition if any crucial segment of the control solution fails.

Failure to comply with these instructions could result in death or serious injury.

WARRANTY/REMEDY

Honeywell warrants goods of its manufacture as being free of defective materials and faulty workmanship. Honeywell's standard product warranty applies unless agreed to otherwise by Honeywell in writing; please refer to your order acknowledgement or consult your local sales office for specific warranty details. If warranted goods are returned to Honeywell during the period of coverage, Honeywell will repair or replace, at its option, without charge those items it finds defective. **The foregoing is buyer's sole remedy and is in lieu of all other warranties, expressed or implied, including those of merchantability and fitness for a particular purpose. In no event shall Honeywell be liable for consequential, special, or indirect damages.**

While we provide application assistance personally, through our literature and the Honeywell web site, it is up to the customer to determine the suitability of the product in the application.

Specifications may change without notice. The information we supply is believed to be accurate and reliable as of this printing. However, we assume no responsibility for its use.

SALES AND SERVICE

Honeywell serves its customers through a worldwide network of sales offices, representatives and distributors. For application assistance, current specifications, pricing or name of the nearest Authorized Distributor, contact your local sales office or:

E-mail: info.sc@honeywell.com

Internet: www.honeywell.com/sensing

Phone and Fax:

Asia Pacific	+65 6355-2828
	+65 6445-3033 Fax
Europe	+44 (0) 1698 481481
	+44 (0) 1698 481676 Fax
Latin America	+1-305-805-8188
	+1-305-883-8257 Fax
USA/Canada	+1-800-537-6945
	+1-815-235-6847
	+1-815-235-6545 Fax

Sensing and Control
Honeywell
1985 Douglas Drive North
Golden Valley, MN 55422
www.honeywell.com

002317-3-EN IL50 GLO Printed in USA
June 2010
Copyright © 2010 Honeywell International Inc. All rights reserved.

Honeywell



Компания «ЭлектроПласт» предлагает заключение долгосрочных отношений при поставках импортных электронных компонентов на взаимовыгодных условиях!

Наши преимущества:

- Оперативные поставки широкого спектра электронных компонентов отечественного и импортного производства напрямую от производителей и с крупнейших мировых складов;
- Поставка более 17-ти миллионов наименований электронных компонентов;
- Поставка сложных, дефицитных, либо снятых с производства позиций;
- Оперативные сроки поставки под заказ (от 5 рабочих дней);
- Экспресс доставка в любую точку России;
- Техническая поддержка проекта, помощь в подборе аналогов, поставка прототипов;
- Система менеджмента качества сертифицирована по Международному стандарту ISO 9001;
- Лицензия ФСБ на осуществление работ с использованием сведений, составляющих государственную тайну;
- Поставка специализированных компонентов (Xilinx, Altera, Analog Devices, Intersil, Interpoint, Microsemi, Aeroflex, Peregrine, Syfer, Eurofarad, Texas Instrument, Miteq, Cobham, E2V, MA-COM, Hittite, Mini-Circuits, General Dynamics и др.);

Помимо этого, одним из направлений компании «ЭлектроПласт» является направление «Источники питания». Мы предлагаем Вам помощь Конструкторского отдела:

- Подбор оптимального решения, техническое обоснование при выборе компонента;
- Подбор аналогов;
- Консультации по применению компонента;
- Поставка образцов и прототипов;
- Техническая поддержка проекта;
- Защита от снятия компонента с производства.



Как с нами связаться

Телефон: 8 (812) 309 58 32 (многоканальный)

Факс: 8 (812) 320-02-42

Электронная почта: org@eplast1.ru

Адрес: 198099, г. Санкт-Петербург, ул. Калинина, дом 2, корпус 4, литера А.