

# NCS2003/A, NCV2003, NCS20032, NCV20032, NCS20034, NCV20034



ON Semiconductor®

[www.onsemi.com](http://www.onsemi.com)

## Operational Amplifiers, High Slew Rate, Low Voltage, Rail-to-Rail Output

The NCS2003 family of op amps features high slew rate, low voltage operation with rail-to-rail output drive capability. The 1.8 V operation allows high performance operation in low voltage, low power applications. The fast slew rate and wide unity-gain bandwidth (5 MHz at 1.8 V) make these op amps suited for high speed applications. The low input offset voltage (4 mV max) allows the op amp to be used for current shunt monitoring. Additional features include no output phase reversal with overdriven inputs and ultra low input bias current of 1 pA.

The NCS2003 family is the ideal solution for a wide range of applications and products. The single channel NCS2003, dual channel NCS20032, and quad channel NCS20034 are available in a variety of compact and space-saving packages. The NCV prefix denotes that the device is AEC-Q100 Qualified and PPAP Capable.

### Features

- Unity Gain Bandwidth: 7 MHz at  $V_S = 5\text{ V}$
- Fast Slew Rate: 8 V/ $\mu\text{s}$  rising, 12.5 V/ $\mu\text{s}$  falling at  $V_S = 5\text{ V}$
- Rail-to-Rail Output
- No Output Phase Reversal for Over-Driven Input Signals
- Low Offset Voltage: 0.5 mV typical
- Low Input Bias Current: 1 pA typical
- NCV Prefix for Automotive and Other Applications Requiring Unique Site and Control Change Requirements; AEC-Q100 Qualified and PPAP Capable
- These Devices are Pb-Free, Halogen Free/BFR Free and are RoHS Compliant

### Applications

- Current Shunt Monitor
- Signal Conditioning
- Active Filter
- Sensor Buffer

### End Products

- Motor Control Drives
- Hard Drives
- Medical Devices
- White Goods and Air Conditioners

### MARKING DIAGRAMS



SOT23-5  
CASE 483  
(NCS/NCV2003)

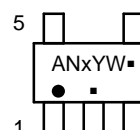

SOT553, 5 LEAD  
CASE 463B  
(NCS2003)



Micro8™  
DM SUFFIX  
CASE 846A

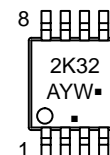

SOIC-8  
CASE 751

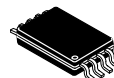
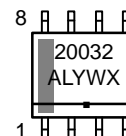

TSSOP-8  
T SUFFIX  
CASE 948S

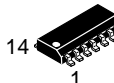
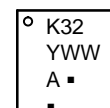

SOIC-14 NB  
CASE 751A

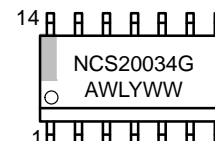

A = Assembly Location  
WL, L = Wafer Lot  
Y = Year  
WW, W = Work Week  
G or ■ = Pb-Free Package

(Note: Microdot may be in either location)

### ORDERING INFORMATION

See detailed ordering, marking and shipping information on page 2 of this data sheet.

# NCS2003/A, NCV2003, NCS20032, NCV20032, NCS20034, NCV20034

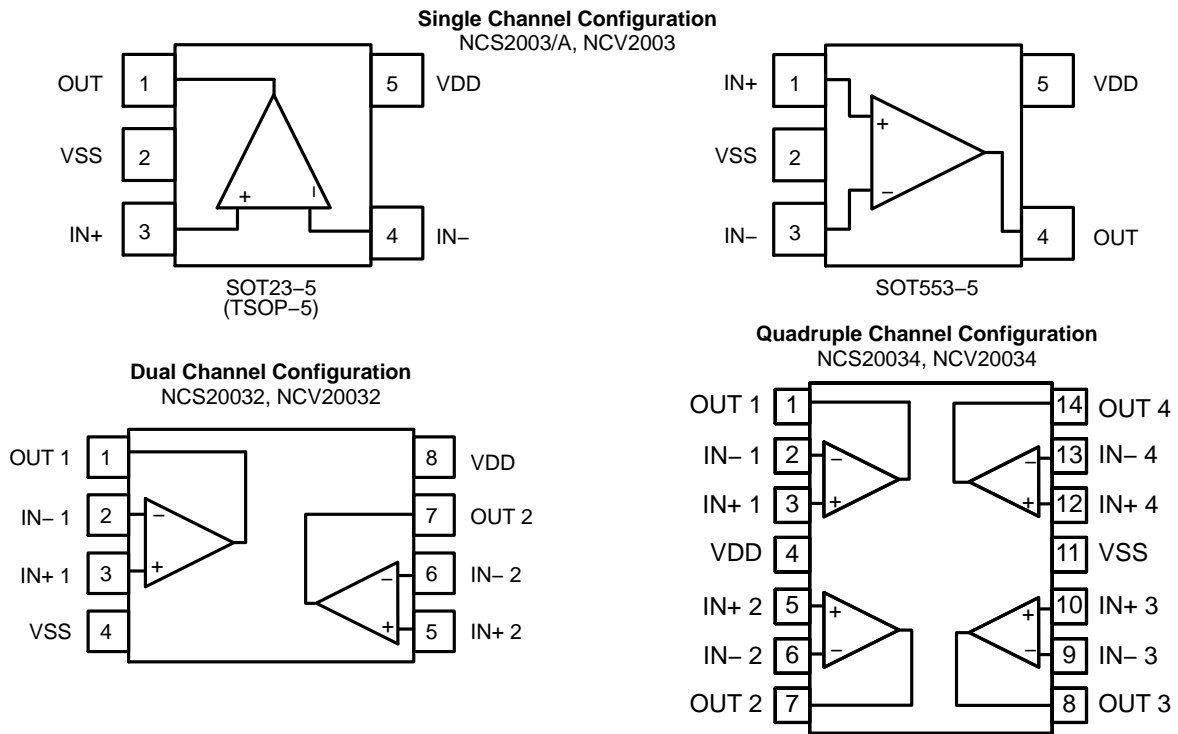

Figure 1. Pin Connections

## ORDERING INFORMATION

| Device                               | Configuration | Automotive | Marking   | Package               | Shipping†            |
|--------------------------------------|---------------|------------|-----------|-----------------------|----------------------|
| NCS2003SN2T1G                        | Single        | No         | AN3       | SOT23-5<br>(Pb-Free)  | 3000 / Tape and Reel |
| NCS2003ASN2T1G                       |               | No         | AN4       | SOT23-5<br>(Pb-Free)  | 3000 / Tape and Reel |
| NCS2003XV53T2G                       |               | No         | A3        | SOT553-5<br>(Pb-Free) | 4000 / Tape and Reel |
| NCV2003SN2T1G*                       |               | Yes        | AN3       | SOT23-5<br>(Pb-Free)  | 3000 / Tape and Reel |
| NCS20032DMR2G<br>(In Development)**  | Dual          | No         | 2K32      | Micro8<br>(Pb-Free)   | 4000 / Tape and Reel |
| NCS20032DR2G                         |               |            | 20032     | SOIC-8<br>(Pb-Free)   | 2500 / Tape and Reel |
| NCS20032DTBR2G<br>(In Development)** |               |            | K32       | TSSOP-8<br>(Pb-Free)  | 3000 / Tape and Reel |
| NCV20032DMR2G*<br>(In Development)** |               | Yes        | 2K32      | Micro8<br>(Pb-Free)   | 4000 / Tape and Reel |
| NCV20032DR2G*                        |               |            | 20032     | SOIC-8<br>(Pb-Free)   | 2500 / Tape and Reel |
| NCV20032DTBR2G*                      |               |            | K32       | TSSOP-8<br>(Pb-Free)  | 3000 / Tape and Reel |
| NCS20034DR2G                         | Quad          | No         | NCS20034G | SOIC-14<br>(Pb-Free)  | 2500 / Tape and Reel |
| NCV20034DR2G*                        |               | Yes        | NCS20034G | SOIC-14<br>(Pb-Free)  | 2500 / Tape and Reel |

†For information on tape and reel specifications, including part orientation and tape sizes, please refer to our Tape and Reel Packaging Specifications Brochure, BRD8011/D

\*NCV Prefix for Automotive and Other Applications Requiring Unique Site and Control Change Requirements; AEC-Q100 Qualified and PPAP Capable.

\*\*Contact local sales office for more information.

# NCS2003/A, NCV2003, NCS20032, NCV20032, NCS20034, NCV20034

## ABSOLUTE MAXIMUM RATINGS

Over operating free-air temperature, unless otherwise stated

| Parameter                            | Symbol | Limit | Unit |
|--------------------------------------|--------|-------|------|
| Supply Voltage ( $V_{DD} - V_{SS}$ ) | $V_S$  | 7.0   | V    |

## INPUT AND OUTPUT PINS

|                               |          |                       |    |
|-------------------------------|----------|-----------------------|----|
| Input Voltage (Note 1)        | $V_{IN}$ | $V_{SS} - 0.3$ to 7.0 | V  |
| Input Current                 | $I_{IN}$ | 10                    | mA |
| Output Short Current (Note 2) | $I_O$    | 100                   | mA |

## TEMPERATURE

|                      |           |            |    |
|----------------------|-----------|------------|----|
| Storage Temperature  | $T_{STG}$ | -65 to 150 | °C |
| Junction Temperature | $T_J$     | 150        | °C |

## ESD RATINGS (Note 3)

|                      |                                    |     |                      |   |
|----------------------|------------------------------------|-----|----------------------|---|
| Human Body Model     | NCx2003, A<br>NCx20032<br>NCx20034 | HBM | 3000<br>2000<br>3000 | V |
| Machine Model        | NCx2003, A<br>NCx20032<br>NCx20034 | MM  | 200<br>100<br>150    | V |
| Charged Device Model | NCx2003, A<br>NCx2003x             | CDM | 1000<br>2000         | V |

## OTHER PARAMETERS

|                                     |          |         |    |
|-------------------------------------|----------|---------|----|
| Moisture Sensitivity Level (Note 5) | MSL      | Level 1 |    |
| Latch-up Current (Note 4)           | $I_{LU}$ | 100     | mA |

Stresses exceeding those listed in the Maximum Ratings table may damage the device. If any of these limits are exceeded, device functionality should not be assumed, damage may occur and reliability may be affected.

- Neither input should exceed the range of  $V_{SS} - 300$  mV to 7.0 V. This device contains internal protection diodes between the input pins and  $V_{DD}$ . When  $V_{IN}$  exceeds  $V_{DD}$ , the input current should be limited to the specified value.
- Indefinite duration; however, maximum package power dissipation limits must be observed to ensure that the maximum junction temperature is not exceeded.
- This device series incorporates ESD protection and is tested by the following methods:  
ESD Human Body Model tested per AEC-Q100-002 and JESD22-A114  
ESD Machine Model tested per AEC-Q100-003 and JESD22-A115  
ESD Charged Device Model tested per AEC-Q100-011 and ANSI/ESD S5.3.1-2009
- Latch-up current tested per JEDEC Standard JESD78.
- Moisture Sensitivity Level tested per IPC/JEDEC standard J-STD-020A.

## THERMAL INFORMATION

| Thermal Metric                         | Symbol        | Package        | Single Layer Board (Note 6) | Multi Layer Board (Note 7) | Unit |
|--|---------------|----------------|-----------------------------|----------------------------|------|
| Junction to Ambient Thermal Resistance | $\theta_{JA}$ | SOT23-5/TSOP-5 | 408                         | 355                        | °C/W |
|  |               | SOT553-5       | 428                         | 406                        |      |
|  |               | Micro8/MSOP8   | 235                         | 163                        |      |
|  |               | SOIC-8         | 240                         | 179                        |      |
|  |               | TSSOP-8        | 300                         | 238                        |      |
|  |               | SOIC-14        | 167                         | 123                        |      |

6. Values based on a 1S standard PCB according to JEDEC51-3 with 1.0 oz copper and a 300 mm<sup>2</sup> copper area

7. Values based on a 1S2P standard PCB according to JEDEC51-7 with 1.0 oz copper and a 100 mm<sup>2</sup> copper area

## RECOMMENDED OPERATING CONDITIONS

| Parameter                                      | Symbol   | Min        | Max          | Unit |
|--|--|------------|--------------|------|
| Operating Supply Voltage ( $V_{DD} - V_{SS}$ ) | $V_S$  | 1.7        | 5.5          | V    |
| Specified Operating Range                      | NCS2003, A<br>NCV2003, NCx20032, NCx20034<br>$T_A$ | -40<br>-40 | +85<br>+125  | °C   |
| Input Common Mode Range                        | $V_{CM}$   | $V_{SS}$   | $V_{DD}-0.6$ | V    |

Functional operation above the stresses listed in the Recommended Operating Ranges is not implied. Extended exposure to stresses beyond the Recommended Operating Ranges limits may affect device reliability.

# NCS2003/A, NCV2003, NCS20032, NCV20032, NCS20034, NCV20034

## ELECTRICAL CHARACTERISTICS: $V_S = +1.8\text{ V}$

At  $T_A = +25^\circ\text{C}$ ,  $R_L = 10\text{ k}\Omega$  connected to midsupply,  $V_{CM} = V_{OUT} = \text{midsupply}$ , unless otherwise noted. **Boldface** limits apply over the specified temperature range. Guaranteed by design and/or characterization.

| Parameter                    | Symbol                   | Conditions  | Min       | Typ        | Max | Unit                         |
|------------------------------|--------------------------|---|-----------|------------|-----|------------------------------|
| <b>INPUT CHARACTERISTICS</b> |                          |   |           |            |     |                              |
| Input Offset Voltage         | $V_{OS}$                 | NCS2003A  |           | 0.5        | 3.0 | mV                           |
|                              |                          | NCx2003, NCx20032, NCx20034                                 |           | 0.5        | 4.0 | mV                           |
| Offset Voltage Drift         | $\Delta V_{OS}/\Delta T$ |   |           | <b>2.0</b> |     | $\mu\text{V}/^\circ\text{C}$ |
|                              |                          | NCS2003A (Note 8)   |           |            | 6.0 | $\mu\text{V}/^\circ\text{C}$ |
| Input Bias Current           | $I_{IB}$                 |   |           | 1          |     | pA                           |
| Input Offset Current         | $I_{OS}$                 |   |           | 1          |     | pA                           |
| Channel Separation           | XTLK                     | DC, NCx20032, NCx20034                                      |           | 100        |     | dB                           |
| Input Resistance             | $R_{IN}$                 |   |           | 1          |     | $\text{T}\Omega$             |
| Input Capacitance            | $C_{IN}$                 |   |           | 1.2        |     | pF                           |
| Common Mode Rejection Ratio  | CMRR                     | $V_{IN} = V_{SS}$ to $V_{DD} - 0.6\text{ V}$                | 70        | 80         |     | dB                           |
|                              |                          | $V_{IN} = V_{SS} + 0.2\text{ V}$ to $V_{DD} - 0.6\text{ V}$ | <b>65</b> |            |     |                              |

## OUTPUT CHARACTERISTICS

|                                    |           |                           |            |             |       |            |    |
|------------------------------------|-----------|---------------------------|------------|-------------|-------|------------|----|
| Open Loop Voltage Gain             | $A_{VOL}$ | $R_L = 10\text{ k}\Omega$ |            | 80          | 92    | dB         |    |
|                                    |           |                           |            | <b>75</b>   |       |            |    |
|                                    |           | $R_L = 2\text{ k}\Omega$  |            |             | 92    |            |    |
|                                    |           |                           |            | <b>70</b>   |       |            |    |
| Output Current Capability (Note 8) | $I_{SC}$  | Sourcing                  |            | 5           | 8     | mA         |    |
|                                    |           | Sinking                   |            | 10          | 14    |            |    |
| Output Voltage High                | $V_{OH}$  | $R_L = 10\text{ k}\Omega$ |            | <b>1.75</b> | 1.798 | V          |    |
|                                    |           | $R_L = 2\text{ k}\Omega$  |            | <b>1.7</b>  | 1.78  |            |    |
| Output Voltage Low                 | VOL       | $R_L = 10\text{ k}\Omega$ | NCx2003, A |             | 7     | <b>50</b>  | mV |
|                                    |           |                           | NCx2003x   |             | 7     | <b>100</b> |    |
|                                    |           | $R_L = 2\text{ k}\Omega$  |            |             |       | 20         |    |

## NOISE PERFORMANCE

|                       |       |                    |  |     |  |                              |
|-----------------------|-------|--------------------|--|-----|--|------------------------------|
| Voltage Noise Density | $e_N$ | $f = 1\text{ kHz}$ |  | 20  |  | $\text{nV}/\sqrt{\text{Hz}}$ |
| Current Noise Density | $i_N$ | $f = 1\text{ kHz}$ |  | 0.1 |  | $\text{pA}/\sqrt{\text{Hz}}$ |

## DYNAMIC PERFORMANCE

|                         |          |   |                          |   |     |                        |
|-------------------------|----------|---|--------------------------|---|-----|------------------------|
| Gain Bandwidth Product  | GBWP     |   |                          | 5 |     | MHz                    |
| Slew Rate at Unity Gain | SR       | Rising Edge, $R_L = 2\text{ k}\Omega$ , $A_V = +1$          |                          |   | 6   | $\text{V}/\mu\text{s}$ |
|                         |          | Falling Edge, $R_L = 2\text{ k}\Omega$ , $A_V = +1$         |                          |   | 9   |                        |
| Phase Margin            | $\psi_m$ | $R_L = 10\text{ k}\Omega$ , $C_L = 5\text{ pF}$             |                          |   | 53  | $^\circ$               |
| Gain Margin             | $A_m$    | $R_L = 10\text{ k}\Omega$ , $C_L = 5\text{ pF}$             | NCx2003, A               |   | 12  | dB                     |
|                         |          |   | NCx2003x                 |   | 8   |                        |
| Settling Time           | $t_s$    | $V_O = 1\text{ V}_{pp}$ ,<br>Gain = 1, $C_L = 20\text{ pF}$ | Settling time to<br>0.1% |   | 1.8 | $\mu\text{s}$          |

Product parametric performance is indicated in the Electrical Characteristics for the listed test conditions, unless otherwise noted. Product performance may not be indicated by the Electrical Characteristics if operated under different conditions.

8. Guaranteed by design and/or characterization.

# NCS2003/A, NCV2003, NCS20032, NCV20032, NCS20034, NCV20034

## ELECTRICAL CHARACTERISTICS: $V_S = +1.8\text{ V}$

At  $T_A = +25^\circ\text{C}$ ,  $R_L = 10\text{ k}\Omega$  connected to midsupply,  $V_{CM} = V_{OUT} = \text{midsupply}$ , unless otherwise noted. **Boldface** limits apply over the specified temperature range. Guaranteed by design and/or characterization.

| Parameter                          | Symbol | Conditions  | Min | Typ   | Max | Unit |
|------------------------------------|--------|---|-----|-------|-----|------|
| <b>DYNAMIC PERFORMANCE</b>         |        |   |     |       |     |      |
| Total Harmonics Distortion + Noise | THD+N  | $V_O = 1\text{ V}_{pp}$ , $R_L = 2\text{ k}\Omega$ , $A_V = +1$ , $f = 1\text{ kHz}$  |     | 0.005 |     | %    |
|                                    |        | $V_O = 1\text{ V}_{pp}$ , $R_L = 2\text{ k}\Omega$ , $A_V = +1$ , $f = 10\text{ kHz}$ |     | 0.025 |     |      |

## POWER SUPPLY

|                              |          |                      |                    |           |     |             |               |
|------------------------------|----------|----------------------|--------------------|-----------|-----|-------------|---------------|
| Power Supply Rejection Ratio | PSRR     | NCx2003              |                    | 72        | 80  |             | dB            |
|                              |          |                      |                    | <b>65</b> |     |             |               |
|                              |          | NCx20032, NCx20034   |                    | <b>80</b> | 100 |             |               |
| Quiescent Current            | $I_{DD}$ | No load, per channel | NCx2003, A         |           | 230 | 560         | $\mu\text{A}$ |
|                              |          |                      |                    |           |     | <b>1000</b> |               |
|                              |          |                      | NCx20032, NCx20034 |           | 275 | 375         |               |
|                              |          |                      |                    |           |     | <b>575</b>  |               |

Product parametric performance is indicated in the Electrical Characteristics for the listed test conditions, unless otherwise noted. Product performance may not be indicated by the Electrical Characteristics if operated under different conditions.

8. Guaranteed by design and/or characterization.

## ELECTRICAL CHARACTERISTICS: $V_S = +5.0\text{ V}$

At  $T_A = +25^\circ\text{C}$ ,  $R_L = 10\text{ k}\Omega$  connected to midsupply,  $V_{CM} = V_{OUT} = \text{midsupply}$ , unless otherwise noted. **Boldface** limits apply over the specified temperature range. Guaranteed by design and/or characterization.

| Parameter                    | Symbol                   | Conditions             | Min | Typ        | Max        | Unit                         |
|------------------------------|--------------------------|------------------------|-----|------------|------------|------------------------------|
| <b>INPUT CHARACTERISTICS</b> |                          |                        |     |            |            |                              |
| Input Offset Voltage         | $V_{OS}$                 | NCS2003A               |     | 0.5        | 3.0        | mV                           |
|                              |                          | NCx2003                |     | 0.5        | 4.0        | mV                           |
|                              |                          | NCx20032, NCx20034     |     |            | <b>5.0</b> |                              |
| Offset Voltage Drift         | $\Delta V_{OS}/\Delta T$ |                        |     | <b>2.0</b> |            | $\mu\text{V}/^\circ\text{C}$ |
|                              |                          | NCS2003A (Note 9)      |     |            | 6.0        | $\mu\text{V}/^\circ\text{C}$ |
| Input Bias Current           | $I_{IB}$                 |                        |     | 1          |            | pA                           |
| Input Offset Current         | $I_{OS}$                 |                        |     | 1          |            | pA                           |
| Channel Separation           | XTLK                     | DC, NCx20032, NCx20034 |     | 100        |            | dB                           |
| Input Resistance             | $R_{IN}$                 |                        |     | 1          |            | $\text{T}\Omega$             |
| Input Capacitance            | $C_{IN}$                 |                        |     | 1.2        |            | pF                           |

Product parametric performance is indicated in the Electrical Characteristics for the listed test conditions, unless otherwise noted. Product performance may not be indicated by the Electrical Characteristics if operated under different conditions.

9. Guaranteed by design and/or characterization.

# NCS2003/A, NCV2003, NCS20032, NCV20032, NCS20034, NCV20034

## ELECTRICAL CHARACTERISTICS: $V_S = +5.0\text{ V}$

At  $T_A = +25^\circ\text{C}$ ,  $R_L = 10\text{ k}\Omega$  connected to midsupply,  $V_{CM} = V_{OUT} = \text{midsupply}$ , unless otherwise noted. **Boldface** limits apply over the specified temperature range. Guaranteed by design and/or characterization.

| Parameter | Symbol | Conditions | Min | Typ | Max | Unit |
|-----------|--------|------------|-----|-----|-----|------|
|-----------|--------|------------|-----|-----|-----|------|

### INPUT CHARACTERISTICS

|                             |      |                    |   |           |    |  |    |
|-----------------------------|------|--------------------|---|-----------|----|--|----|
| Common Mode Rejection Ratio | CMRR | NCx2003, A         | $V_{IN} = V_{SS}$ to $V_{DD} - 0.6\text{ V}$                | 65        | 90 |  | dB |
|                             |      |                    | $V_{IN} = V_{SS} + 0.2\text{ V}$ to $V_{DD} - 0.6\text{ V}$ | <b>63</b> |    |  |    |
|                             |      | NCx20032, NCx20034 | $V_{IN} = V_{SS}$ to $V_{DD} - 0.6\text{ V}$                | 70        | 90 |  |    |
|                             |      |                    | $V_{IN} = V_{SS} + 0.2\text{ V}$ to $V_{DD} - 0.6\text{ V}$ | <b>65</b> |    |  |    |

### OUTPUT CHARACTERISTICS

|                                    |           |                           |            |             |      |            |    |
|------------------------------------|-----------|---------------------------|------------|-------------|------|------------|----|
| Open Loop Voltage Gain             | $A_{VOL}$ | $R_L = 10\text{ k}\Omega$ |            | 86          | 92   |            | dB |
|                                    |           |                           |            | <b>78</b>   |      |            |    |
|                                    |           | $R_L = 2\text{ k}\Omega$  |            | 83          | 92   |            |    |
|                                    |           |                           |            | <b>78</b>   |      |            |    |
| Output Current Capability (Note 9) | $I_{SC}$  | Sourcing                  |            | 40          | 76   |            | mA |
|                                    |           | Sinking                   |            | 50          | 96   |            |    |
| Output Voltage High                | $V_{OH}$  | $R_L = 10\text{ k}\Omega$ |            | <b>4.95</b> | 4.99 |            | V  |
|                                    |           | $R_L = 2\text{ k}\Omega$  |            | <b>4.9</b>  | 4.97 |            |    |
| Output Voltage Low                 | $V_{OL}$  | $R_L = 10\text{ k}\Omega$ | NCx2003, A |             | 8    | <b>50</b>  | mV |
|                                    |           |                           | NCx2003x   |             | 8    | <b>100</b> |    |
|                                    |           | $R_L = 2\text{ k}\Omega$  |            |             | 24   | <b>100</b> |    |

### NOISE PERFORMANCE

|                       |       |                    |  |     |  |                              |
|-----------------------|-------|--------------------|--|-----|--|------------------------------|
| Voltage Noise Density | $e_N$ | $f = 1\text{ kHz}$ |  | 20  |  | $\text{nV}/\sqrt{\text{Hz}}$ |
| Current Noise Density | $i_N$ | $f = 1\text{ kHz}$ |  | 0.1 |  | $\text{pA}/\sqrt{\text{Hz}}$ |

### DYNAMIC PERFORMANCE

|                                    |          |   |                          |       |  |                        |
|------------------------------------|----------|---|--------------------------|-------|--|------------------------|
| Gain Bandwidth Product             | GBWP     |   |                          | 7     |  | MHz                    |
| Slew Rate at Unity Gain            | SR       | Rising Edge, $R_L = 2\text{ k}\Omega$ , $A_V = +1$                                    |                          | 8     |  | $\text{V}/\mu\text{s}$ |
|                                    |          | Falling Edge, $R_L = 2\text{ k}\Omega$ , $A_V = +1$                                   |                          | 12.5  |  |                        |
| Phase Margin                       | $\psi_m$ | $R_L = 10\text{ k}\Omega$ , $C_L = 5\text{ pF}$                                       | NCx2003, A               | 64    |  | $^\circ$               |
|                                    |          |   | NCx2003x                 | 56    |  |                        |
| Gain Margin                        | $A_m$    | $R_L = 10\text{ k}\Omega$ , $C_L = 5\text{ pF}$                                       |                          | 9     |  | dB                     |
| Settling Time                      | $t_S$    | $V_O = 1\text{ V}_{pp}$ ,<br>Gain = 1, $C_L = 20\text{ pF}$                           | Settling time to<br>0.1% | 0.6   |  | $\mu\text{s}$          |
| Total Harmonics Distortion + Noise | THD+N    | $V_O = 4\text{ V}_{pp}$ , $R_L = 2\text{ k}\Omega$ , $A_V = +1$ , $f = 1\text{ kHz}$  |                          | 0.002 |  | %                      |
|                                    |          | $V_O = 4\text{ V}_{pp}$ , $R_L = 2\text{ k}\Omega$ , $A_V = +1$ , $f = 10\text{ kHz}$ |                          | 0.01  |  |                        |

Product parametric performance is indicated in the Electrical Characteristics for the listed test conditions, unless otherwise noted. Product performance may not be indicated by the Electrical Characteristics if operated under different conditions.

9. Guaranteed by design and/or characterization.

# NCS2003/A, NCV2003, NCS20032, NCV20032, NCS20034, NCV20034

## ELECTRICAL CHARACTERISTICS: $V_S = +5.0\text{ V}$

At  $T_A = +25^\circ\text{C}$ ,  $R_L = 10\text{ k}\Omega$  connected to midsupply,  $V_{CM} = V_{OUT} = \text{midsupply}$ , unless otherwise noted. **Boldface** limits apply over the specified temperature range. Guaranteed by design and/or characterization.

| Parameter                    | Symbol   | Conditions           | Min                | Typ       | Max | Unit |             |               |
|------------------------------|----------|----------------------|--------------------|-----------|-----|------|-------------|---------------|
| <b>POWER SUPPLY</b>          |          |                      |                    |           |     |      |             |               |
| Power Supply Rejection Ratio | PSRR     | NCx2003, A           |                    | 72        | 80  |      | dB          |               |
|                              |          |                      |                    | <b>65</b> |     |      |             |               |
|                              |          | NCx20032, NCx20034   |                    | <b>80</b> | 100 |      |             |               |
| Quiescent Current            | $I_{DD}$ | No load, per channel | NCx2003, A         |           |     | 300  | 660         | $\mu\text{A}$ |
|                              |          |                      |                    |           |     |      | <b>1000</b> |               |
|                              |          |                      | NCx20032, NCx20034 |           |     | 325  | 450         |               |
|                              |          |                      |                    |           |     |      | <b>675</b>  |               |

Product parametric performance is indicated in the Electrical Characteristics for the listed test conditions, unless otherwise noted. Product performance may not be indicated by the Electrical Characteristics if operated under different conditions.

9. Guaranteed by design and/or characterization.

TYPICAL CHARACTERISTICS

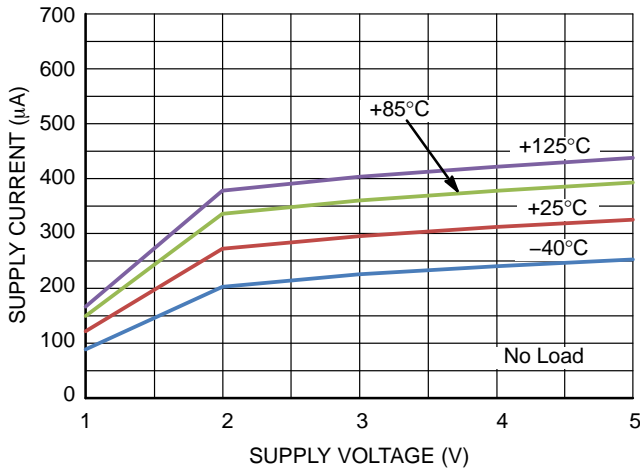

Figure 2. Quiescent Supply Current vs. Supply Voltage

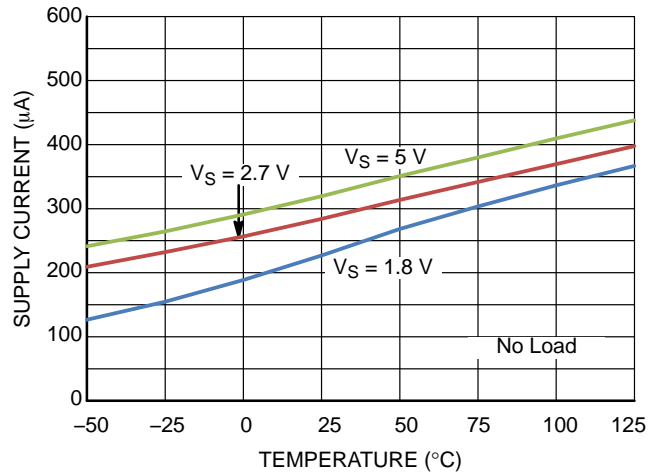

Figure 3. Quiescent Supply Current vs. Temperature

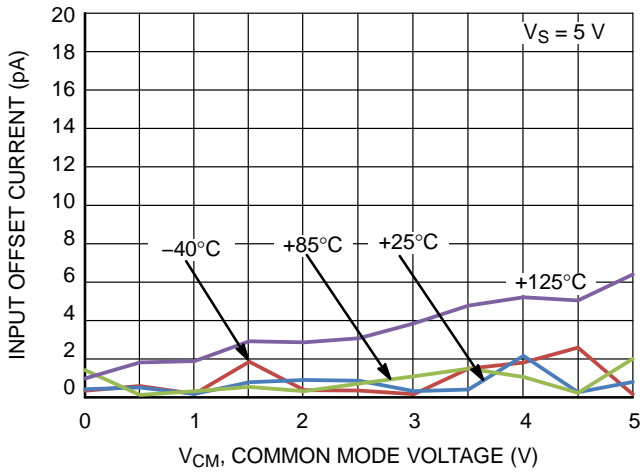

Figure 4. Input Offset Current vs.  $V_{CM}$

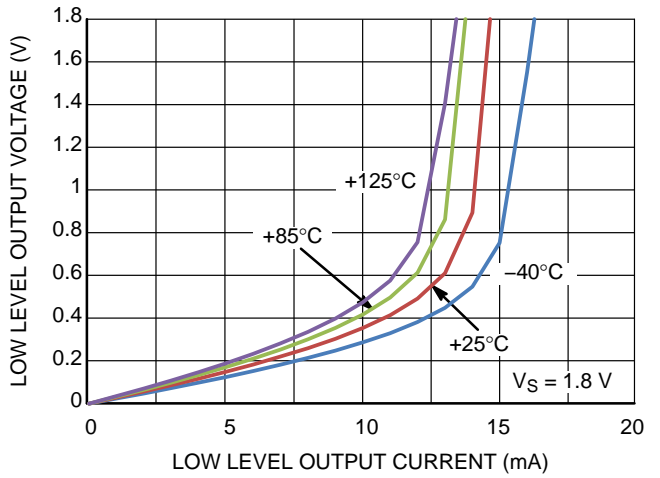

Figure 5. Low Level Output Voltage vs. Output Current @  $V_S = 1.8 V$

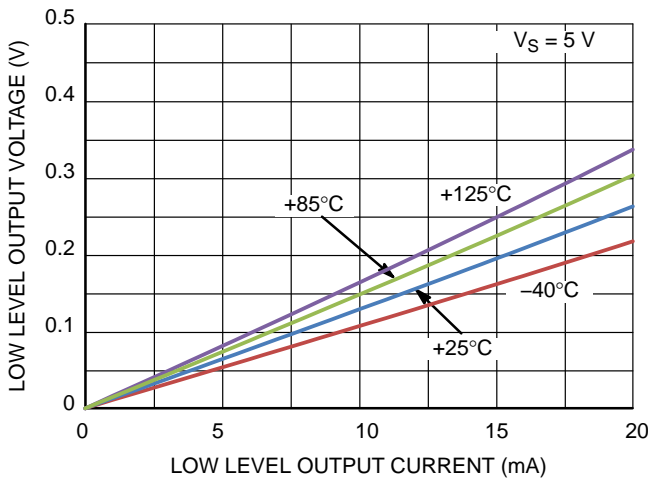

Figure 6. Low Level Output Voltage vs. Output Current @  $V_S = 5 V$

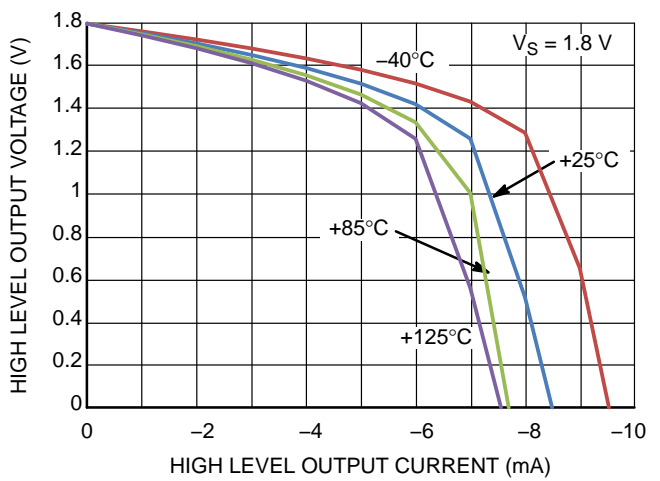

Figure 7. High Level Output Voltage vs. Output Current @  $V_S = 1.8 V$



TYPICAL CHARACTERISTICS



Figure 8. High Level Output Voltage vs. Output Current @  $V_S = 5\text{ V}$

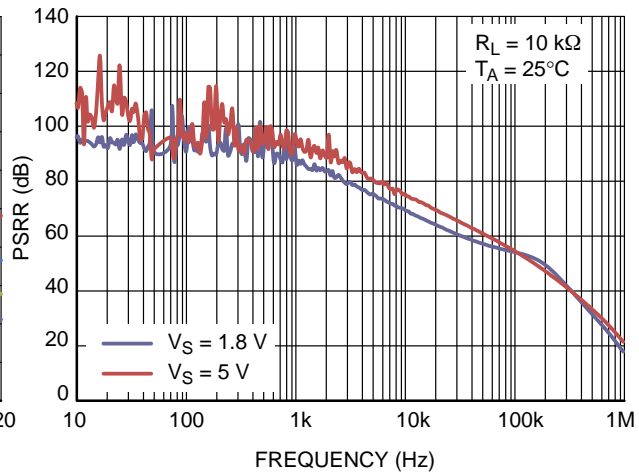

Figure 9. PSRR vs. Frequency



Figure 10. CMRR vs. Frequency



Figure 11. Open Loop Gain and Phase vs. Frequency @  $V_S = 1.8\text{ V}$

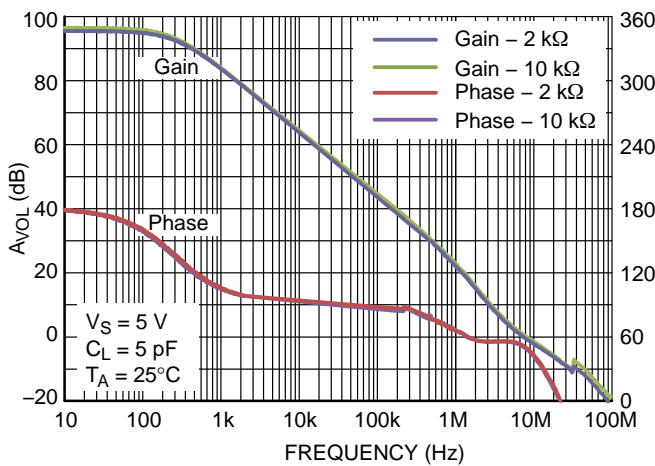

Figure 12. Open Loop Gain and Phase vs. Frequency @  $V_S = 5\text{ V}$

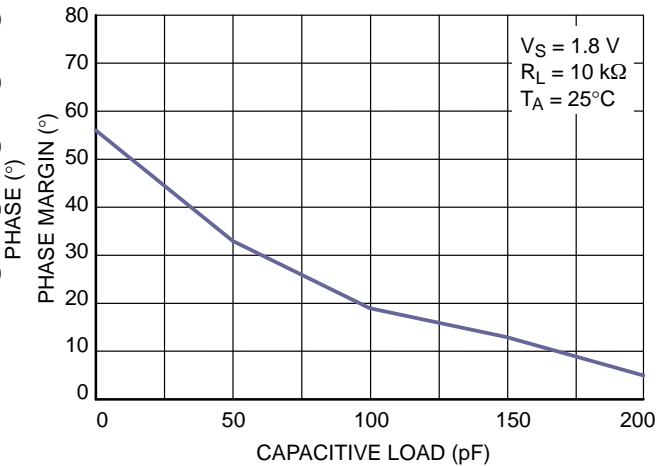

Figure 13. Phase Margin vs. Capacitive Load

TYPICAL CHARACTERISTICS



Figure 14. Inverting Small Signal Transient Response



Figure 15. Non-Inverting Small Signal Transient Response



Figure 16. Inverting Large Signal Transient Response



Figure 17. Non-Inverting Large Signal Transient Response



Figure 18. Non-Inverting Large Signal Transient Response

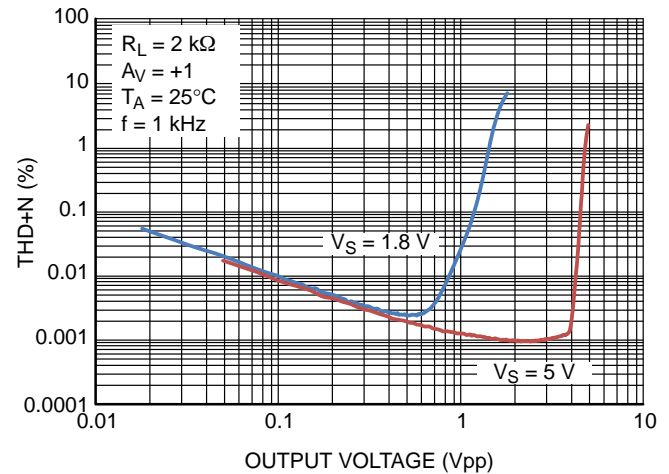

Figure 19. THD+N vs. Output Voltage

TYPICAL CHARACTERISTICS

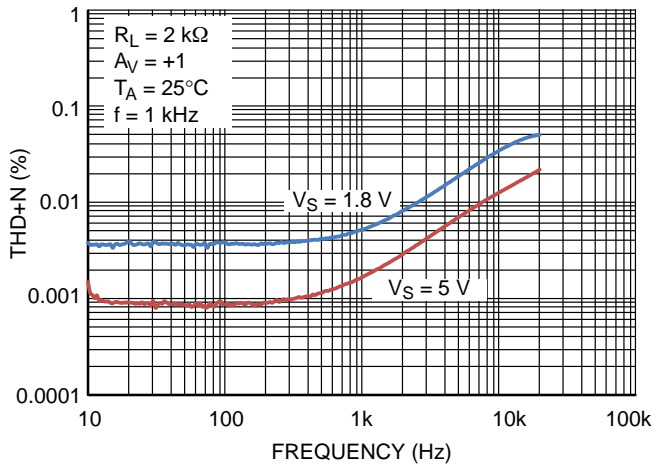

Figure 20. THD+N vs. Frequency

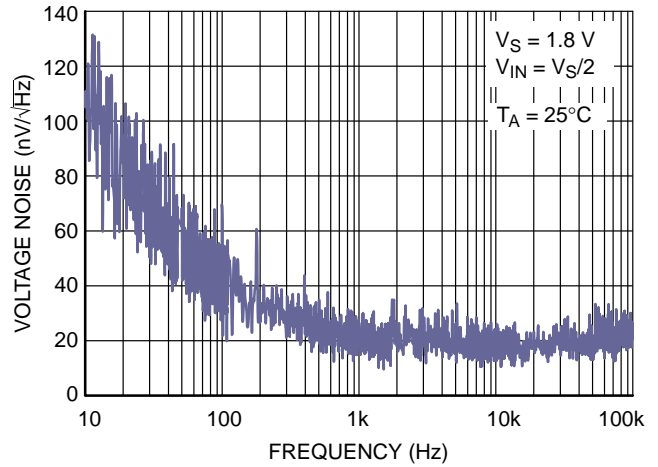

Figure 21. Input Voltage Noise vs. Frequency

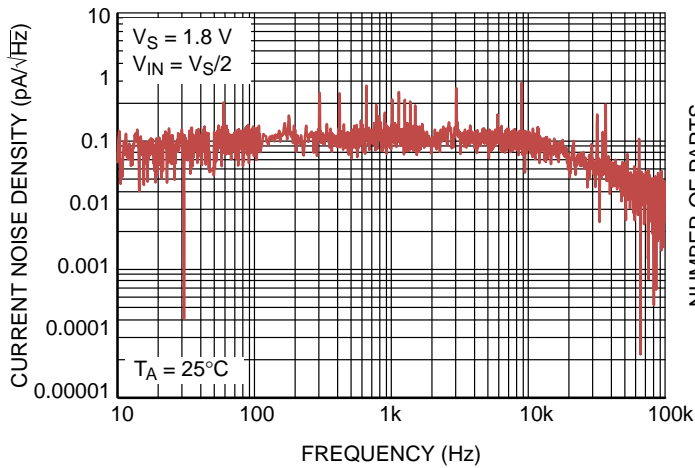

Figure 22. Noise Density vs. Frequency

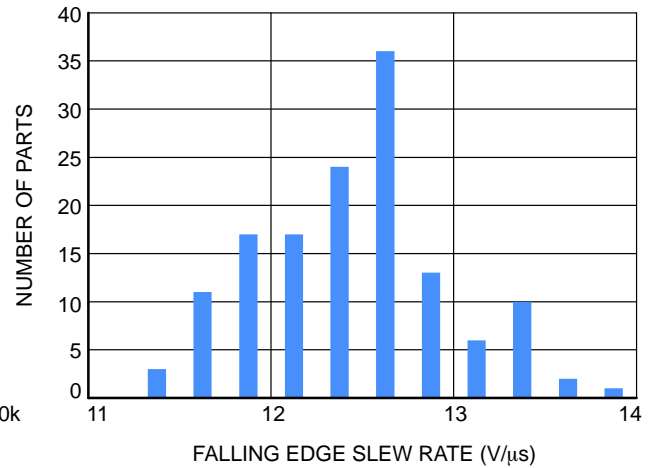

Figure 23. Falling Edge Slew Rate @ Vs = 5 V

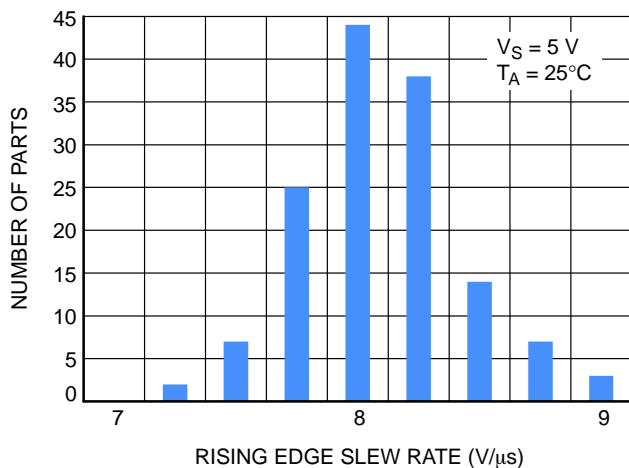

Figure 24. Rising Edge Slew Rate @ Vs = 5 V

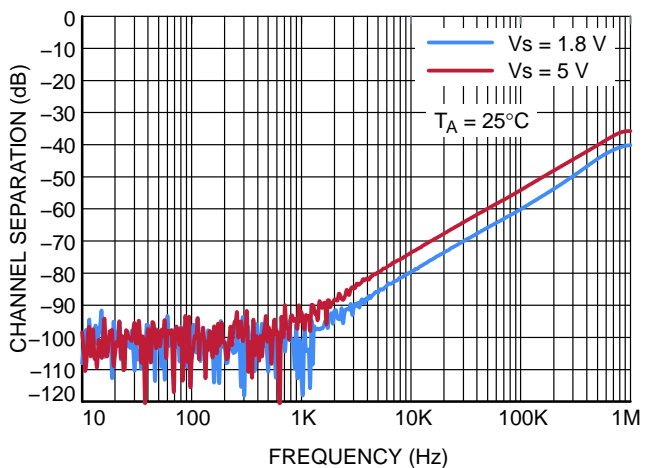
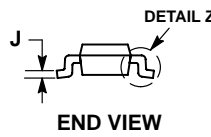
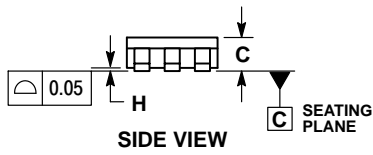
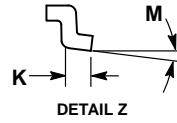
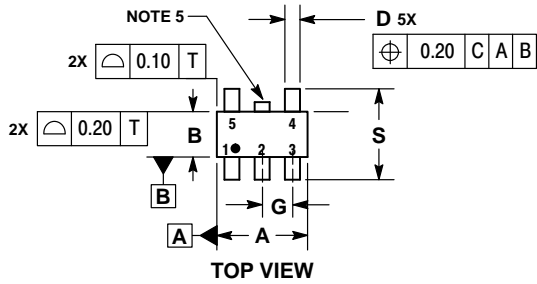

Figure 25. Channel Separation

PACKAGE DIMENSIONS

TSOP-5  
CASE 483-02  
ISSUE K



NOTES:

1. DIMENSIONING AND TOLERANCING PER ASME Y14.5M, 1994.
2. CONTROLLING DIMENSION: MILLIMETERS.
3. MAXIMUM LEAD THICKNESS INCLUDES LEAD FINISH THICKNESS. MINIMUM LEAD THICKNESS IS THE MINIMUM THICKNESS OF BASE MATERIAL.
4. DIMENSIONS A AND B DO NOT INCLUDE MOLD FLASH, PROTRUSIONS, OR GATE BURRS. MOLD FLASH, PROTRUSIONS, OR GATE BURRS SHALL NOT EXCEED 0.15 PER SIDE. DIMENSION A.
5. OPTIONAL CONSTRUCTION: AN ADDITIONAL TRIMMED LEAD IS ALLOWED IN THIS LOCATION. TRIMMED LEAD NOT TO EXTEND MORE THAN 0.2 FROM BODY.

| DIM | MILLIMETERS |      |
|-----|-------------|------|
|     | MIN         | MAX  |
| A   | 3.00 BSC    |      |
| B   | 1.50 BSC    |      |
| C   | 0.90        | 1.10 |
| D   | 0.25        | 0.50 |
| G   | 0.95 BSC    |      |
| H   | 0.01        | 0.10 |
| J   | 0.10        | 0.26 |
| K   | 0.20        | 0.60 |
| M   | 0° 10°      |      |
| S   | 2.50        | 3.00 |

SOLDERING FOOTPRINT\*

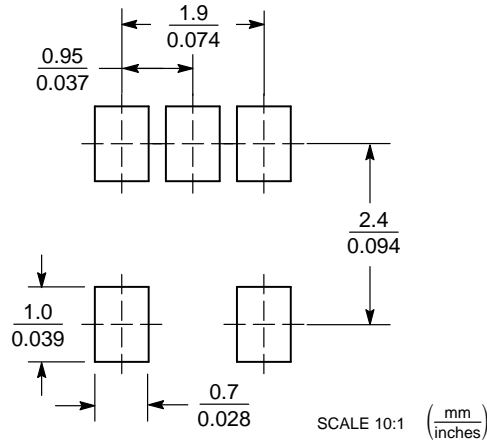

\*For additional information on our Pb-Free strategy and soldering details, please download the ON Semiconductor Soldering and Mounting Techniques Reference Manual, SOLDERRM/D.

PACKAGE DIMENSIONS

SOT-553, 5 LEAD  
CASE 463B  
ISSUE C

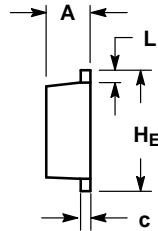
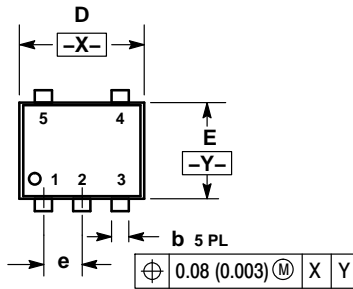

NOTES:

1. DIMENSIONING AND TOLERANCING PER ANSI Y14.5M, 1982.
2. CONTROLLING DIMENSION: MILLIMETERS
3. MAXIMUM LEAD THICKNESS INCLUDES LEAD FINISH THICKNESS. MINIMUM LEAD THICKNESS IS THE MINIMUM THICKNESS OF BASE MATERIAL.

| DIM | MILLIMETERS |      |      | INCHES    |       |       |
|-----|-------------|------|------|-----------|-------|-------|
|     | MIN         | NOM  | MAX  | MIN       | NOM   | MAX   |
| A   | 0.50        | 0.55 | 0.60 | 0.020     | 0.022 | 0.024 |
| b   | 0.17        | 0.22 | 0.27 | 0.007     | 0.009 | 0.011 |
| c   | 0.08        | 0.13 | 0.18 | 0.003     | 0.005 | 0.007 |
| D   | 1.55        | 1.60 | 1.65 | 0.061     | 0.063 | 0.065 |
| E   | 1.15        | 1.20 | 1.25 | 0.045     | 0.047 | 0.049 |
| e   | 0.50 BSC    |      |      | 0.020 BSC |       |       |
| L   | 0.10        | 0.20 | 0.30 | 0.004     | 0.008 | 0.012 |
| HE  | 1.55        | 1.60 | 1.65 | 0.061     | 0.063 | 0.065 |

RECOMMENDED  
SOLDERING FOOTPRINT\*

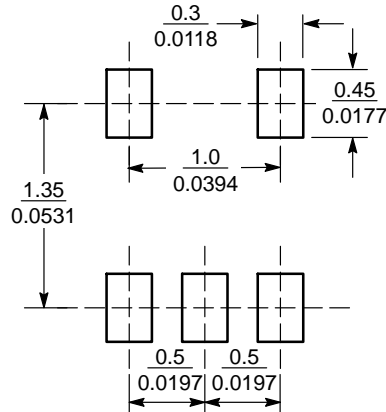

SCALE 20:1 (mm/inches)

\*For additional information on our Pb-Free strategy and soldering details, please download the ON Semiconductor Soldering and Mounting Techniques Reference Manual, SOLDERRM/D.

PACKAGE DIMENSIONS

Micro8™  
CASE 846A-02  
ISSUE J

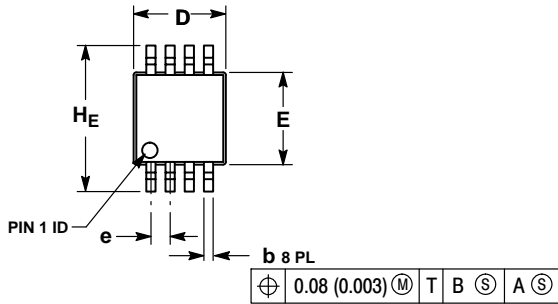

NOTES:

1. DIMENSIONING AND TOLERANCING PER ANSI Y14.5M, 1982.
2. CONTROLLING DIMENSION: MILLIMETER.
3. DIMENSION A DOES NOT INCLUDE MOLD FLASH, PROTRUSIONS OR GATE BURRS. MOLD FLASH, PROTRUSIONS OR GATE BURRS SHALL NOT EXCEED 0.15 (0.006) PER SIDE.
4. DIMENSION B DOES NOT INCLUDE INTERLEAD FLASH OR PROTRUSION. INTERLEAD FLASH OR PROTRUSION SHALL NOT EXCEED 0.25 (0.010) PER SIDE.
5. 846A-01 OBSOLETE, NEW STANDARD 846A-02.

| DIM | MILLIMETERS |      |      | INCHES    |       |       |
|-----|-------------|------|------|-----------|-------|-------|
|     | MIN         | NOM  | MAX  | MIN       | NOM   | MAX   |
| A   | —           | —    | 1.10 | —         | —     | 0.043 |
| A1  | 0.05        | 0.08 | 0.15 | 0.002     | 0.003 | 0.006 |
| b   | 0.25        | 0.33 | 0.40 | 0.010     | 0.013 | 0.016 |
| c   | 0.13        | 0.18 | 0.23 | 0.005     | 0.007 | 0.009 |
| D   | 2.90        | 3.00 | 3.10 | 0.114     | 0.118 | 0.122 |
| E   | 2.90        | 3.00 | 3.10 | 0.114     | 0.118 | 0.122 |
| e   | 0.65 BSC    |      |      | 0.026 BSC |       |       |
| L   | 0.40        | 0.55 | 0.70 | 0.016     | 0.021 | 0.028 |
| HE  | 4.75        | 4.90 | 5.05 | 0.187     | 0.193 | 0.199 |

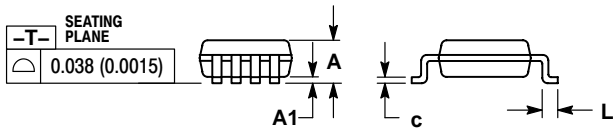

RECOMMENDED  
SOLDERING FOOTPRINT\*

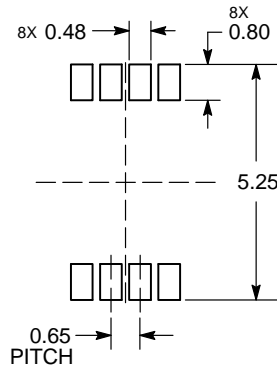

DIMENSION: MILLIMETERS

\*For additional information on our Pb-Free strategy and soldering details, please download the ON Semiconductor Soldering and Mounting Techniques Reference Manual, SOLDERRM/D.

PACKAGE DIMENSIONS

SOIC-8 NB  
CASE 751-07  
ISSUE AK

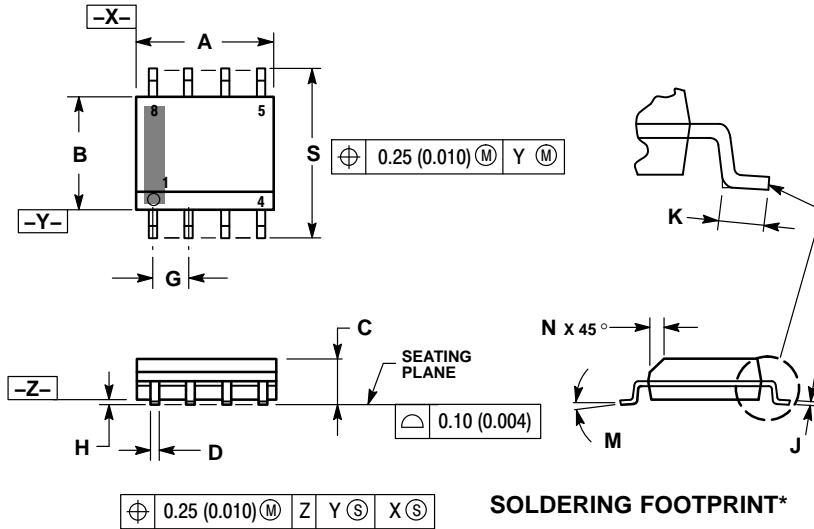

NOTES:

1. DIMENSIONING AND TOLERANCING PER ANSI Y14.5M, 1982.
2. CONTROLLING DIMENSION: MILLIMETER.
3. DIMENSION A AND B DO NOT INCLUDE MOLD PROTRUSION.
4. MAXIMUM MOLD PROTRUSION 0.15 (0.006) PER SIDE.
5. DIMENSION D DOES NOT INCLUDE DAMBAR PROTRUSION. ALLOWABLE DAMBAR PROTRUSION SHALL BE 0.127 (0.005) TOTAL IN EXCESS OF THE D DIMENSION AT MAXIMUM MATERIAL CONDITION.
6. 751-01 THRU 751-06 ARE OBSOLETE. NEW STANDARD IS 751-07.

| DIM | MILLIMETERS |      | INCHES    |       |
|-----|-------------|------|-----------|-------|
|     | MIN         | MAX  | MIN       | MAX   |
| A   | 4.80        | 5.00 | 0.189     | 0.197 |
| B   | 3.80        | 4.00 | 0.150     | 0.157 |
| C   | 1.35        | 1.75 | 0.053     | 0.069 |
| D   | 0.33        | 0.51 | 0.013     | 0.020 |
| G   | 1.27 BSC    |      | 0.050 BSC |       |
| H   | 0.10        | 0.25 | 0.004     | 0.010 |
| J   | 0.19        | 0.25 | 0.007     | 0.010 |
| K   | 0.40        | 1.27 | 0.016     | 0.050 |
| M   | 0° - 8°     |      | 0° - 8°   |       |
| N   | 0.25        | 0.50 | 0.010     | 0.020 |
| S   | 5.80        | 6.20 | 0.228     | 0.244 |

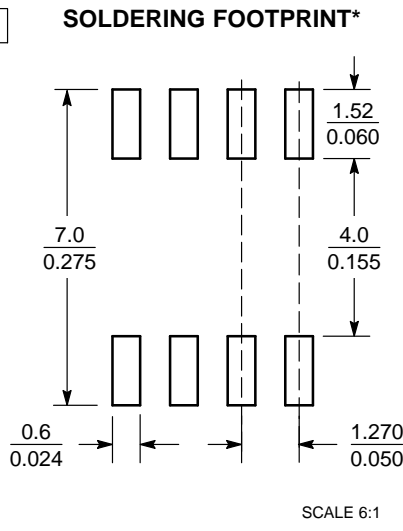

\*For additional information on our Pb-Free strategy and soldering details, please download the ON Semiconductor Soldering and Mounting Techniques Reference Manual, SOLDERRM/D.

PACKAGE DIMENSIONS

TSSOP-8  
CASE 948S  
ISSUE C

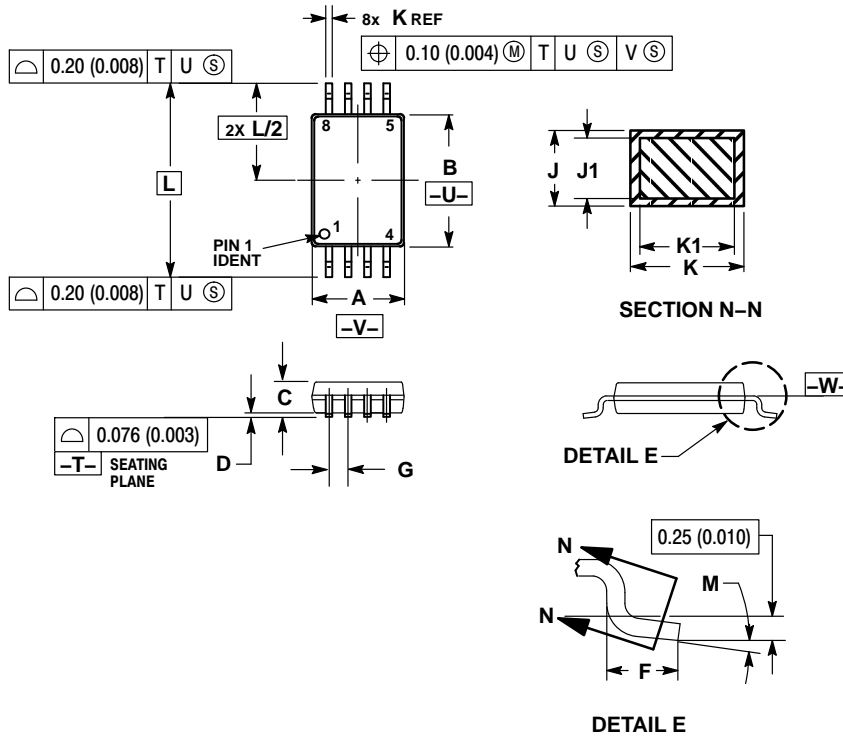

- NOTES:
1. DIMENSIONING AND TOLERANCING PER ANSI Y14.5M, 1982.
  2. CONTROLLING DIMENSION: MILLIMETER.
  3. DIMENSION A DOES NOT INCLUDE MOLD FLASH. PROTRUSIONS OR GATE BURRS. MOLD FLASH OR GATE BURRS SHALL NOT EXCEED 0.15 (0.006) PER SIDE.
  4. DIMENSION B DOES NOT INCLUDE INTERLEAD FLASH OR PROTRUSION. INTERLEAD FLASH OR PROTRUSION SHALL NOT EXCEED 0.25 (0.010) PER SIDE.
  5. TERMINAL NUMBERS ARE SHOWN FOR REFERENCE ONLY.
  6. DIMENSION A AND B ARE TO BE DETERMINED AT DATUM PLANE -W-.

| DIM | MILLIMETERS |      | INCHES    |       |
|-----|-------------|------|-----------|-------|
|     | MIN         | MAX  | MIN       | MAX   |
| A   | 2.90        | 3.10 | 0.114     | 0.122 |
| B   | 4.30        | 4.50 | 0.169     | 0.177 |
| C   | ---         | 1.10 | ---       | 0.043 |
| D   | 0.05        | 0.15 | 0.002     | 0.006 |
| F   | 0.50        | 0.70 | 0.020     | 0.028 |
| G   | 0.65 BSC    |      | 0.026 BSC |       |
| J   | 0.09        | 0.20 | 0.004     | 0.008 |
| J1  | 0.09        | 0.16 | 0.004     | 0.006 |
| K   | 0.19        | 0.30 | 0.007     | 0.012 |
| K1  | 0.19        | 0.25 | 0.007     | 0.010 |
| L   | 6.40 BSC    |      | 0.252 BSC |       |
| M   | 0°          | 8°   | 0°        | 8°    |



PACKAGE DIMENSIONS

SOIC-14 NB  
CASE 751A-03  
ISSUE K

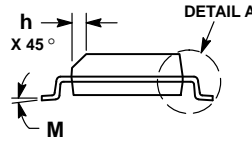
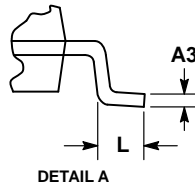
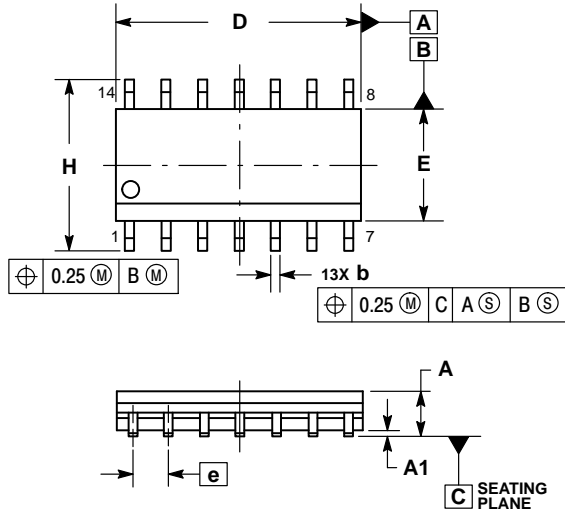

NOTES:

1. DIMENSIONING AND TOLERANCING PER ASME Y14.5M, 1994.
2. CONTROLLING DIMENSION: MILLIMETERS.
3. DIMENSION b DOES NOT INCLUDE DAMBAR PROTRUSION. ALLOWABLE PROTRUSION SHALL BE 0.13 TOTAL IN EXCESS OF AT MAXIMUM MATERIAL CONDITION.
4. DIMENSIONS D AND E DO NOT INCLUDE MOLD PROTRUSIONS.
5. MAXIMUM MOLD PROTRUSION 0.15 PER SIDE.

| DIM | MILLIMETERS |      | INCHES    |       |
|-----|-------------|------|-----------|-------|
|     | MIN         | MAX  | MIN       | MAX   |
| A   | 1.35        | 1.75 | 0.054     | 0.068 |
| A1  | 0.10        | 0.25 | 0.004     | 0.010 |
| A3  | 0.19        | 0.25 | 0.008     | 0.010 |
| b   | 0.35        | 0.49 | 0.014     | 0.019 |
| D   | 8.55        | 8.75 | 0.337     | 0.344 |
| E   | 3.80        | 4.00 | 0.150     | 0.157 |
| e   | 1.27 BSC    |      | 0.050 BSC |       |
| H   | 5.80        | 6.20 | 0.228     | 0.244 |
| h   | 0.25        | 0.50 | 0.010     | 0.019 |
| L   | 0.40        | 1.25 | 0.016     | 0.049 |
| M   | 0°          | 7°   | 0°        | 7°    |

SOLDERING FOOTPRINT\*

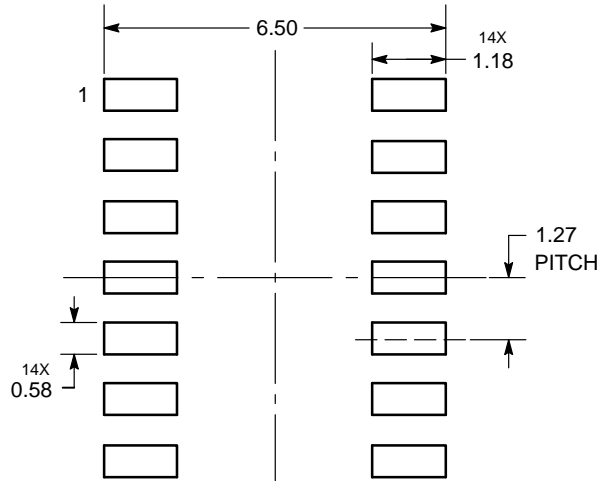

DIMENSIONS: MILLIMETERS

\*For additional information on our Pb-Free strategy and soldering details, please download the ON Semiconductor Soldering and Mounting Techniques Reference Manual, SOLDERRM/D.

Micro8 is a trademark of International Rectifier.

ON Semiconductor and the are registered trademarks of Semiconductor Components Industries, LLC (SCILLC) or its subsidiaries in the United States and/or other countries. SCILLC owns the rights to a number of patents, trademarks, copyrights, trade secrets, and other intellectual property. A listing of SCILLC's product/patent coverage may be accessed at [www.onsemi.com/site/pdf/Patent-Marking.pdf](http://www.onsemi.com/site/pdf/Patent-Marking.pdf). SCILLC reserves the right to make changes without further notice to any products herein. SCILLC makes no warranty, representation or guarantee regarding the suitability of its products for any particular purpose, nor does SCILLC assume any liability arising out of the application or use of any product or circuit, and specifically disclaims any and all liability, including without limitation special, consequential or incidental damages. "Typical" parameters which may be provided in SCILLC data sheets and/or specifications can and do vary in different applications and actual performance may vary over time. All operating parameters, including "Typicals" must be validated for each customer application by customer's technical experts. SCILLC does not convey any license under its patent rights nor the rights of others. SCILLC products are not designed, intended, or authorized for use as components in systems intended for surgical implant into the body, or other applications intended to support or sustain life, or for any other application in which the failure of the SCILLC product could create a situation where personal injury or death may occur. Should Buyer purchase or use SCILLC products for any such unintended or unauthorized application, Buyer shall indemnify and hold SCILLC and its officers, employees, subsidiaries, affiliates, and distributors harmless against all claims, costs, damages, and expenses, and reasonable attorney fees arising out of, directly or indirectly, any claim of personal injury or death associated with such unintended or unauthorized use, even if such claim alleges that SCILLC was negligent regarding the design or manufacture of the part. SCILLC is an Equal Opportunity/Affirmative Action Employer. This literature is subject to all applicable copyright laws and is not for resale in any manner.

PUBLICATION ORDERING INFORMATION

**LITERATURE FULFILLMENT:**  
Literature Distribution Center for ON Semiconductor  
P.O. Box 5163, Denver, Colorado 80217 USA  
**Phone:** 303-675-2175 or 800-344-3860 Toll Free USA/Canada  
**Fax:** 303-675-2176 or 800-344-3867 Toll Free USA/Canada  
**Email:** [orderlit@onsemi.com](mailto:orderlit@onsemi.com)

**N. American Technical Support:** 800-282-9855 Toll Free USA/Canada  
**Europe, Middle East and Africa Technical Support:**  
Phone: 421 33 790 2910  
**Japan Customer Focus Center**  
Phone: 81-3-5817-1050

**ON Semiconductor Website:** [www.onsemi.com](http://www.onsemi.com)  
**Order Literature:** <http://www.onsemi.com/orderlit>  
For additional information, please contact your local Sales Representative



Компания «ЭлектроПласт» предлагает заключение долгосрочных отношений при поставках импортных электронных компонентов на взаимовыгодных условиях!

Наши преимущества:

- Оперативные поставки широкого спектра электронных компонентов отечественного и импортного производства напрямую от производителей и с крупнейших мировых складов;
- Поставка более 17-ти миллионов наименований электронных компонентов;
- Поставка сложных, дефицитных, либо снятых с производства позиций;
- Оперативные сроки поставки под заказ (от 5 рабочих дней);
- Экспресс доставка в любую точку России;
- Техническая поддержка проекта, помощь в подборе аналогов, поставка прототипов;
- Система менеджмента качества сертифицирована по Международному стандарту ISO 9001;
- Лицензия ФСБ на осуществление работ с использованием сведений, составляющих государственную тайну;
- Поставка специализированных компонентов (Xilinx, Altera, Analog Devices, Intersil, Interpoint, Microsemi, Aeroflex, Peregrine, Syfer, Eurofarad, Texas Instrument, Miteq, Cobham, E2V, MA-COM, Hittite, Mini-Circuits, General Dynamics и др.);

Помимо этого, одним из направлений компании «ЭлектроПласт» является направление «Источники питания». Мы предлагаем Вам помощь Конструкторского отдела:

- Подбор оптимального решения, техническое обоснование при выборе компонента;
- Подбор аналогов;
- Консультации по применению компонента;
- Поставка образцов и прототипов;
- Техническая поддержка проекта;
- Защита от снятия компонента с производства.



#### Как с нами связаться

**Телефон:** 8 (812) 309 58 32 (многоканальный)

**Факс:** 8 (812) 320-02-42

**Электронная почта:** [org@eplast1.ru](mailto:org@eplast1.ru)

**Адрес:** 198099, г. Санкт-Петербург, ул. Калинина, дом 2, корпус 4, литера А.