

# IoT Optimized Ultra-Miniature Quartz Crystal



ABM13W SERIES



**1.20 x 1.00 x 0.33mm**  
**RoHS/RoHS II Complaint**  
**MSL = N/A: Not Applicable**

## FEATURES

- World's smallest At-Cut MHz Crystal (1.20 x 1.00 x 0.33 mm package)
- Ideally suited for space constraint IoT, Wearables & Wireless applications
- Simultaneously optimized for low plating load & ESR over extended temperature range
- Enhanced performance for start-up time and power savings with Low Energy SoC's
- Low profile ideal for height constraint designs
- Available with  $\pm 10$  ppm set-tolerance

## APPLICATIONS

- Wearables
- Wireless Modules
- Internet of Things (IoT)
- Bluetooth / Bluetooth Low Energy (BLE)
- Machine-to-Machine (M2M) Connectivity
- Ultra-Low Power MCU's, SoC's, Transceivers
- Near Field Communication
- ISM Band Applications

## Electrical Specifications

Parameters	Min.	Typ.	Max.	Units	Note
Frequency Range	32.0000		80.0000	MHz	
Standard Available Frequencies	32.0000, 37.4000, 38.4000, 40.0000, 45.0000, 48.0000, 52.0000, 60.0000, 76.8000, 80.0000			MHz	Contact Abracon for Nonstandard Frequencies
Operation Mode	Fundamental				
Operating Temperature Range	-40		+85	°C	See Options
Storage Temperature	-40		+125	°C	
Frequency Tolerance @ +25°C	-10		+10	ppm	See options
Frequency Stability over the Operating Temperature ( ref. to +25°C)	-15		+15	ppm	See options
Equivalent series resistance (R1) (over -40°C to +125°C)		< 45	100	$\Omega$	32.0000-32.9999MHz
		< 35	80		33.0000-36.9999MHz
		< 25	50		37.0000-80.0000MHz
Shunt capacitance (C0)			1.0	pF	
Load capacitance (CL)		5.0		pF	See options
Drive Level		10	100	$\mu$ W	
Aging (1 year)	-2		+2	ppm	@25°C $\pm$ 3°C
Insulation Resistance	500			M $\Omega$	@100 Vdc $\pm$ 15V



5101 Hidden Creek Ln Spicewood TX 78669  
 Phone: 512-371-6159 | Fax: 512-351-8858  
 For terms and conditions of sales, please visit:  
[www.abracon.com](http://www.abracon.com)

REVISED: 02.17.2020

ABRACON IS  
 ISO9001-2015  
 CERTIFIED

# IoT Optimized Ultra-Miniature Quartz Crystal



ABM13W SERIES



**1.20 x 1.00 x 0.33mm**  
**RoHS/RoHS II Complaint**  
**MSL = N/A: Not Applicable**

## Options and Part Identification [Note 1]



(\*) Only offered @ Operating Temp. Range options: B & N  
 (\*\*) Only offered @ Operating Temp. Range options: B, N, & D  
 (\*\*\*) Only offered @ Operating Temp. Range options: B, N, D, & J  
 Contact ABRACON for tighter Frequency Stability options.

**Note 1:**  
 Contact Abracon for part number requests with carrier frequency callouts up to 5 & 6 digit accuracy after the decimal.



5101 Hidden Creek Ln Spicewood TX 78669  
 Phone: 512-371-6159 | Fax: 512-351-8858  
 For terms and conditions of sales, please visit:  
[www.abracon.com](http://www.abracon.com)

REVISED: 02.17.2020

ABRACON IS  
 ISO9001-2015  
 CERTIFIED

# IoT Optimized Ultra-Miniature Quartz Crystal



ABM13W SERIES



1.20 x 1.00 x 0.33mm  
RoHS/RoHS II Complaint  
MSL = N/A: Not Applicable

## Typical Frequency vs. Temperature Characteristics (ref. to +25°C):



## Typical ESR (Equivalent Series Resistance) vs. Temperature Characteristics:

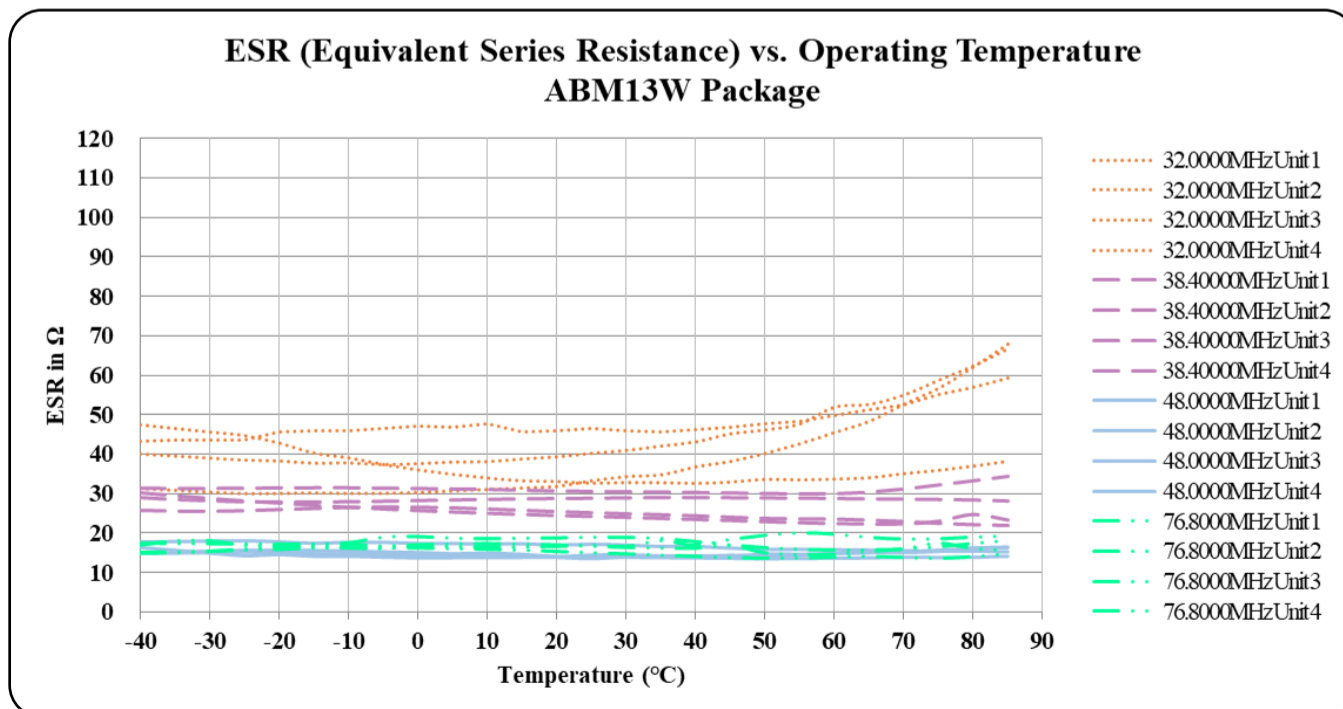

# IoT Optimized Ultra-Miniature Quartz Crystal

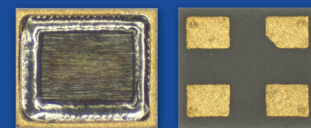

ABM13W SERIES



1.20 x 1.00 x 0.33mm  
 RoHS/RoHS II Complaint  
 MSL = N/A: Not Applicable

## SPICE Models (based on typical values at 25°C ± 3°C):



<b>Frequency: 32.0000MHz</b>				<b>Frequency: 38.4000MHz</b>			
<b>Plating Load: 8pF</b>				<b>Plating Load: 6pF</b>			
C0	=	0.46	pF	C0	=	0.48	pF
R1	=	41.19	Ω	R1	=	22.48	Ω
L1	=	16.91	mH	L1	=	10.99	mH
C1	=	1.46	fF	C1	=	1.57	fF
<b>Frequency: 48.0000MHz</b>				<b>Frequency: 76.8000MHz</b>			
<b>Plating Load: 6pF</b>				<b>Plating Load: 6pF</b>			
C0	=	0.86	pF	C0	=	0.77	pF
R1	=	19.50	Ω	R1	=	16.97	Ω
L1	=	5.73	mH	L1	=	1.58	mH
C1	=	1.92	fF	C1	=	2.74	fF

## Typical Frequency Tolerance Distribution (at 25°C ± 3°C):

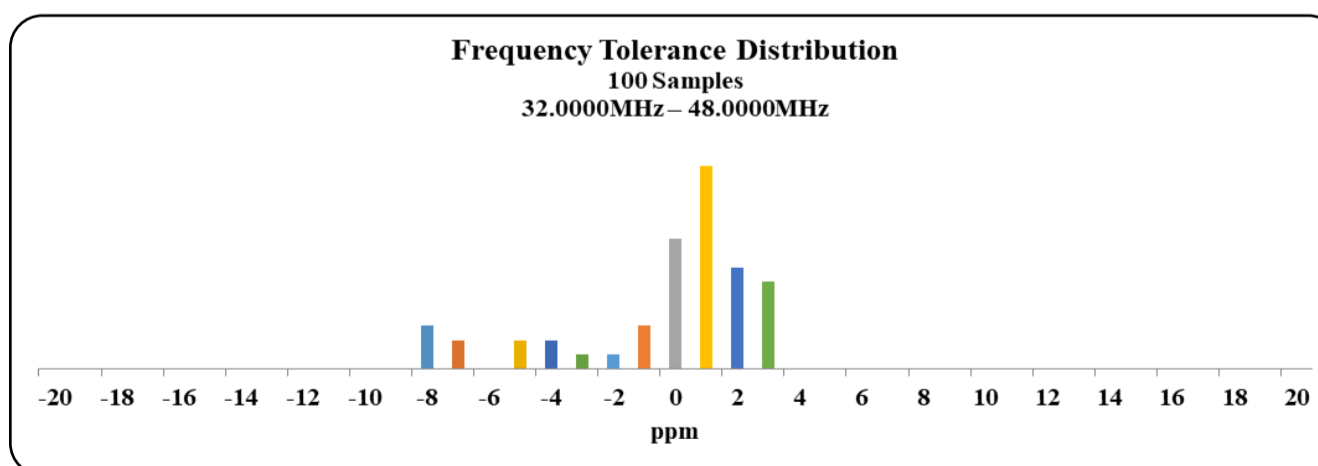

# IoT Optimized Ultra-Miniature Quartz Crystal



ABM13W SERIES



1.20 x 1.00 x 0.33mm  
RoHS/RoHS II Complaint  
MSL = N/A: Not Applicable

## Typical ESR Distribution (at 25°C ± 3°C):



# IoT Optimized Ultra-Miniature Quartz Crystal



ABM13W SERIES



1.20 x 1.00 x 0.33mm  
 RoHS/RoHS II Complaint  
 MSL = N/A: Not Applicable

## Mechanical Dimensions



**Top View**



## Recommended Land Pattern

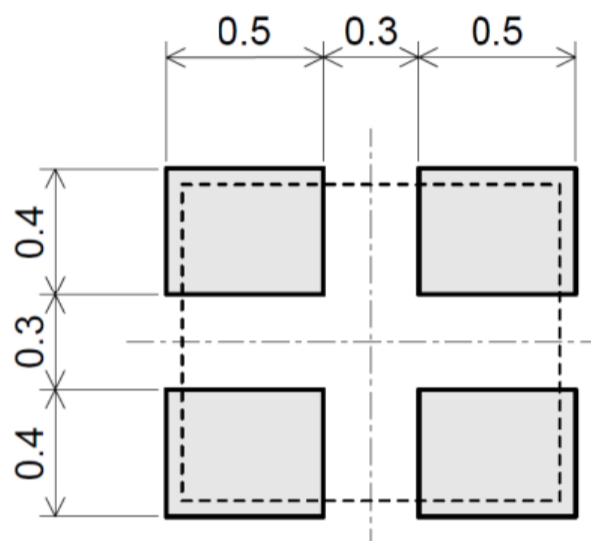

**Bottom View**

## Internal connection

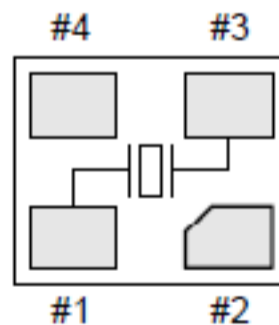

Pin #2: GND (Electrically connected to metallic package lid)  
 Pin #4: NC (No internal connection, leave floating or connect to GND)

Dimensions: mm



5101 Hidden Creek Ln Spicewood TX 78669  
 Phone: 512-371-6159 | Fax: 512-351-8858  
 For terms and conditions of sales, please visit:  
[www.abracon.com](http://www.abracon.com)

REVISED: 02.17.2020

ABRACON IS  
 ISO9001-2015  
 CERTIFIED

# IoT Optimized Ultra-Miniature Quartz Crystal



ABM13W SERIES



1.20 x 1.00 x 0.33mm  
 RoHS/RoHS II Complaint  
 MSL = N/A: Not Applicable

## Reflow Profile



Zone	Description	Temperature	Time
1	Preheat / Soak	$T_{SMIN} \sim T_{SMAX}$ $160 \pm 10^{\circ}C$	80 ~ 100 sec.
2	Reflow	$T_L$ $220^{\circ}C$	50 ~ 70 sec.
3	Peak heat	$T_p$ $260 \pm 5^{\circ}C$	5 sec. MAX.

# IoT Optimized Ultra-Miniature Quartz Crystal

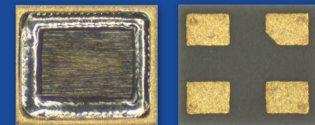

ABM13W SERIES



1.20 x 1.00 x 0.33mm  
 RoHS/RoHS II Complaint  
 MSL = N/A: Not Applicable

## Packaging:

T5: Tape and reel (5,000pcs/reel)

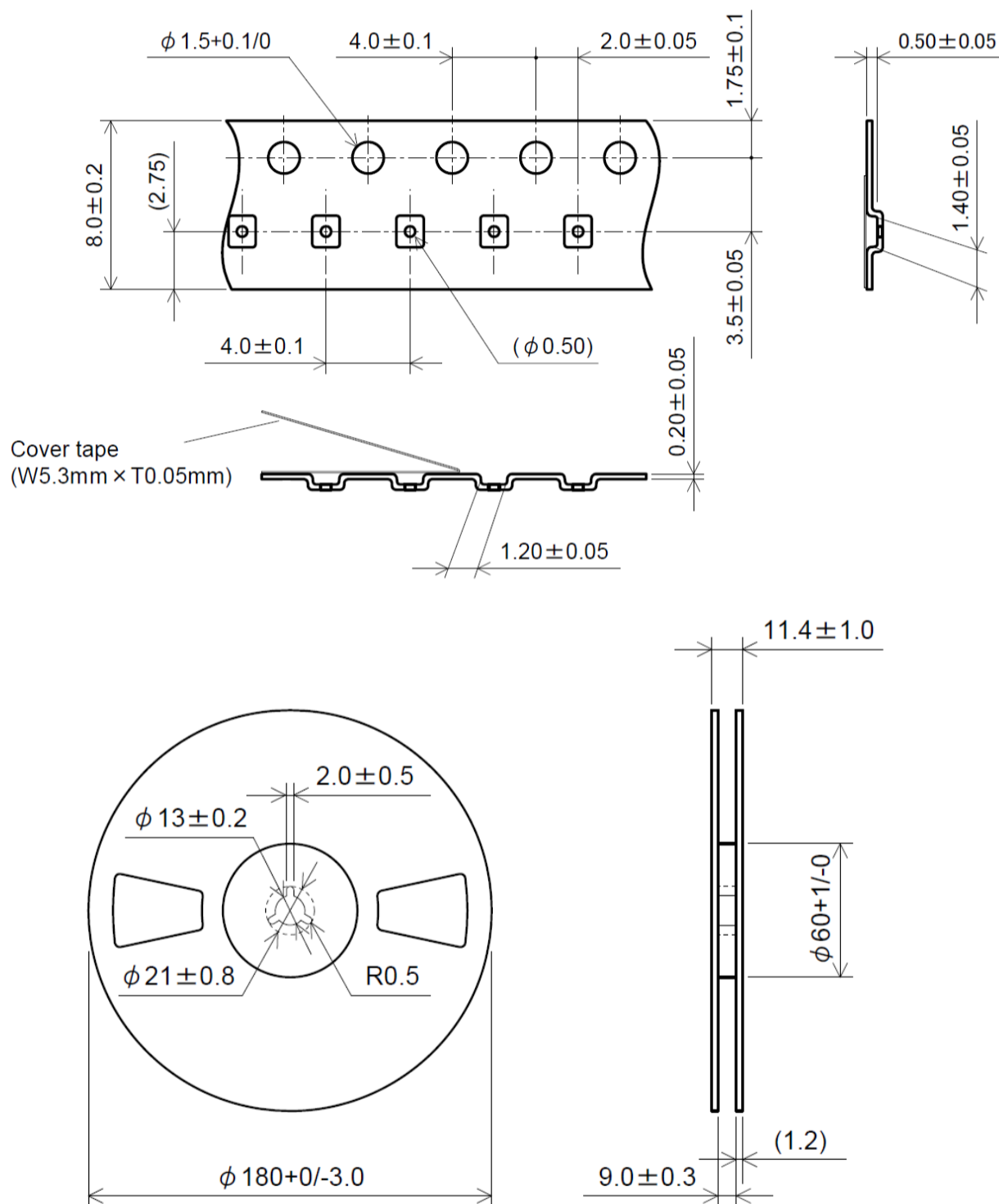

## Dimensions: mm

**ATTENTION:** Abracon LLC's products are COTS – Commercial-Off-The-Shelf products; suitable for Commercial, Industrial and, where designated, Automotive Applications. Abracon's products are not specifically designed for Military, Aviation, Aerospace, Life-dependant Medical applications or any application requiring high reliability where component failure could result in loss of life and/or property. For applications requiring high reliability and/or presenting an extreme operating environment, written consent and authorization from Abracon LLC is required. Please contact Abracon LLC for more information.



5101 Hidden Creek Ln Spicewood TX 78669  
 Phone: 512-371-6159 | Fax: 512-351-8858  
 For terms and conditions of sales, please visit:  
[www.abracon.com](http://www.abracon.com)

REVISED: 02.17.2020

ABRACON IS  
 ISO9001-2015  
 CERTIFIED



# Mouser Electronics

Authorized Distributor

Click to View Pricing, Inventory, Delivery & Lifecycle Information:

## ABRACON:

[ABM13W-32.0000MHZ-8-NH7Y-T5](#) [ABM13W-48.0000MHZ-8-JH7Y-T5](#) [ABM13W-37.4000MHZ-8-BH7Z-T5](#)  
[ABM13W-45.0000MHZ-8-N1U-T5](#) [ABM13W-45.0000MHZ-5-B1Z-T5](#) [ABM13W-40.0000MHZ-8-DH7X-T5](#) [ABM13W-60.0000MHZ-7-B2U-T5](#) [ABM13W-48.0000MHZ-7-D2G-T5](#) [ABM13W-80.0000MHZ-5-B2Z-T5](#) [ABM13W-45.0000MHZ-7-K2Z-T5](#) [ABM13W-52.0000MHZ-8-D1X-T5](#) [ABM13W-45.0000MHZ-8-B2U-T5](#) [ABM13W-60.0000MHZ-5-B2Y-T5](#)  
[ABM13W-80.0000MHZ-8-D2Z-T5](#) [ABM13W-76.8000MHZ-5-NH7U-T5](#) [ABM13W-40.0000MHZ-6-B1Y-T5](#) [ABM13W-45.0000MHZ-5-J1Y-T5](#) [ABM13W-45.0000MHZ-7-DH7Y-T5](#) [ABM13W-32.0000MHZ-6-B2U-T5](#) [ABM13W-32.0000MHZ-5-BH7Z-T5](#) [ABM13W-45.0000MHZ-5-N1G-T5](#) [ABM13W-52.0000MHZ-7-N2Y-T5](#) [ABM13W-80.0000MHZ-6-D1G-T5](#)  
[ABM13W-80.0000MHZ-7-J2Z-T5](#) [ABM13W-80.0000MHZ-7-B2G-T5](#) [ABM13W-60.0000MHZ-7-NH7U-T5](#) [ABM13W-32.0000MHZ-8-B1Z-T5](#) [ABM13W-80.0000MHZ-5-J1Y-T5](#) [ABM13W-60.0000MHZ-5-N1Z-T5](#) [ABM13W-37.4000MHZ-8-B1G-T5](#) [ABM13W-37.4000MHZ-8-K2Z-T5](#) [ABM13W-38.4000MHZ-6-B2Z-T5](#) [ABM13W-45.0000MHZ-6-N2U-T5](#)  
[ABM13W-40.0000MHZ-8-D2G-T5](#) [ABM13W-80.0000MHZ-5-N2G-T5](#) [ABM13W-37.4000MHZ-8-B2Z-T5](#) [ABM13W-60.0000MHZ-8-D2Y-T5](#) [ABM13W-32.0000MHZ-7-N1U-T5](#) [ABM13W-76.8000MHZ-5-B1Z-T5](#) [ABM13W-76.8000MHZ-5-BH7Y-T5](#) [ABM13W-76.8000MHZ-6-J2Z-T5](#) [ABM13W-48.0000MHZ-8-N2Z-T5](#) [ABM13W-40.0000MHZ-6-NH7G-T5](#)  
[ABM13W-40.0000MHZ-7-B1Z-T5](#) [ABM13W-48.0000MHZ-6-D2Z-T5](#) [ABM13W-76.8000MHZ-6-B2G-T5](#) [ABM13W-52.0000MHZ-7-D2G-T5](#) [ABM13W-52.0000MHZ-7-N2U-T5](#) [ABM13W-32.0000MHZ-5-B2G-T5](#) [ABM13W-32.0000MHZ-8-N1X-T5](#) [ABM13W-48.0000MHZ-8-N2X-T5](#) [ABM13W-40.0000MHZ-8-N2U-T5](#) [ABM13W-52.0000MHZ-8-N2X-T5](#)  
[ABM13W-38.4000MHZ-5-B1U-T5](#) [ABM13W-48.0000MHZ-8-D2X-T5](#) [ABM13W-37.4000MHZ-5-J2Z-T5](#) [ABM13W-38.4000MHZ-6-B2X-T5](#) [ABM13W-32.0000MHZ-7-NH7G-T5](#) [ABM13W-32.0000MHZ-8-J1Y-T5](#) [ABM13W-80.0000MHZ-8-JH7Y-T5](#) [ABM13W-76.8000MHZ-8-KH7Z-T5](#) [ABM13W-45.0000MHZ-7-B2Z-T5](#) [ABM13W-45.0000MHZ-5-DH7Y-T5](#)  
[ABM13W-60.0000MHZ-5-JH7Y-T5](#) [ABM13W-60.0000MHZ-7-B1Z-T5](#) [ABM13W-45.0000MHZ-7-JH7Z-T5](#) [ABM13W-48.0000MHZ-5-B2X-T5](#) [ABM13W-76.8000MHZ-7-J2Y-T5](#) [ABM13W-40.0000MHZ-8-BH7G-T5](#) [ABM13W-80.0000MHZ-7-NH7X-T5](#) [ABM13W-38.4000MHZ-5-DH7X-T5](#) [ABM13W-80.0000MHZ-7-BH7Z-T5](#) [ABM13W-37.4000MHZ-6-N2X-T5](#)  
[ABM13W-45.0000MHZ-8-K1Z-T5](#) [ABM13W-60.0000MHZ-6-NH7Z-T5](#) [ABM13W-80.0000MHZ-8-D1G-T5](#) [ABM13W-38.4000MHZ-7-K1Z-T5](#) [ABM13W-76.8000MHZ-5-N2Z-T5](#) [ABM13W-48.0000MHZ-6-N1Z-T5](#) [ABM13W-60.0000MHZ-8-J1Z-T5](#) [ABM13W-76.8000MHZ-5-BH7U-T5](#) [ABM13W-45.0000MHZ-8-NH7U-T5](#) [ABM13W-32.0000MHZ-7-D2Y-T5](#)  
[ABM13W-60.0000MHZ-6-N2G-T5](#) [ABM13W-40.0000MHZ-5-N1X-T5](#) [ABM13W-37.4000MHZ-8-J1Y-T5](#) [ABM13W-80.0000MHZ-5-D1X-T5](#) [ABM13W-37.4000MHZ-7-DH7Z-T5](#) [ABM13W-45.0000MHZ-6-KH7Z-T5](#) [ABM13W-37.4000MHZ-6-B1G-T5](#) [ABM13W-52.0000MHZ-7-B2Y-T5](#) [ABM13W-45.0000MHZ-7-N2G-T5](#) [ABM13W-48.0000MHZ-5-NH7X-T5](#) [ABM13W-60.0000MHZ-8-N1Y-T5](#) [ABM13W-38.4000MHZ-6-NH7X-T5](#) [ABM13W-48.0000MHZ-8-N1X-T5](#)



Компания «ЭлектроПласт» предлагает заключение долгосрочных отношений при поставках импортных электронных компонентов на взаимовыгодных условиях!

Наши преимущества:

- Оперативные поставки широкого спектра электронных компонентов отечественного и импортного производства напрямую от производителей и с крупнейших мировых складов;
- Поставка более 17-ти миллионов наименований электронных компонентов;
- Поставка сложных, дефицитных, либо снятых с производства позиций;
- Оперативные сроки поставки под заказ (от 5 рабочих дней);
- Экспресс доставка в любую точку России;
- Техническая поддержка проекта, помощь в подборе аналогов, поставка прототипов;
- Система менеджмента качества сертифицирована по Международному стандарту ISO 9001;
- Лицензия ФСБ на осуществление работ с использованием сведений, составляющих государственную тайну;
- Поставка специализированных компонентов (Xilinx, Altera, Analog Devices, Intersil, Interpoint, Microsemi, Aeroflex, Peregrine, Syfer, Eurofarad, Texas Instrument, Miteq, Cobham, E2V, MA-COM, Hittite, Mini-Circuits, General Dynamics и др.);

Помимо этого, одним из направлений компании «ЭлектроПласт» является направление «Источники питания». Мы предлагаем Вам помощь Конструкторского отдела:

- Подбор оптимального решения, техническое обоснование при выборе компонента;
- Подбор аналогов;
- Консультации по применению компонента;
- Поставка образцов и прототипов;
- Техническая поддержка проекта;
- Защита от снятия компонента с производства.



#### Как с нами связаться

**Телефон:** 8 (812) 309 58 32 (многоканальный)

**Факс:** 8 (812) 320-02-42

**Электронная почта:** [org@eplast1.ru](mailto:org@eplast1.ru)

**Адрес:** 198099, г. Санкт-Петербург, ул. Калинина, дом 2, корпус 4, литера А.