

# Three phase full Bridge

with Trench MOSFETs  
in DCB-isolated high-current package

$V_{DSS} = 100\text{ V}$   
 $I_{D25} = 120\text{ A}$   
 $R_{DSon\ typ.} = 3.2\text{ m}\Omega$

**Part number**  
**MTI85W100GC**

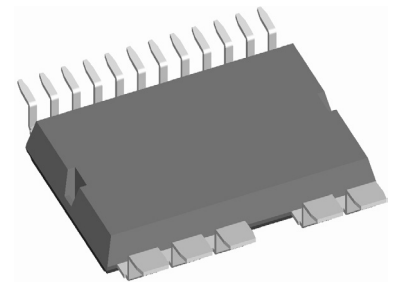

Surface Mount Device

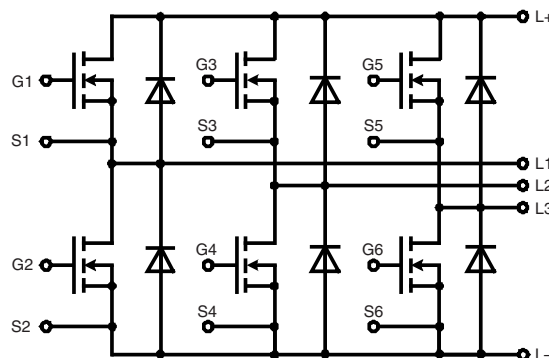

### Features / Advantages:

- MOSFETs in trench technology:
  - low  $R_{DSon}$
  - optimized intrinsic reverse diode
- Package:
  - high level of integration
  - high current capability (300 A max.)
  - aux. terminals for MOSFET control
  - terminals for soldering or welding connections
  - isolated DCB ceramic base plate with optimized heat transfer
- Space and weight savings

### Applications:

- AC drives
  - in automobiles
    - electric power steering
    - starter generator
  - in industrial vehicles
    - propulsion drives
    - fork lift drives
- in battery supplied equipment

### Package: ISOPLUS-DIL®

- High level of integration
- RoHS compliant
- High current capability
- Aux. Terminals for MOSFET control
- Terminals for soldering or welding connections
- Space and weight savings

### Terms & Conditions of usage

The data contained in this product data sheet is exclusively intended for technically trained staff. The user will have to evaluate the suitability of the product for the intended application and the completeness of the product data with respect to his application. The specifications of our components may not be considered as an assurance of component characteristics. The information in the valid application- and assembly notes must be considered. Should you require product information in excess of the data given in this product data sheet or which concerns the specific application of your product, please contact your local sales office.

Due to technical requirements our product may contain dangerous substances. For information on the types in question please contact your local sales office.

Should you intend to use the product in aviation, in health or life endangering or life support applications, please notify. For any such application we urgently recommend

- to perform joint risk and quality assessments;

- the conclusion of quality agreements;

- to establish joint measures of an ongoing product survey, and that we may make delivery dependent on the realization of any such measures.

IXYS reserves the right to change limits, test conditions and dimensions.

20170614g

MOSFETs				Ratings		
Symbol	Definitions	Conditions	min.	typ.	max.	Unit
$V_{DSS}$	drain source breakdown voltage	$T_{VJ} = 25^{\circ}\text{C to } 150^{\circ}\text{C}$			100	V
$V_{GS}$	gate source voltage				$\pm 15$	V
$V_{GSM}$	max. transient gate source voltage				$\pm 20$	V
$I_{D25}$	continuous drain current	$T_C = 25^{\circ}\text{C}$			120	A
$I_{D90}$		$T_C = 90^{\circ}\text{C}$			90	A
$I_{F25}$	forward current	$T_C = 25^{\circ}\text{C}$				A
$I_{F90}$		$T_C = 90^{\circ}\text{C}$				A
$R_{DS(on)}^{1)}$	static drain source on resistance	on-chip level at $I_D = 80 \text{ A}; V_{GS} = 10 \text{ V}$	$T_{VJ} = 25^{\circ}\text{C}$ $T_{VJ} = 125^{\circ}\text{C}$	3.2 5.4	4	$\text{m}\Omega$ $\text{m}\Omega$
$V_{GS(th)}$	gate threshold voltage	$I_D = 150 \mu\text{A}; V_{DS} = V_{GS}$	$T_{VJ} = 25^{\circ}\text{C}$	2.0	3.5	V
$I_{DSS}$	drain source leakage current	$V_{DS} = V_{DSS}; V_{GS} = 0 \text{ V}$	$T_{VJ} = 25^{\circ}\text{C}$ $T_{VJ} = 125^{\circ}\text{C}$		1 100	$\mu\text{A}$ $\mu\text{A}$
$I_{GSS}$	gate source leakage current	$V_{GS} = \pm 20 \text{ V}; V_{DS} = 0 \text{ V}$			500	nA
$R_G$	gate resistance	on-chip level				$\Omega$
$Q_g$	total gate charge	} $V_{GS} = 10 \text{ V}; V_{DS} = 50 \text{ V}; I_D = 80 \text{ A}$		88		nC
$Q_{gs}$	gate source charge			30		nC
$Q_{gd}$	gate drain (Miller) charge			18		nC
$t_{d(on)}$	turn-on delay time	} inductive load $V_{GS} = 10 \text{ V}; V_{DS} = 50 \text{ V}$ $I_D = 80 \text{ A}; R_G = 39 \Omega$	$T_{VJ} = 125^{\circ}\text{C}$		90	ns
$t_r$	current rise time				55	ns
$t_{d(off)}$	turn-off delay time				480	ns
$t_f$	current fall time				40	ns
$E_{on}$	turn-on energy per pulse				130	$\mu\text{J}$
$E_{off}$	turn-off energy per pulse				390	$\mu\text{J}$
$E_{rec(off)}$	turn-off reverse recovery losses		10	$\mu\text{J}$		
$R_{thJC}$	thermal resistance junction to case				1.2	K/W
$R_{thJH}$	thermal resistance junction to heatsink	with heat transfer paste (IXYS test setup)		1.5		K/W
$^{1)} V_{DS} = I_D \cdot (R_{DS(on)} + 2 \cdot R_{Pin \text{ to Chip}})$						
Source-Drain Diode						
$V_{SD}$	source drain voltage	$I_F = 80 \text{ A}; V_{GS} = 0 \text{ V}$	$T_{VJ} = 25^{\circ}\text{C}$	0.9	1.2	V
$Q_{RM}$	reverse recovery charge	} $V_R = 50 \text{ V}; I_F = 80 \text{ A}; R_G = 39 \Omega$ $di/dt = 1500 \text{ A}/\mu\text{s}$	$T_{VJ} = 125^{\circ}\text{C}$		1.3	$\mu\text{C}$
$I_{RM}$	max. reverse recovery current				44	A
$t_{rr}$	reverse recovery time				45	ns

Package ISOPLUS-DIL®			Ratings			
Symbol	Definitions	Conditions	min.	typ.	max.	Unit
$I_{RMS}$	RMS current	per pin in main current paths (P+, N-, L1, L2, L3) may be additionally limited by external connections (PCB tracks)			300	A
$T_{stg}$	storage temperature		-55		125	°C
$T_{op}$	operation temperature		-55		150	°C
$T_{vJ}$	virtual junction temperature		-55		175	°C
$V_{ISOL}$	isolation voltage	$t = 1$ second	50/60 Hz, RMS, $I_{ISOL} \leq 1$ mA	1200		V
		$t = 1$ minute		1000		V
$R_{pin-chip}$	resistance terminal to chip	$V_{DS} = I_D \cdot (R_{DS(on)} + 2 \cdot R_{pin\ to\ chip})$		0.6		mΩ
$C_p$	coupling capacity	between shorted pins and back side metallization		160		pF
$F_c$	mounting force with clip		50		250	N
<b>Weight</b>				13		g

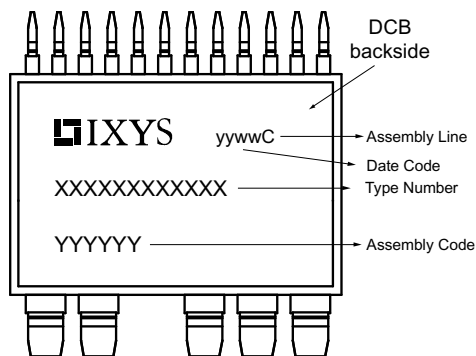
**Part number**

- M = MOSFET
- T = Trench
- I = Infineon Trench
- 85 = Current Rating [A]
- W = 6-Pack
- 100 = Reverse Voltage [V]
- GC = ISOPLUS-DIL

Ordering	Part Name	Marking on Product	Delivering Mode	Base Qty	Ordering Code
Standard	MTI85W100GC-SMD	MTI85W100GC	Tube	13	516941

**Outlines ISOPLUS-DIL®**

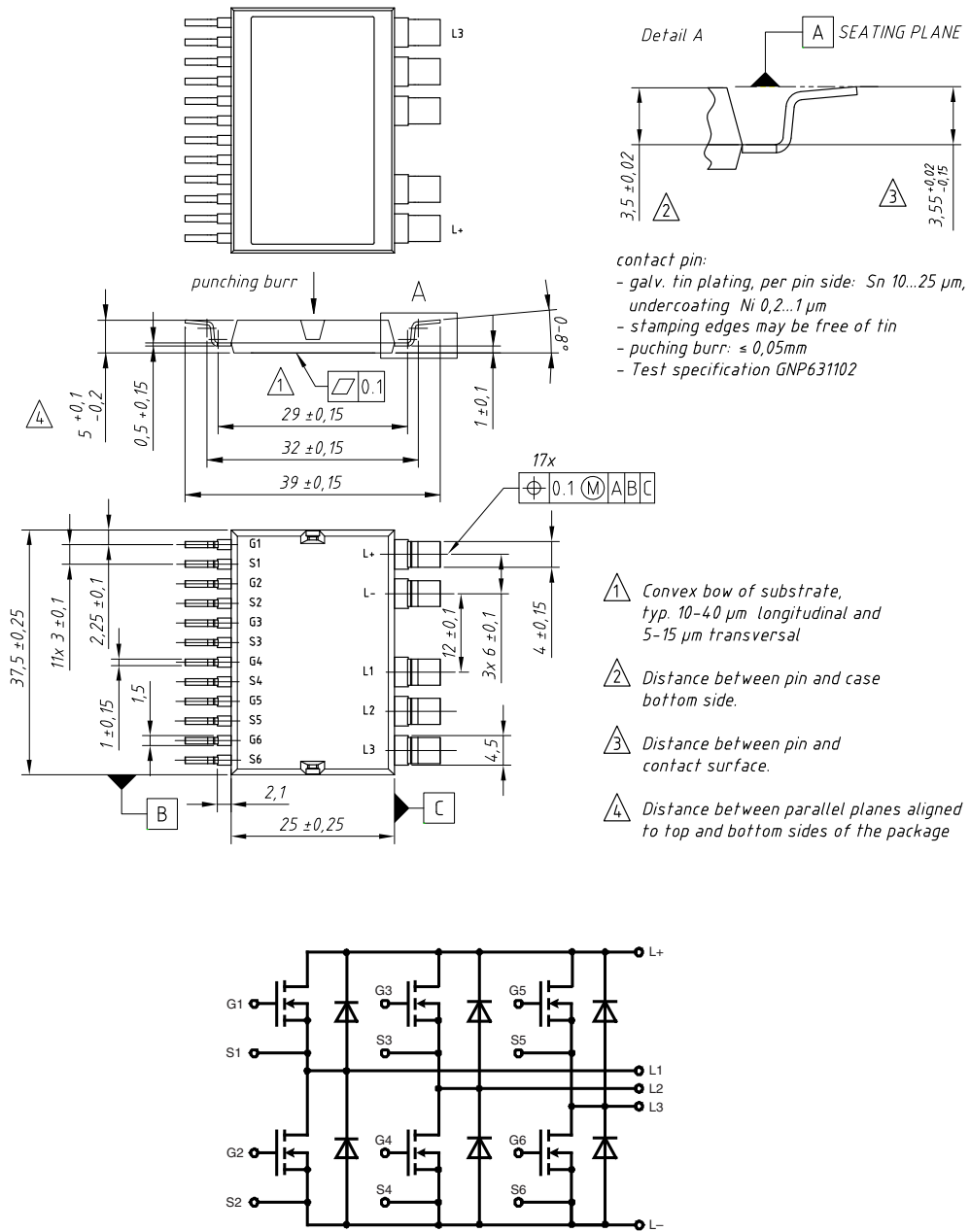

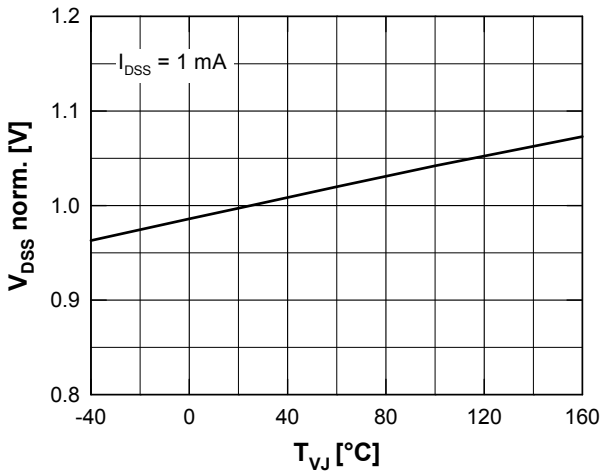

Fig. 1 Drain source breakdown voltage  $V_{DSS}$  vs. junction temperature  $T_{VJ}$

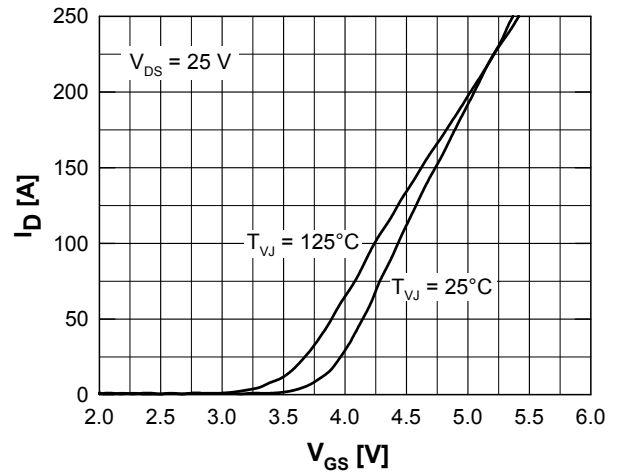

Fig. 2 Typ. transfer characteristics

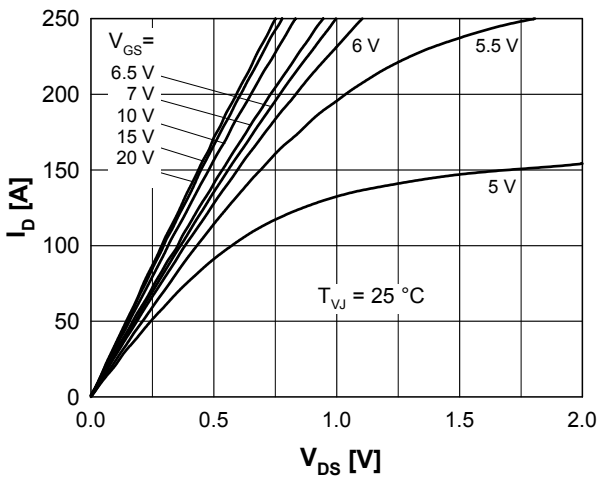

Fig. 3 Typ. output characteristics (25  $^{\circ}C$ )

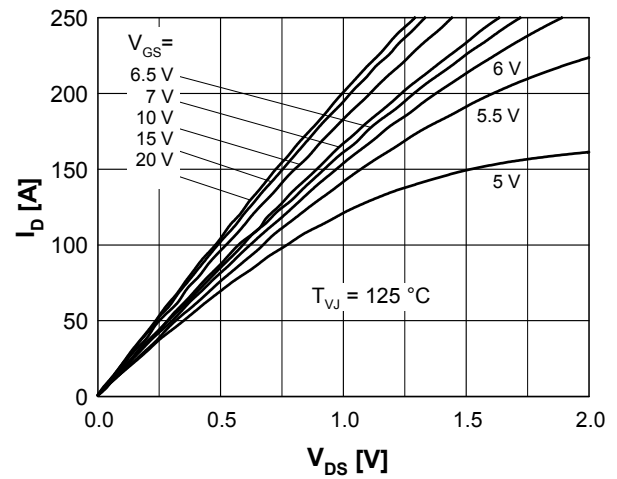

Fig. 4 Typ. output characteristics (125  $^{\circ}C$ )

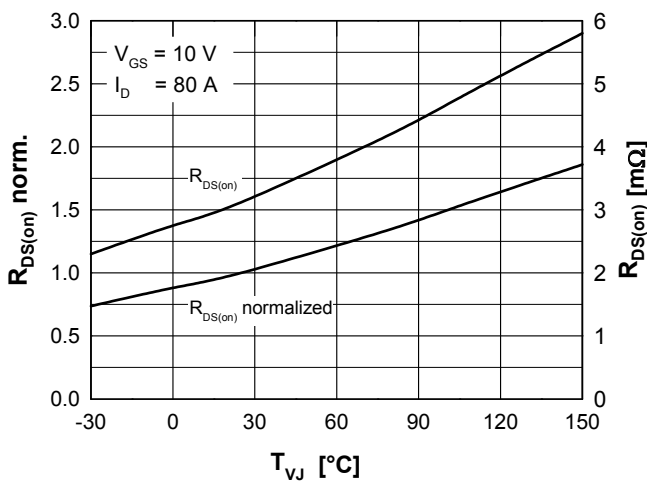

Fig. 5 Drain source on-state resistance versus junction temperature

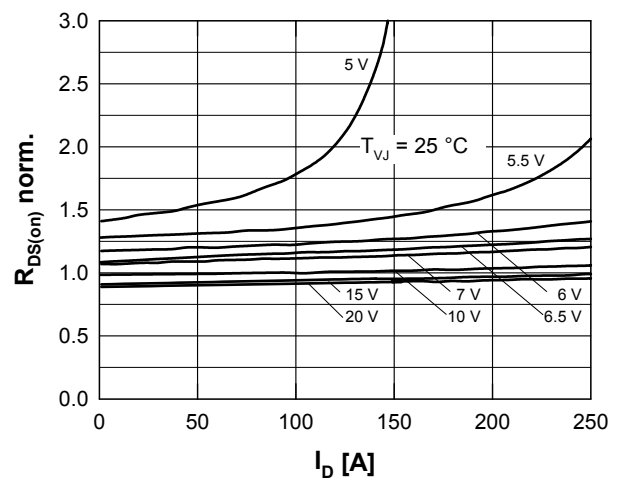

Fig. 6 Drain source on-state resistance versus  $I_D$

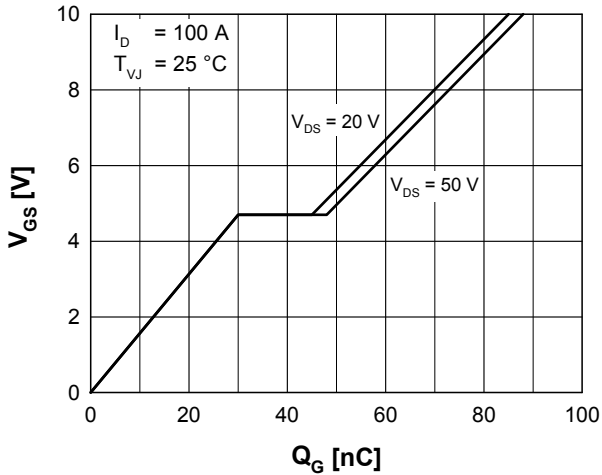

Fig. 7 Typical turn on gate charge

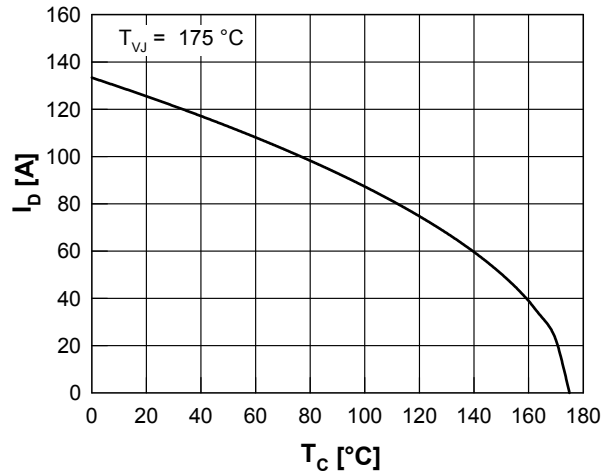

Fig. 8 Drain current  $I_D$  vs. case temperature  $T_C$  (chip capability)

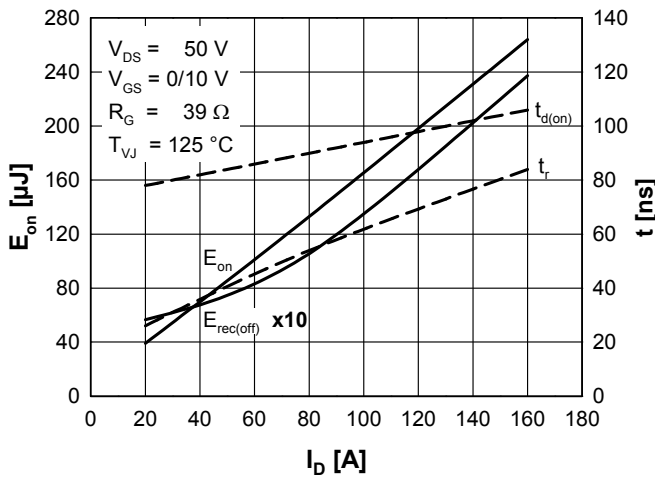

Fig. 9 Typ. turn-on energy and switching times versus drain current, inductive switching

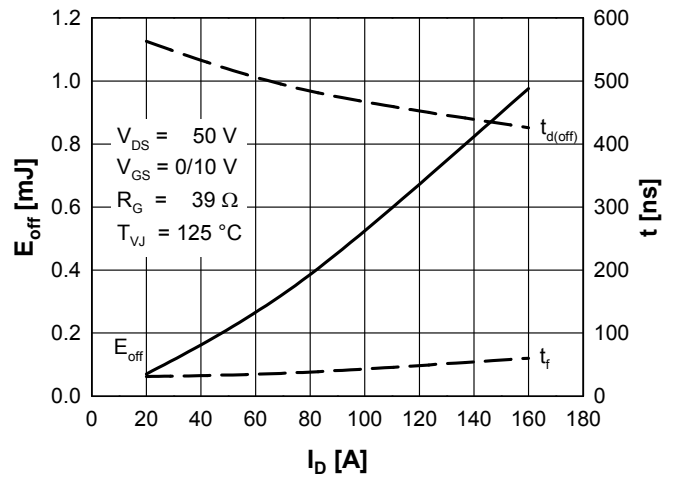

Fig. 10 Typ. turn-off energy and switching times versus drain-current, inductive switching

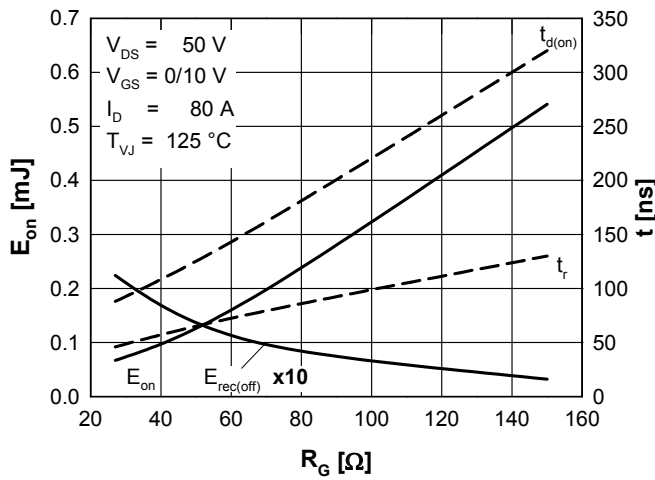

Fig. 11 Typ. turn-on energy and switching times versus gate resistor, inductive switching

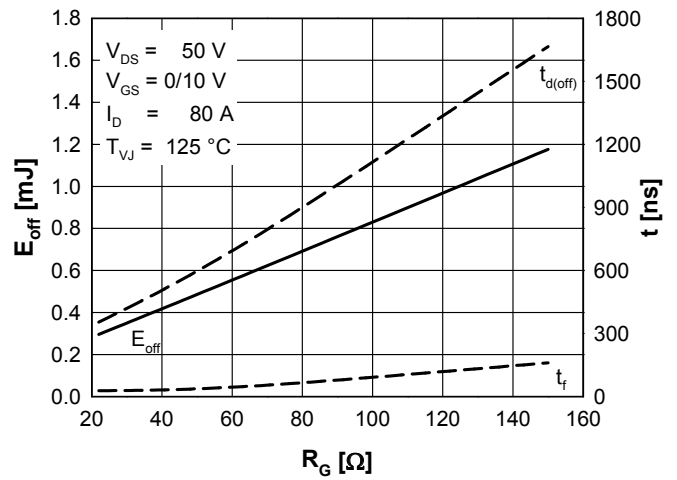

Fig. 12 Typ. turn-off energy and switching times versus gate resistor, inductive switching

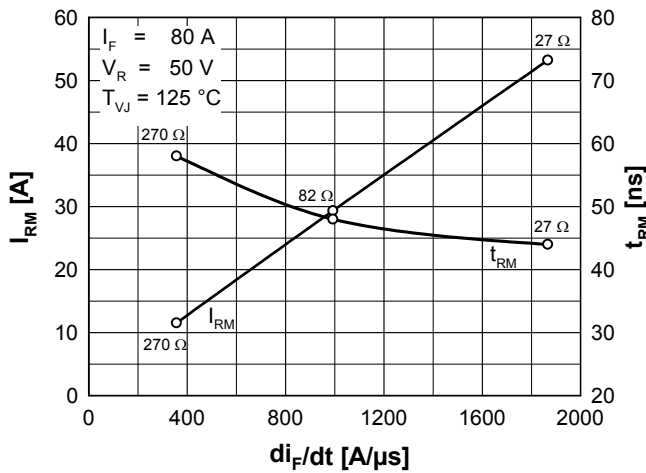

Fig. 13 Reverse recovery time  $t_{RM}$  of the body diode vs.  $di_F/dt$

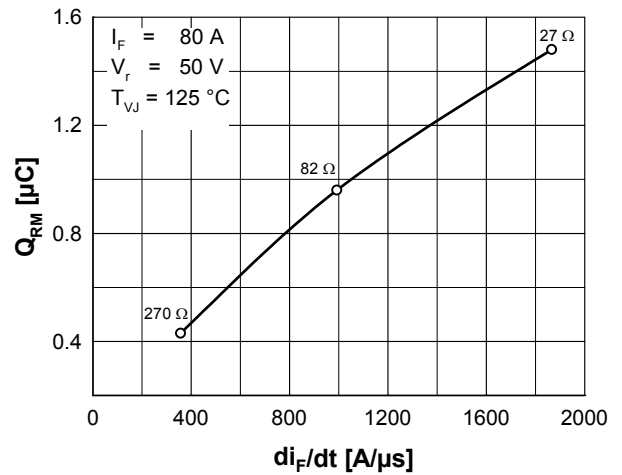

Fig. 14 Reverse recovery charge  $Q_{RM}$  of the body diode vs.  $di_F/dt$

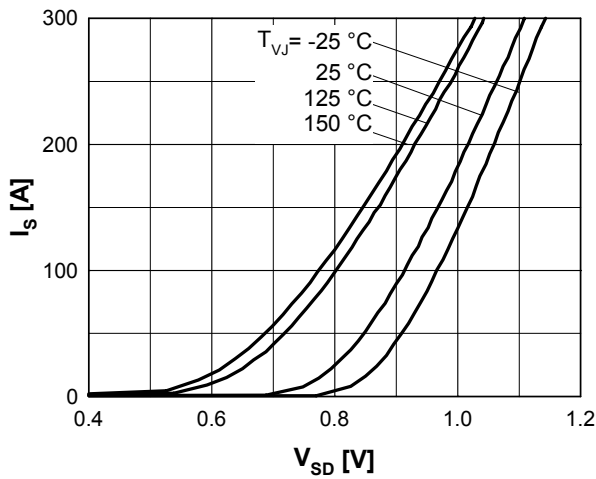

Fig.15 Source current  $I_S$  vs. source drain voltage  $V_{SD}$  (body diode)

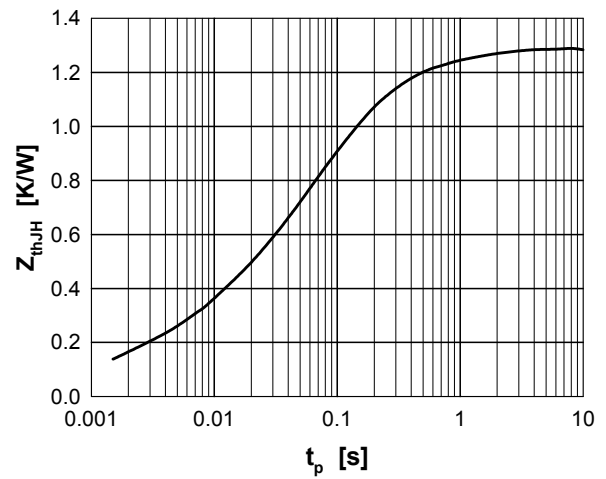

Fig. 16 Typ. thermal impedance junction to heatsink  $Z_{thJH}$  with heat transfer paste (IXYS test setup)

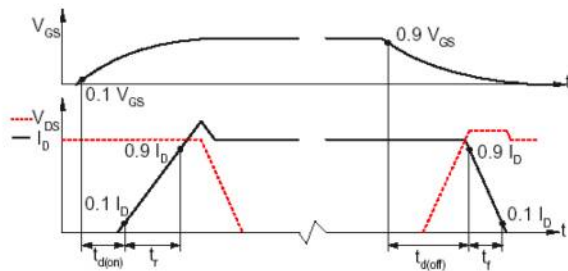

Fig. 17 Definition of switching times



Компания «ЭлектроПласт» предлагает заключение долгосрочных отношений при поставках импортных электронных компонентов на взаимовыгодных условиях!

Наши преимущества:

- Оперативные поставки широкого спектра электронных компонентов отечественного и импортного производства напрямую от производителей и с крупнейших мировых складов;
- Поставка более 17-ти миллионов наименований электронных компонентов;
- Поставка сложных, дефицитных, либо снятых с производства позиций;
- Оперативные сроки поставки под заказ (от 5 рабочих дней);
- Экспресс доставка в любую точку России;
- Техническая поддержка проекта, помощь в подборе аналогов, поставка прототипов;
- Система менеджмента качества сертифицирована по Международному стандарту ISO 9001;
- Лицензия ФСБ на осуществление работ с использованием сведений, составляющих государственную тайну;
- Поставка специализированных компонентов (Xilinx, Altera, Analog Devices, Intersil, Interpoint, Microsemi, Aeroflex, Peregrine, Syfer, Eurofarad, Texas Instrument, Miteq, Cobham, E2V, MA-COM, Hittite, Mini-Circuits, General Dynamics и др.);

Помимо этого, одним из направлений компании «ЭлектроПласт» является направление «Источники питания». Мы предлагаем Вам помощь Конструкторского отдела:

- Подбор оптимального решения, техническое обоснование при выборе компонента;
- Подбор аналогов;
- Консультации по применению компонента;
- Поставка образцов и прототипов;
- Техническая поддержка проекта;
- Защита от снятия компонента с производства.



#### Как с нами связаться

**Телефон:** 8 (812) 309 58 32 (многоканальный)

**Факс:** 8 (812) 320-02-42

**Электронная почта:** [org@eplast1.ru](mailto:org@eplast1.ru)

**Адрес:** 198099, г. Санкт-Петербург, ул. Калинина, дом 2, корпус 4, литера А.