

# M2C

Indicator (Cylindrical 12-dia.)

CSM\_M2C\_DS\_E\_4\_1

## Indicator with Cylindrical 20-mm × 12-dia. Body

- Same basic design as the A3C Pushbutton Switch.
- Good illumination with even surface brightness.
- Cylindrical body means panel cutouts can be made easily.

RoHS Compliant

Refer to *Safety Precautions for All Pushbutton Switches* and *Safety Precautions for the A3C*.



### List of Models

Appearance	Model
Rectangular	M2CJ
Square	M2CA
Round	M2CT

**Model Number Legend**..... The model numbers used to order sets of Units are illustrated below. One set comprises the Display, Lamp, and Socket Unit. For information on combinations, refer to *Ordering Information*

(1) (2) (3) (4) (5)  
**M 2 C J - 9 0 A 1 - 24 E R**

**(1) Shape of Display**

Symbol	Shape
J	Rectangular
A	Square
T	Round

**(2) Terminal Type**

Symbol	Terminal type
0	Solder terminals

**(3) Lighting Type**

Symbol	Lighting type
1	Illumination only

• Colored-illumination models are also available. For details, refer to page 3.

▶ “Colored-illumination” models operate in the way shown below:

Unlit	Lit
White	Color

The built-in LED is colored.

**(4) Lighting Method**

**LED lamp-lighted Models**

Symbol	Operating voltage
05E	5 VDC
12E	12 VDC
24E	24 VDC

**Incandescent Lamp-lighted Models**

Symbol	Operating voltage
06	5 VAC/VDC
14	12 VAC/VDC
28	24 VAC/VDC

**(5) Color of Display**

**For LED lamp**

Symbol	Color
R	Red
Y	Yellow
G	Green
W	White

**For incandescent lamp**

Symbol	Color
R	Red
Y	Yellow
G	Green
A	Blue
W	White

## Ordering Information

**Ordering as a Set**.....The model numbers used to order sets of Units are given in the following tables.  
One set comprises the Display, Lamp, and Socket Unit.



### Solder Terminals

Appearance	Lighting	Model number (for set)	Display color symbol
Rectangular (M2CJ)	LED lamp	M2CJ-90A1-05E□	R: red Y: yellow G: green W: white
		M2CJ-90A1-12E□	
		M2CJ-90A1-24E□	
	Incandescent lamp	M2CJ-90A1-06□	R: red Y: yellow G: green W: white A: blue
		M2CJ-90A1-14□	
		M2CJ-90A1-28□	
Square (M2CA)	LED lamp	M2CA-90A1-05E□	R: red Y: yellow G: green W: white
		M2CA-90A1-12E□	
		M2CA-90A1-24E□	
	Incandescent lamp	M2CA-90A1-06□	R: red Y: yellow G: green W: white A: blue
		M2CA-90A1-14□	
		M2CA-90A1-28□	
Round (M2CT)	LED lamp	M2CT-90A1-05E□	R: red Y: yellow G: green W: white
		M2CT-90A1-12E□	
		M2CT-90A1-24E□	
	Incandescent lamp	M2CT-90A1-06□	R: red Y: yellow G: green W: white A: blue
		M2CT-90A1-14□	
		M2CT-90A1-28□	

Note: Enter the desired color symbol for the Display in the □ at the end of the model number.

Individual models: Refer to pages 4 to 5.  
(The Display, Lamp, and Socket Unit can be ordered separately.)

■ Ratings: Refer to page 6. ■ Dimensions: Refer to page 7.  
■ Accessories: Refer to the A3C.

## Ordering Information

### Illumination-only and Colored-illumination LED Models

“Illumination only” describes LED models for which the screen color is the same whether the LED is lit or not. The screen simply becomes brighter when the LED lights.

Example: Red LED



“Colored illumination” describes LED models for which the screen color is white when the LED is not lit and changes to the color of the LED lamp when the LED is lit.



Ordering: With colored-illumination models, order the Display, Lamp, and Socket Unit as shown in the following table.

Illuminated color	Display	Lamp (LED)		Socket Unit
Red	IP40 A3C□-500W	<b>A16-□DR</b>	Enter one of the following symbols in □. 5: 5 VDC 12: 12 VDC 24: 24 VDC	Refer to page 5. Order the Socket Unit that is appropriate for the Display.
Yellow	Enter one of the following symbols in □. J: Rectangular A: Square	<b>A16-□DY</b>		
Green	T: Round	<b>A16-□DG</b>		

## Ordering Information

**Ordering Individually** .....Displays, Lamps, and Socket Units can be ordered separately. Combinations that are not available as sets can be created using individual Units. Also, store the parts as spares for maintenance and repairs.

**Ordering: Specify a model number from the following page.**

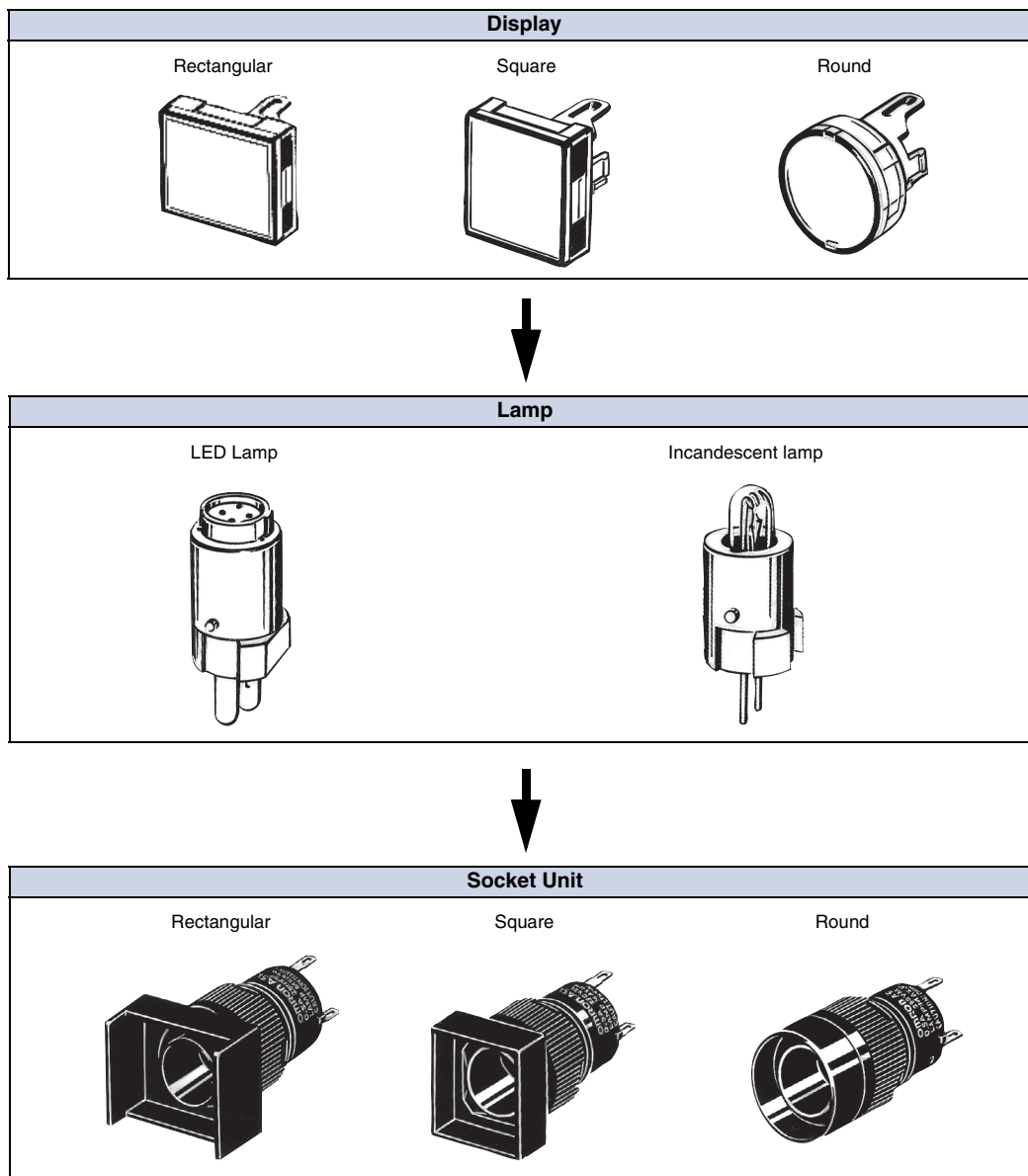

Ordering set combinations: Refer to page 2.



■ Ratings: Refer to page 6. ■ Dimensions: Refer to page 7.  
 ■ Accessories: Refer to the A3C.

## Ordering Information

**Ordering Individually** ..... The Display, Lamp, and Socket Unit can be ordered separately. They can also be used as inventory for maintenance parts.



### Display (Lighted Models)

#### LED Lamp

Appearance	Rectangular	Square	Round
			
<b>Button color</b>			
<b>Red</b>	A3CJ-500R	A3CA-500R	A3CT-500R
<b>Yellow</b>	A3CJ-500Y	A3CA-500Y	A3CT-500Y
<b>Green</b>	A3CJ-500GY	A3CA-500GY	A3CT-500GY
<b>White</b>	A3CJ-500W	A3CA-500W	A3CT-500W

Note: The red, yellow, and white Displays listed above can be used with either LED lamp-lighted models or incandescent lamp-lighted models.

#### Incandescent Lamp

Appearance	Rectangular	Square	Round
			
<b>Button color</b>			
<b>Red</b>	A3CJ-500R	A3CA-500R	A3CT-500R
<b>Yellow</b>	A3CJ-500Y	A3CA-500Y	A3CT-500Y
<b>Green</b>	A3CJ-500G	A3CA-500G	A3CT-500G
<b>White</b>	A3CJ-500W	A3CA-500W	A3CT-500W
<b>Blue</b>	A3CJ-500A	A3CA-500A	A3CT-500A

### Lamp

#### LED Lamp

Rated voltage	Color	Red	Yellow	Green	White
5 VDC		A16-5DR	A16-5DY	A16-5DG	A16-5DW
12 VDC		A16-12DR	A16-12DY	A16-12DG	A16-12DW
24 VDC		A16-24DR	A16-24DY	A16-24DG	A16-24DW

#### Incandescent Lamp

Rated voltage	Model
6 VAC/DC	A16-5
14 VAC/DC	A16-12
28 VAC/DC	A16-24

### Socket Unit

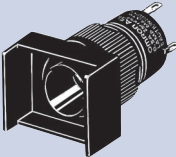
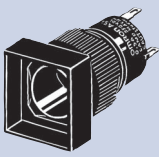
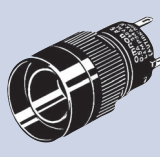
Sealing	IP40		
Appearance	Rectangular	Square	Round
			
<b>Terminal</b>			
<b>Solder terminals</b>	M2CJ-7001	M2CA-7001	M2CT-7001

## Specifications

### Ratings

#### LED Lamp

Rated voltage	Rated current	Operating voltage	Internal limiting resistance
5 VDC	30 mA	5 VDC±5%	33 Ω
12 VDC	15 mA	12 VDC±5%	270 Ω
24 VDC	10 mA	24 VDC±5%	1,600 Ω

#### Incandescent Lamp

Rated voltage	Rated current	Operating voltage
6 VAC/VDC	60 mA	5 VAC/VDC
14 VAC/VDC	40 mA	12 VAC/VDC
28 VAC/VDC	24 mA	24 VAC/VDC

<b>Ambient operating temperature</b>	-10°C to +55°C (with no icing or condensation)
<b>Ambient operating humidity</b>	35% to 85%RH
<b>Ambient storage temperature</b>	-25°C to +65°C

### Approved Standard Ratings

UL (File No. E41515), CSA (File No. LR45258)

LED: 24 VDC max.

Incandescent lamp: 1 W at 28 VDC/VAC

Note: Certification has been obtained for the Indicator.



For detailed information on individual products that have received certification, consult your supplier.

## Nomenclature

### Model Structure

#### Shape of Display

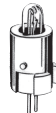

	Type	Specifications
(1)	Shape of Pushbutton Rectangular (M2CJ)    Square (M2CA)    Round (M2CT) 	---
(2)	LED Lamp-lighted Models Red, yellow, green, white Incandescent Lamp-lighted Models Red, yellow, green, white, blue	---
(3)	LED Lamp	
	Incandescent Lamp	

Dimensions

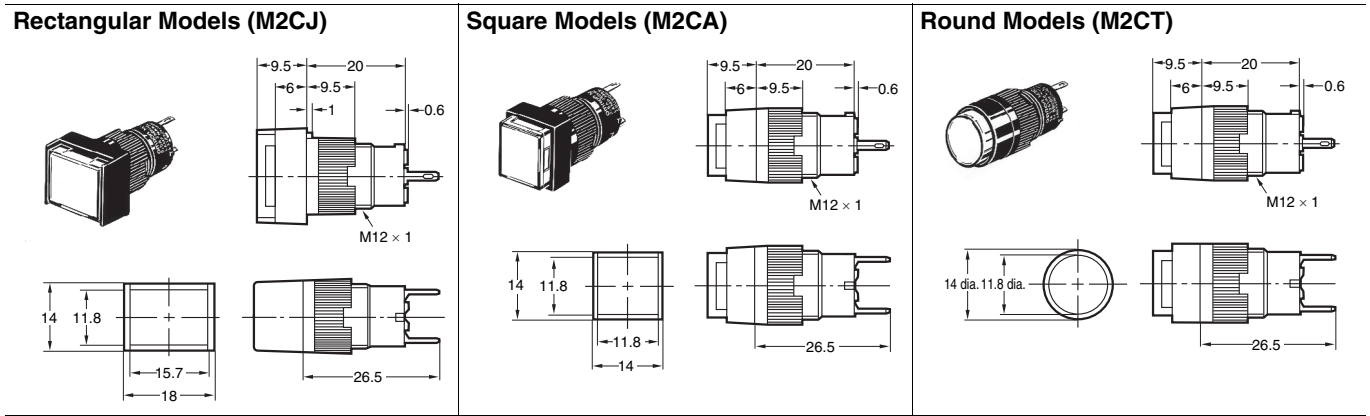

Note: Unless specified, there is a tolerance of  $\pm 0.4$  mm for dimensions.

Terminal Connections

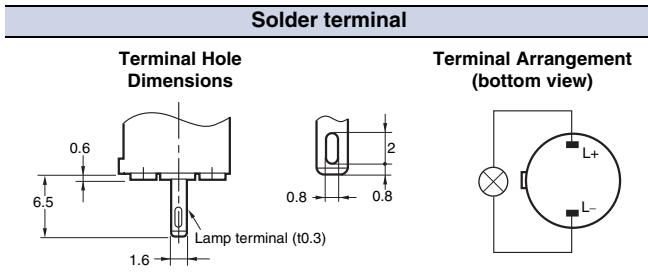

Panel Cutout (Top View)

	Rectangular/M2CJ	Square/M2CA, Round/M2CT
Indicator Unit only	<p>12 dia. <math>^{+0.2}_0</math>, 19 min., 7.5 <math>\pm 0.1</math>, 2 dia. (Lock hole), 5.5 <math>\pm 0.1</math>, 15 min.</p> <p>Note: Recommended panel thickness: 1.0 to 3.2 mm.</p>	<p>12 dia. <math>^{+0.2}_0</math>, 15 min.</p> <p>Note: Recommended panel thickness: 1.0 to 3.2 mm.</p>
With Dust Cover	<p>12 dia. <math>^{+0.2}_0</math>, 22.5 min., 7.5 <math>\pm 0.1</math>, 2 dia., 5.5 <math>\pm 0.1</math>, 19 min.</p>	---

• If the panel is to be finished (e.g., coated), make sure that the panel meets the specified dimensions after the coating.

Accessories, Replacements, and Tools

The accessories, replacements, and tools for the A3C Lighted Pushbutton Switch can also be used with the A3C. Refer to the A3C.

Safety Precautions

Refer to *Safety Precautions for Pushbutton Switches* and *Safety Precautions for the A3C*.

■ Ratings: Refer to page 6. ■ Dimensions: Refer to this page.

- Application examples provided in this document are for reference only. In actual applications, confirm equipment functions and safety before using the product.
- Consult your OMRON representative before using the product under conditions which are not described in the manual or applying the product to nuclear control systems, railroad systems, aviation systems, vehicles, combustion systems, medical equipment, amusement machines, safety equipment, and other systems or equipment that may have a serious influence on lives and property if used improperly. Make sure that the ratings and performance characteristics of the product provide a margin of safety for the system or equipment, and be sure to provide the system or equipment with double safety mechanisms.

**Note: Do not use this document to operate the Unit.**

---

**OMRON Corporation**

**ELECTRONIC AND MECHANICAL COMPONENTS COMPANY**

**Contact: [www.omron.com/ecb](http://www.omron.com/ecb)**

**Cat. No. A206-E1-01  
0812(0207)(O)**





Компания «ЭлектроПласт» предлагает заключение долгосрочных отношений при поставках импортных электронных компонентов на взаимовыгодных условиях!

Наши преимущества:

- Оперативные поставки широкого спектра электронных компонентов отечественного и импортного производства напрямую от производителей и с крупнейших мировых складов;
- Поставка более 17-ти миллионов наименований электронных компонентов;
- Поставка сложных, дефицитных, либо снятых с производства позиций;
- Оперативные сроки поставки под заказ (от 5 рабочих дней);
- Экспресс доставка в любую точку России;
- Техническая поддержка проекта, помощь в подборе аналогов, поставка прототипов;
- Система менеджмента качества сертифицирована по Международному стандарту ISO 9001;
- Лицензия ФСБ на осуществление работ с использованием сведений, составляющих государственную тайну;
- Поставка специализированных компонентов (Xilinx, Altera, Analog Devices, Intersil, Interpoint, Microsemi, Aeroflex, Peregrine, Syfer, Eurofarad, Texas Instrument, Miteq, Cobham, E2V, MA-COM, Hittite, Mini-Circuits, General Dynamics и др.);

Помимо этого, одним из направлений компании «ЭлектроПласт» является направление «Источники питания». Мы предлагаем Вам помощь Конструкторского отдела:

- Подбор оптимального решения, техническое обоснование при выборе компонента;
- Подбор аналогов;
- Консультации по применению компонента;
- Поставка образцов и прототипов;
- Техническая поддержка проекта;
- Защита от снятия компонента с производства.



#### Как с нами связаться

**Телефон:** 8 (812) 309 58 32 (многоканальный)

**Факс:** 8 (812) 320-02-42

**Электронная почта:** [org@eplast1.ru](mailto:org@eplast1.ru)

**Адрес:** 198099, г. Санкт-Петербург, ул. Калинина, дом 2, корпус 4, литера А.