

- Designed small, 2- and 3-pole types break 5 A loads and 4-pole type, 3 A load
- High reliability, long life
- Ultra-high sensitivity with quick response
- High vibration/shock resistance
- 3- and 4-pole types have an arc barrier
- UL and CSA approved
- Withstands dielectric strength of 2,000 V
- Relays with high-capacity, LED indicator, diode surge suppression, push-to-test button, or RC circuit are available
- Changes due to aging are negligible because of use of special magnetic materials, thus ensuring long continuous holding time
- Little change in characteristics such as contact follow, contact pressure, etc., throughout long life



Ordering Information

To Order: Select the part number and add the desired coil voltage rating (e.g., MY4-DC6).

Type	Terminal	Contact form	Construction	Part number							
				Single contact			Bifurcated contact				
				Standard bracket mounting	Upper mounting bracket	Lower mounting bracket	Standard bracket mounting	Upper mounting bracket	Lower mounting bracket		
Standard	Plug-in/solder	DPDT	Unsealed	MY2	MY2F	MY2S	MY2Z	MY2ZF	MY2ZS		
				MY3	MY3F	MY3S	—	—	—		
				MY4	MY4F	MY4S	MY4Z	MY4ZF	MY4ZS		
		PCB		DPDT	MY2-02	—	—	MY2Z-02	—	—	
					MY3-02	—	—	—	—	—	
					MY4-02	—	—	MY2Z-02	—	—	
	Plug-in/solder PCB	4PDT	Sealed	MYQ4	—	—	MYQ4Z	—	—		
				MYQ4-02	—	—	MYQ4Z-02	—	—		
		4PDT		Hermetically Sealed	MY4H	—	—	MY4ZH	—	—	
					MY4H-0	—	—	MY4ZH-0	—	—	
				4PDT	Sealed	MY4H	—	—	MY4ZH	—	—
						MY4H-0	—	—	MY4ZH-0	—	—

- Note: 1. For SEV approved type, order the following: MY4-SV-DC6. (Lloyd's Register approval. See "Approvals" section.)
 2. To order connecting sockets and mounting tracks, see "Accessories" section.
 3. AgCdO contacts are also available (MY2E, MY3E, MY4E). Contact your OMRON sales representative for details.

Ordering information (continued)

Type	Terminal	Contact form	Construction	Part number					
				Single contact			Bifurcated contact		
				Standard bracket mounting	Upper mounting bracket	Lower mounting bracket	Standard bracket mounting	Upper mounting bracket	Lower mounting bracket
LED indicator	Plug-in/solder	DPDT		MY2N	—	—	MY2ZN	—	—
		3PDT		MY3N	—	—	—	—	—
		4PDT		MY4N	—	—	MY4ZN	—	—
High-capacity		DPDT	w/o LED indicator	MY2-Y	—	—	—	—	—
			LED indicator	MY2N-Y	—	—	—	—	—
Diode surge suppression*		DPDT		MY2-D	—	—	MY2Z-D	—	—
		3PDT		MY3-D	—	—	—	—	—
		4PDT		MY4-D	—	—	MY4Z-D	—	—
LED indicator and diode surge suppression*		DPDT		MY2N-D2	—	—	MY2ZN-D2	—	—
		3PDT		MY3N-D2	—	—	—	—	—
		4PDT		MY4N-D2	—	—	MY4ZN-D2	—	—
RC circuit**		DPDT	w/o LED indicator	MY2-CR	—	—	MY2Z-CR	—	—
				MY3-CR	—	—	—	—	—
				MY4-CR	—	—	MY4Z-CR	—	—
		4PDT	LED indicator	MY2N-CR	—	—	—	—	—
				MY4N-CR	—	—	—	—	—
Push-to-test button		DPDT		MY214	—	—	MY2Z12	—	—
		4PDT		MY414	—	—	MY4Z12	—	—
LED indicator and RC circuit		DPDT		MY214N	—	—	MY2Z12N	—	—
		4PDT		MY414N	—	—	MY4Z12N	—	—

Type	Terminal	Contact form	Part number
Latching	Plug-in PC board	DPDT	MY2K-US
			MY2K-02-US

- Note: 1. For SEV approved type, order as the following: MY4-SV-DC6. (Lloyd's Register approval. See "Approvals" section.)
 2. To order connecting sockets and mounting tracks, see "Accessories" section.
 3. AgCdO contacts are also available. Contact your OMRON sales representative for details.
 4. * DC coils only
 ** AC coils only

■ ACCESSORIES

Connecting Sockets

To Order: Select the appropriate part numbers for sockets, clips, and mounting tracks (if required) from the available types chart.

Available Types

Track mounted sockets

Relay	Socket*	Relay hold-down clip		Mounting track
		Standard	RC circuit	
DPDT	PYF08A-E	PYC-A1	Y92-H3	PFP-100N/PFP-50N & PFP-M or PFP-100N2 PFP-S (Optional spacer)
3PDT	PYF11A			
4PDT	PYF14A-E			

* Track mounted socket can be used as a front connecting socket.

Back connecting sockets

Relay	Solder terminal socket	Wire wrap terminal socket	Relay hold-down clip				Socket Mounting Plate		
			Standard	Push-to-test	RC circuit	Mtg. plate	1	18	36
DPDT	PY08	PY08QN	PYC-P	PYC-P2	PYC-1	PYC-S	PYP-1	PYP-18	PYP-36
3PDT	PY11	PY11QN							
4PDT	PY14	PY14QN							

Note: Types PYP-18, PTP-12 and PTP-10 may be cut to any desired length.

Relay	PC terminal socket	Relay hold-down clip		
		Standard	Push-to-test	RC circuit
DPDT	PY08-02	PYC-P	PYC-P2	PYC-1
3PDT	PY11-02			
4PDT	PY14-02			

Specifications

■ CONTACT DATA

Non-latching – Unsealed

Load	DPDT, 3PDT		4DPT		High-capacity	
	Resistive load (p.f. = 1)	Inductive load (p.f. = 0.4) (L/R = 7 ms)	Resistive load (p.f. = 1)	Inductive load (p.f. = 0.4) (L/R = 7 ms)	Resistive load (p.f. = 1)	Inductive load (p.f. = 0.4) (L/R = 7 ms)
Rated load	5 A at 220 VAC 5 A at 24 VDC	2 A at 220 VAC 2 A at 24 VDC	3 A at 220 VAC 3 A at 24 VDC	0.8 A at 220 VAC 1.5 A at 24 VDC	7 A 220 VAC 7 A 24 VDC	3.5 A 220 VAC 3.5 A 24 VDC
Contact material	Ag		Ag (Au Flash)		AgCdO	
Carry current	5 A	3 A	1 A	3 A	7 A	
Max. operating voltage	250 VAC 125 VDC					
Max. operating current	5 A		1 A	3 A	7 A	
Max. switching capacity	1,100 VA 120 W	440 VA 48 W	660 VA 72 W	176 VA 36 W	1,540 VA 168 W	770 VA 84 W
Min. permissible load (see note)	Standard type: 1 mA, 5 VDC Bifurcated type: 100 μA, 1 VDC		Standard and high sensitivity types: 1 mA, 1 VDC		100 μA, 1 VDC	

Non-latching – Sealed/Hermetically sealed

Load	Sealed, 4PDT		Hermetically sealed, 4DPT	
	Resistive load (p.f. = 1)	Inductive load (p.f. = 0.4) (L/R = 7 ms)	Resistive load (p.f. = 1)	Inductive load (p.f. = 0.4) (L/R = 7 ms)
Rated load	1 A at 220 VAC 1 A at 24 VDC	0.5 A at 220 VAC 0.5 A at 24 VDC	3 A at 110 VAC 3 A at 24 VDC	0.8 A at 110 VAC 1.5 A at 24 VDC
Contact material	Ag (Au Flash)			
Carry current	1 A		3 A	
Max. operating voltage	250 VAC 125 VDC		125 VAC 125 VDC	
Max. operating current	1 A		3 A	
Max. switching capacity	220 VA 24 W	110 VA 12 W	330 VA 72 W	88 VA 36 W
Min. permissible load (see note)	Standard and high sensitivity types: 1 mA, 1 VDC Bifurcated type: 100 μA, 1 VDC			

Note: P level: $\lambda_{60} = 0.1 \times 10^{-6}/\text{operation}$

■ COIL DATA

Non-latching – AC

Rated voltage (V)	Rated current (mA)		Coil resistance (Ω)	Coil inductance (ref. value) (H)		Pick-up voltage (% of rated voltage)	Dropout voltage	Maximum voltage	Power consumption (VA, W)
	50 Hz	60 Hz		Armature OFF	Armature ON				
6	214.10	183	12.20	0.04	0.08	80% max.	30% min.	110% max.	Approx. 1.00 to 1.20
12	106.50	91	46	0.17	0.33				
24	53.80	46	180	0.69	1.30				
50	25.70	22	788	3.22	5.66				
100/110	11.70/12.90	10/11	3,750	14.54	24.60				Approx. 0.90 to 1.10
110/120	9.90/10.80	8.40/9.20	4,430	19.20	32.10				
200/220	6.20/6.80	5.30/5.80	12,950	54.75	94.07				
220/240	4.80/5.30	4.20/4.60	18,790	83.50	136.40				

Non-latching – DC

Rated voltage (V)	Rated current (mA)	Coil resistance (Ω)	Coil inductance (ref. value) (H)		Pick-up voltage (% of rated voltage)	Dropout voltage	Maximum voltage	Power consumption (VA, W)
			Armature OFF	Armature ON				
6	150	40	0.17	0.33	80% max.	10% min.	110% max.	Approx. 0.90
12	75	160	0.73	1.37				
24	36.90	650	3.20	5.72				
48	18.50	2,600	10.60	21.00				
100/110	9.10/10	11,000	45.60	86.20				

Latching – AC

Rated voltage (V)	Rated current (mA)			Coil resistance (Ω)		Pick-up voltage (% of rated voltage)	Dropout voltage	Maximum voltage	Power consumption (VA, W)	
	Set coil		Reset coil	Set coil	Reset coil				Set coil	Reset coil
	50 Hz	60 Hz	50/60 Hz							
6	146	142	68	13	32	80% max.	80% max.	110% max.	Approx. 0.60 to 0.90	Approx. 0.20 to 0.50
12	57	56	39	72	130					
24	27.40	26.40	18.60	320	550					
50	14	13.40	3.50	1,400	3,000					
120	15.80	5.60	3.50	8,300	3,000					

Latching – DC

Rated voltage (V)	Rated current (mA)		Coil resistance (Ω)		Pick-up voltage (% of rated voltage)	Dropout voltage	Maximum voltage	Power consumption (VA, W)	
	Set coil	Reset coil	Set coil	Reset coil				Set coil	Reset coil
	50/60 Hz	50/60 Hz							
6	230	100	26	60	80% max.	80% max.	110% max.	Approx. 1.30	Approx. 0.06
12	110	50	110	235					
24	52	25	470	940					

- Note:
1. The rated current and coil resistance are measured at a coil temperature of 23°C (73°F) with tolerances of +15%, -20% for AC rated current, and ±15% for DC rated coil resistance.
 2. The AC coil resistance and inductance are reference values at 60 Hz.
 3. The performance characteristics are measured at a coil temperature of 23°C (73°F).
 4. Because the coil is designed for low power consumption, connect a bleeder (if necessary after confirming the leakage current), when the coil is driven by an SCR.
 5. For AC type latching coils, the rated current values are half-wave rectified current values measured with a DC ammeter.

■ CHARACTERISTICS

Non-latching

Contact resistance		50 mΩ max.
Operate time		20 ms max.
Release time		20 ms max.
Operating frequency	Mechanically	18,000 operations/hour
	Under rated load	1,800 operations/hour
Insulation resistance		100 MΩ min. (at 500 VDC)
Dielectric strength	Single contact type	Unsealed: 2,000 VAC, 50/60 Hz for 1 minute 1,000 VAC, 50/60 Hz for 1 minute between contacts of same polarity Sealed: 1,500 VAC, 50/60 Hz for 1 minute 1,000 VAC, 50/60 Hz for 1 minute between contacts of same polarity Hermetically sealed: 1,000 VAC, 50/60 Hz for 1 minute 700 VAC, 50/60 Hz for 1 minute between contacts of same polarity
	Bifurcated contact type	1,500 VAC, 50/60 Hz for 1 minute 1,000 VAC, 50/60 Hz for 1 minute between non-continuous contacts
Vibration	Mechanical durability	10 to 55 Hz, 1.00 mm (0.04 in) double amplitude
	Malfunction durability	10 to 55 Hz, 1.00 mm (0.04 in) double amplitude
Shock	Mechanical durability	1,000 m/s ² (approx. 100 G)
	Malfunction durability	200 m/s ² (approx. 20 G)
Ambient temperature	Operating	Unsealed: -55° to 70°C (-67° to 158°F) Sealed: -55° to 60°C (-67° to 140°F) Hermetically sealed: 25° to 60°C (77° to 140°F)
Humidity		35% to 85% RH
Service Life	Mechanically	Single contact type: AC: 50 million operations min. (at operating frequency of 18,000 operations/hour) DC: 100 million operations min. (at operating frequency of 18,000 operations/hour)
	Mechanically	Bifurcated contact type: AC: 50 million operations min. DC: 20 million operations min. (5 million operations for the sealed/hermetically sealed types) (at operating frequency of 1,800 operations/hour)
	Electrically	See "Characteristic Data"
Weight		Sealed/unsealed: Approx. 35 g (1.23 oz) Hermetically sealed: Approx. 50 g (1.76 oz)

Latching

Contact resistance		50 mΩ max.
Operate time		AC: 30 ms max.; DC: 15 ms max.
Release time		AC: 30 ms max.; DC: 15 ms max.
Operating frequency	Mechanically	18,000 operations/hour
	Under rated load	1,800 operations/hour
Insulation resistance		100 MΩ min. (at 500 VDC)
Dielectric strength		1,500 VAC, 50/60 Hz for 1 minute 1,000 VAC, 50/60 Hz for 1 minute between contacts of same polarity, and between set and reset coils
Vibration	Mechanical durability	10 to 55 Hz, 1.00 mm (0.04 in) double amplitude
	Malfunction durability	10 to 55 Hz, 1.00 mm (0.04 in) double amplitude
Shock	Mechanical durability	1,000 m/s ² (approx. 100 G)
	Malfunction durability	200 m/s ² (approx. 20 G)
Ambient temperature	Operating	-55° to 70°C (-67° to 158°F)
Humidity		45% to 85% RH
Service Life	Mechanically	100 million operations min. (at operating frequency of 18,000 operations/hour)
	Electrically	See "Characteristic Data"
Weight		Approx. 30 g (1.06 oz)

Note: Data shown are of initial value.

CHARACTERISTIC DATA

Maximum switching capacity – Non-latching

MY2, MY3



MY4

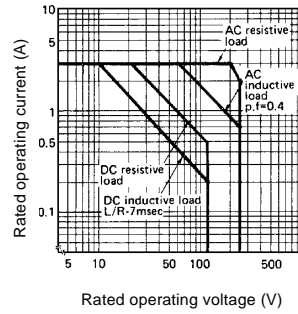

MY4(Z)H



MYQ4(Z)H



Electrical service life

MY2, MY3 (Resistive load)

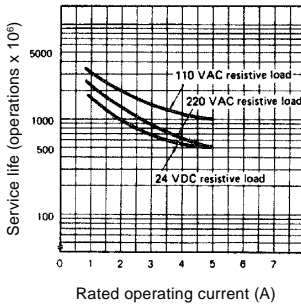

MY2, MY3 (Inductive load)

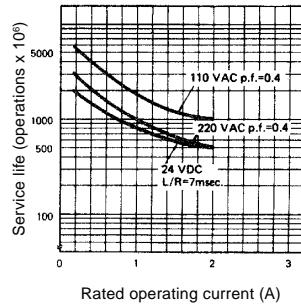

MY4 (Resistive load)

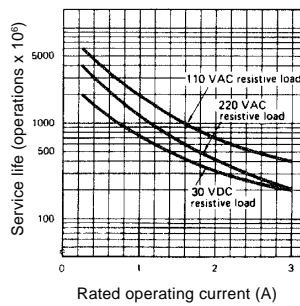

MY4 (Inductive load)

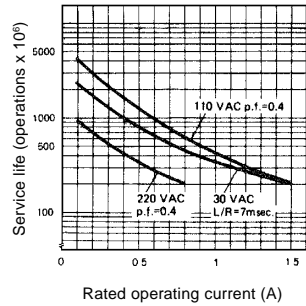

MY4H

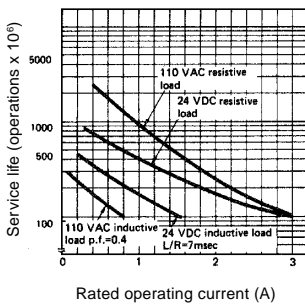

MY4Z (Resistive load)

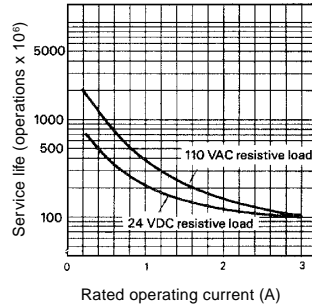

MY4Z (Inductive load)

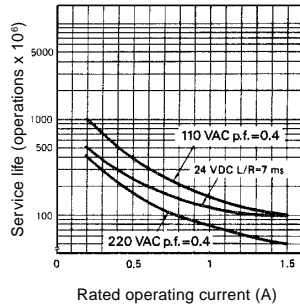

MYQ4

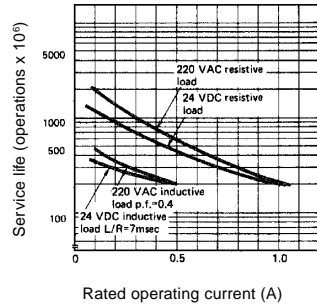

MY2-Y (Resistive load)

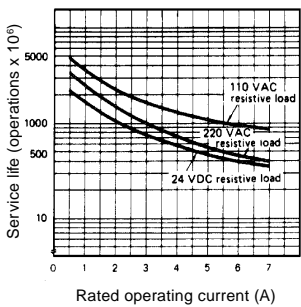

MY2-Y (Inductive load)

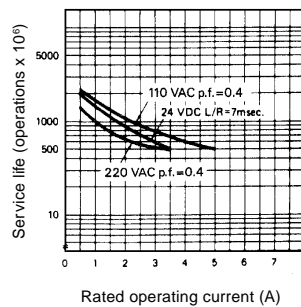

Maximum switching capacity – Latching

MY2K(-02)-US

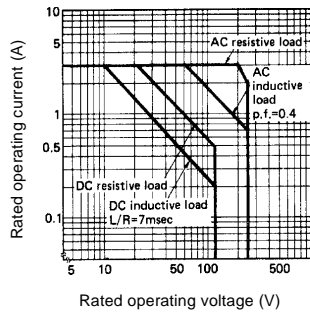

Electrical service life

MY2K(-02)-US

(Resistive load)

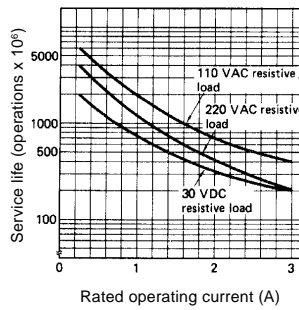

(Inductive load)

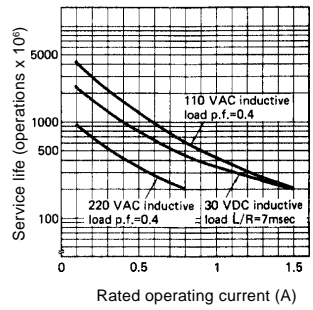

Dimensions

Unit: mm (inch)

RELAYS

MY2

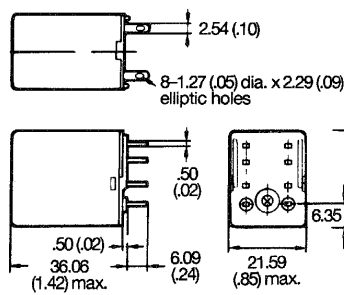

MY3

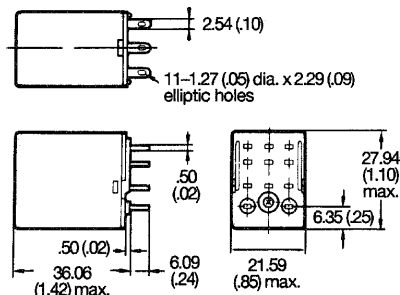

MY4

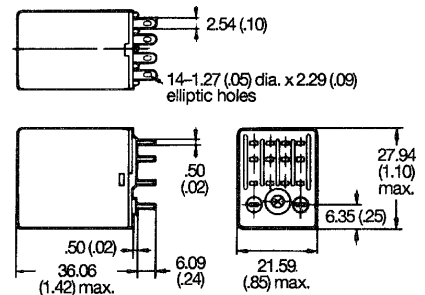

MY□-02

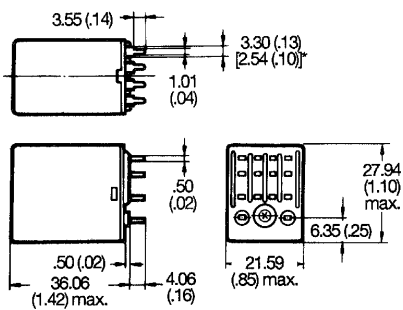

Mounting holes

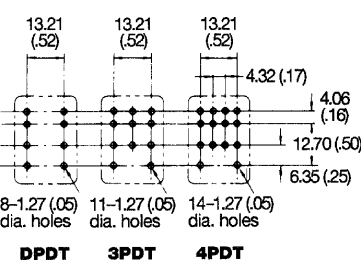

MY□F

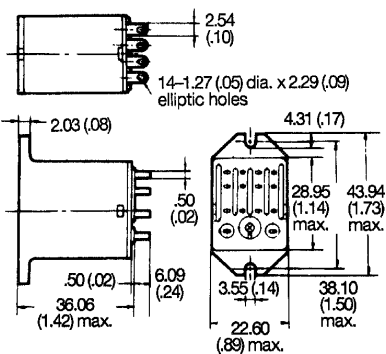

Mounting holes

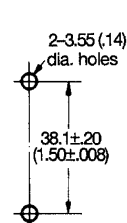

Note: The above dimensioned drawing shows the 4-pole type. The dimensions of the 2- and 3-pole types are identical to the 4-pole type.

Unit: mm (inch)

■ RELAYS (continued)

MY(Z)H

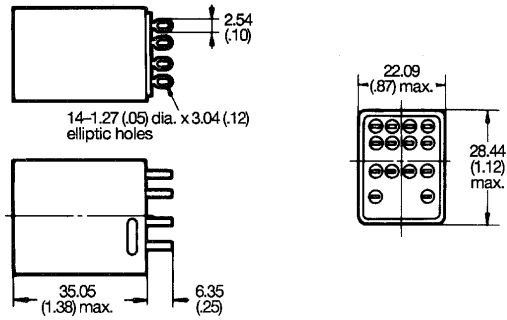

MY4(Z)H-0

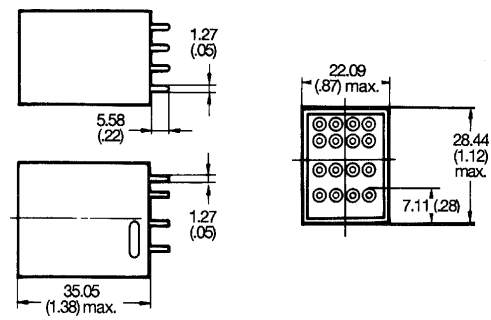

MY□-5

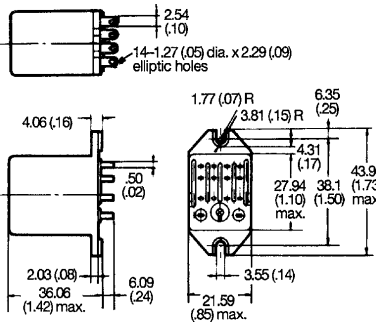

Mounting holes

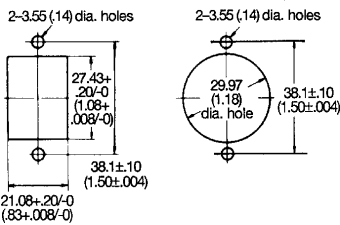

Terminal arrangement

(Bottom view)

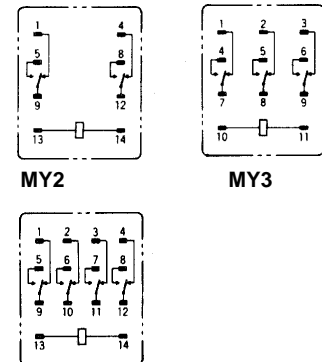

MY4, MYQ4(Z), MY4(Z)H, MY4H-0

Note: The above dimensioned drawing shows the 4-pole type. The dimensions of the 2- and 3-pole types are identical to the 4-pole type.

MYQ4(Z)

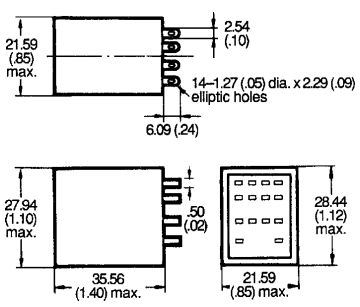

MYQ4(Z)-02

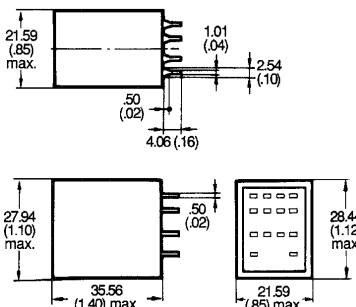

MY2K-US

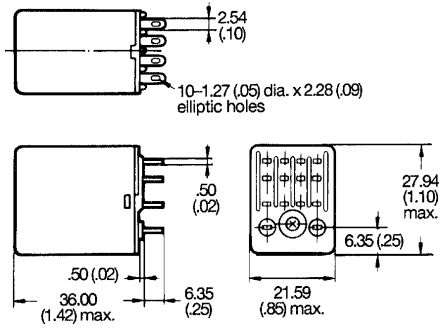

MY2K-02-US

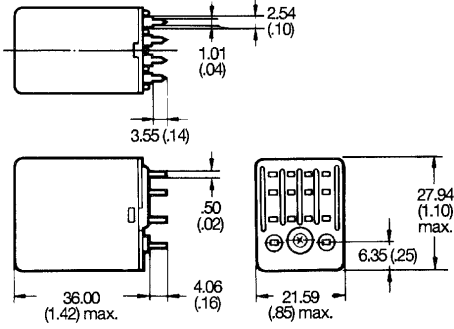

Mounting holes

(Bottom view)

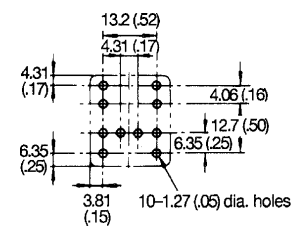

Unit: mm (inch)

■ ACCESSORIES

Track mounted sockets (UL File No. E87929) (CSA Report No. LR46088)

PYF08A-E

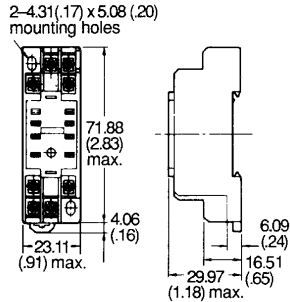

Terminal arrangement/
mounting holes
(Top view)

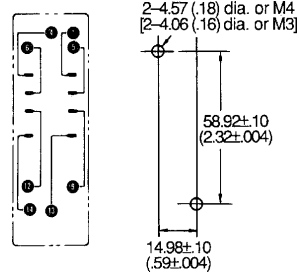

PYF11A

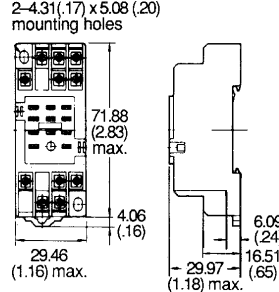

Terminal arrangement/
mounting holes
(Top view)

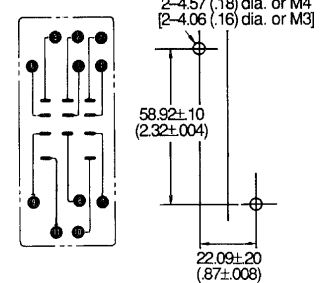

PYF14A-E

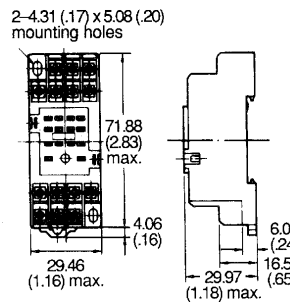

Terminal arrangement/
mounting holes
(Top view)

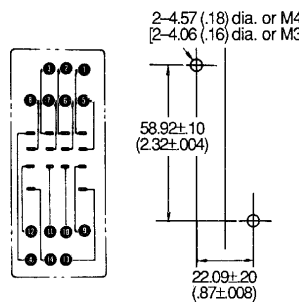

Mounting height of
relay with socket

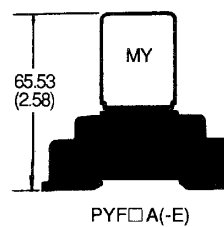

Back connecting socket (UL File No. E87929) (CSA Report No. LR46088) – DPDT

PY08

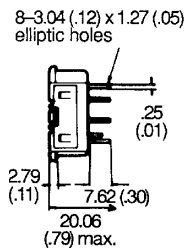

PY08QN

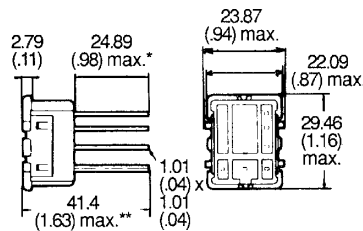

PY08-02

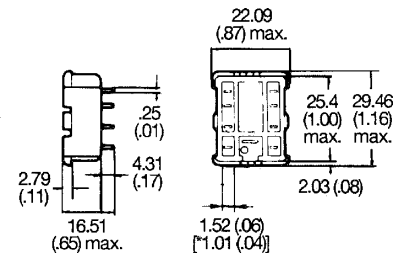

Back connecting socket (UL File No. E87929) (CSA Report No. LR46088) – 3PDT

PY11

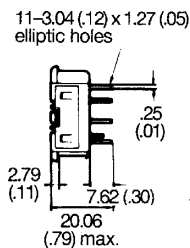

PY11QN

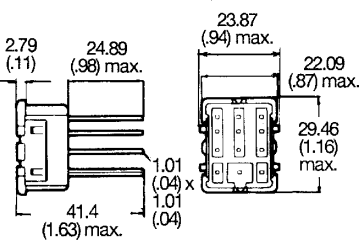

PY11-02

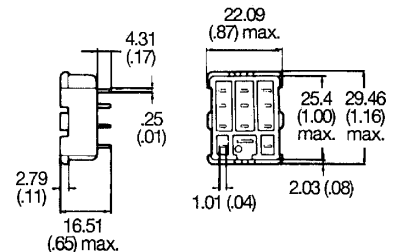

Note: 1. UL/CSA does not apply to wire wrap (Q) type sockets.
2. Value in brackets is for MY□CR.

Unit: mm (inch)

■ ACCESSORIES (continued)

Back connecting socket (UL File No. E87929) (CSA Report No. LR46088) – 4PDT

PY14

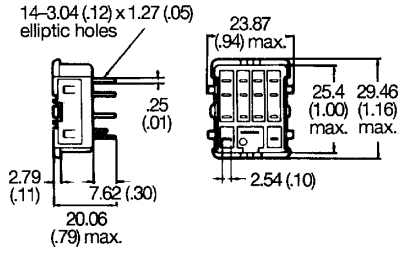

PY14QN

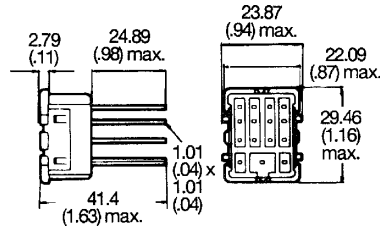

PY14-02

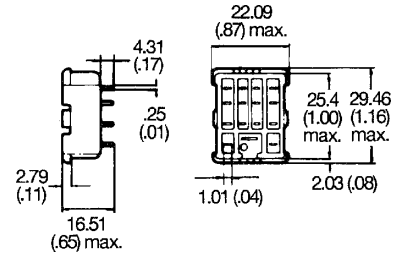

Terminal arrangement (Bottom view)

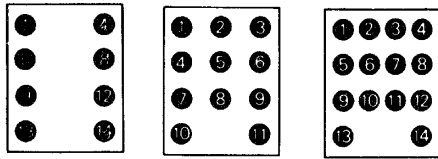

DPDT

3DPT

4DPT

Panel cutout

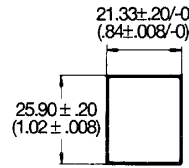

Mounting height of relay with socket

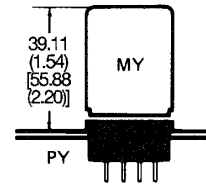

Note: Value in brackets is for MY□-CR.

Mounting holes

DPDT

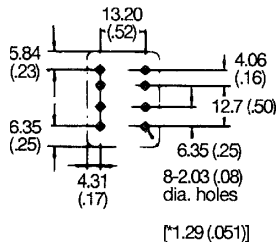

3PDT

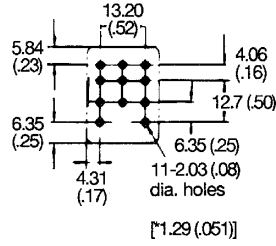

4PDT

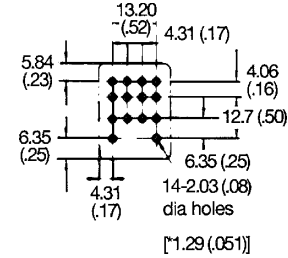

* For types with suffix - 02.

Relay hold-down clip

PYC-A1

for PYF□A socket

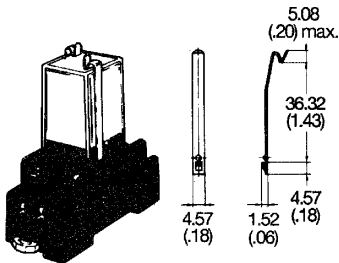

PYC-P

for PY□ socket

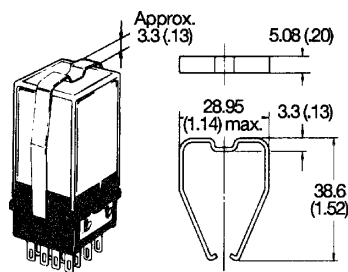

PYC-S

for relay mounting plates

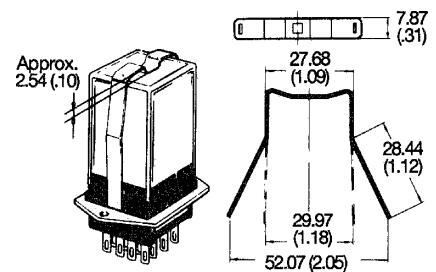

Relay hold-down clip

PYC-P2

for test button self-contained type with PY□A socket



Y92-HC

for RC circuit

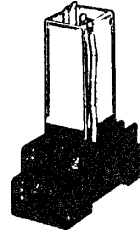

PYC-1

for RC circuit



PFP-100N/PFP-50N mounting track

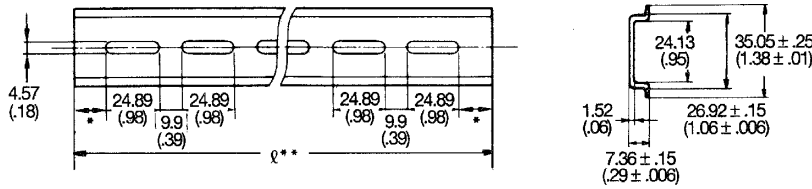

PFP-100N2 mounting track

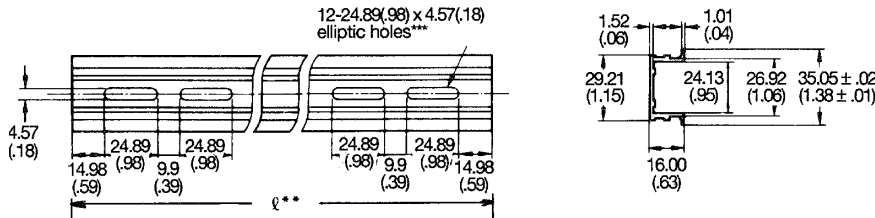

* This dimension is 14.99 mm (0.59 in) on both ends in the case of PFP-100N, but on one end in the case of PFP-50N.

** L = Length

PFP-50N L = 497.84 mm (19.60 in)

PFP-100N L = 990.60 mm (39.00 in)

PFP-100N2 L = 990.60 mm (39.00 in)

*** A total of twelve 24.89 x 4.57 mm (0.98 x 0.18 in) elliptical holes are provided, with six holes cut from each end of the track at a pitch of 9.91 (0.39) between holes.

PFP-M end plate

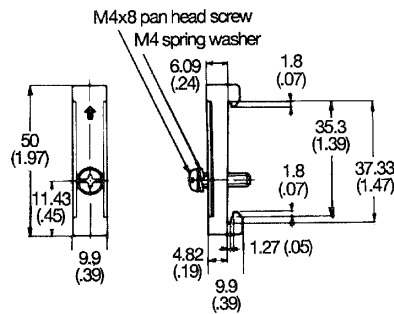

PFP-S spacer

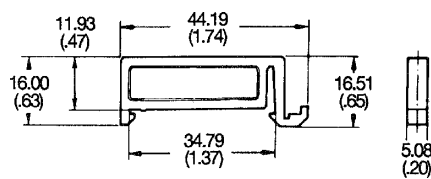

Unit: mm (inch)

■ **ACCESSORIES (continued)**

Socket mounting plates [t=1.52 (.06)]

PYP-1

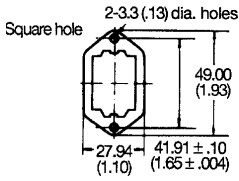

PYP-18



PYP-36

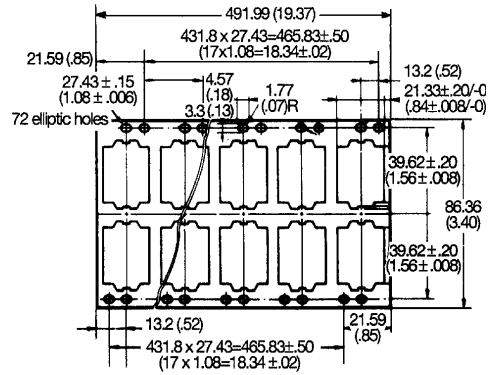

	Number of socket specs.		
Socket needed	1	18	36
PY08, PY11, PY11QN, PY14, PY4QN	PYP-1	PYP-18	PYP-36

■ **RELAY OPTIONS**

LED Indicator

Specifications and dimensions same as the standard type with the following exception. Because an LED indicator is employed as the operation indicator, the rated current is approximately 3.8 mA higher in the DC types and 0.5 to 5 mA higher in the AC types than in the standard type.

Ambient operating temperature: -55° to 60°C (-67° to 140°F).

Green LED DC
Red LED AC

Terminal arrangement/Internal connections (Bottom view)

MY4N

DC coil rating type

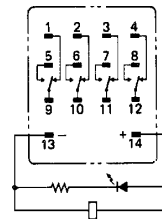

AC coil rating type

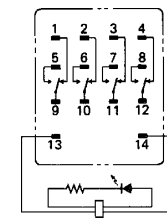

- Note:
1. In MY2N and MY3N, only the contact circuit is different from the illustration below. The coil terminals 10 and 11 of MY3N become (-) and (+), respectively.
 2. Pay special attention to the polarities when using the DC type.
 3. The AC coil-type is provided with a self-diagnostic function that detects a breakage in the coil.

RC Circuit

Specifications and dimensions same as the standard type with the following exceptions.

The panel cutout dimensions are the same as those of the standard type. However, the height is higher by 17.02 mm (0.67 in).

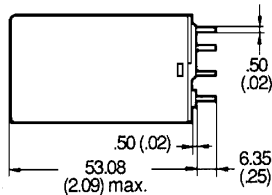
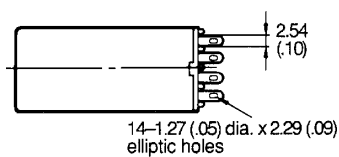

Terminal arrangement/Internal connections (Bottom view)

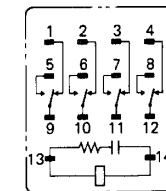

RC circuit
C : 0.033 μF
R : 120 Ω

- Note:
1. The above dimensioned drawing shows the 4-pole type. The dimensions of the 2- and 3-pole types are identical to the 4-pole type.
 2. Available on AC versions only.
 3. Terminal arrangement/internal connections: MY2-Y is the same as the standard type; MY2N-Y is the same as the LED indicator type.

Characteristic Data

Without RC circuit

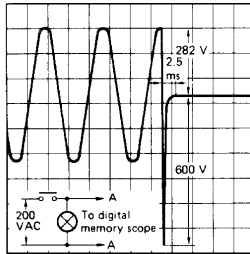

With RC circuit



Push-to-test button

MY□12

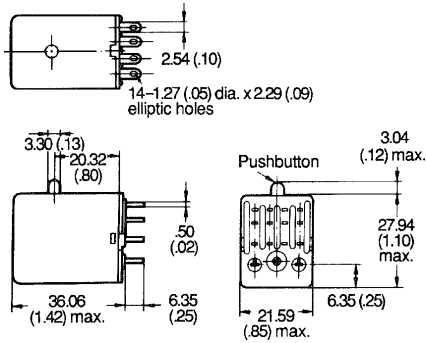

Mounting holes

When mounting the relay, use the connecting socket PYC-P2 shown in "ACCESSORIES" section. The mounting hole dimensions shown here are applicable to the relay with mounting stud.

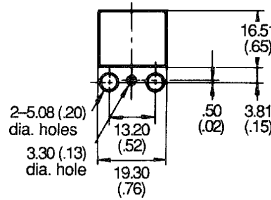

Note: The dimension drawings show the 4-pole type. The dimensions of the 2- and 3-pole types are identical to the 4-pole type.

Diode Surge Suppression

Specifications and dimensions same as the standard type with the following exceptions.

Terminal arrangement/internal connections: MY2(N)-D(2) is the same as the MY4(N)-D(2) with the exception of the contact configuration.

Ambient operating temperature: -55° to 60°C (-67° to 140°F).

Terminal arrangement/Internal connections (Bottom view)

MY4-D
6, 12, 24, 48
100/110 VDC



MY4N-D2
6, 12, 24, 48 VDC

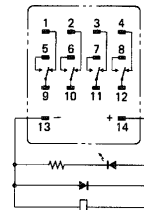

MY4N-D2
100/110 VDC



- Note:
1. Pay special attention to the polarities when using the DC type.
 2. The release time is somewhat longer, but satisfies the standard specifications of 25 ms.
 3. The reverse-breakdown voltage of the diode is 1,000 VDC.
 4. Available on DC versions only.

Connecting sockets

Use the standard MY4 (4PDT) sockets with the terminal arrangements listed below.

Terminal arrangement/Internal connections (Bottom view)

AC

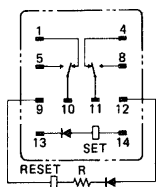

DC

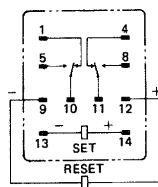

- Note:
1. R is a resistor for ampere-turn compensation, and is incorporated in the relays rated at 50 VAC or above.
 2. Pay attention to the polarity of the set and reset coils, as incorrect connection of positive and negative terminals will result in malfunctioning of the relay.

■ APPROVALS

UL recognized type (File No. E41515)

Type	Contact form	Coil ratings	Contact ratings
MY□	DPDT	6 to 240 VAC 6 to 120 VDC	5 A, 120 VAC (Resistive)
			5 A, 28 VDC (Resistive)
	3PDT		5 A, 240 VAC (Inductive)
			5 A, 28 VDC (Resistive)
	4PDT		5 A, 240 VAC (Resistive)
			3 A, 28 VDC (Resistive)
			3 A, 120 VAC (Inductive)
			1.5 A, 240 VAC (Inductive)
			5 A, 240 VAC (Inductive, same polarity)
			5 A, 28 VDC (Resistive, same polarity)
MY2K-□	DPDT	5 to 120 VAC 5 to 48 VDC	3 A, 240 VAC (Resistive) 3 A, 28 VDC (Resistive)

CSA certified type (File No. LR31928)

Type	Contact form	Coil ratings	Contact ratings
MY□	DPDT	6 to 240 VAC 6 to 120 VDC	5 A, 28 VDC (Resistive)
			5 A, 240 VAC (Inductive)
	3PDT		3 A, 28 VDC (Resistive)
			3 A, 240 VAC (Inductive)
			5 A, 240 VAC (Inductive, same polarity)
			5 A, 28 VDC (Resistive, same polarity)
MY2K-□	DPDT	5 to 120 VAC 5 to 48 VDC	3 A, 240 VAC (General purpose) 3 A, 30 VDC (Resistive)

LR (Lloyd's Register) approved type (File No. 563KOB-204524)

Type	Contact form	Coil ratings	Contact ratings
MY□	DPDT	6 to 240 VAC 6 to 120 VDC	2 A, 30 VDC (Inductive)
	4PDT		2 A, 200 VAC (Inductive)
			1.5 A, 30 VDC (Inductive)
			0.8 A, 200 VAC (Inductive)
			1.5 A, 115 VAC (Inductive)

SEV listed type (File No. D791/63 [2- & 4-pole], D791/91 [3-pole])

Type	Contact form	Coil ratings	Contact ratings
MY□-SV	DPDT	6 to 240 VAC	5 A, 220 VAC (Resistive)
	3PDT	6 to 110 VDC	5 A, 24 VDC (Resistive)
	4PDT		

- Note: 1. The rated values approved by each of the safety standards (e.g., UL, CSA, VDE, and SEV) may be different from the performance characteristics individually defined in this catalog.
 2. In the interest of product improvement, specifications are subject to change.

■ HINTS ON CORRECT USE

When using the relay rated at 120 VAC at a supply voltage of 240 VAC, be sure to connect external resistors Rs and Rr to the relay.

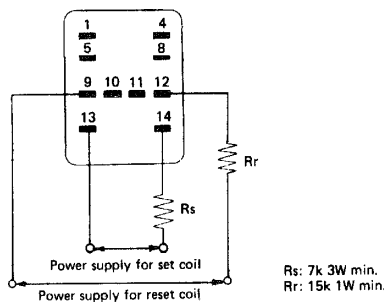



OMRON ELECTRONICS, INC.

One East Commerce Drive
Schaumburg, IL 60173
1-800-55-OMRON

OMRON CANADA, INC.

885 Milner Avenue
Scarborough, Ontario M1B 5V8
416-286-6465



Компания «ЭлектроПласт» предлагает заключение долгосрочных отношений при поставках импортных электронных компонентов на взаимовыгодных условиях!

Наши преимущества:

- Оперативные поставки широкого спектра электронных компонентов отечественного и импортного производства напрямую от производителей и с крупнейших мировых складов;
- Поставка более 17-ти миллионов наименований электронных компонентов;
- Поставка сложных, дефицитных, либо снятых с производства позиций;
- Оперативные сроки поставки под заказ (от 5 рабочих дней);
- Экспресс доставка в любую точку России;
- Техническая поддержка проекта, помощь в подборе аналогов, поставка прототипов;
- Система менеджмента качества сертифицирована по Международному стандарту ISO 9001;
- Лицензия ФСБ на осуществление работ с использованием сведений, составляющих государственную тайну;
- Поставка специализированных компонентов (Xilinx, Altera, Analog Devices, Intersil, Interpoint, Microsemi, Aeroflex, Peregrine, Syfer, Eurofarad, Texas Instrument, Miteq, Cobham, E2V, MA-COM, Hittite, Mini-Circuits, General Dynamics и др.);

Помимо этого, одним из направлений компании «ЭлектроПласт» является направление «Источники питания». Мы предлагаем Вам помощь Конструкторского отдела:

- Подбор оптимального решения, техническое обоснование при выборе компонента;
- Подбор аналогов;
- Консультации по применению компонента;
- Поставка образцов и прототипов;
- Техническая поддержка проекта;
- Защита от снятия компонента с производства.



Как с нами связаться

Телефон: 8 (812) 309 58 32 (многоканальный)

Факс: 8 (812) 320-02-42

Электронная почта: org@eplast1.ru

Адрес: 198099, г. Санкт-Петербург, ул. Калинина, дом 2, корпус 4, литера А.