

## 50 mA, 100 mA and 150 mA CMOS LDOs with Shutdown and Reference Bypass

- Low Supply Current (50  $\mu$ A, typical)
- Low Dropout Voltage
- Choice of 50 mA (TC1014), 100 mA (TC1015) and 150 mA (TC1185) Output
- High Output Voltage Accuracy
- Standard or Custom Output Voltages
- Power-Saving Shutdown Mode
- Reference Bypass Input for Ultra Low-Noise Operation
- Overcurrent and Overtemperature Protection
- Space-Saving 5-Pin SOT-23 Package
- Pin-Compatible Upgrades for Bipolar Regulators
- Standard Output Voltage Options:
  - 1.8V, 2.5V, 2.6V, 2.7V, 2.8V, 2.85V, 3.0V, 3.3V, 3.6V, 4.0V, 5.0V

### Applications:

- Battery-Operated Systems
- Portable Computers
- Medical Instruments
- Instrumentation
- Cellular/GSM/PHS Phones
- Linear Post-Regulator for SMPS
- Pagers

### Typical Application



The TC1014/TC1015/TC1185 are high accuracy (typically  $\pm 0.5\%$ ) CMOS upgrades for older (bipolar) Low Dropout Regulators (LDOs) such as the LP2980. Designed specifically for battery-operated systems, the devices' CMOS construction eliminates wasted ground current, significantly extending battery life. Total supply current is typically 50  $\mu$ A at full load (20 to 60 times lower than in bipolar regulators).

The devices' key features include ultra low-noise operation (plus optional Bypass input), fast response to step changes in load, and very low dropout voltage, typically 85 mV (TC1014), 180 mV (TC1015), and 270 mV (TC1185) at full-load. Supply current is reduced to 0.5  $\mu$ A (max) and  $V_{OUT}$  falls to zero when the shutdown input is low. The devices incorporate both overtemperature and overcurrent protection.

The TC1014/TC1015/TC1185 are stable with an output capacitor of only 1  $\mu$ F and have a maximum output current of 50 mA, 100 mA and 150 mA, respectively. For higher output current regulators, please see the TC1107 (DS21356), TC1108 (DS21357), TC1173 (DS21362) ( $I_{OUT} = 300$  mA) data sheets.

### Package Type



# TC1014/TC1015/TC1185

## 1.0 ELECTRICAL CHARACTERISTICS

### Absolute Maximum Ratings†

Input Voltage .....	6.5V
Output Voltage.....	(-0.3V) to (V <sub>IN</sub> + 0.3V)
Power Dissipation.....	Internally Limited ( <b>Note 7</b> )
Maximum Voltage on Any Pin .....	V <sub>IN</sub> + 0.3V to -0.3V
Operating Temperature Range.....	-40°C < T <sub>J</sub> < 125°C
Storage Temperature.....	-65°C to +150°C

† **Notice:** Stresses above those listed under "Absolute Maximum Ratings" may cause permanent damage to the device. These are stress ratings only and functional operation of the device at these or any other conditions above those indicated in the operation sections of the specifications is not implied. Exposure to Absolute Maximum Rating conditions for extended periods may affect device reliability.

### TC1014/TC1015/TC1185 ELECTRICAL SPECIFICATIONS

Electrical Specifications: V <sub>IN</sub> = V <sub>R</sub> + 1V, I <sub>L</sub> = 100 μA, C <sub>L</sub> = 1.0 μF, SHDN > V <sub>IH</sub> , T <sub>A</sub> = +25°C, unless otherwise noted. Boldface type specifications apply for junction temperatures of -40°C to +125°C.							
Parameter	Symbol	Min	Typ	Max	Units	Device	Test Conditions
Input Operating Voltage	V <sub>IN</sub>	<b>2.7</b>	—	<b>6.0</b>	V	—	<b>Note 1</b>
Maximum Output Current	I <sub>OUTMAX</sub>	<b>50</b> <b>100</b> <b>150</b>	—	—	mA	TC1014 TC1015 TC1185	
Output Voltage	V <sub>OUT</sub>	<b>V<sub>R</sub> - 2.5%</b>	V <sub>R</sub> ±0.5%	<b>V<sub>R</sub> + 2.5%</b>	V	—	<b>Note 2</b>
V <sub>OUT</sub> Temperature Coefficient	TCV <sub>OUT</sub>	—	20 <b>40</b>	—	ppm/°C	—	<b>Note 3</b>
Line Regulation	ΔV <sub>OUT</sub> /ΔV <sub>IN</sub>	—	0.05	<b>0c.35</b>	%	—	(V <sub>R</sub> + 1V) ≤ V <sub>IN</sub> ≤ 6V
Load Regulation	ΔV <sub>OUT</sub> /V <sub>OUT</sub>	—	0.5 0.5	<b>2</b> <b>3</b>	%	TC1014; TC1015 TC1185	I <sub>L</sub> = 0.1 mA to I <sub>OUTMAX</sub> I <sub>L</sub> = 0.1 mA to I <sub>OUTMAX</sub> <b>(Note 4)</b>
Dropout Voltage	V <sub>IN</sub> -V <sub>OUT</sub>	—	2 65 85 180 270	— — <b>120</b> <b>250</b> <b>400</b>	mV	— — — TC1015; TC1185 TC1185	I <sub>L</sub> = 100 μA I <sub>L</sub> = 20 mA I <sub>L</sub> = 50 mA I <sub>L</sub> = 100 mA I <sub>L</sub> = 150 mA <b>(Note 5)</b>
Supply Current ( <b>Note 8</b> )	I <sub>IN</sub>	—	50	<b>80</b>	μA	—	SHDN = V <sub>IH</sub> , I <sub>L</sub> = 0
Shutdown Supply Current	I <sub>INSD</sub>	—	0.05	0.5	μA	—	SHDN = 0V
Power Supply Rejection Ratio	PSRR	—	64	—	dB	—	F <sub>RE</sub> ≤ 1 kHz
Output Short Circuit Current	I <sub>OUTSC</sub>	—	300	450	mA	—	V <sub>OUT</sub> = 0V
Thermal Regulation	ΔV <sub>OUT</sub> /ΔP <sub>D</sub>	—	0.04	—	V/W	—	<b>Notes 6, 7</b>
Thermal Shutdown Die Temperature	T <sub>SD</sub>	—	160	—	°C	—	
Thermal Shutdown Hysteresis	ΔT <sub>SD</sub>	—	10	—	°C	—	

- Note 1:** The minimum V<sub>IN</sub> has to meet two conditions: V<sub>IN</sub> ≥ 2.7V and V<sub>IN</sub> ≥ V<sub>R</sub> + V<sub>DROPOUT</sub>.
- Note 2:** V<sub>R</sub> is the regulator output voltage setting. For example: V<sub>R</sub> = 1.8V, 2.5V, 2.6V, 2.7V, 2.8V, 2.85V, 3.0V, 3.3V, 3.6V, 4.0V, 5.0V.
- Note 3:**  $TC V_{OUT} = \frac{(V_{OUTMAX} - V_{OUTMIN}) \times 10^6}{V_{OUT} \times \Delta T}$
- Note 4:** Regulation is measured at a constant junction temperature using low duty cycle pulse testing. Load regulation is tested over a load range from 1.0 mA to the maximum specified output current. Changes in output voltage due to heating effects are covered by the thermal regulation specification.
- Note 5:** Dropout voltage is defined as the input to output differential at which the output voltage drops 2% below its nominal value at a 1V differential.
- Note 6:** Thermal Regulation is defined as the change in output voltage at a time T after a change in power dissipation is applied, excluding load or line regulation effects. Specifications are for a current pulse equal to I<sub>LMAX</sub> at V<sub>IN</sub> = 6V for T = 10 ms.
- Note 7:** The maximum allowable power dissipation is a function of ambient temperature, the maximum allowable junction temperature and the thermal resistance from junction-to-air (i.e., T<sub>A</sub>, T<sub>J</sub>, θ<sub>JA</sub>). Exceeding the maximum allowable power dissipation causes the device to initiate thermal shutdown. Please see **Section 5.0 "Thermal Considerations"** for more details.
- Note 8:** Apply for Junction Temperatures of -40°C to +85°C.

# TC1014/TC1015/TC1185

## TC1014/TC1015/TC1185 ELECTRICAL SPECIFICATIONS (CONTINUED)

<b>Electrical Specifications:</b> $V_{IN} = V_R + 1V$ , $I_L = 100 \mu A$ , $C_L = 1.0 \mu F$ , $SHDN > V_{IH}$ , $T_A = +25^\circ C$ , unless otherwise noted. Boldface type specifications apply for junction temperatures of $-40^\circ C$ to $+125^\circ C$ .							
Parameter	Symbol	Min	Typ	Max	Units	Device	Test Conditions
Output Noise	eN	—	600	—	nV/ $\sqrt{Hz}$	—	$I_L = I_{OUTMAX}$ , F = 10 kHz 470 pF from Bypass to GND
SHDN Input High Threshold	$V_{IH}$	45	—	—	% $V_{IN}$	—	$V_{IN} = 2.5V$ to $6.5V$
SHDN Input Low Threshold	$V_{IL}$	—	—	15	% $V_{IN}$	—	$V_{IN} = 2.5V$ to $6.5V$

- Note**
- 1: The minimum  $V_{IN}$  has to meet two conditions:  $V_{IN} \geq 2.7V$  and  $V_{IN} \geq V_R + V_{DROPOUT}$ .
  - 2:  $V_R$  is the regulator output voltage setting. For example:  $V_R = 1.8V, 2.5V, 2.6V, 2.7V, 2.8V, 2.85V, 3.0V, 3.3V, 3.6V, 4.0V, 5.0V$ .
  - 3:  $TC V_{OUT} = \frac{(V_{OUTMAX} - V_{OUTMIN}) \times 10^6}{V_{OUT} \times \Delta T}$
  - 4: Regulation is measured at a constant junction temperature using low duty cycle pulse testing. Load regulation is tested over a load range from 1.0 mA to the maximum specified output current. Changes in output voltage due to heating effects are covered by the thermal regulation specification.
  - 5: Dropout voltage is defined as the input to output differential at which the output voltage drops 2% below its nominal value at a 1V differential.
  - 6: Thermal Regulation is defined as the change in output voltage at a time T after a change in power dissipation is applied, excluding load or line regulation effects. Specifications are for a current pulse equal to  $I_{LMAX}$  at  $V_{IN} = 6V$  for T = 10 ms.
  - 7: The maximum allowable power dissipation is a function of ambient temperature, the maximum allowable junction temperature and the thermal resistance from junction-to-air (i.e.,  $T_A, T_J, \theta_{JA}$ ). Exceeding the maximum allowable power dissipation causes the device to initiate thermal shutdown. Please see **Section 5.0 "Thermal Considerations"** for more details.
  - 8: Apply for Junction Temperatures of  $-40^\circ C$  to  $+85^\circ C$ .

## TEMPERATURE CHARACTERISTICS

<b>Electrical Specifications:</b> $V_{IN} = V_R + 1V$ , $I_L = 100 \mu A$ , $C_L = 1.0 \mu F$ , $SHDN > V_{IH}$ , $T_A = +25^\circ C$ , unless otherwise noted. Boldface type specifications apply for junction temperatures of $-40^\circ C$ to $+125^\circ C$ .							
Parameters	Sym	Min	Typ	Max	Units	Conditions	
<b>Temperature Ranges:</b>							
Extended Temperature Range	$T_A$	-40	—	+125	$^\circ C$		
Operating Temperature Range	$T_A$	-40	—	+125	$^\circ C$		
Storage Temperature Range	$T_A$	-65	—	+150	$^\circ C$		
<b>Thermal Package Resistances:</b>							
Thermal Resistance, 5L-SOT-23	$\theta_{JA}$	—	256	—	$^\circ C/W$		

# TC1014/TC1015/TC1185

## 2.0 TYPICAL PERFORMANCE CURVES

**Note:** The graphs and tables provided following this note are a statistical summary based on a limited number of samples and are provided for informational purposes only. The performance characteristics listed herein are not tested or guaranteed. In some graphs or tables, the data presented may be outside the specified operating range (e.g., outside specified power supply range) and therefore outside the warranted range.

**Note:** Unless otherwise specified, all parts are measured at temperature = +25°C.

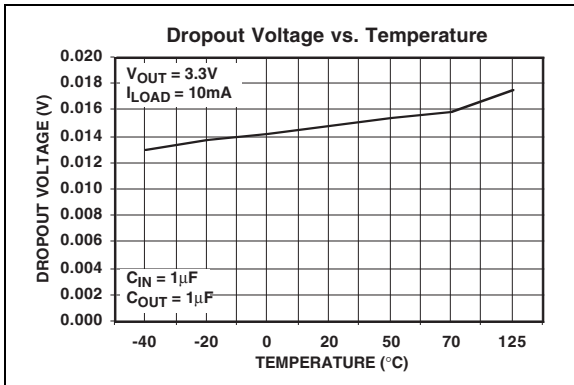

**FIGURE 2-1:** Dropout Voltage vs. Temperature.

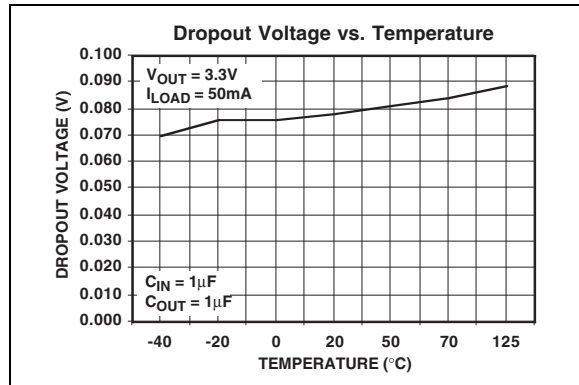

**FIGURE 2-4:** Dropout Voltage vs. Temperature.

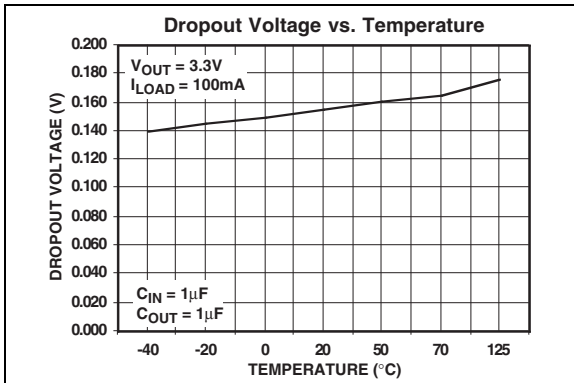

**FIGURE 2-2:** Dropout Voltage vs. Temperature.

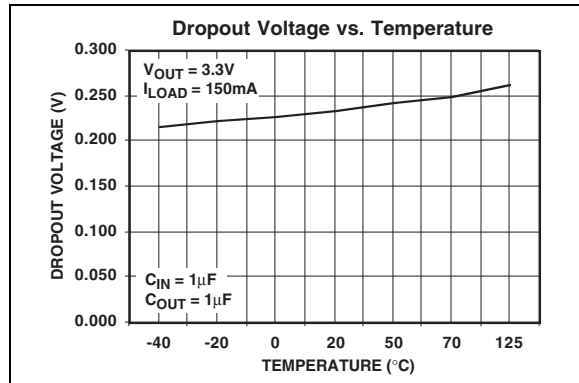

**FIGURE 2-5:** Dropout Voltage vs. Temperature.

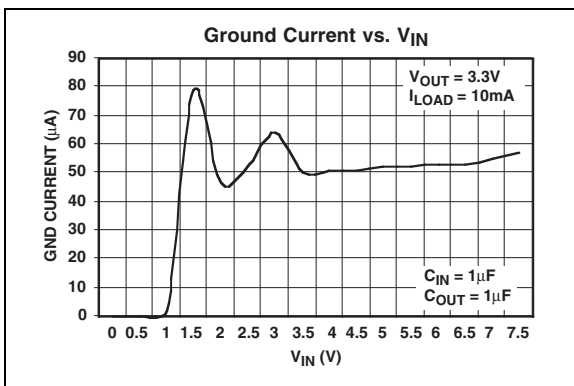

**FIGURE 2-3:** Ground Current vs. Input Voltage ( $V_{IN}$ ).

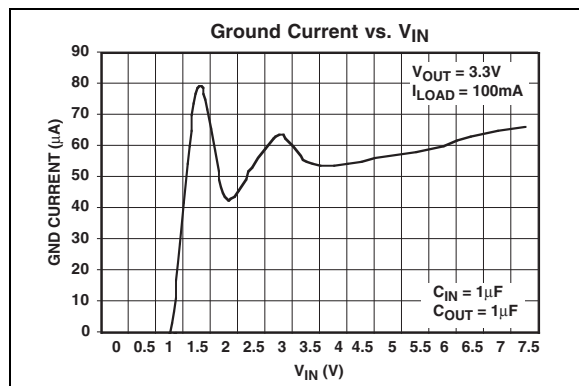

**FIGURE 2-6:** Ground Current vs. Input Voltage ( $V_{IN}$ ).

## TYPICAL PERFORMANCE CURVES (CONTINUED)

**Note:** Unless otherwise specified, all parts are measured at temperature = +25°C.

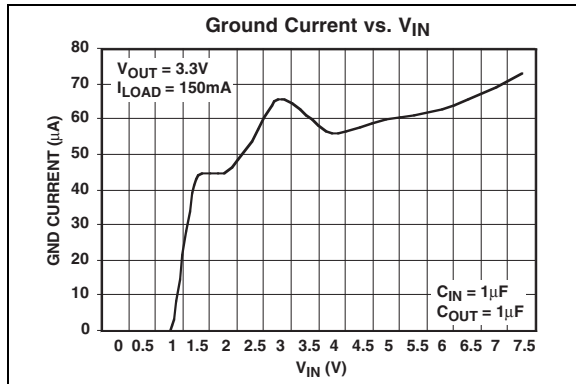

**FIGURE 2-7:** Ground Current vs. Input Voltage ( $V_{IN}$ ).



**FIGURE 2-10:** Output Voltage ( $V_{OUT}$ ) vs. Input Voltage ( $V_{IN}$ ).

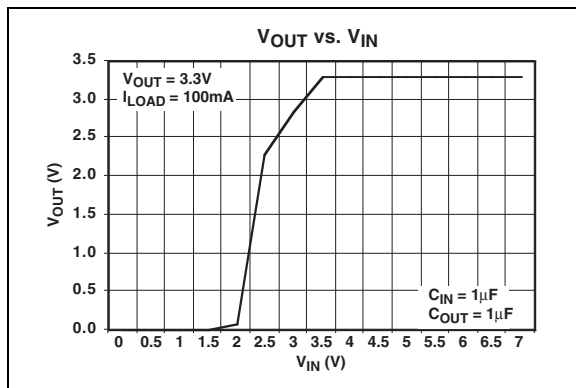

**FIGURE 2-8:** Output Voltage ( $V_{OUT}$ ) vs. Input Voltage ( $V_{IN}$ ).

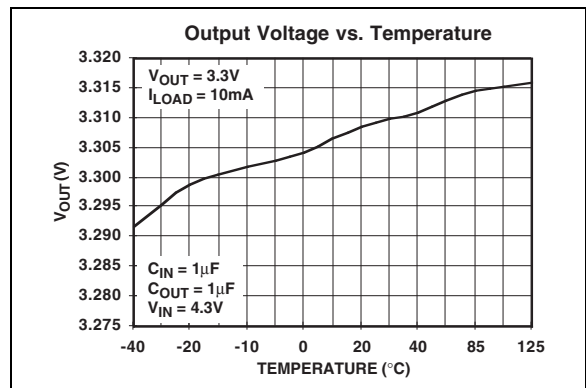

**FIGURE 2-11:** Output Voltage ( $V_{OUT}$ ) vs. Temperature.

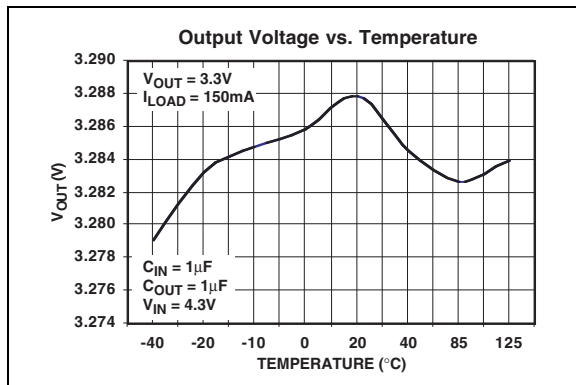

**FIGURE 2-9:** Output Voltage ( $V_{OUT}$ ) vs. Temperature.

# TC1014/TC1015/TC1185

## TYPICAL PERFORMANCE CURVES (CONTINUED)

Note: Unless otherwise specified, all parts are measured at temperature = +25°C.



FIGURE 2-12: Output Voltage ( $V_{OUT}$ ) vs. Temperature.

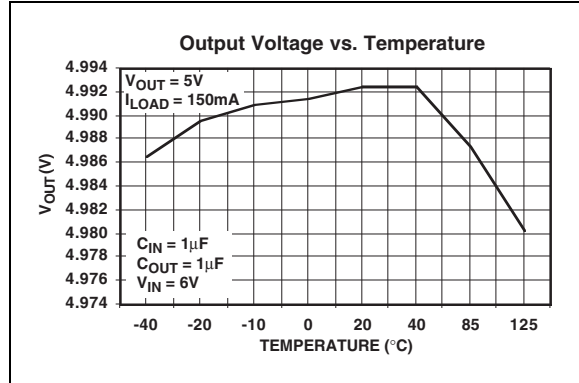

FIGURE 2-14: Output Voltage ( $V_{OUT}$ ) vs. Temperature.



FIGURE 2-13:  $I_{GND}$  vs. Temperature.

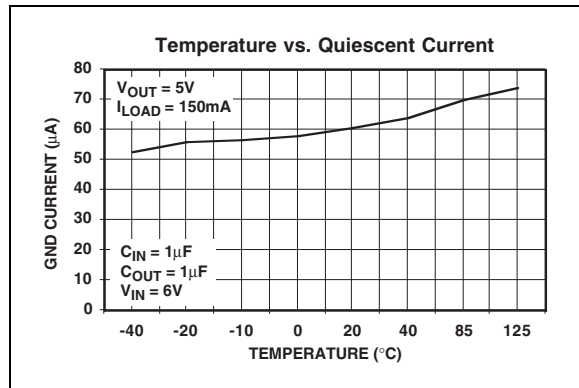

FIGURE 2-15:  $I_{GND}$  vs. Temperature.

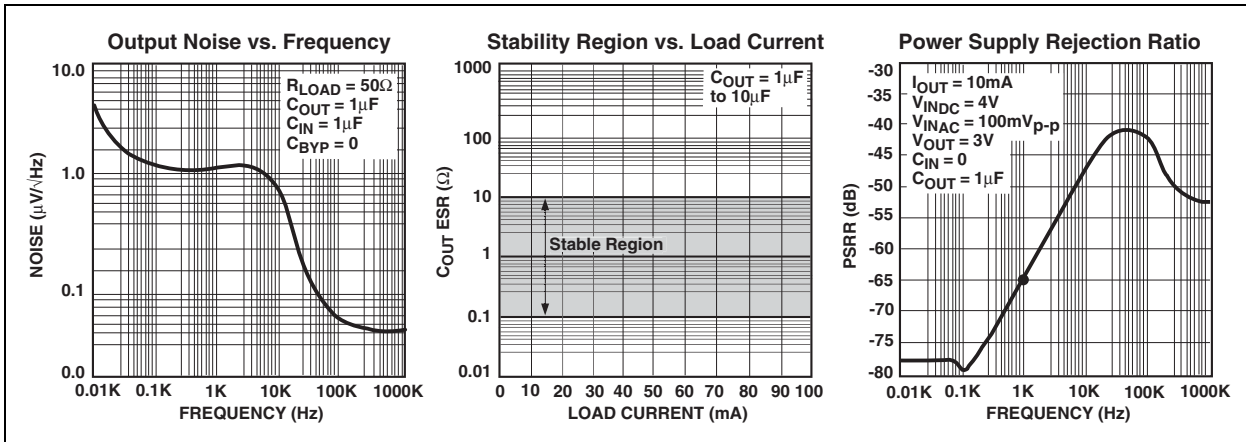
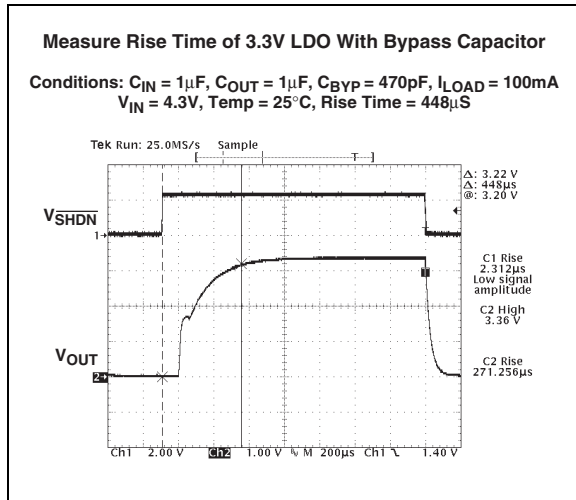

FIGURE 2-16: AC Characteristics.

## TYPICAL PERFORMANCE CURVES (CONTINUED)

**Note:** Unless otherwise specified, all parts are measured at temperature = +25°C.



**FIGURE 2-17:** Measure Rise Time of 3.3V with Bypass Capacitor.



**FIGURE 2-19:** Measure Rise Time of 3.3V without Bypass Capacitor.

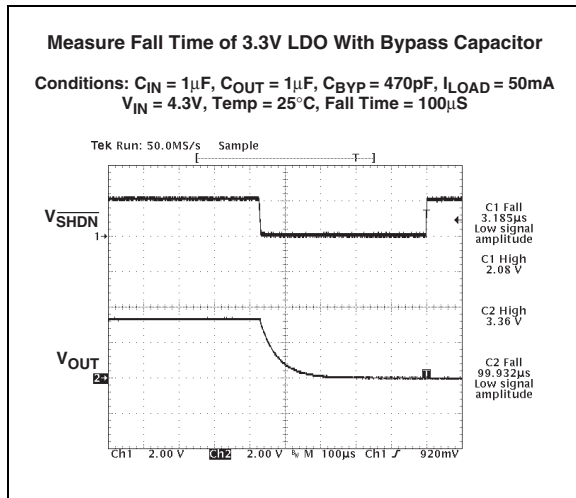

**FIGURE 2-18:** Measure Fall Time of 3.3V with Bypass Capacitor.

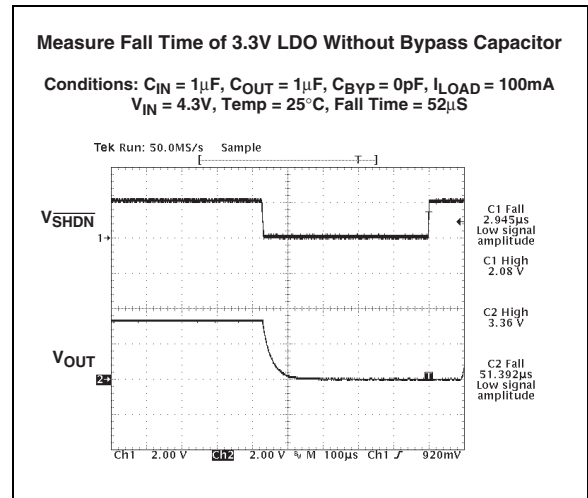
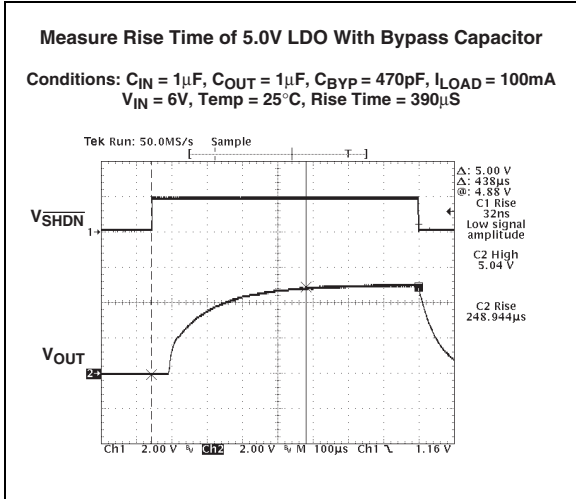

**FIGURE 2-20:** Measure Fall Time of 3.3V without Bypass Capacitor.

# TC1014/TC1015/TC1185

## TYPICAL PERFORMANCE CURVES (CONTINUED)

**Note:** Unless otherwise specified, all parts are measured at temperature = +25°C.



**FIGURE 2-21:** Measure Rise Time of 5.0V with Bypass Capacitor.

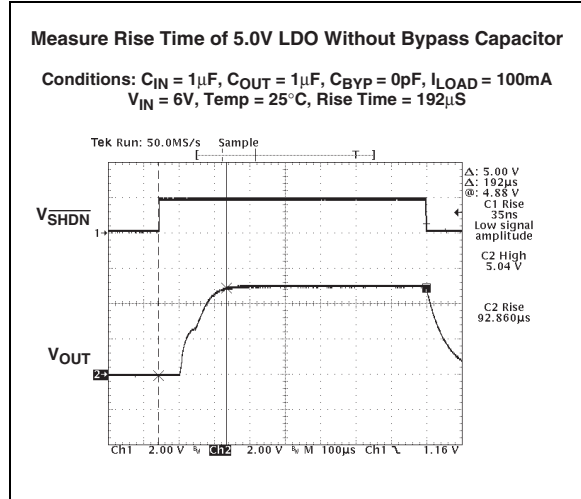

**FIGURE 2-23:** Measure Rise Time of 5.0V without Bypass Capacitor.

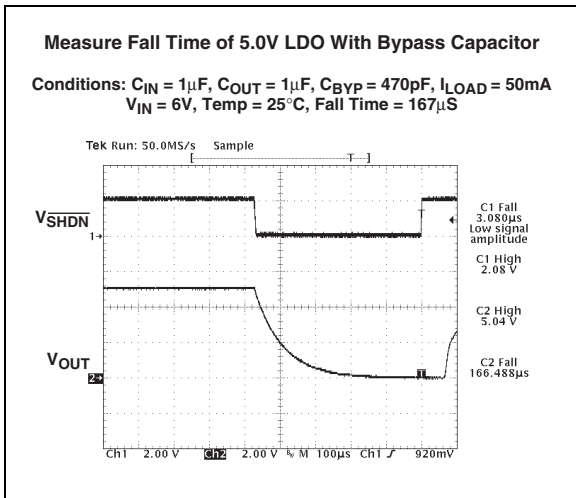

**FIGURE 2-22:** Measure Fall Time of 5.0V with Bypass Capacitor.

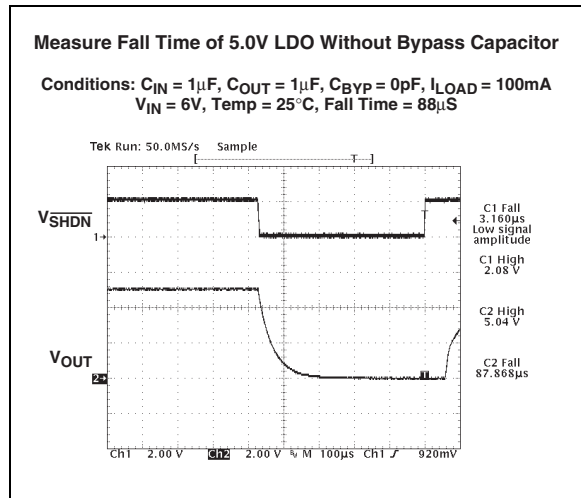
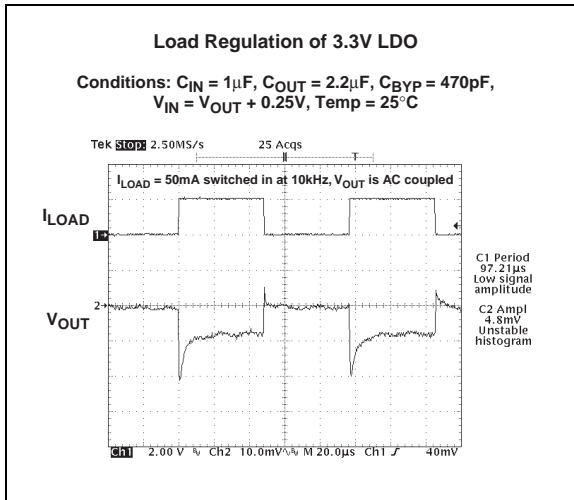

**FIGURE 2-24:** Measure Fall Time of 5.0V without Bypass Capacitor.



## TYPICAL PERFORMANCE CURVES (CONTINUED)

**Note:** Unless otherwise specified, all parts are measured at temperature = +25°C.



**FIGURE 2-25:** Load Regulation of 3.3V LDO.



**FIGURE 2-27:** Load Regulation of 3.3V LDO.

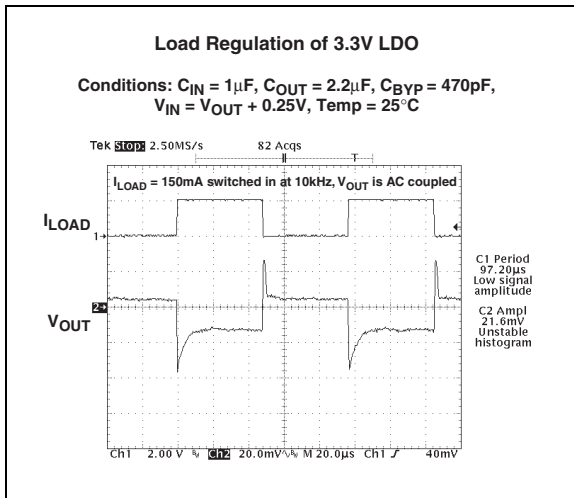

**FIGURE 2-26:** Load Regulation of 3.3V LDO.

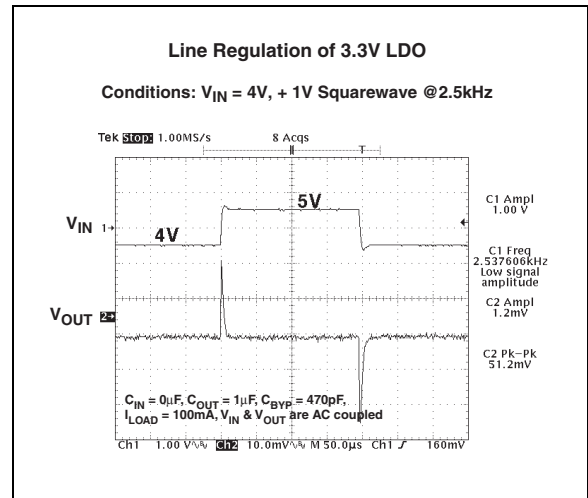

**FIGURE 2-28:** Load Regulation of 3.3V LDO.

# TC1014/TC1015/TC1185

## TYPICAL PERFORMANCE CURVES (CONTINUED)

**Note:** Unless otherwise specified, all parts are measured at temperature = +25°C.



**FIGURE 2-29:** Line Regulation of 5.0V LDO.

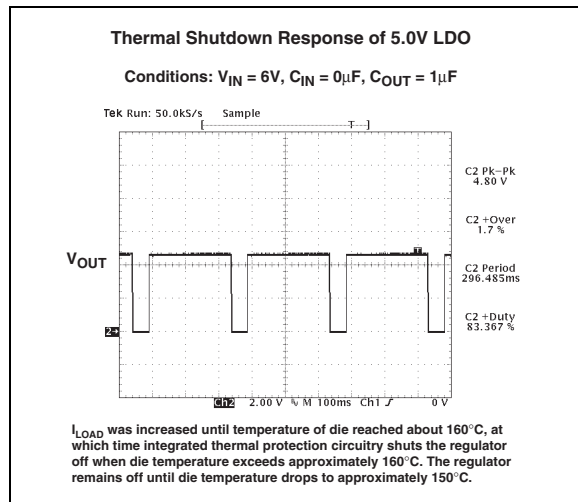

**FIGURE 2-30:** Thermal Shutdown Response of 5.0V LDO.

## 3.0 PIN DESCRIPTIONS

The descriptions of the pins are listed in [Table 3-1](#).

**TABLE 3-1: PIN FUNCTION TABLE**

Pin No. (5-Pin SOT-23)	Symbol	Description
1	$V_{IN}$	Unregulated supply input.
2	GND	Ground terminal.
3	$\overline{\text{SHDN}}$	Shutdown control input. The regulator is fully enabled when a logic high is applied to this input. The regulator enters shutdown when a logic low is applied to this input. During shutdown, output voltage falls to zero and supply current is reduced to 0.5 $\mu\text{A}$ (maximum).
4	Bypass	Reference bypass input. Connecting a 470 pF to this input further reduces output noise.
5	$V_{OUT}$	Regulated voltage output.

### 3.1 Input Voltage ( $V_{IN}$ )

Connect the  $V_{IN}$  pin to the unregulated source voltage. Like all low dropout linear regulators, low source impedance is necessary for the stable operation of the LDO. The amount of capacitance required to ensure low source impedance will depend on the proximity of the input source capacitors or battery type. For most applications, 1.0  $\mu\text{F}$  of capacitance will ensure stable operation of the LDO circuit. The type of capacitor used can be ceramic, tantalum or aluminum electrolytic. The low Effective Series Resistance (ESR) characteristics of the ceramic will yield better noise and Power Supply Ripple Rejection (PSRR) performance at high frequency.

### 3.2 Ground Terminal (GND)

Connect the ground pin to the input voltage return. For the optimal noise and PSRR performance, the GND pin of the LDO should be tied to a quiet circuit ground. For applications have switching or noisy inputs tie the GND pin to the return of the output capacitor. Ground planes help lower inductance and voltage spikes caused by fast transient load currents and are recommended for applications that are subjected to fast load transients.

### 3.3 Shutdown ( $\overline{\text{SHDN}}$ )

The Shutdown input is used to turn the LDO on and off. When the  $\overline{\text{SHDN}}$  pin is at a logic high level, the LDO output is enabled. When the  $\overline{\text{SHDN}}$  pin is pulled to a logic low, the LDO output is disabled. When disabled, the quiescent current used by the LDO is less than 0.5  $\mu\text{A}$  max.

### 3.4 Bypass

Connecting a low-value ceramic capacitor to the Bypass pin will further reduce output voltage noise and improve the PSRR performance of the LDO. While smaller and larger values can be used, these affect the speed at which the LDO output voltage rises when the input power is applied. The larger the bypass capacitor, the slower the output voltage will rise.

### 3.5 Output Voltage ( $V_{OUT}$ )

Connect the output load to  $V_{OUT}$  of the LDO. Also connect one side of the LDO output capacitor as close as possible to the  $V_{OUT}$  pin.

# TC1014/TC1015/TC1185

## 4.0 DETAILED DESCRIPTION

The TC1014, TC1015 and TC1185 are precision fixed output voltage regulators (if an adjustable version is needed, see the TC1070, TC1071 and TC1187 data sheet (DS21353). Unlike bipolar regulators, the TC1014, TC1015 and TC1185 supply current does not increase with load current. In addition, the LDOs' output voltage is stable using 1  $\mu\text{F}$  of capacitance over the entire specified input voltage range and output current range.

Figure 4-1 shows a typical application circuit. The regulator is enabled anytime the shutdown input (SHDN) is at or above  $V_{IH}$ , and disabled when SHDN is at or below  $V_{IL}$ . SHDN may be controlled by a CMOS logic gate or I/O port of a microcontroller. If the SHDN input is not required, it should be connected directly to the input supply. While in shutdown, the supply current decreases to 0.05  $\mu\text{A}$  (typical) and  $V_{OUT}$  falls to zero volts.

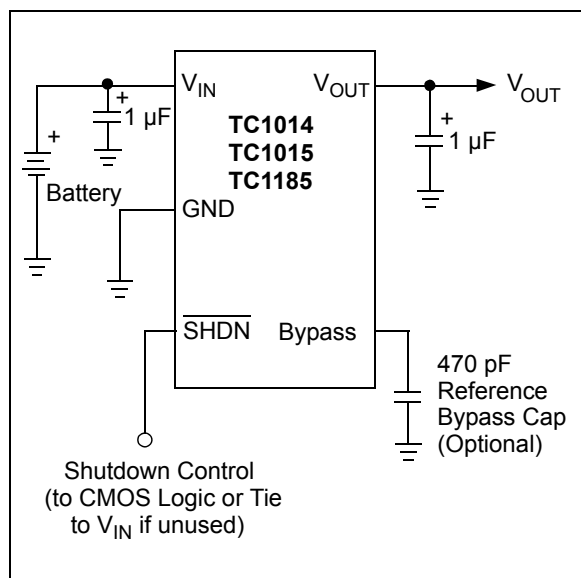

FIGURE 4-1: Typical Application Circuit.

## 4.1 Bypass Input

A 470 pF capacitor connected from the Bypass input to ground reduces noise present on the internal reference, which in turn, significantly reduces output noise. If output noise is not a concern, this input may be left unconnected. Larger capacitor values may be used, but results in a longer time period to rated output voltage when power is initially applied.

## 4.2 Output Capacitor

A 1  $\mu\text{F}$  (min) capacitor from  $V_{OUT}$  to ground is required. The output capacitor should have an effective series resistance greater than 0.1  $\Omega$  and less than 5  $\Omega$ . A 1  $\mu\text{F}$  capacitor should be connected from  $V_{IN}$  to GND if there is more than 10 inches of wire between the regulator and the AC filter capacitor, or if a battery is used as the power source. Aluminum electrolytic or tantalum capacitor types can be used. (Since many aluminum electrolytic capacitors freeze at approximately -30°C, solid tantalums are recommended for applications operating below -25°C.) When operating from sources other than batteries, supply-noise rejection and transient response can be improved by increasing the value of the input and output capacitors and employing passive filtering techniques.

## 4.3 Input Capacitor

A 1  $\mu\text{F}$  capacitor should be connected from  $V_{IN}$  to GND if there is more than 10 inches of wire between the regulator and this AC filter capacitor, or if a battery is used as the power source. Aluminum electrolytic or tantalum capacitors can be used (since many aluminum electrolytic capacitors freeze at approximately -30°C, solid tantalum is recommended for applications operating below -25°C). When operating from sources other than batteries, supply-noise rejection and transient response can be improved by increasing the value of the input and output capacitors and employing passive filtering techniques.

## 5.0 THERMAL CONSIDERATIONS

### 5.1 Thermal Shutdown

Integrated thermal protection circuitry shuts the regulator off when die temperature exceeds 160°C. The regulator remains off until the die temperature drops to approximately 150°C.

### 5.2 Power Dissipation

The amount of power the regulator dissipates is primarily a function of input and output voltage, and output current. The following equation is used to calculate worst-case actual power dissipation:

#### EQUATION 5-1:

$$P_D \approx (V_{INMAX} - V_{OUTMIN}) I_{LOADMAX}$$

Where:

$P_D$  = Worst-case actual power dissipation

$V_{INMAX}$  = Maximum voltage on  $V_{IN}$

$V_{OUTMIN}$  = Minimum regulator output voltage

$I_{LOADMAX}$  = Maximum output (load) current

The maximum allowable power dissipation (Equation 5-2) is a function of the maximum ambient temperature ( $T_{AMAX}$ ), the maximum allowable die temperature ( $T_{JMAX}$ ) and the thermal resistance from junction-to-air ( $\theta_{JA}$ ). The 5-pin SOT-23 package has a  $\theta_{JA}$  of approximately 220°C/Watt.

#### EQUATION 5-2:

$$P_{DMAX} = \frac{(T_{JMAX} - T_{AMAX})}{\theta_{JA}}$$

Where all terms are previously defined.

Equation 5-1 can be used in conjunction with Equation 5-2 to ensure regulator thermal operation is within limits. For example:

Given:

$$V_{INMAX} = 3.0V + 10\%$$

$$V_{OUTMIN} = 2.7V - 2.5\%$$

$$I_{LOADMAX} = 40 \text{ mA}$$

$$T_{JMAX} = 125^\circ\text{C}$$

$$T_{AMAX} = 55^\circ\text{C}$$

Find:

1. Actual power dissipation
2. Maximum allowable dissipation

Actual power dissipation:

$$\begin{aligned} P_D &\approx (V_{INMAX} - V_{OUTMIN}) I_{LOADMAX} \\ &= [(3.0 \times 1.1) - (2.7 \times .975)] 40 \times 10^{-3} \\ &= 26.7 \text{ mW} \end{aligned}$$

Maximum allowable power dissipation:

$$\begin{aligned} P_{DMAX} &= \frac{(T_{JMAX} - T_{AMAX})}{\theta_{JA}} \\ &= \frac{(125 - 55)}{220} \\ &= 318 \text{ mW} \end{aligned}$$

In this example, the TC1014 dissipates a maximum of 26.7 mW below the allowable limit of 318 mW. In a similar manner, Equation 5-1 and Equation 5-2 can be used to calculate maximum current and/or input voltage limits.

### 5.3 Layout Considerations

The primary path of heat conduction out of the package is via the package leads. Therefore, layouts having a ground plane, wide traces at the pads, and wide power supply bus lines combine to lower  $\theta_{JA}$  and therefore increase the maximum allowable power dissipation limit.

# TC1014/TC1015/TC1185

## 6.0 PACKAGING INFORMATION

### 6.1 Package Marking Information

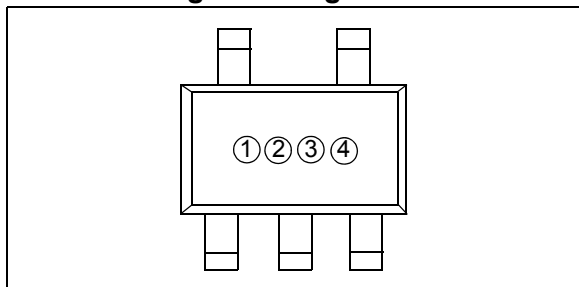

- ① & ② represents part number code + temperature range and voltage
- ③ represents year and 2-month period code
- ④ represents lot ID number

**TABLE 6-1: PART NUMBER CODE AND TEMPERATURE RANGE**

(V)	TC1014 Code	TC1015 Code	TC1185 Code
1.8	AY	BY	NY
2.5	A1	B1	N1
2.6	NB	BT	NT
2.7	A2	B2	N2
2.8	AZ	BZ	NZ
2.85	A8	B8	N8
3.0	A3	B3	N3
3.3	A5	B5	N5
3.6	A9	B9	N9
4.0	A0	B0	N0
5.0	A7	B7	N7

### 6.2 Taping Form

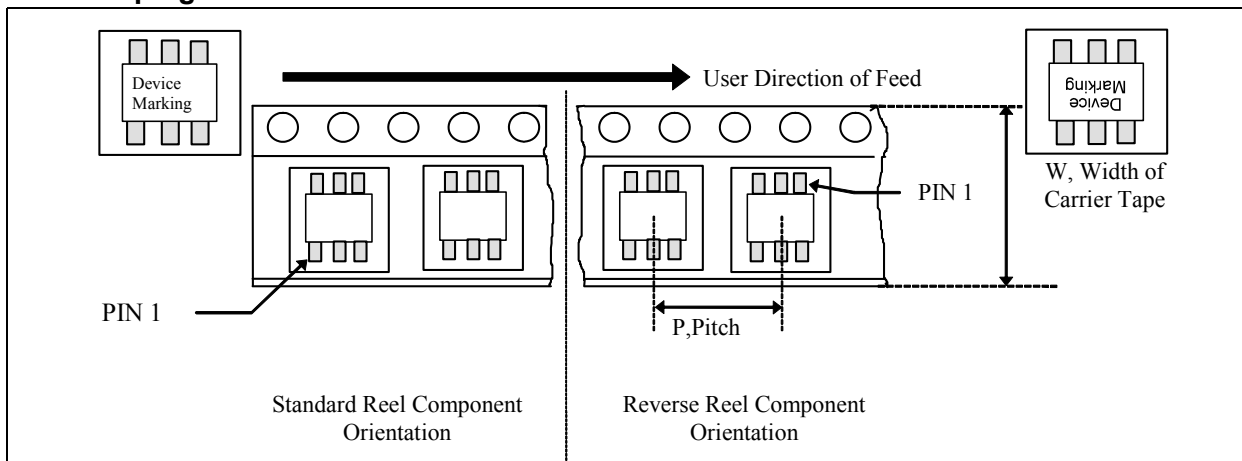

Carrier Tape, Number of Components per Reel and Reel Size

Package	Carrier Width (W)	Pitch (P)	Part Per Full Reel	Reel Size
5-Pin SOT-23	8 mm	4 mm	3000	7 in

# TC1014/TC1015/TC1185

## 5-Lead Plastic Small Outline Transistor (OT) [SOT-23]

**Note:** For the most current package drawings, please see the Microchip Packaging Specification located at <http://www.microchip.com/packaging>



Dimension Limits	Units	MILLIMETERS		
		MIN	NOM	MAX
Number of Pins	N	5		
Lead Pitch	e	0.95 BSC		
Outside Lead Pitch	e1	1.90 BSC		
Overall Height	A	0.90	–	1.45
Molded Package Thickness	A2	0.89	–	1.30
Standoff	A1	0.00	–	0.15
Overall Width	E	2.20	–	3.20
Molded Package Width	E1	1.30	–	1.80
Overall Length	D	2.70	–	3.10
Foot Length	L	0.10	–	0.60
Footprint	L1	0.35	–	0.80
Foot Angle	$\phi$	0°	–	30°
Lead Thickness	c	0.08	–	0.26
Lead Width	b	0.20	–	0.51

**Notes:**

- Dimensions D and E1 do not include mold flash or protrusions. Mold flash or protrusions shall not exceed 0.127 mm per side.
- Dimensioning and tolerancing per ASME Y14.5M.

BSC: Basic Dimension. Theoretically exact value shown without tolerances.

Microchip Technology Drawing C04-091B

# TC1014/TC1015/TC1185

---

NOTES:



## APPENDIX A: REVISION HISTORY

### Revision E (February 2007)

- **Section 1.0 “Electrical characteristics”:**  
Changed Dropout Voltage from mA to  $\mu$ A.
- Updated “**Product Identification System**”,  
page 19.
- Updated **Section 6.0 “Packaging Information”**.

### Revision D (April 2006)

- Removed “ERROR is open circuited” from  $\overline{\text{SHDN}}$   
pin description in Pin Function Table.
- Added verbiage for pinout descriptions in Pin  
Function Table.
- Replaced verbiage in first paragraph of Section  
4.0 Detailed Description.
- Added Section 4.3 Input Capacitor

### Revision C (January 2006)

- Changed TR suffix to 713 suffix in Taping Form in  
Package Marking Section

### Revision B (May 2002)

- Converted Telcom data sheet to Microchip  
standard for Analog Handbook

### Revision A (February 2001)

- Original Release of this Document under Telcom.

# TC1014/TC1015/TC1185

---

NOTES:

# TC1014/TC1015/TC1185

## PRODUCT IDENTIFICATION SYSTEM

To order or obtain information, e.g., on pricing or delivery, refer to the factory or the listed sales office.

<u>PART NO.</u>	<u>-X.X</u>	<u>X</u>	<u>XXXXX</u>
Device	Output Voltage	Temperature Range	Package
Device:	TC1014:	50 mA LDO with Shutdown and $V_{REF}$ Bypass	
	TC1015:	100 mA LDO with Shutdown and $V_{REF}$ Bypass	
	TC1185:	150 mA LDO with Shutdown and $V_{REF}$ Bypass	
Output Voltage:	1.8 = 1.8V		
	2.5 = 2.5V		
	2.6 = 2.6V		
	2.7 = 2.7V		
	2.8 = 2.8V		
	2.85 = 2.85V		
	3.0 = 3.0V		
	3.3 = 3.3V		
	3.6 = 3.6V		
	4.0 = 4.0V		
	5.0 = 5.0V		
Temperature Range:	V	= -40° C to +125° C	
Package:	CT713	= Plastic Small Outline Transistor (SOT-23), 5-lead, Tape and Reel	

**Examples:**

- a) TC1014-1.8VCT713: 1.8V, 5LD SOT-23, Tape and Reel.
- b) TC1014-2.85VCT713: 2.85V, 5LD SOT-23, Tape and Reel.
- c) TC1014-3.3VCT713: 3.3V, 5LD SOT-23, Tape and Reel.
- a) TC1015-1.8VCT713: 1.8V, 5LD SOT-23, Tape and Reel.
- b) TC1015-2.85VCT713: 2.85V, 5LD SOT-23, Tape and Reel.
- c) TC1015-3.0VCT713: 3.0V, 5LD SOT-23, Tape and Reel.
- a) TC1185-1.8VCT713: 1.8V, 5LD SOT-23, Tape and Reel.
- b) TC1185-2.8VCT713: 2.8V, 5LD SOT-23, Tape and Reel.

# TC1014/TC1015/TC1185

---

NOTES:

---

**Note the following details of the code protection feature on Microchip devices:**

- Microchip products meet the specification contained in their particular Microchip Data Sheet.
- Microchip believes that its family of products is one of the most secure families of its kind on the market today, when used in the intended manner and under normal conditions.
- There are dishonest and possibly illegal methods used to breach the code protection feature. All of these methods, to our knowledge, require using the Microchip products in a manner outside the operating specifications contained in Microchip's Data Sheets. Most likely, the person doing so is engaged in theft of intellectual property.
- Microchip is willing to work with the customer who is concerned about the integrity of their code.
- Neither Microchip nor any other semiconductor manufacturer can guarantee the security of their code. Code protection does not mean that we are guaranteeing the product as "unbreakable."

Code protection is constantly evolving. We at Microchip are committed to continuously improving the code protection features of our products. Attempts to break Microchip's code protection feature may be a violation of the Digital Millennium Copyright Act. If such acts allow unauthorized access to your software or other copyrighted work, you may have a right to sue for relief under that Act.

---

Information contained in this publication regarding device applications and the like is provided only for your convenience and may be superseded by updates. It is your responsibility to ensure that your application meets with your specifications. MICROCHIP MAKES NO REPRESENTATIONS OR WARRANTIES OF ANY KIND WHETHER EXPRESS OR IMPLIED, WRITTEN OR ORAL, STATUTORY OR OTHERWISE, RELATED TO THE INFORMATION, INCLUDING BUT NOT LIMITED TO ITS CONDITION, QUALITY, PERFORMANCE, MERCHANTABILITY OR FITNESS FOR PURPOSE. Microchip disclaims all liability arising from this information and its use. Use of Microchip devices in life support and/or safety applications is entirely at the buyer's risk, and the buyer agrees to defend, indemnify and hold harmless Microchip from any and all damages, claims, suits, or expenses resulting from such use. No licenses are conveyed, implicitly or otherwise, under any Microchip intellectual property rights.

**Trademarks**

The Microchip name and logo, the Microchip logo, Accuron, dsPIC, KEELOQ, KEELOQ logo, microID, MPLAB, PIC, PICmicro, PICSTART, PRO MATE, PowerSmart, rPIC, and SmartShunt are registered trademarks of Microchip Technology Incorporated in the U.S.A. and other countries.

AmpLab, FilterLab, Linear Active Thermistor, Migratable Memory, MXDEV, MXLAB, PS logo, SEEVAL, SmartSensor and The Embedded Control Solutions Company are registered trademarks of Microchip Technology Incorporated in the U.S.A.

Analog-for-the-Digital Age, Application Maestro, CodeGuard, dsPICDEM, dsPICDEM.net, dsPICworks, ECAN, ECONOMONITOR, FanSense, FlexROM, fuzzyLAB, In-Circuit Serial Programming, ICSP, ICEPIC, Mindi, MiWi, MPASM, MPLAB Certified logo, MPLIB, MPLINK, PICkit, PICDEM, PICDEM.net, PICLAB, PICtail, PowerCal, PowerInfo, PowerMate, PowerTool, REAL ICE, rLAB, rfPICDEM, Select Mode, Smart Serial, SmartTel, Total Endurance, UNI/O, WiperLock and ZENA are trademarks of Microchip Technology Incorporated in the U.S.A. and other countries.

SQTP is a service mark of Microchip Technology Incorporated in the U.S.A.

All other trademarks mentioned herein are property of their respective companies.

© 2007, Microchip Technology Incorporated, Printed in the U.S.A., All Rights Reserved.

 Printed on recycled paper.

*Microchip received ISO/TS-16949:2002 certification for its worldwide headquarters, design and wafer fabrication facilities in Chandler and Tempe, Arizona, Gresham, Oregon and Mountain View, California. The Company's quality system processes and procedures are for its PIC<sup>®</sup> MCUs and dsPIC<sup>®</sup> DSCs, KEELOQ<sup>®</sup> code hopping devices, Serial EEPROMs, microperipherals, nonvolatile memory and analog products. In addition, Microchip's quality system for the design and manufacture of development systems is ISO 9001:2000 certified.*

**QUALITY MANAGEMENT SYSTEM**  
**CERTIFIED BY DNV**  
**== ISO/TS 16949:2002 ==**



---

## WORLDWIDE SALES AND SERVICE

---

### AMERICAS

**Corporate Office**  
2355 West Chandler Blvd.  
Chandler, AZ 85224-6199  
Tel: 480-792-7200  
Fax: 480-792-7277  
Technical Support:  
<http://support.microchip.com>  
Web Address:  
[www.microchip.com](http://www.microchip.com)

**Atlanta**  
Duluth, GA  
Tel: 678-957-9614  
Fax: 678-957-1455

**Boston**  
Westborough, MA  
Tel: 774-760-0087  
Fax: 774-760-0088

**Chicago**  
Itasca, IL  
Tel: 630-285-0071  
Fax: 630-285-0075

**Dallas**  
Addison, TX  
Tel: 972-818-7423  
Fax: 972-818-2924

**Detroit**  
Farmington Hills, MI  
Tel: 248-538-2250  
Fax: 248-538-2260

**Kokomo**  
Kokomo, IN  
Tel: 765-864-8360  
Fax: 765-864-8387

**Los Angeles**  
Mission Viejo, CA  
Tel: 949-462-9523  
Fax: 949-462-9608

**Santa Clara**  
Santa Clara, CA  
Tel: 408-961-6444  
Fax: 408-961-6445

**Toronto**  
Mississauga, Ontario,  
Canada  
Tel: 905-673-0699  
Fax: 905-673-6509

### ASIA/PACIFIC

**Asia Pacific Office**  
Suites 3707-14, 37th Floor  
Tower 6, The Gateway  
Harbour City, Kowloon  
Hong Kong  
Tel: 852-2401-1200  
Fax: 852-2401-3431

**Australia - Sydney**  
Tel: 61-2-9868-6733  
Fax: 61-2-9868-6755

**China - Beijing**  
Tel: 86-10-8528-2100  
Fax: 86-10-8528-2104

**China - Chengdu**  
Tel: 86-28-8665-5511  
Fax: 86-28-8665-7889

**China - Fuzhou**  
Tel: 86-591-8750-3506  
Fax: 86-591-8750-3521

**China - Hong Kong SAR**  
Tel: 852-2401-1200  
Fax: 852-2401-3431

**China - Qingdao**  
Tel: 86-532-8502-7355  
Fax: 86-532-8502-7205

**China - Shanghai**  
Tel: 86-21-5407-5533  
Fax: 86-21-5407-5066

**China - Shenyang**  
Tel: 86-24-2334-2829  
Fax: 86-24-2334-2393

**China - Shenzhen**  
Tel: 86-755-8203-2660  
Fax: 86-755-8203-1760

**China - Shunde**  
Tel: 86-757-2839-5507  
Fax: 86-757-2839-5571

**China - Wuhan**  
Tel: 86-27-5980-5300  
Fax: 86-27-5980-5118

**China - Xian**  
Tel: 86-29-8833-7250  
Fax: 86-29-8833-7256

### ASIA/PACIFIC

**India - Bangalore**  
Tel: 91-80-4182-8400  
Fax: 91-80-4182-8422

**India - New Delhi**  
Tel: 91-11-4160-8631  
Fax: 91-11-4160-8632

**India - Pune**  
Tel: 91-20-2566-1512  
Fax: 91-20-2566-1513

**Japan - Yokohama**  
Tel: 81-45-471-6166  
Fax: 81-45-471-6122

**Korea - Gumi**  
Tel: 82-54-473-4301  
Fax: 82-54-473-4302

**Korea - Seoul**  
Tel: 82-2-554-7200  
Fax: 82-2-558-5932 or  
82-2-558-5934

**Malaysia - Penang**  
Tel: 60-4-646-8870  
Fax: 60-4-646-5086

**Philippines - Manila**  
Tel: 63-2-634-9065  
Fax: 63-2-634-9069

**Singapore**  
Tel: 65-6334-8870  
Fax: 65-6334-8850

**Taiwan - Hsin Chu**  
Tel: 886-3-572-9526  
Fax: 886-3-572-6459

**Taiwan - Kaohsiung**  
Tel: 886-7-536-4818  
Fax: 886-7-536-4803

**Taiwan - Taipei**  
Tel: 886-2-2500-6610  
Fax: 886-2-2508-0102

**Thailand - Bangkok**  
Tel: 66-2-694-1351  
Fax: 66-2-694-1350

### EUROPE

**Austria - Wels**  
Tel: 43-7242-2244-39  
Fax: 43-7242-2244-393

**Denmark - Copenhagen**  
Tel: 45-4450-2828  
Fax: 45-4485-2829

**France - Paris**  
Tel: 33-1-69-53-63-20  
Fax: 33-1-69-30-90-79

**Germany - Munich**  
Tel: 49-89-627-144-0  
Fax: 49-89-627-144-44

**Italy - Milan**  
Tel: 39-0331-742611  
Fax: 39-0331-466781

**Netherlands - Drunen**  
Tel: 31-416-690399  
Fax: 31-416-690340

**Spain - Madrid**  
Tel: 34-91-708-08-90  
Fax: 34-91-708-08-91

**UK - Wokingham**  
Tel: 44-118-921-5869  
Fax: 44-118-921-5820



Компания «ЭлектроПласт» предлагает заключение долгосрочных отношений при поставках импортных электронных компонентов на взаимовыгодных условиях!

Наши преимущества:

- Оперативные поставки широкого спектра электронных компонентов отечественного и импортного производства напрямую от производителей и с крупнейших мировых складов;
- Поставка более 17-ти миллионов наименований электронных компонентов;
- Поставка сложных, дефицитных, либо снятых с производства позиций;
- Оперативные сроки поставки под заказ (от 5 рабочих дней);
- Экспресс доставка в любую точку России;
- Техническая поддержка проекта, помощь в подборе аналогов, поставка прототипов;
- Система менеджмента качества сертифицирована по Международному стандарту ISO 9001;
- Лицензия ФСБ на осуществление работ с использованием сведений, составляющих государственную тайну;
- Поставка специализированных компонентов (Xilinx, Altera, Analog Devices, Intersil, Interpoint, Microsemi, Aeroflex, Peregrine, Syfer, Eurofarad, Texas Instrument, Miteq, Cobham, E2V, MA-COM, Hittite, Mini-Circuits, General Dynamics и др.);

Помимо этого, одним из направлений компании «ЭлектроПласт» является направление «Источники питания». Мы предлагаем Вам помощь Конструкторского отдела:

- Подбор оптимального решения, техническое обоснование при выборе компонента;
- Подбор аналогов;
- Консультации по применению компонента;
- Поставка образцов и прототипов;
- Техническая поддержка проекта;
- Защита от снятия компонента с производства.



#### Как с нами связаться

**Телефон:** 8 (812) 309 58 32 (многоканальный)

**Факс:** 8 (812) 320-02-42

**Электронная почта:** [org@eplast1.ru](mailto:org@eplast1.ru)

**Адрес:** 198099, г. Санкт-Петербург, ул. Калинина, дом 2, корпус 4, литера А.