

# 10MHz, Rail-to-Rail Input and Output Op Amp in SOT-23

## FEATURES

- Rail-to-Rail Input and Output
- Small SOT-23 Package
- Gain Bandwidth Product: 10MHz
- -40°C to 85°C Operation
- Slew Rate: 2.25V/μs
- Low Input Offset Voltage: 1.5mV Max
- High Output Current: 25mA Min
- Specified on 3V, 5V and ±5V Supplies
- High Voltage Gain: 1000V/mV 10k Load
- High CMRR: 96dB Typ
- High PSRR: 90dB Typ
- Input Bias Current: 300nA Max
- Input Offset Current: 25nA Max
- Low Profile (1mm) SOT-23 (ThinSOT™) Package

## APPLICATIONS

- Portable Instrumentation
- Rail-to-Rail Buffer Amplifiers
- Low Voltage Signal Processing
- Driving A/D Converters
- Battery-Powered Systems

## DESCRIPTION

The LT<sup>®</sup>1797 is a unity-gain stable 10MHz op amp available in the small SOT-23 package that operates on all single and split supplies with a total voltage of 2.7V to 12V. The amplifier draws 1mA of quiescent current and has a slew rate of 2.25V/μs.

The input common mode range of the LT1797 includes both rails, making it ideal for current sensing applications. The input stage incorporates phase reversal protection to prevent false outputs from occurring when the inputs are driven beyond the supplies. Protective resistors are included in the input leads so that current does not become excessive when the inputs are forced above or below the supplies.

The output of the LT1797 can swing to within 50mV of V<sup>+</sup> and 8mV of V<sup>-</sup> without drawing excess current in either condition. The amplifier can drive loads up to 25mA and still maintain rail-to-rail capability.

The LT1797 op amp is available in the space saving 5-lead SOT-23 package.

LT, LT, LTC, LTM, Linear Technology and the Linear logo are registered trademarks and ThinSOT and Over-The-Top are trademarks of Analog Devices, Inc. All other trademarks are the property of their respective owners.

## TYPICAL APPLICATION

Fast Compact -48V Current Sense

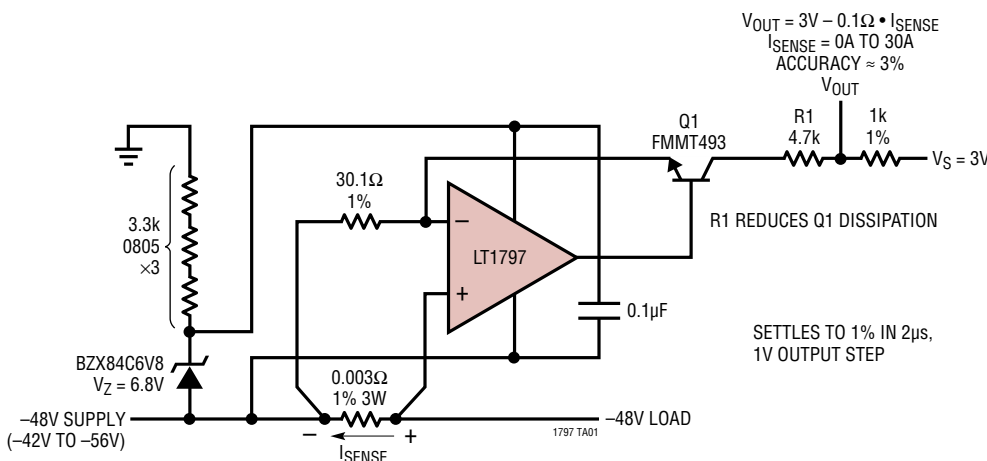

Small-Signal Response

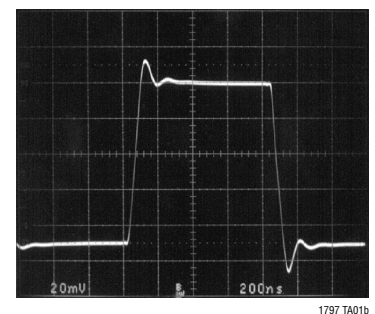

$V_S = \pm 2.5V$   
 $A_V = 1$   
 $R_L = 10k$

## ABSOLUTE MAXIMUM RATINGS

(Note 1)

Total Supply Voltage ( $V^+$ to $V^-$ ) .....	12.6V
Input Differential Voltage .....	12.6V
Input Current.....	$\pm 10\text{mA}$
Output Short-Circuit Duration (Note 2) .....	Continuous
Operating Temperature Range (Note 3)....	$-40^\circ\text{C}$ to $85^\circ\text{C}$
Specified Temperature Range .....	$-40^\circ\text{C}$ to $85^\circ\text{C}$
Junction Temperature .....	$150^\circ\text{C}$
Storage Temperature Range .....	$-65^\circ\text{C}$ to $150^\circ\text{C}$
Lead Temperature (Soldering, 10 sec).....	$300^\circ\text{C}$

## PIN CONFIGURATION

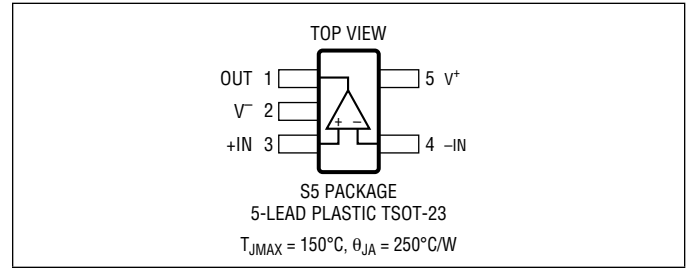

## ORDER INFORMATION <http://www.linear.com/product/LT1797#orderinfo>

LEAD FREE FINISH	TAPE AND REEL	PART MARKING	PACKAGE DESCRIPTION	TEMPERATURE RANGE
LT1797CS5#PBF	LT1797CS5#TRPBF	LTLM	5-Lead Plastic TSOT-23	$-40^\circ\text{C}$ to $85^\circ\text{C}$
LT1797IS5#PBF	LT1797IS5#TRPBF	LTTL	5-Lead Plastic TSOT-23	$-40^\circ\text{C}$ to $85^\circ\text{C}$

Consult LTC Marketing for parts specified with wider operating temperature ranges.

For more information on lead free part marking, go to: <http://www.linear.com/leadfree/>

For more information on tape and reel specifications, go to: <http://www.linear.com/tapeandreel/>. Some packages are available in 500 unit reels through designated sales channels with #TRMPBF suffix.

## ELECTRICAL CHARACTERISTICS

The ● denotes the specifications which apply over the full operating temperature range, otherwise specifications are at  $T_A = 25^\circ\text{C}$ .  $V_S = 3\text{V}, 0\text{V}$ ;  $V_S = 5\text{V}, 0\text{V}$ ,  $V_{CM} = V_{OUT} = \text{half supply}$ , pulse power tested, unless otherwise specified. (Note 3)

SYMBOL	PARAMETER	CONDITIONS	MIN	TYP	MAX	UNITS
$V_{OS}$	Input Offset Voltage	$0^\circ\text{C} \leq T_A \leq 70^\circ\text{C}$	●	1	1.5	mV
		$-40^\circ\text{C} \leq T_A \leq 85^\circ\text{C}$	●		2.5	mV
	Input Offset Voltage Drift (Note 4)		●	5	20	$\mu\text{V}/^\circ\text{C}$
$I_B$	Input Bias Current	$V_{CM} = V^-$	●	-300	-150	nA
		$V_{CM} = V^+$	●		50	100
	Input Bias Current Drift		●	0.1		$\text{nA}/^\circ\text{C}$
$I_{OS}$	Input Offset Current	$V_{CM} = V^-$	●	10	25	nA
		$V_{CM} = V^+$	●	10	25	nA
	Input Noise Voltage	0.1Hz to 10Hz		1.5		$\mu\text{V}_{P-P}$
$e_n$	Input Noise Voltage Density	$f = 10\text{kHz}$		20		$\text{nV}/\sqrt{\text{Hz}}$
$i_n$	Input Noise Current Density	$f = 10\text{kHz}$		0.23		$\text{pA}/\sqrt{\text{Hz}}$
		$f = 10\text{kHz}, V_{CM} = V_{CC} - 0.3\text{V}$		0.15		$\text{pA}/\sqrt{\text{Hz}}$
$R_{IN}$	Input Resistance	Differential		200	330	$\text{k}\Omega$
		Common Mode, $V_{CM} = 0\text{V}$ to $V_S - 1.3\text{V}$			100	$\text{M}\Omega$
$C_{IN}$	Input Capacitance			4		pF
CMRR	Common Mode Rejection Ratio	$V_{CM} = 0\text{V}$ to $V_S - 1.3\text{V}$	●	82	96	dB
		$V_S = 5\text{V}, V_{CM} = 0\text{V}$ to $5\text{V}$	●	64	72	dB
		$V_S = 3\text{V}, V_{CM} = 0\text{V}$ to $3\text{V}$	●	60	68	dB

**ELECTRICAL CHARACTERISTICS** The ● denotes the specifications which apply over the full operating temperature range, otherwise specifications are at  $T_A = 25^\circ\text{C}$ .  $V_S = 3\text{V}, 0\text{V}$ ;  $V_S = 5\text{V}, 0\text{V}$ ,  $V_{\text{CM}} = V_{\text{OUT}} = \text{half supply}$ , pulse power tested, unless otherwise specified. (Note 3)

SYMBOL	PARAMETER	CONDITIONS	MIN	TYP	MAX	UNITS	
	Input Voltage Range		●	0	$V_S$	V	
$A_{\text{VOL}}$	Large-Signal Voltage Gain	$V_S = 3\text{V}, V_O = 0.5\text{V to } 2.5\text{V}, R_L = 10\text{k}$	●	200	1000	V/mV	
		$V_S = 5\text{V}, V_O = 0.5\text{V to } 4.5\text{V}, R_L = 10\text{k}$	●	150	1000	V/mV	
PSRR	Power Supply Rejection Ratio	$V_S = 2.7\text{V to } 12\text{V}, V_{\text{CM}} = V_O = 1\text{V}$	●	80	90	dB	
	Minimum Supply Voltage		●	2.5	2.7	V	
$V_{\text{OL}}$	Output Voltage Swing LOW	No Load, Input Overdrive = 30mV	●		8	30	mV
		$I_{\text{SINK}} = 5\text{mA}$	●		80	160	mV
		$I_{\text{SINK}} = 10\text{mA}$	●		150	250	mV
$V_{\text{OH}}$	Output Voltage Swing HIGH	No Load, Input Overdrive = 30mV	●	$V_S - 0.14$	$V_S - 0.05$	V	
		$I_{\text{SOURCE}} = 5\text{mA}$	●	$V_S - 0.30$	$V_S - 0.2$	V	
		$I_{\text{SOURCE}} = 10\text{mA}, V_S = 5\text{V}$	●	$V_S - 0.39$	$V_S - 0.3$	V	
		$I_{\text{SOURCE}} = 10\text{mA}, V_S = 3\text{V}$	●	$V_S - 0.59$	$V_S - 0.3$	V	
$I_{\text{SC}}$	Short-Circuit Current	$V_S = 5\text{V}$		25	45	mA	
		$V_S = 3\text{V}$		15	25	mA	
$I_S$	Supply Current		●		1.1	1.5	mA
GBW	Gain Bandwidth Product (Note 5)	$f = 100\text{kHz}$	●	6.0	10	MHz	
		$0^\circ\text{C} \leq T_A \leq 70^\circ\text{C}$	●	5.0		MHz	
		$-40^\circ\text{C} \leq T_A \leq 85^\circ\text{C}$	●	4.5		MHz	
SR	Slew Rate (Note 5)	$A_V = -1$	●	1.3	2.25	V/ $\mu\text{s}$	
		$0^\circ\text{C} \leq T_A \leq 70^\circ\text{C}$	●	1.1		V/ $\mu\text{s}$	
		$-40^\circ\text{C} \leq T_A \leq 85^\circ\text{C}$	●	1.0		V/ $\mu\text{s}$	
$t_r$	Output Rise Time	10% to 90%, 0.1V Step, $R_L = 10\text{k}$		55		ns	
$t_f$	Output Fall Time	10% to 90%, 0.1V Step, $R_L = 10\text{k}$		55		ns	
$t_s$	Settling Time	$V_S = 5\text{V}, \Delta V_{\text{OUT}} = 2\text{V to } 0.1\%, A_V = -1$		1.6		$\mu\text{s}$	
THD	Distortion	$V_S = 3\text{V}, V_{\text{OUT}} = 1.8\text{V}_{\text{P-P}}, A_V = 1, R_L = 10\text{k}, f = 1\text{kHz}$		0.001		%	
FPBW	Full-Power Bandwidth (Note 6)	$V_{\text{OUT}} = 2\text{V}_{\text{P-P}}$		360		kHz	

The ● denotes the specifications which apply over the full operating temperature range, otherwise specifications are at  $T_A = 25^\circ\text{C}$ .  $V_S = \pm 5\text{V}, V_{\text{CM}} = 0\text{V}, V_{\text{OUT}} = 0\text{V}$ , pulse power tested unless otherwise specified. (Note 3)

SYMBOL	PARAMETER	CONDITIONS	MIN	TYP	MAX	UNITS
$V_{\text{OS}}$	Input Offset Voltage	$0^\circ\text{C} \leq T_A \leq 70^\circ\text{C}$	●	1	1.5	mV
		$-40^\circ\text{C} \leq T_A \leq 85^\circ\text{C}$	●		2.5	mV
			●		3.0	mV
	Input Offset Voltage Drift (Note 4)		●	5	20	$\mu\text{V}/^\circ\text{C}$
$I_B$	Input Bias Current	$V_{\text{CM}} = V^-$	●	-300	-150	nA
		$V_{\text{CM}} = V^+$	●		50	100
	Input Bias Current Drift		●	0.1		nA/ $^\circ\text{C}$
$I_{\text{OS}}$	Input Offset Current	$V_{\text{CM}} = V^-$	●	10	25	nA
		$V_{\text{CM}} = V^+$	●	10	25	nA
	Input Noise Voltage	0.1Hz to 10Hz		1		$\mu\text{V}_{\text{P-P}}$
$e_n$	Input Noise Voltage Density	$f = 10\text{kHz}$		20		nV/ $\sqrt{\text{Hz}}$
$i_n$	Input Noise Current Density	$f = 10\text{kHz}$		0.23		pA/ $\sqrt{\text{Hz}}$
		$f = 10\text{kHz}, V_{\text{CM}} = 4.7\text{V}$		0.15		pA/ $\sqrt{\text{Hz}}$

## ELECTRICAL CHARACTERISTICS

The ● denotes the specifications which apply over the full operating temperature range, otherwise specifications are at  $T_A = 25^\circ\text{C}$ .  $V_S = \pm 5\text{V}$ ,  $V_{CM} = 0\text{V}$ ,  $V_{OUT} = 0\text{V}$ , pulse power tested unless otherwise specified. (Note 3)

SYMBOL	PARAMETER	CONDITIONS	MIN	TYP	MAX	UNITS
$R_{IN}$	Input Resistance	Differential Common Mode, $V_{CM} = -5\text{V to } 3.7\text{V}$	200	330 100		$k\Omega$ $M\Omega$
$C_{IN}$	Input Capacitance			4		pF
	Input Voltage Range		● -5		5	V
CMRR	Common Mode Rejection Ratio	$V_{CM} = -5\text{V to } 3.7\text{V}$ $V_{CM} = -5\text{V to } 5\text{V}$	● 78 ● 66	96 76		dB dB
$A_{VOL}$	Large-Signal Voltage Gain	$V_O = \pm 4\text{V}$ , $R_L = 10k$	● 400 ● 300	1000		V/mV V/mV
$V_{OL}$	Output Voltage Swing LOW	No Load, Input Overdrive = 30mV $I_{SINK} = 5\text{mA}$ $I_{SINK} = 10\text{mA}$	● ● ●	-4.99 -4.92 -4.85	-4.97 -4.87 -4.79	V V V
$V_{OH}$	Output Voltage Swing HIGH	No Load, Input Overdrive = 30mV $I_{SOURCE} = 5\text{mA}$ $I_{SOURCE} = 10\text{mA}$	● ● ●	4.84 4.70 4.61	4.95 4.80 4.70	V V V
$I_{SC}$	Short-Circuit Current (Note 2)	Short to GND		30	50	mA
PSRR	Power Supply Rejection Ratio	$V_S = \pm 1.35\text{V to } \pm 6\text{V}$	●	80	90	dB
$I_S$	Supply Current		●	1.40	2.25 3.00	mA mA
GBW	Gain Bandwidth Product	$f = 100\text{kHz}$ $0^\circ\text{C} \leq T_A \leq 70^\circ\text{C}$ $-40^\circ\text{C} \leq T_A \leq 85^\circ\text{C}$	● ●	6.5 5.5 5.0	11	MHz MHz MHz
SR	Slew Rate	$A_V = -1$ , $R_L = \infty$ , $V_O = \pm 4\text{V}$ , Measured at $V_O = \pm 2\text{V}$ $0^\circ\text{C} \leq T_A \leq 70^\circ\text{C}$ $-40^\circ\text{C} \leq T_A \leq 85^\circ\text{C}$	● ●	1.50 1.25 1.10	2.50	V/ $\mu\text{s}$ V/ $\mu\text{s}$ V/ $\mu\text{s}$
$t_r$	Output Rise Time	10% to 90%, 0.1V Step, $R_L = 10k$		55		ns
$t_f$	Output Fall Time	10% to 90%, 0.1V Step, $R_L = 10k$		55		ns
$t_S$	Settling Time	$\Delta V_{OUT} = 4\text{V to } 0.1\%$ , $A_V = 1$		2.6		$\mu\text{s}$
FPBW	Full-Power Bandwidth (Note 6)	$V_{OUT} = 8V_{P-P}$		100		kHz

**Note 1:** Stresses beyond those listed under Absolute Maximum Ratings may cause permanent damage to the device. Exposure to any Absolute Maximum Rating condition for extended periods may affect device reliability and lifetime.

**Note 2:** A heat sink may be required to keep the junction temperature below absolute maximum.

**Note 3:** The LT1797C is guaranteed to meet  $0^\circ\text{C}$  to  $70^\circ\text{C}$  specifications and is designed, characterized and expected to meet the extended temperature limits, but is not tested at  $-40^\circ\text{C}$  and  $85^\circ\text{C}$ . The LT1797I is guaranteed to meet specified performance from  $-40^\circ\text{C}$  to  $85^\circ\text{C}$ .

**Note 4:** This parameter is not 100% tested.

**Note 5:**  $V_S = 3\text{V}$  limit guaranteed by correlation to 5V tests.

**Note 6:** Full-power bandwidth is calculated from the slew rate:  
 $FPBW = SR/2\pi VP$

# TYPICAL PERFORMANCE CHARACTERISTICS

**Supply Current vs Supply Voltage**

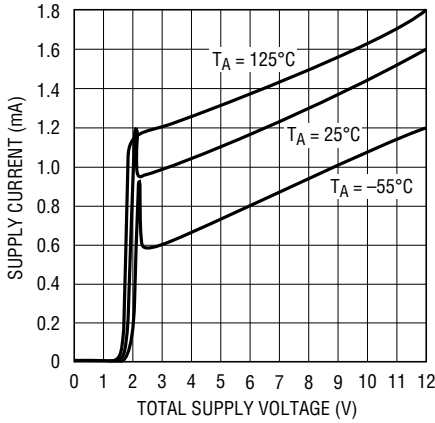

1797 G01

**Minimum Supply Voltage**

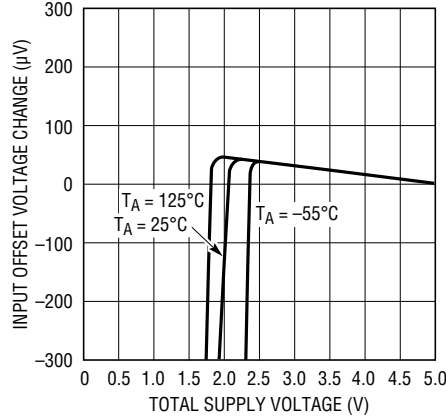

1797 G02

**Input Bias Current vs Common Mode Voltage**

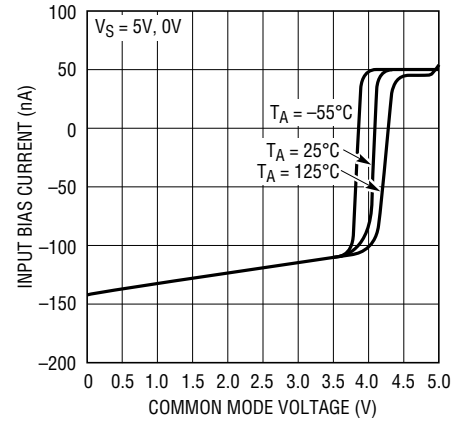

1797 G03

**Output Saturation Voltage vs Load Current (Output High)**

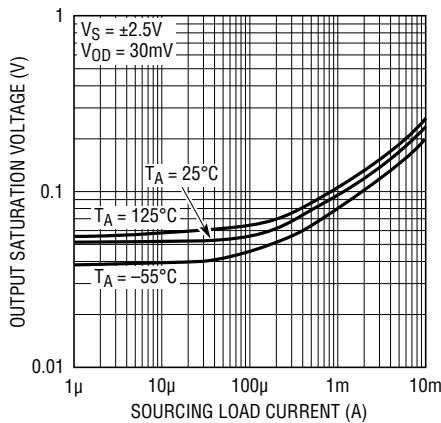

1797 G04

**Output Saturation Voltage vs Load Current (Output Low)**

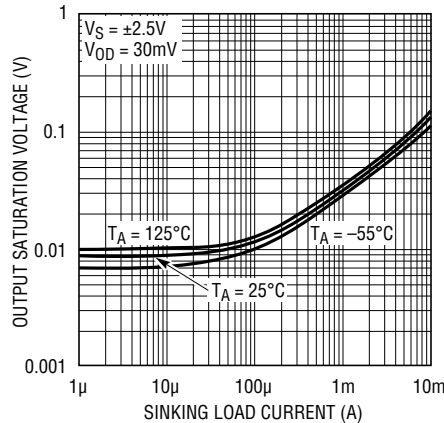

1797 G05

**Output Saturation Voltage vs Input Overdrive**

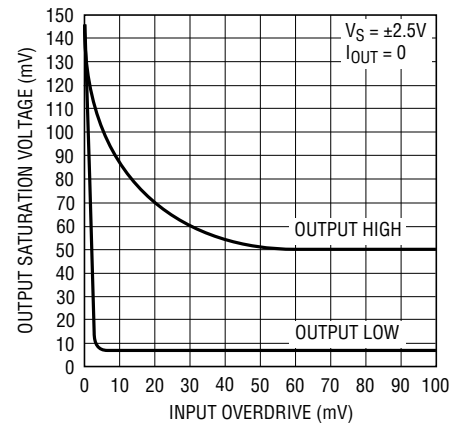

1797 G06

**Output Short-Circuit Current vs Temperature**

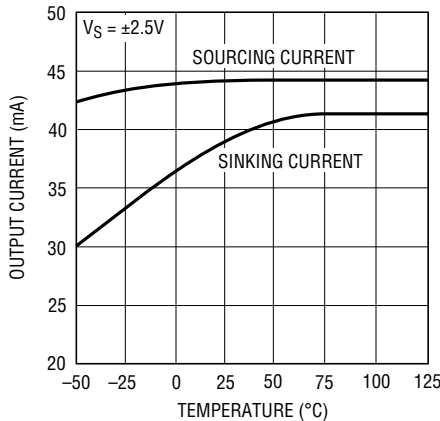

1797 G07

**0.1Hz to 10Hz Noise Voltage**

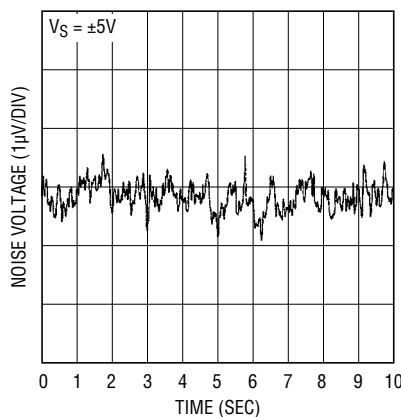

1797 G08

**Input Noise Voltage Density vs Frequency**

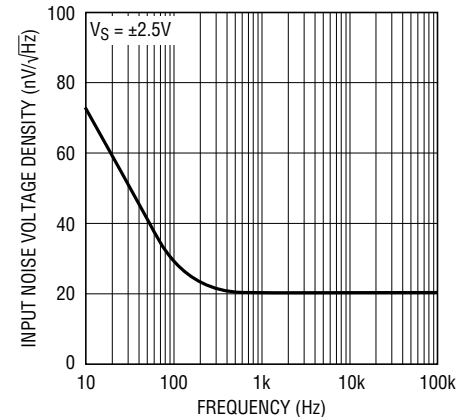

1797 G09

TYPICAL PERFORMANCE CHARACTERISTICS

Input Noise Current Density vs Frequency

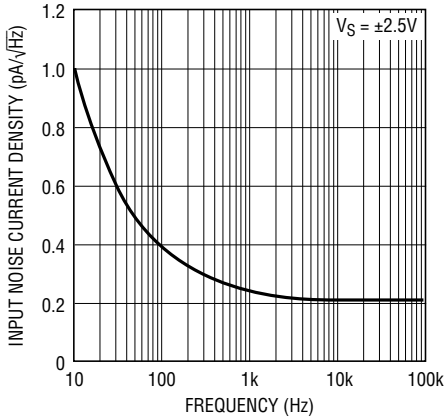

1797 G10

Gain and Phase Shift vs Frequency

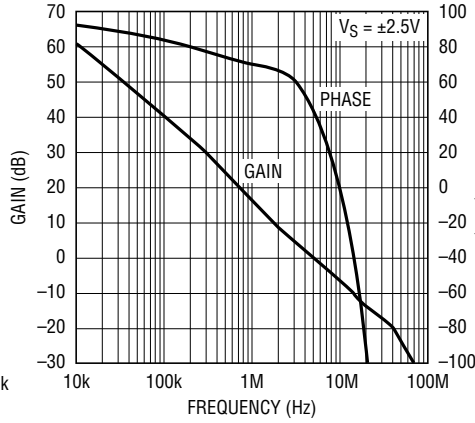

1797 G11

Gain Bandwidth Product vs Temperature

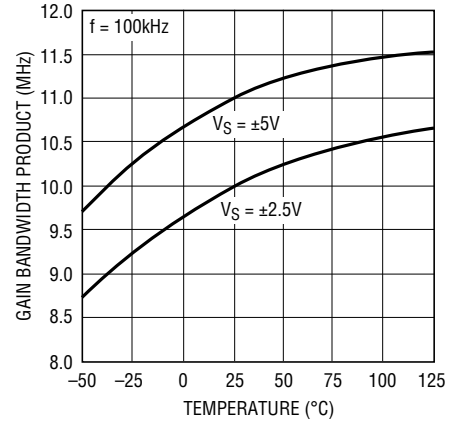

1797 G12

Slew Rate vs Temperature

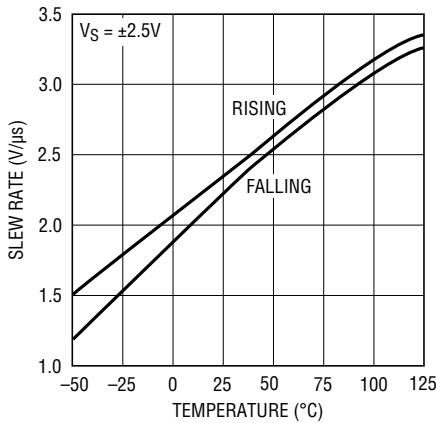

1797 G13

Gain Bandwidth Product and Phase Margin vs Supply Voltage

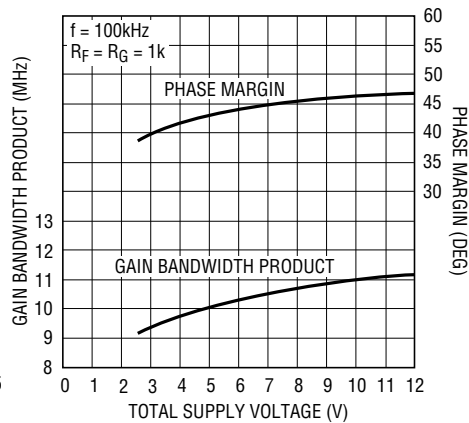

1797 G14

Gain Bandwidth Product and Phase Margin vs R<sub>F</sub> and R<sub>G</sub>

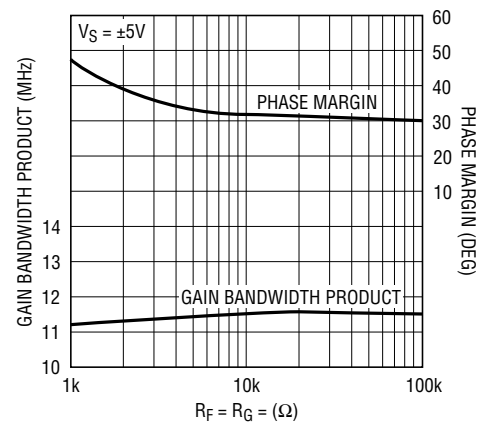

1797 G15

PSRR vs Frequency

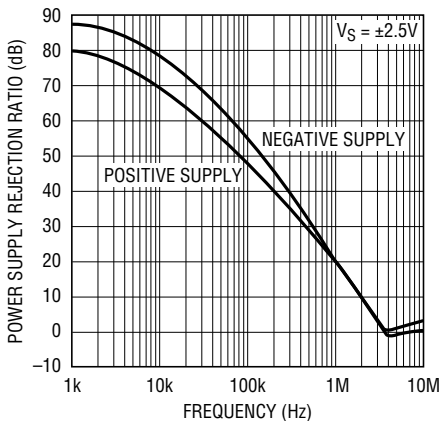

1797 G16

CMRR vs Frequency

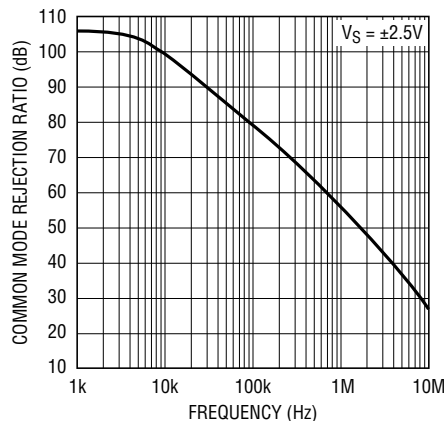

1797 G17

Output Impedance vs Frequency

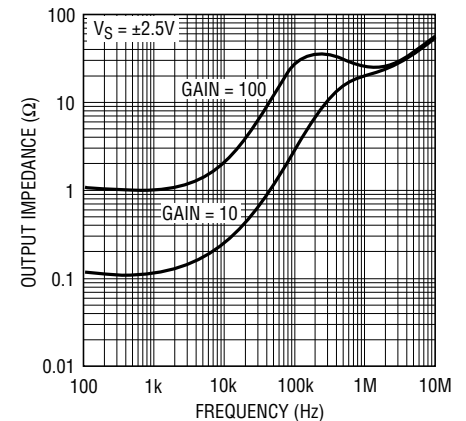

1797 G18

# TYPICAL PERFORMANCE CHARACTERISTICS

**Open-Loop Gain**

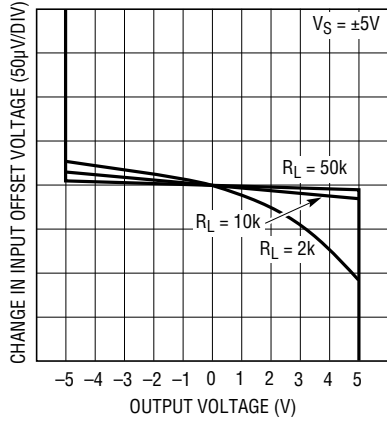

1797 G19

**Settling Time to 0.1% vs Output Step**

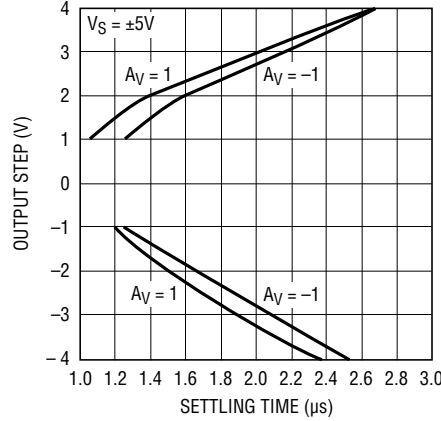

1797 G20

**Capacitive Load Handling Overshoot vs Capacitive Load**

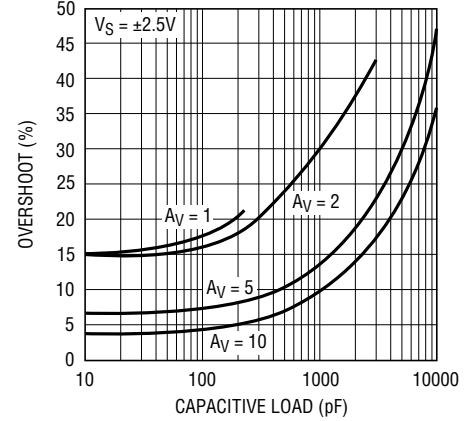

1797 G21

**Undistorted Output Swing vs Frequency**

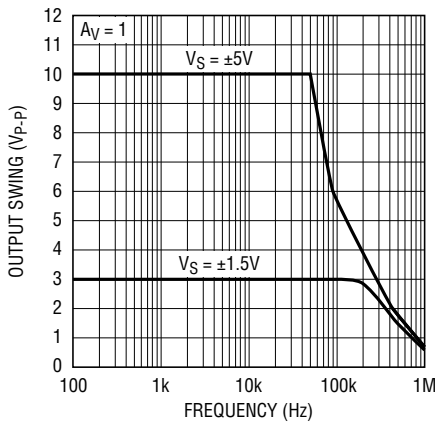

1797 G22

**Total Harmonic Distortion + Noise vs Frequency**

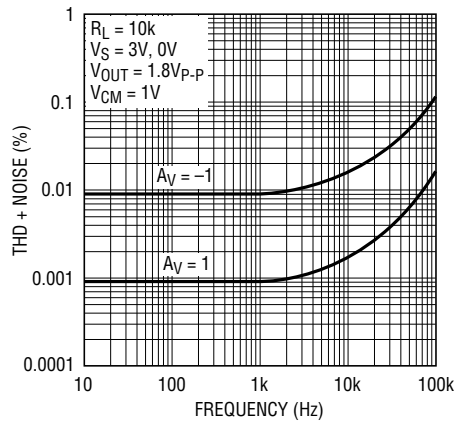

1797 G23

**Total Harmonic Distortion + Noise vs Load Resistance**

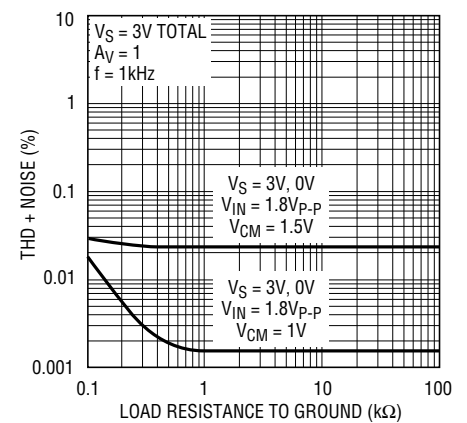

1797 G24

**Total Harmonic Distortion + Noise vs Output Voltage Amplitude**

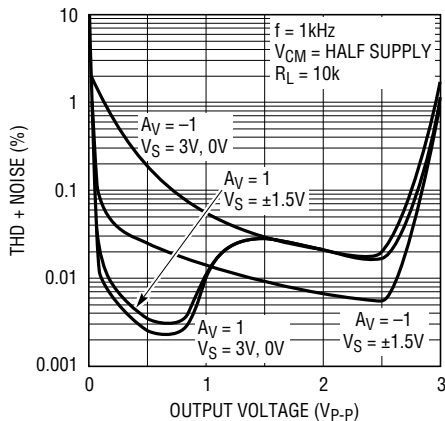

1797 G25

**Large-Signal Response**

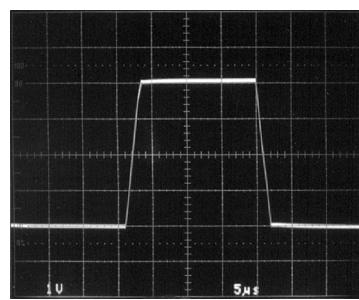

1797 G26

$V_S = \pm 2.5V$   
 $A_V = 1$

**Small-Signal Response**

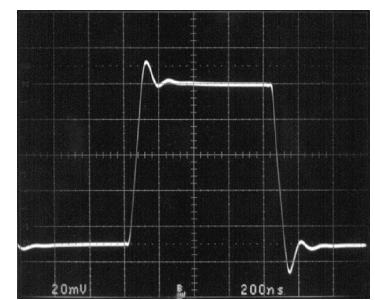

1797 G27

$V_S = \pm 2.5V$   
 $A_V = 1$   
 $R_L = 10k$

## APPLICATIONS INFORMATION

### Supply Voltage

The positive supply pin of the LT1797 should be bypassed with a small capacitor (about 0.1 $\mu$ F) within an inch of the pin. When driving heavy loads an additional 4.7 $\mu$ F electrolytic capacitor should be used. When using split supplies the same is true for the negative supply pin.

### Inputs

The LT1797 is fully functional for an input signal range from the negative supply to the positive supply. Figure 1 shows a simplified schematic of the amplifier. The input stage consists of two differential amplifiers, a PNP stage Q3/Q4 and an NPN stage Q1/Q2 that are active over different ranges of input common mode voltage. The PNP differential pair is active for input common mode voltages  $V_{CM}$  between the negative supply to approximately 1.3V below the positive supply. As  $V_{CM}$  moves closer toward the positive supply, the transistor QB1 will steer the tail current I1 to the current mirror Q5/Q6, activating the NPN differential pair and the PNP pair becomes inactive for the rest of the input common mode range up to the positive supply.

The input offset voltage and the input bias current are dependent on which input stage is active. The input offset voltage is trimmed on a single 5V supply with the common mode at 1/2 supply and is typically 1mV with the PNP stage active. The input offset of the NPN stage is untrimmed and is typically 1.5mV. The input bias current polarity depends on the input common mode voltage. When the PNP differential pair is active, the input bias currents flow out of the input pins. They flow in the opposite direction when the NPN input stage is active. The offset error due to the input bias currents can be minimized by equalizing the noninverting and inverting source impedance.

The input stage of the LT1797 incorporates phase reversal protection to prevent false outputs from occurring when the inputs are driven up to 5V beyond the rails. Protective resistors are included in the input leads so that current does not become excessive when the inputs are forced beyond the supplies or when a large differential signal is applied.

### Output

The output is configured with a pair of complementary common emitter stages Q19/Q20, which enable the output to swing from rail-to-rail. The output voltage swing of the LT1797 is affected by input overdrive as shown in the Typical Performance Characteristics. When monitoring input voltages within 50mV of  $V^+$  or within 8mV of  $V^-$ , some gain should be taken to keep the output from clipping. The output of the LT1797 can deliver large load currents; the short-circuit current limit is typically 50mA at  $\pm 5V$ . Take care to keep the junction temperature of the IC below the absolute maximum rating of 150°C. The output of the amplifier has reverse biased diodes to each supply. If the output is forced beyond either supply, unlimited current will flow through these diodes.

The LT1797 can drive capacitive loads up to 200pF on a single 5V supply in a unity gain configuration. When there is a need to drive larger capacitive loads, a resistor of a couple hundred ohms should be connected between the output and the capacitive load. The feedback should still be taken from the output so that the resistor isolates the capacitive load to ensure stability. The low input bias current of the LT1797 makes it possible to use high value feedback resistors to set the gain. However, care must be taken to insure that the pole formed by the feedback resistors and the total capacitance at the inverting input does not degrade stability.



## APPLICATIONS INFORMATION

### Distortion

There are two main contributors to distortion in op amps: output crossover distortion as the output transitions from sourcing to sinking current and distortion caused by non-linear common mode rejection. If the op amp is operating in the inverting mode, there is no common mode induced distortion. If the op amp is operating in the PNP input stage (input is not within 1.3V of  $V^+$ ), the CMRR is very good,

typically 96dB. When the LT1797 switches between input stages there is significant nonlinearity in the CMRR. Lower load resistance increases the output crossover distortion, but has no effect on the input stage transition distortion. For lowest distortion the LT1797 should be operated single supply, with the output always sourcing current and with the input voltage swing between ground and  $(V^+ - 1.3V)$ . See the Typical Performance Characteristic curves.

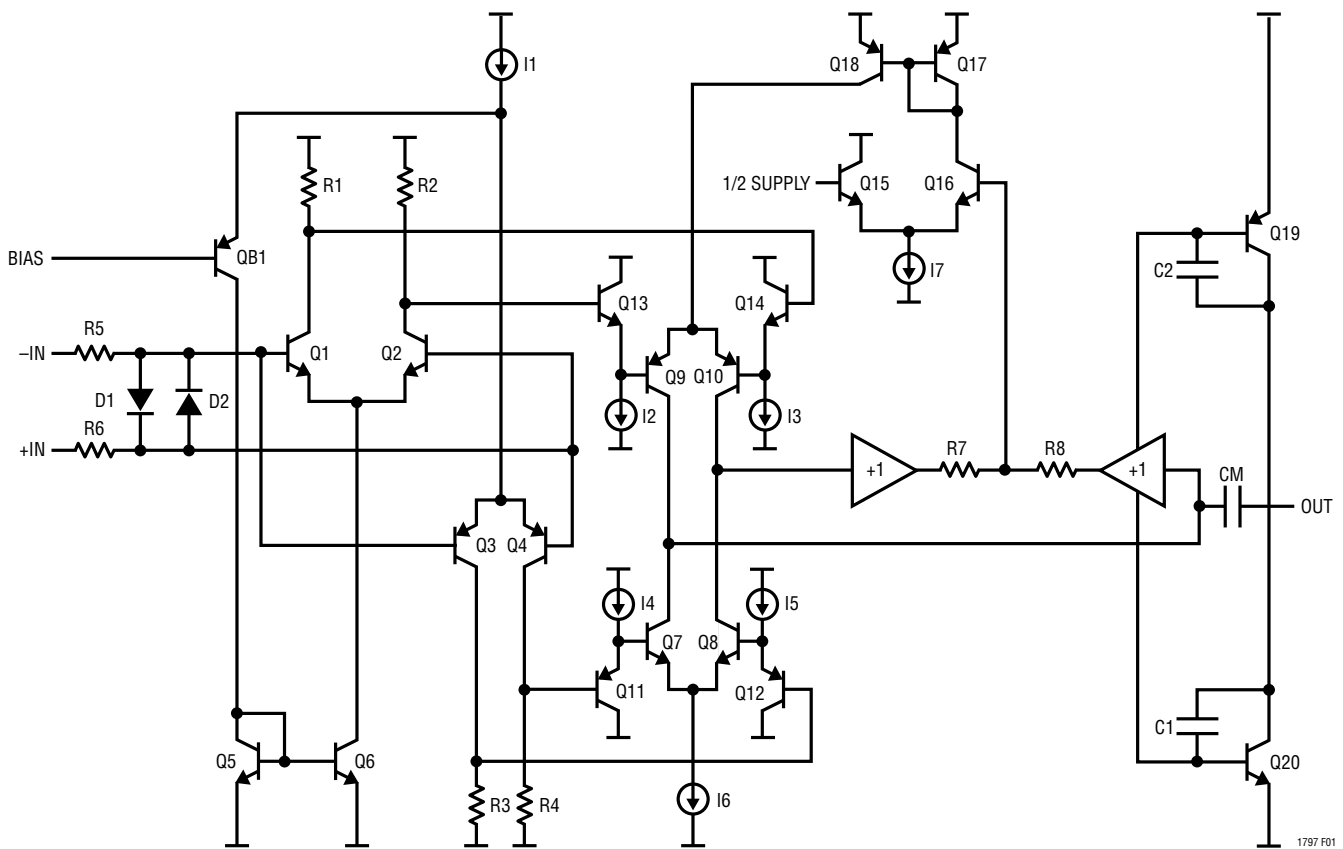
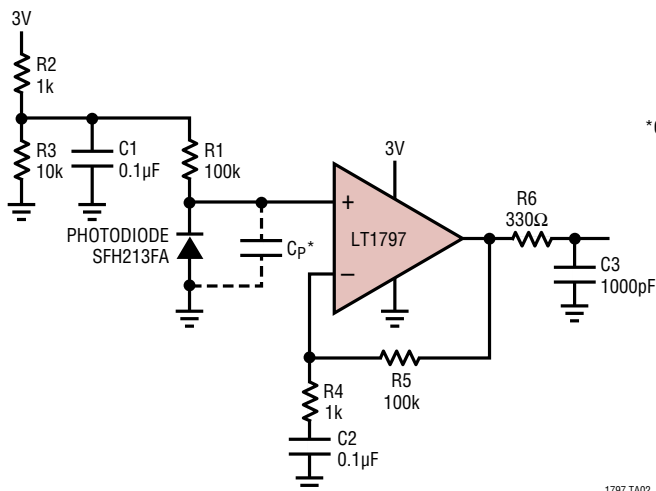

Figure 1. Simplified Schematic

## TYPICAL APPLICATIONS

### Single Supply Hi-Gain 80kHz Photodiode Amplifier



\* $C_p$  = SUM OF PHOTODIODE CAPACITANCE, PARASITIC LAYOUT CAPACITANCE AND LT1797 INPUT CAPACITANCE  $\cong 10\text{pF}$ .

TRANSIMPEDANCE GAIN:  $A_z = 10\text{M}\Omega$ .

R6, C3 LIMIT THE NOISE BANDWIDTH TO 500kHz.

OUTPUT NOISE  $\cong 1.8\text{mV}_{\text{RMS}}$ .

R1,  $C_p$  AND LT1797 GBW SET UPPER LIMIT ON BANDWIDTH.

R4, C2 SET LOWER 1.6kHz LIMIT ON GAIN OF 101.

1797 TA02

**TYPICAL APPLICATIONS**

**Ultralow Noise, ±5V Supply, Rail-to-Rail Output Amplifier**

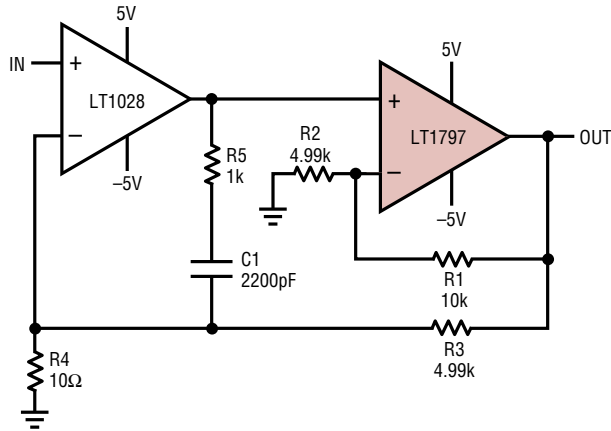

TOTAL INPUT VOLTAGE NOISE  $\cong 0.94\text{nV}/\sqrt{\text{Hz}}$   
(INCLUDING 10Ω RESISTOR)

BANDWIDTH  $\cong 40\text{kHz}$

$A_v = 500$

1797 TA03

# PACKAGE DESCRIPTION

Please refer to <http://www.linear.com/product/LT1797#packaging> for the most recent package drawings.

## S5 Package 5-Lead Plastic TSOT-23 (Reference LTC DWG # 05-08-1635)

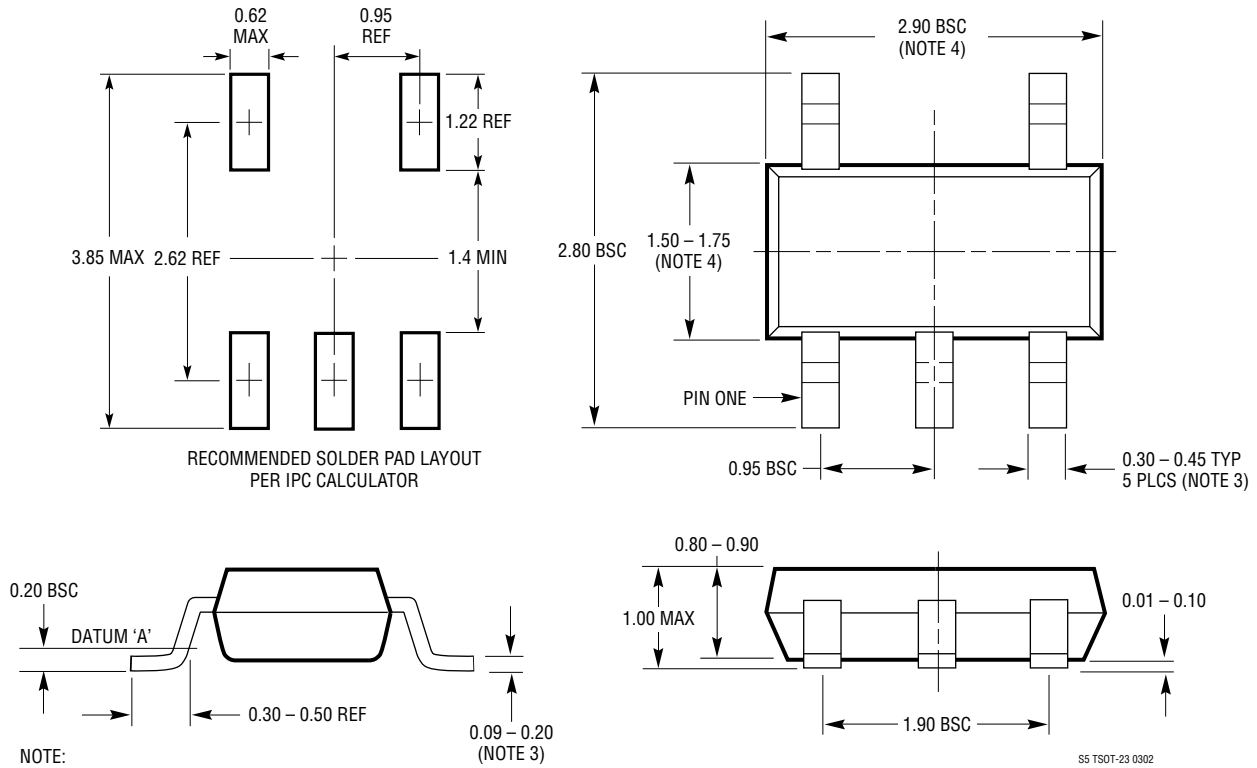

- NOTE:
1. DIMENSIONS ARE IN MILLIMETERS
  2. DRAWING NOT TO SCALE
  3. DIMENSIONS ARE INCLUSIVE OF PLATING
  4. DIMENSIONS ARE EXCLUSIVE OF MOLD FLASH AND METAL BURR
  5. MOLD FLASH SHALL NOT EXCEED 0.254mm
  6. JEDEC PACKAGE REFERENCE IS MO-193

S5 TSOT-23 0302

**REVISION HISTORY** (Revision history begins at Rev B)

REV	DATE	DESCRIPTION	PAGE NUMBER
B	6/10	Updated the last Feature.	1
		Updated the package description in the Pin Configuration section.	2
		Updated $V_{OH}$ in the Electrical Characteristics section.	3
		Replaced the package drawing in the Package Description section.	12
C	7/17	Corrected Simplified Schematic	9

## TYPICAL APPLICATION

### 1MHz Photodiode Transimpedance Amplifier

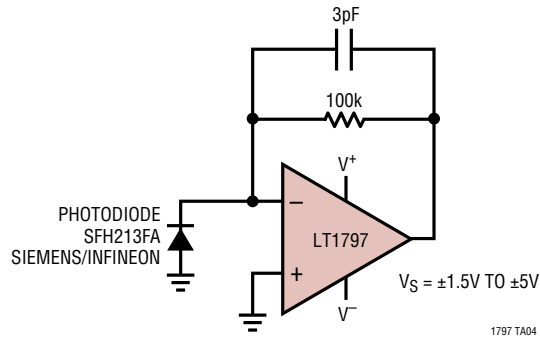

### Response of Photodiode Amplifier

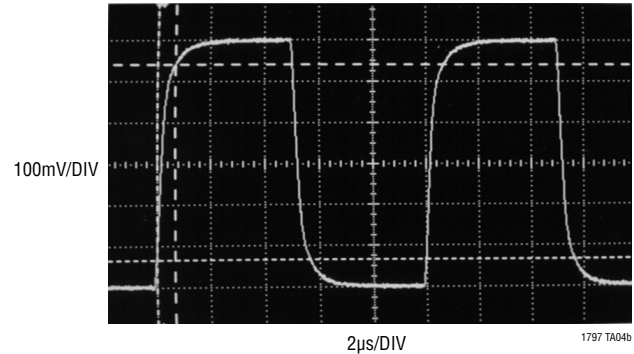

### Rise Time vs Supply Voltage (600mV Output Step)

Supply Voltage	10% to 90% Rise Time
±1.5V	830ns
±2.5V	800ns
±5V	700ns

## RELATED PARTS

PART NUMBER	DESCRIPTION	COMMENTS
<a href="#">LT1630/LT1631</a>	Dual/Quad 30MHz, 10V/µs Rail-to-Rail Input and Output Op Amps	High DC Accuracy, 525µV $V_{OS(MAX)}$ , 70mA Output Current, Max Supply Current 4.4mA per Amp
<a href="#">LT1638/LT1639</a>	Dual/Quad 1.2MHz, 0.4V/µs, Over-The-Top™ Micropower Rail-to-Rail Input and Output Op Amps	170µA Supply Current, Single Supply Input Range -0.4V to 44V, Rail-to-Rail Input and Output
<a href="#">LT1783</a>	Micropower Over-The-Top SOT-23 Rail-to-Rail Input and Output Op Amp	SOT-23 Package, Micropower 220µA per Amplifier, Rail-to-Rail Input and Output, 1.2MHz Gain Bandwidth
<a href="#">LT1880</a>	SOT-23 Rail-to-Rail Output, Picoamp Input Current Precision Op Amp	150µV Maximum Offset Voltage, 900pA Maximum Bias Current, 1.1MHz Gain Bandwidth, -40°C to 85°C Temperature Range



Компания «ЭлектроПласт» предлагает заключение долгосрочных отношений при поставках импортных электронных компонентов на взаимовыгодных условиях!

Наши преимущества:

- Оперативные поставки широкого спектра электронных компонентов отечественного и импортного производства напрямую от производителей и с крупнейших мировых складов;
- Поставка более 17-ти миллионов наименований электронных компонентов;
- Поставка сложных, дефицитных, либо снятых с производства позиций;
- Оперативные сроки поставки под заказ (от 5 рабочих дней);
- Экспресс доставка в любую точку России;
- Техническая поддержка проекта, помощь в подборе аналогов, поставка прототипов;
- Система менеджмента качества сертифицирована по Международному стандарту ISO 9001;
- Лицензия ФСБ на осуществление работ с использованием сведений, составляющих государственную тайну;
- Поставка специализированных компонентов (Xilinx, Altera, Analog Devices, Intersil, Interpoint, Microsemi, Aeroflex, Peregrine, Syfer, Eurofarad, Texas Instrument, Miteq, Cobham, E2V, MA-COM, Hittite, Mini-Circuits, General Dynamics и др.);

Помимо этого, одним из направлений компании «ЭлектроПласт» является направление «Источники питания». Мы предлагаем Вам помощь Конструкторского отдела:

- Подбор оптимального решения, техническое обоснование при выборе компонента;
- Подбор аналогов;
- Консультации по применению компонента;
- Поставка образцов и прототипов;
- Техническая поддержка проекта;
- Защита от снятия компонента с производства.



#### Как с нами связаться

**Телефон:** 8 (812) 309 58 32 (многоканальный)

**Факс:** 8 (812) 320-02-42

**Электронная почта:** [org@eplast1.ru](mailto:org@eplast1.ru)

**Адрес:** 198099, г. Санкт-Петербург, ул. Калинина, дом 2, корпус 4, литера А.