

## Insulated Gate Bipolar Transistor Ultralow $V_{CE(on)}$ , 250 A

**SOT-227**
**FEATURES**

- Standard: Optimized for minimum saturation voltage and low speed up to 5 kHz
- Lowest conduction losses available
- Fully isolated package (2500  $V_{AC}$ )
- Very low internal inductance (5 nH typical)
- Industry standard outline
- Designed and qualified for industrial level
- UL approved file E78996
- Material categorization: For definitions of compliance please see [www.vishay.com/doc?99912](http://www.vishay.com/doc?99912)

**RoHS  
COMPLIANT**

PRODUCT SUMMARY	
$V_{CES}$	600 V
$V_{CE(on)}$ (typical) at 200 A, 25 °C	1.33 V
$I_C$ at $T_C = 90$ °C <sup>(1)</sup>	250 A

**Note**

- <sup>(1)</sup> Maximum collector current admitted 100 A to do not exceed the maximum temperature of terminals

**BENEFITS**

- Designed for increased operating efficiency in power conversion: UPS, SMPS, TIG welding, induction heating
- Easy to assemble and parallel
- Direct mounting to heatsink
- Plug-in compatible with other SOT-227 packages

ABSOLUTE MAXIMUM RATINGS				
PARAMETER	SYMBOL	TEST CONDITIONS	MAX.	UNITS
Collector to emitter voltage	$V_{CES}$		600	V
Continuous collector current	$I_C$ <sup>(1)</sup>	$T_C = 25$ °C	400	A
		$T_C = 90$ °C	250	
Pulsed collector current	$I_{CM}$	Repetitive rating; $V_{GE} = 20$ V, pulse width limited by maximum junction temperature	400	
Clamped Inductive load current	$I_{LM}$	$V_{CC} = 80$ % ( $V_{CES}$ ), $V_{GE} = 20$ V, $L = 10$ $\mu$ H, $R_g = 2.0$ $\Omega$ ,	400	
Gate to emitter voltage	$V_{GE}$		$\pm 20$	V
Power dissipation	$P_D$	$T_C = 25$ °C	961	W
		$T_C = 90$ °C	462	
Isolation voltage	$V_{ISOL}$	Any terminal to case, $t = 1$ minute	2500	V

**Note**

- <sup>(1)</sup> Maximum collector current admitted 100 A to do not exceed the maximum temperature of terminals

THERMAL AND MECHANICAL SPECIFICATIONS					
PARAMETER	SYMBOL	MIN.	TYP.	MAX.	UNITS
Maximum junction and storage temperature	$T_J, T_{STG}$	- 40	-	150	°C
Junction to case thermal resistance	$R_{thJC}$	-	-	0.13	°C/W
Case to sink thermal resistance, flat, greased surface	$R_{thCS}$	-	0.1	-	
Mounting torque, on terminals and heatsink	T	-	-	1.3	Nm
Weight		-	30	-	g
Case style	SOT-227				



<b>ELECTRICAL SPECIFICATIONS</b> ( $T_J = 25\text{ }^\circ\text{C}$ unless otherwise noted)							
PARAMETER	SYMBOL	TEST CONDITIONS	MIN.	TYP.	MAX.	UNITS	
Collector to emitter breakdown voltage	$V_{(BR)CES}$	$V_{GE} = 0\text{ V}, I_C = 1\text{ mA}$	600	-	-	V	
Emitter to collector breakdown voltage	$V_{(BR)ECS}^{(1)}$	$V_{GE} = 0\text{ V}, I_C = 1.0\text{ A}$	18	-	-		
Collector to emitter voltage	$V_{CE(on)}$	$V_{GE} = 15\text{ V}$	$I_C = 100\text{ A}$	-	1.10		1.3
			$I_C = 200\text{ A}$	-	1.33		1.66
			$I_C = 100\text{ A}, T_J = 125\text{ }^\circ\text{C}$	-	1.02		-
			$I_C = 200\text{ A}, T_J = 125\text{ }^\circ\text{C}$	-	1.32		-
			$I_C = 100\text{ A}, T_J = 150\text{ }^\circ\text{C}$	-	1.02		-
			$I_C = 200\text{ A}, T_J = 150\text{ }^\circ\text{C}$	-	1.33		-
Gate threshold voltage	$V_{GE(th)}$	$V_{CE} = V_{GE}, I_C = 250\text{ }\mu\text{A}$	3.0	4.5	6.0		
		$V_{CE} = V_{GE}, I_C = 250\text{ }\mu\text{A}, T_J = 125\text{ }^\circ\text{C}$	-	3.1	-		
Temperature coefficient of threshold voltage	$\Delta V_{GE(th)}/\Delta T_J$	$V_{CE} = V_{GE}, I_C = 1\text{ mA}, 25\text{ }^\circ\text{C to } 125\text{ }^\circ\text{C}$	-	- 12	-	mV/ $^\circ\text{C}$	
Collector to emitter leakage current	$I_{CES}$	$V_{GE} = 0\text{ V}, V_{CE} = 600\text{ V}$	-	20	1000	$\mu\text{A}$	
		$V_{GE} = 0\text{ V}, V_{CE} = 600\text{ V}, T_J = 125\text{ }^\circ\text{C}$	-	0.2	-	mA	
		$V_{GE} = 0\text{ V}, V_{CE} = 600\text{ V}, T_J = 150\text{ }^\circ\text{C}$	-	0.6	10		
Gate to emitter leakage current	$I_{GES}$	$V_{GE} = \pm 20\text{ V}$	-	-	$\pm 250$	nA	

**Notes**

(1) Pulse width  $\leq 80\text{ }\mu\text{s}$ ; duty factor  $\leq 0.1\%$

<b>SWITCHING CHARACTERISTICS</b> ( $T_J = 25\text{ }^\circ\text{C}$ unless otherwise specified)								
PARAMETER	SYMBOL	TEST CONDITIONS	MIN.	TYP.	MAX.	UNITS		
Total gate charge (turn-on)	$Q_g$	$I_C = 100\text{ A}, V_{CC} = 600\text{ V}, V_{GE} = 15\text{ V}$	-	770	1200	nC		
Gate-to-emitter charge (turn-on)	$Q_{ge}$		-	100	150			
Gate-to-collector charge (turn-on)	$Q_{gc}$		-	260	380			
Turn-on switching loss	$E_{on}$	$T_J = 25\text{ }^\circ\text{C}$ $I_C = 100\text{ A}$ $V_{CC} = 480\text{ V}$ $V_{GE} = 15\text{ V}$ $R_g = 5.0\text{ }\Omega$ $L = 500\text{ }\mu\text{H}$	-	0.55	-	mJ		
Turn-off switching loss	$E_{off}$		-	25	-			
Total switching loss	$E_{tot}$		-	25.5	-			
Turn-on delay time	$t_{d(on)}$		$T_J = 125\text{ }^\circ\text{C}$ $I_C = 100\text{ A}$ $V_{CC} = 480\text{ V}$ $V_{GE} = 15\text{ V}$ $R_g = 5.0\text{ }\Omega$ $L = 500\text{ }\mu\text{H}$	-	267	-	ns	
Rise time	$t_r$			-	42	-		
Turn-off delay time	$t_{d(off)}$			-	310	-		
Fall time	$t_f$			-	450	-		
Turn-on switching loss	$E_{on}$			-	0.67	-		mJ
Turn-off switching loss	$E_{off}$			-	43.0	-		
Total switching loss	$E_{tot}$		-	43.7	-			
Turn-on delay time	$t_{d(on)}$	Energy losses include tail and diode recovery. Diode used 60APH06	-	275	-	ns		
Rise time	$t_r$		-	50	-			
Turn-off delay time	$t_{d(off)}$		-	350	-			
Fall time	$t_f$		-	700	-			
Internal emitter inductance	$L_E$	Between lead and center of die contact	-	5.0	-	nH		
Input capacitance	$C_{ies}$	$V_{GE} = 0\text{ V}, V_{CC} = 30\text{ V}, f = 1.0\text{ MHz}$	-	16 250	-	pF		
Output capacitance	$C_{oes}$		-	1040	-			
Reverse transfer capacitance	$C_{res}$		-	190	-			

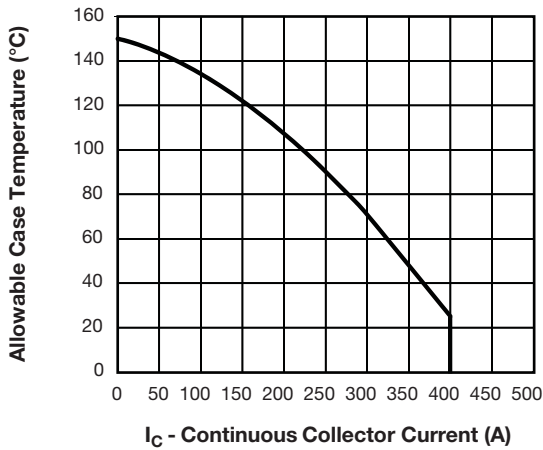

Fig. 1 - Maximum DC IGBT Collector Current vs. Case Temperature

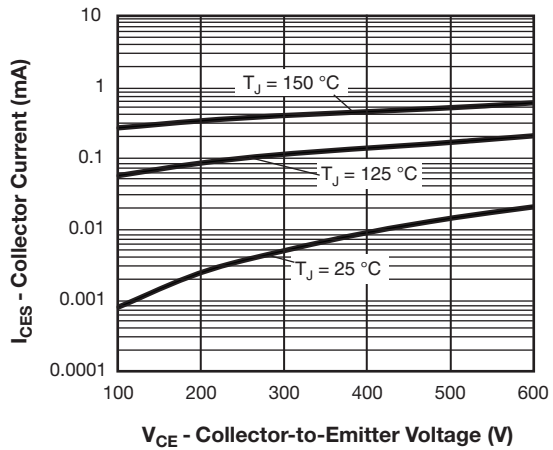

Fig. 4 - Typical IGBT Zero Gate Voltage Collector Current

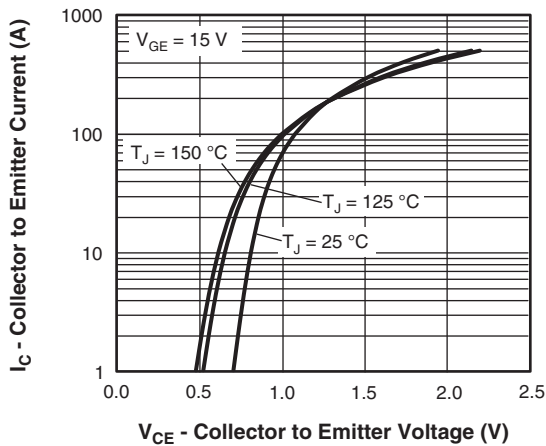

Fig. 2 - Typical Collector to Emitter Current Output Characteristics

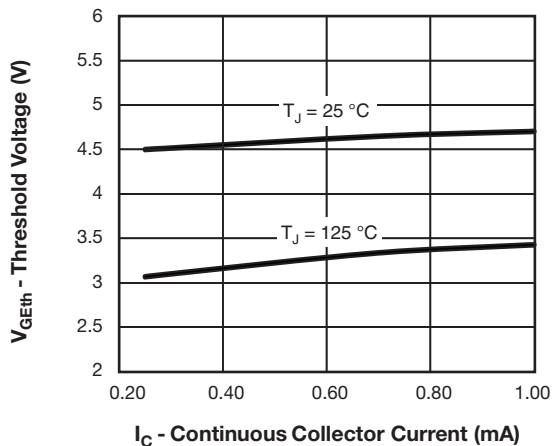

Fig. 5 - Typical IGBT Threshold Voltage

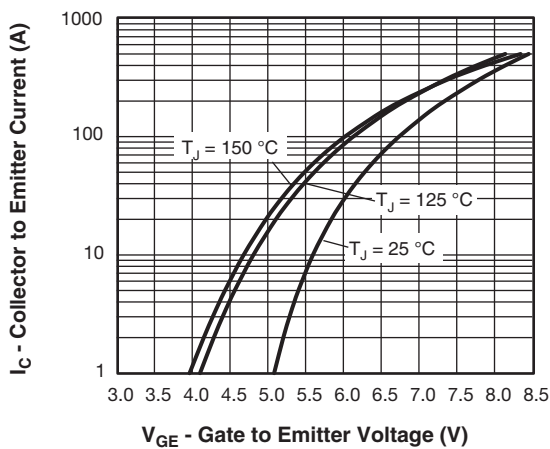

Fig. 3 - Typical IGBT Transfer Characteristics

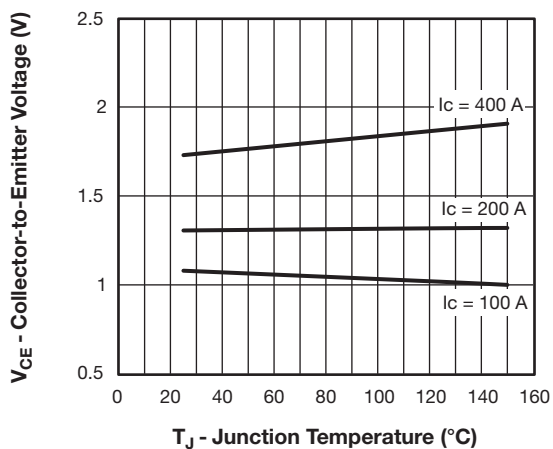

Fig. 6 - Typical IGBT Collector to Emitter Voltage vs. Junction Temperature,  $V_{GE} = 15\text{ V}$

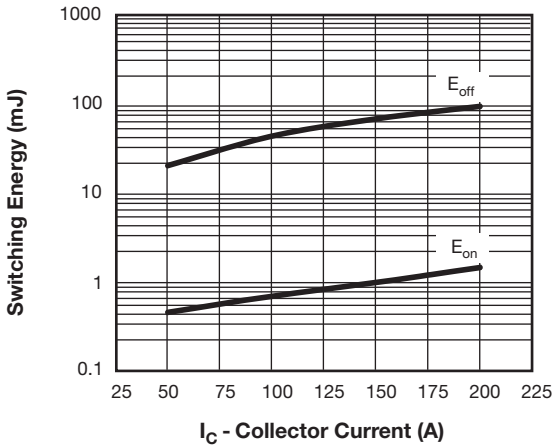

Fig. 7 - Typical IGBT Energy Losses vs.  $I_C$ ,  $T_J = 125^\circ\text{C}$ ,  $V_{CC} = 480\text{ V}$ ,  $V_{GE} = 15\text{ V}$ ,  $L = 500\ \mu\text{H}$ ,  $R_g = 5\ \Omega$ , Diode used: 60APH06

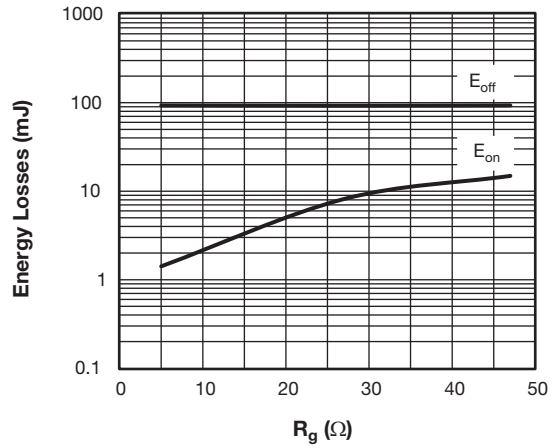

Fig. 9 - Typical IGBT Energy Losses vs.  $R_g$ ,  $T_J = 125^\circ\text{C}$ ,  $I_C = 200\text{ A}$ ,  $V_{CC} = 480\text{ V}$ ,  $V_{GE} = 15\text{ V}$ ,  $L = 500\ \mu\text{H}$ , Diode used: 60APH06

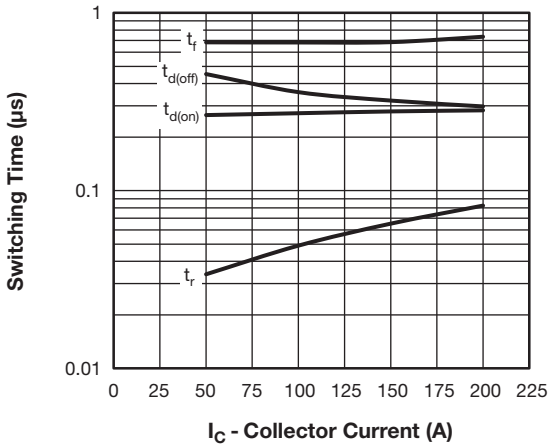

Fig. 8 - Typical IGBT Switching Time vs.  $I_C$ ,  $T_J = 125^\circ\text{C}$ ,  $V_{CC} = 480\text{ V}$ ,  $V_{GE} = 15\text{ V}$ ,  $L = 500\ \mu\text{H}$ ,  $R_g = 5\ \Omega$ , Diode used: 60APH06

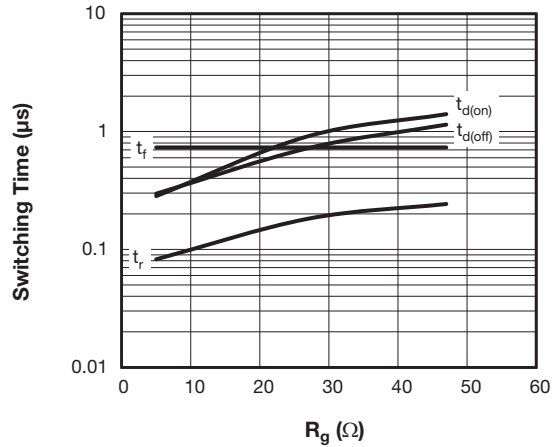

Fig. 10 - Typical IGBT Switching Time vs.  $R_g$ ,  $T_J = 125^\circ\text{C}$ ,  $I_C = 200\text{ A}$ ,  $V_{CC} = 480\text{ V}$ ,  $V_{GE} = 15\text{ V}$ ,  $L = 500\ \mu\text{H}$ , Diode used: 60APH06

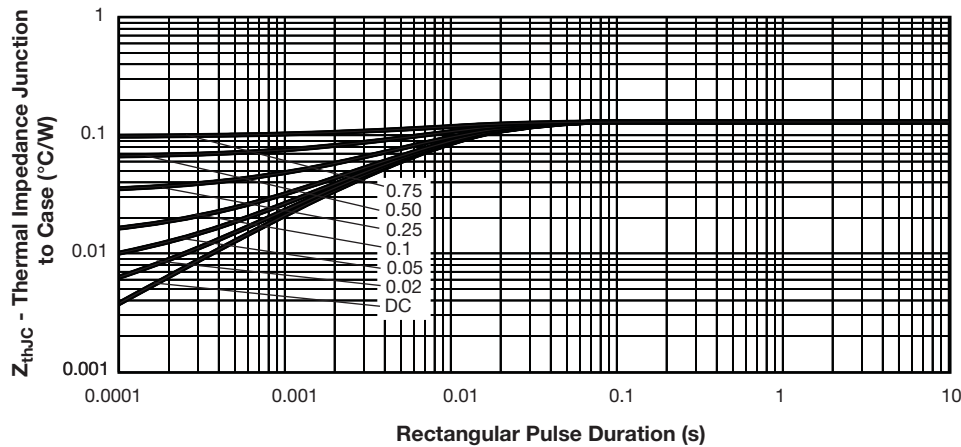

Fig. 11 - Maximum Thermal Impedance  $Z_{thJC}$  Characteristics

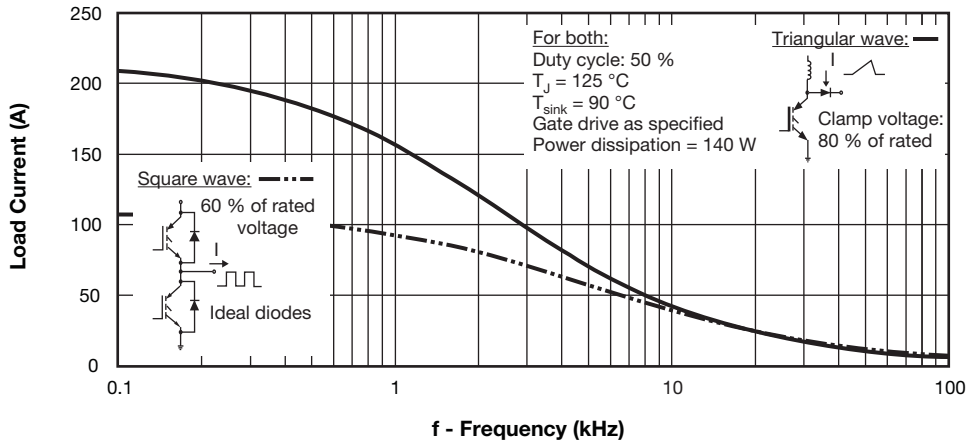

Fig. 12 - Typical Load Current vs. Frequency (Load Current =  $I_{RMS}$  of Fundamental)

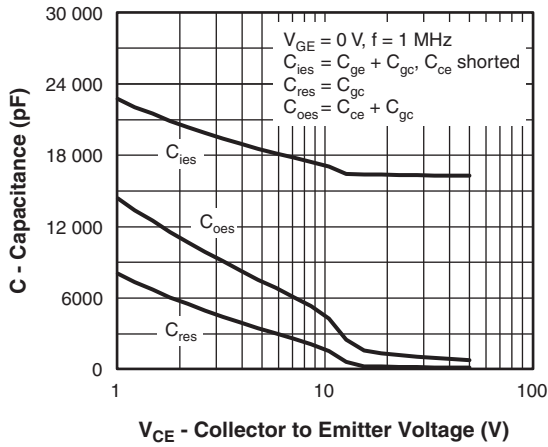

Fig. 13 - Typical Capacitance vs. Collector to Emitter Voltage

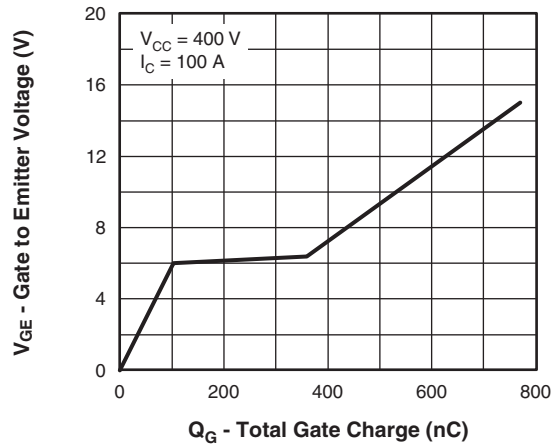

Fig. 14 - Typical Gate Charge vs. Gate to Emitter Voltage

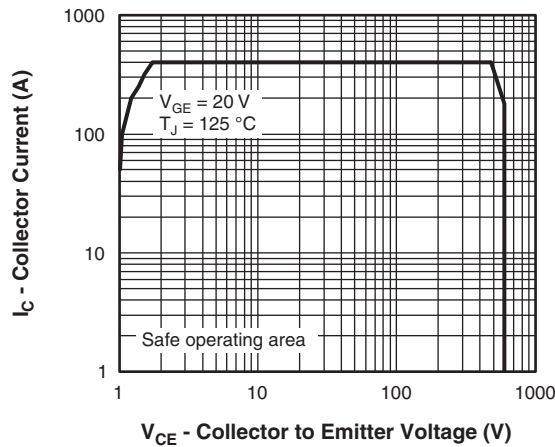
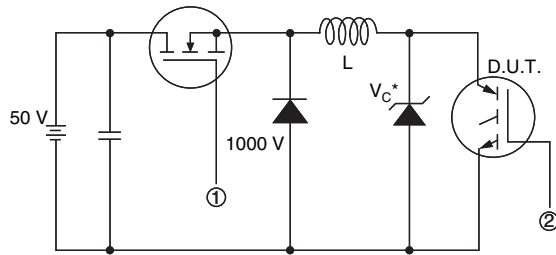

Fig. 15 - Turn-Off SOA



\* Driver same type as D.U.T.;  $V_C = 80\%$  of  $V_{CE}$  (max)

**Note:** Due to the 50 V power supply, pulse width and inductor will increase to obtain rated  $I_d$

Fig. 16a - Clamped Inductive Load Test Circuit

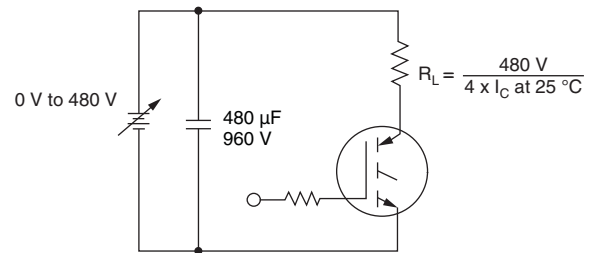
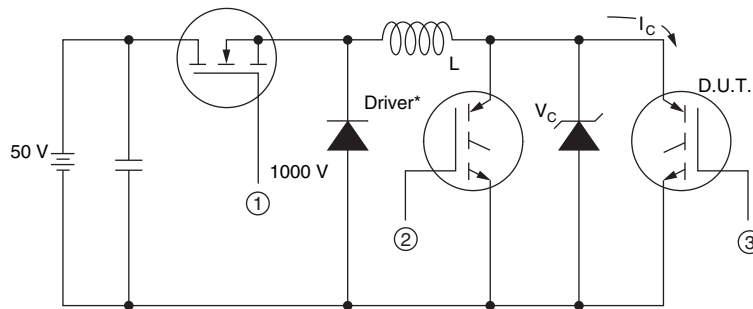

Fig. 16b - Pulsed Collector Current Test Circuit



\* Driver same type as D.U.T.,  $V_C = 480\text{ V}$

Fig. 17a - Switching Lost Test Circuit

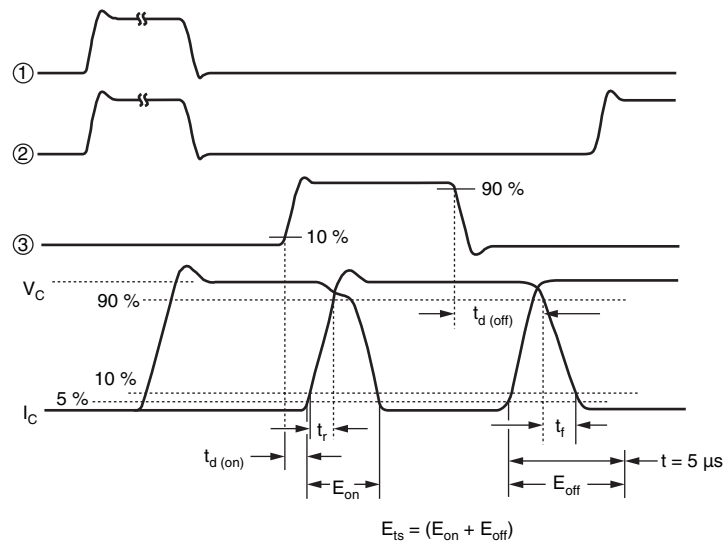

Fig. 17b - Switching Loss Waveforms

## ORDERING INFORMATION TABLE

Device code	<b>VS-</b>	<b>G</b>	<b>A</b>	<b>250</b>	<b>S</b>	<b>A</b>	<b>60</b>	<b>S</b>
	1	2	3	4	5	6	7	8

- 1** - Vishay Semiconductors product
- 2** - Insulated Gate Bipolar Transistor (IGBT)
- 3** - Generation 4, IGBT silicon
- 4** - Current rating (250 = 250 A)
- 5** - Circuit configuration (S = Single switch, without antiparallel diode)
- 6** - Package indicator (A = SOT-227)
- 7** - Voltage rating (60 = 600 V)
- 8** - Speed/type (S = Standard speed)

CIRCUIT CONFIGURATION		
CIRCUIT	CIRCUIT CONFIGURATION CODE	CIRCUIT DRAWING
Single switch, no antiparallel diode	S	 

LINKS TO RELATED DOCUMENTS	
Dimensions	<a href="http://www.vishay.com/doc?95423">www.vishay.com/doc?95423</a>
Packaging information	<a href="http://www.vishay.com/doc?95425">www.vishay.com/doc?95425</a>



### SOT-227 Generation II

**DIMENSIONS** in millimeters (inches)

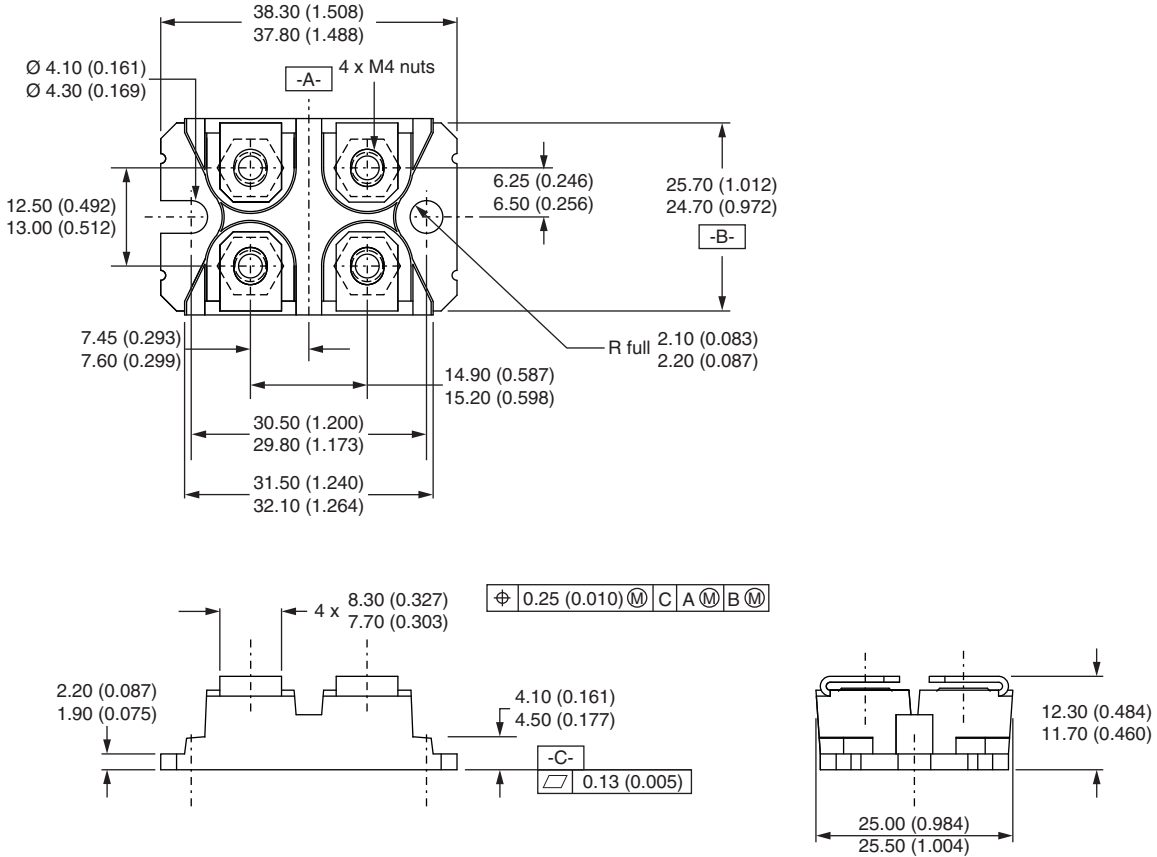

**Note**

- Controlling dimension: millimeter





## Disclaimer

ALL PRODUCT, PRODUCT SPECIFICATIONS AND DATA ARE SUBJECT TO CHANGE WITHOUT NOTICE TO IMPROVE RELIABILITY, FUNCTION OR DESIGN OR OTHERWISE.

Vishay Intertechnology, Inc., its affiliates, agents, and employees, and all persons acting on its or their behalf (collectively, "Vishay"), disclaim any and all liability for any errors, inaccuracies or incompleteness contained in any datasheet or in any other disclosure relating to any product.

Vishay makes no warranty, representation or guarantee regarding the suitability of the products for any particular purpose or the continuing production of any product. To the maximum extent permitted by applicable law, Vishay disclaims (i) any and all liability arising out of the application or use of any product, (ii) any and all liability, including without limitation special, consequential or incidental damages, and (iii) any and all implied warranties, including warranties of fitness for particular purpose, non-infringement and merchantability.

Statements regarding the suitability of products for certain types of applications are based on Vishay's knowledge of typical requirements that are often placed on Vishay products in generic applications. Such statements are not binding statements about the suitability of products for a particular application. It is the customer's responsibility to validate that a particular product with the properties described in the product specification is suitable for use in a particular application. Parameters provided in datasheets and/or specifications may vary in different applications and performance may vary over time. All operating parameters, including typical parameters, must be validated for each customer application by the customer's technical experts. Product specifications do not expand or otherwise modify Vishay's terms and conditions of purchase, including but not limited to the warranty expressed therein.

Except as expressly indicated in writing, Vishay products are not designed for use in medical, life-saving, or life-sustaining applications or for any other application in which the failure of the Vishay product could result in personal injury or death. Customers using or selling Vishay products not expressly indicated for use in such applications do so at their own risk and agree to fully indemnify and hold Vishay and its distributors harmless from and against any and all claims, liabilities, expenses and damages arising or resulting in connection with such use or sale, including attorneys fees, even if such claim alleges that Vishay or its distributor was negligent regarding the design or manufacture of the part. Please contact authorized Vishay personnel to obtain written terms and conditions regarding products designed for such applications.

No license, express or implied, by estoppel or otherwise, to any intellectual property rights is granted by this document or by any conduct of Vishay. Product names and markings noted herein may be trademarks of their respective owners.

## Material Category Policy

**Vishay Intertechnology, Inc. hereby certifies that all its products that are identified as RoHS-Compliant fulfill the definitions and restrictions defined under Directive 2011/65/EU of The European Parliament and of the Council of June 8, 2011 on the restriction of the use of certain hazardous substances in electrical and electronic equipment (EEE) - recast, unless otherwise specified as non-compliant.**

**Please note that some Vishay documentation may still make reference to RoHS Directive 2002/95/EC. We confirm that all the products identified as being compliant to Directive 2002/95/EC conform to Directive 2011/65/EU.**



Компания «ЭлектроПласт» предлагает заключение долгосрочных отношений при поставках импортных электронных компонентов на взаимовыгодных условиях!

Наши преимущества:

- Оперативные поставки широкого спектра электронных компонентов отечественного и импортного производства напрямую от производителей и с крупнейших мировых складов;
- Поставка более 17-ти миллионов наименований электронных компонентов;
- Поставка сложных, дефицитных, либо снятых с производства позиций;
- Оперативные сроки поставки под заказ (от 5 рабочих дней);
- Экспресс доставка в любую точку России;
- Техническая поддержка проекта, помощь в подборе аналогов, поставка прототипов;
- Система менеджмента качества сертифицирована по Международному стандарту ISO 9001;
- Лицензия ФСБ на осуществление работ с использованием сведений, составляющих государственную тайну;
- Поставка специализированных компонентов (Xilinx, Altera, Analog Devices, Intersil, Interpoint, Microsemi, Aeroflex, Peregrine, Syfer, Eurofarad, Texas Instrument, Miteq, Cobham, E2V, MA-COM, Hittite, Mini-Circuits, General Dynamics и др.);

Помимо этого, одним из направлений компании «ЭлектроПласт» является направление «Источники питания». Мы предлагаем Вам помощь Конструкторского отдела:

- Подбор оптимального решения, техническое обоснование при выборе компонента;
- Подбор аналогов;
- Консультации по применению компонента;
- Поставка образцов и прототипов;
- Техническая поддержка проекта;
- Защита от снятия компонента с производства.



#### Как с нами связаться

**Телефон:** 8 (812) 309 58 32 (многоканальный)

**Факс:** 8 (812) 320-02-42

**Электронная почта:** [org@eplast1.ru](mailto:org@eplast1.ru)

**Адрес:** 198099, г. Санкт-Петербург, ул. Калинина, дом 2, корпус 4, литера А.