

Trimmer Potentiometers



EU RoHS Compliant

- All the products in this catalog comply with EU RoHS.
- EU RoHS is "the European Directive 2011/65/EU on the Restriction of the Use of Certain Hazardous Substances in Electrical and Electronic Equipment."
- For more details, please refer to our website 'Murata's Approach for EU RoHS' (<http://www.murata.com/info/rohs.html>).

CONTENTS

| | | |
|---|-------|----|
| Part Numbering | _____ | 2 |
| Selection Guide of Trimmer Potentiometers | _____ | 3 |
| 1 SMD Open Type 2mm Size PVZ2/PVA2 Series | _____ | 4 |
| ● PVZ2/PVA2 Series Notice | _____ | 8 |
| 2 SMD Open Type 3mm Size PVZ3 Series | _____ | 10 |
| ● PVZ3 Series Notice | _____ | 14 |
| 3 SMD Sealed Type 3mm Size PVG3 Series | _____ | 16 |
| ● PVG3 Series Notice | _____ | 19 |
| 4 SMD Sealed Type 4mm Size PVM4 Series | _____ | 21 |
| ● PVM4 Series Notice | _____ | 23 |
| 5 SMD Sealed Type Multi-turn PVG5 Series | _____ | 26 |
| ● PVG5 Series Notice | _____ | 29 |
| 6 Lead Sealed Type Single-turn PV32 Series | _____ | 31 |
| ● PV32 Series Notice | _____ | 34 |
| 7 Lead Sealed Type Multi-turn PV12/PV37/PV36 Series | _____ | 36 |
| ● PV12/PV37/PV36 Series Notice | _____ | 43 |
| SMD Open Type (PVZ2/A2/Z3)/SMD Sealed Type (PVM4A_C01 Series) Specifications and Test Methods | _____ | 45 |
| SMD Sealed Type (PVG3/M4A_D01/G5)/Lead Sealed Type (PV32/12/37/36) Specifications and Test Methods | _____ | 46 |
| Packaging | _____ | 49 |
| Recommended Adjustment Tools/Qualified Standards | _____ | 52 |

• The RoHS compliance means that we judge from EU Directive 2011/65/EU the products do not contain lead, cadmium, mercury, hexavalent chromium, PBB and PBDE, except exemptions stated in EU Directive 2011/65/EU annex and impurities existing in the natural world.
 • This statement does not insure the compliance of any of the listed parts with any laws or legal imperatives developed by any EU members individually with regards to the RoHS Directive.



1

2

3

4

5

6

7

● Part Numbering

Trimmer Potentiometers

(Part Number)

| | | | | | |
|----|----|---|-----|-----|-----|
| PV | Z3 | A | 103 | C01 | R00 |
| ① | ② | ③ | ④ | ⑤ | ⑥ |

① Product ID

| Product ID | |
|------------|------------------------|
| PV | Trimmer Potentiometers |

② Series

③ Adjustment Direction /Lead Type

| Code | Series | Code | Adjustment Direction/ Lead Type |
|------|---|------|------------------------------------|
| Z2 | SMD Open 2mm Size Carbon Resistive Element | A | Top |
| | | R | Rear |
| A2 | SMD Open 2mm Size | A | Top |
| Z3 | SMD Open 3mm Size Carbon Resistive Element | A | Top |
| | | G | Top |
| | | H | Top |
| G3 | SMD Sealed 3mm Size | K | Rear |
| | | A | Top, J-hook |
| M4 | SMD Sealed 4mm Size | G | Top, Gull-wing |
| | | A | Top |
| G5 | SMD Sealed 5mm Square 11 turns | A | Top |
| | | H | Side |
| 32 | Lead Sealed 6mm Round Single turn | H | Top, Triangle |
| | | N | Side, Triangle |
| 12 | Lead Sealed 7mm Round 4 turns | P | Top, Triangle |
| | | T | Side, Triangle |
| 36 | Lead Sealed 10mm Square 25 turns | W | Top, Inline |
| | | X | Side, Inline |
| 37 | Lead Sealed 6mm Square 12 turns | W | Top, Triangle |
| | | X | Side, Triangle |

④ Total Resistance

Expressed by three figures. The unit is ohm. The first and second figures are significant digits, and the third figure expresses the number of zeros that follow the two figures.

| Ex.) | Code | Total Resistance |
|------|------|------------------|
| | 100 | 10Ω |
| | 102 | 1000Ω |
| | 104 | 100000Ω (=100kΩ) |

⑤ Individual Specification

| Series | Code | Individual Specification Code |
|--------------------|------|---|
| PVA2 | A01 | Standard Type |
| PVZ2 | C04 | Standard Type (High-heat Resistance Type/Ultra-thin Type) |
| | | C01 |
| PVZ3 | F01 | High Characteristic Carbon Type (only PVZ3G) |
| | E01 | High-heat Resistance Type (for Rear Adjustment) |
| PVM4 | C01 | Standard Type |
| | D01 | High-reliability Type |
| PV32/PV12 | A01 | Standard Type |
| PVG3/ PV36/PV37 | C01 | Standard Type |
| PVG5 | C03 | Standard Type |

⑥ Packaging

| Code | Packaging |
|------|-----------|
| B00 | Bulk |
| R00 | Reel |

Selection Guide of Trimmer Potentiometers



Trimmer Potentiometers



SMD Open Type 2mm Size PVZ2/PVA2 Series

PVZ2 Series

■ Features

1. Ultra-small and thin external dimensions of 2.1(W)x2.7(L)x0.85 max. (T)mm.
(Top adjustment type: PVZ2A_C04 Series)
2. Ultra-small and thin external dimensions of 2.1(W)x4.8(L)x0.9 max. (T)mm.
(Rear adjustment type: PVZ2R_C04 Series)
Compact PCB design is possible by smaller adjustment hole (3.0mm dia.) due to short wing length (4.8mm).
3. Au plated termination achieves a high-density PCB mounting.
4. Cross-shaped driver slot allows for in-process automatic adjustment and it provides superior adjustability.
5. Two-piece parts construction achieves low cost and excellent quality.
6. Special resin substrate allows high peak temperature for reflow soldering (PVZ2_Cxx Series).
7. PVZ2 series complies with RoHS directive.

■ Applications

- | | |
|-------------------|-------------------------|
| 1. Pick-up module | 6. DVC |
| 2. LCD | 7. Digital camera |
| 3. Cellular phone | 8. Portable audio, etc. |
| 4. PHS | 9. RKE |
| 5. Pager | 10. E-Book |



| Part Number | Power Rating (W) | Number of Turns (Effective Rotation Angle) | Mechanical Rotation Angle | Total Resistance Value | TCR (ppm/°C) |
|-------------|------------------|--|---------------------------|------------------------|--------------|
| PVZ2□471C04 | 0.05(50°C) | 1(240°±10°) | Endless | 470ohm±30% | ±500 |
| PVZ2□102C04 | 0.05(50°C) | 1(240°±10°) | Endless | 1k ohm±30% | ±500 |
| PVZ2□222C04 | 0.05(50°C) | 1(240°±10°) | Endless | 2.2k ohm±30% | ±500 |
| PVZ2□472C04 | 0.05(50°C) | 1(240°±10°) | Endless | 4.7k ohm±30% | ±500 |
| PVZ2□103C04 | 0.05(50°C) | 1(240°±10°) | Endless | 10k ohm±30% | ±500 |
| PVZ2□223C04 | 0.05(50°C) | 1(240°±10°) | Endless | 22k ohm±30% | ±500 |
| PVZ2□473C04 | 0.05(50°C) | 1(240°±10°) | Endless | 47k ohm±30% | ±500 |
| PVZ2□104C04 | 0.05(50°C) | 1(240°±10°) | Endless | 100k ohm±30% | ±500 |
| PVZ2□224C04 | 0.05(50°C) | 1(240°±10°) | Endless | 220k ohm±30% | ±500 |
| PVZ2□474C04 | 0.05(50°C) | 1(240°±10°) | Endless | 470k ohm±30% | ±500 |
| PVZ2□105C04 | 0.05(50°C) | 1(240°±10°) | Endless | 1M ohm±30% | ±500 |

Operating Temperature Range: -25 to 85 °C
 Soldering Method: Reflow/Soldering Iron

■ Construction

PVZ2A



■ Standard Land Pattern

PVZ2A



(Tolerance : ±0.1 in mm)

■ Construction

PVZ2R



■ Standard Land Pattern

PVZ2R



(Tolerance : ±0.1 in mm)

■ Characteristics

| | |
|---------------------------|--|
| Humidity Exposure | Res. Change: +10, -2% |
| High Temperature Exposure | Res. Change: $R \leq 50\text{kohm} \cdots +2, -10\%$ $50\text{kohm} < R \cdots +2, -15\%$ |
| Humidity Load Life | Res. Change: ±10% |
| Load Life | Res. Change: $R \leq 50\text{kohm} \cdots +2, -10\%$ $50\text{kohm} < R \cdots +2, -15\%$ |
| Temperature Cycle | Res. Change: ±5% |
| Rotational Life | Res. Change: ±10% (10 cycles) |

PVA2 Series

■ Features

1. Ultra-small and thin external dimensions of 2.2(W)x2.75(L)x0.90 max.(T)mm.
2. For the terminal attachment method of construction that uses neither solder nor adhesives, good solderability and terminal attachment intensity are realized.
3. Because of multi-contact wiper structure, PVA2 has a stable characteristics (low noise).
4. PVA2 series does not use a solder, flux or cleaning solvent, so they are environmentally friendly products.
5. Heat resistance performance enables high temperature peak reflow soldering.
6. PVA2 series complies with RoHS directive.

■ Applications

1. Thin-model optical pick-up module
2. LCD module
3. Optical communication module
4. Small sensor module
5. Digital camera
6. Small telecommunications equipment, etc.
7. E-Book



| Part Number | Power Rating (W) | Number of Turns (Effective Rotation Angle) | Mechanical Rotation Angle | Total Resistance Value | TCR (ppm/°C) |
|-------------|------------------|--|---------------------------|------------------------|--------------|
| PVA2A101A01 | 0.1(70°C) | 1(260°±10°) | Endless | 100ohm±25% | ±250 |
| PVA2A221A01 | 0.1(70°C) | 1(260°±10°) | Endless | 220ohm±25% | ±250 |
| PVA2A471A01 | 0.1(70°C) | 1(260°±10°) | Endless | 470ohm±25% | ±250 |
| PVA2A102A01 | 0.1(70°C) | 1(260°±10°) | Endless | 1k ohm±25% | ±250 |
| PVA2A222A01 | 0.1(70°C) | 1(260°±10°) | Endless | 2.2k ohm±25% | ±250 |
| PVA2A472A01 | 0.1(70°C) | 1(260°±10°) | Endless | 4.7k ohm±25% | ±250 |
| PVA2A103A01 | 0.1(70°C) | 1(260°±10°) | Endless | 10k ohm±25% | ±250 |
| PVA2A223A01 | 0.1(70°C) | 1(260°±10°) | Endless | 22k ohm±25% | ±250 |
| PVA2A473A01 | 0.1(70°C) | 1(260°±10°) | Endless | 47k ohm±25% | ±250 |
| PVA2A104A01 | 0.1(70°C) | 1(260°±10°) | Endless | 100k ohm±25% | ±250 |
| PVA2A224A01 | 0.1(70°C) | 1(260°±10°) | Endless | 220k ohm±25% | ±250 |
| PVA2A474A01 | 0.1(70°C) | 1(260°±10°) | Endless | 470k ohm±25% | ±250 |
| PVA2A105A01 | 0.1(70°C) | 1(260°±10°) | Endless | 1M ohm±25% | ±250 |
| PVA2A225A01 | 0.1(70°C) | 1(260°±10°) | Endless | 2.2M ohm±25% | ±250 |

Operating Temperature Range: -55 to 125 °C
 Soldering Method: Reflow/Soldering Iron

■ Construction



■ Standard Land Pattern



(Tolerance : ±0.1 in mm)

■ Characteristics

| | |
|---------------------------|-------------------------------|
| Humidity Exposure | Res. Change: ±3% |
| High Temperature Exposure | Res. Change: ±3% |
| Humidity Load Life | Res. Change: ±3% |
| Load Life | Res. Change: ±3% |
| Temperature Cycle | Res. Change: ±3% |
| Rotational Life | Res. Change: ±10% (10 cycles) |

■ Notice (Operating and Storage Conditions)

1. Store in temperatures of -10 to +40°C and relative humidity of 30-85%.
2. Do not store in or near corrosive gases.
3. Use within six months after delivery.
4. Open the package just before using.
5. Do not store under direct sunlight.
6. If you use the trimmer potentiometer in an environment other than listed at right, please consult with a Murata factory representative prior to using.

The trimmer potentiometer should not be used under the following environmental conditions:

- (1) Corrosive gaseous atmosphere
(Ex. Chlorine gas, Hydrogen sulfide gas, Ammonia gas, Sulfuric acid gas, Nitric oxide gas, etc.)
- (2) In liquid
(Ex. Oil, Medical liquid, Organic solvent, etc.)
- (3) Dusty/dirty atmosphere
- (4) Direct sunlight
- (5) Static voltage or electric/magnetic fields
- (6) Direct sea breeze
- (7) Other variations of the above

■ Notice (Rating)

1. When using with partial load (rheostat), minimize the power depending on the resistance value.
2. The maximum input voltage to a trimmer potentiometer should not exceed $(P \cdot R)^{1/2}$ or the maximum operating voltage, whichever is smaller.
3. If the trimmer potentiometer is used in DC and high humidity conditions, please connect wiper (#2) for plus and resistive element (#1 or #3) for minus.
(PVZ Series only)

■ Notice (Soldering and Mounting)

1. Soldering
 - (1) Reflow soldering method and soldering iron are available. This product cannot be soldered using the flow soldering method (dipping). If you use the flow soldering method, the trimmer potentiometer may not function.
 - (2) Use our standard land dimension. Excessive land area causes displacement due to the effect of the surface tension of the solder. Insufficient land area leads to insufficient soldering strength of the chip.
 - (3) Soldering conditions
Refer to the temperature profile.
If the soldering conditions are not suitable, e.g., excessive time and/or excessive temperature, the trimmer potentiometer may deviate from the specified characteristics.
 - (4) Apply the appropriate amount of solder paste.
The thickness of solder paste should be printed from 100 micro m to 150 micro m and the dimension of land pattern used should be Murata's standard land pattern at reflow soldering.
Insufficient amounts of solder can lead to insufficient soldering strength on PCB.
Excessive amounts of solder may cause bridging between the terminals.

- (5) The soldering iron should not come in contact with the case of the trimmer potentiometer. If such contact does occur, the trimmer potentiometer may be damaged.

2. Mounting

- (1) Do not apply excessive force, preferably 4.9N max. (Ref. 500gf) when the trimmer potentiometer is mounted to the PCB.
- (2) Do not warp and/or bend the PC board to protect trimmer potentiometer from breakage.
- (3) In chip placers, the recommended size of the cylindrical pick-up nozzle should be outer dimension 1.5-1.8mm dia. and inner dimension 1.3mm dia.

3. Cleaning

- (1) In case there is flux on the resistive element, clean sufficiently with cleaning solvents and completely remove all residual flux.
- (2) Isopropyl alcohol and ethyl alcohol are applicable solvents for cleaning. If you use any other types of solvents, please evaluate performance with your product.

Continued on the following page. 

PVZ2/PVA2 Series Notice

Continued from the preceding page.

■ Soldering Profile

● Reflow Soldering Profile

1. Soldering profile for lead free solder (96.5Sn/3.0Ag/0.5Cu)



| Series | Standard Profile | | | | | | Limit Profile | | | | | |
|--------|------------------|-----------|------------|-----------|-----------------------|-----------------|---------------|-----------|------------|-----------|-----------------------|-----------------|
| | Pre-heating | | Heating | | Peak Temperature (T3) | Cycle of Reflow | Pre-heating | | Heating | | Peak Temperature (T5) | Cycle of Reflow |
| | Temp. (T1) | Time (t1) | Temp. (T2) | Time (t2) | | | Temp. (T1) | Time (t1) | Temp. (T4) | Time (t3) | | |
| °C | sec. | °C | sec. | °C | Time | °C | sec. | °C | sec. | °C | Time | |
| PVZ2 | 150 to 180 | 60 to 120 | 220 | 30 to 60 | 245±3 | 2 | 150 to 180 | 60 to 120 | 220 | 30 to 60 | 260 | 2 |
| PVA2 | 150 to 180 | 60 to 120 | 220 | 30 to 60 | 245±3 | 2 | 150 to 180 | 60 to 120 | 220 | 30 to 60 | 260 +5/-0 | 2 |

2. Soldering profile for Eutectic solder (63Sn/37Pb)

(Limit profile: refer to 1)



| Series | Standard Profile | | | | | |
|--------------|------------------|-----------|------------|-----------|-----------------------|-----------------|
| | Pre-heating | | Heating | | Peak Temperature (T3) | Cycle of Reflow |
| | Temp. (T1) | Time (t1) | Temp. (T2) | Time (t2) | | |
| °C | sec. | °C | sec. | °C | Time | |
| PVZ2 PVA2 | 150 | 60 to 120 | 183 | 30 | 230 | 1 |

● Soldering Iron

| Series | Standard Condition | | | |
|--------------|-----------------------------------|----------------|-----------------------------|-------------------------|
| | Temperature of Soldering Iron Tip | Soldering Time | Soldering Iron Power Output | Cycle of Soldering Iron |
| | °C | sec. | W | Time |
| PVZ2 PVA2 | 350±10 | 3 max. | 30 max. | 1 |

■ Notice (Handling)

- Use suitable screwdrivers that fit comfortably in the driver slot. We recommend the screwdriver below.
 * Recommended screwdriver for manual adjustment
 Murata P/N: KMDR190
- The screwdriver should be set in the products vertically, do not apply more than 4.9N (Ref. 500gf) of twist and stress after mounting onto PCB to prevent contact intermittence. If excessive force is applied, the trimmer potentiometer may not function.

- Please use within the effective rotational angle.
 The trimmer potentiometer does not have a mechanical stop for over rotation. In cases out of effective rotational angle, the trimmer potentiometer may not function.
- When using a lock paint to fix the slot position or cover the rotor, please evaluate performance with your product. Lock paint may cause corrosion or electrical contact problems.

■ Notice (Other)

- Please make sure that your product has been evaluated and confirmed against your specifications when our product is mounted to your product.
- Murata cannot guarantee trimmer potentiometer integrity when used under conditions other than those specified in this document.

Trimmer Potentiometers



SMD Open Type 3mm Size PVZ3 Series

2

PVZ3 Series

■ Features

1. Excellent solderability characteristics are achieved via special plating techniques on each termination.
2. Specially designed substrate prevents wicking of flux onto the top of the part body.
3. Funnel shaped adjustment slot allows for in-process automatic adjustment.
(PVZ3A/PVZ3H/PVZ3K Series)
4. High-heat resistance type is available
(PVZ3A_C01/PVZ3K_E01).
5. Enlarged bottom termination enhances soldering strength while reducing the necessary land area required, promoting high-density PCB mounting
(PVZ3A/PVZ3H/PVZ3G Series).
6. The standard position of the driver plate is adjusted at the center normally, but another position is also available.
7. This product meets PB-free standards.
8. Complies with RoHS directive.

■ Applications

- | | |
|------------------------|----------------------|
| 1. Optical pick up | 6. CD-ROMs |
| 2. Cordless telephones | 7. Car stereos |
| 3. CD players | 8. TFT-LCD TV sets |
| 4. E-Book | 9. Headphone stereos |
| 5. Motor | |



PVZ3A



PVZ3H



PVZ3G



PVZ3K



Top Adjustment (H 1.85)

| Part Number | Power Rating (W) | Number of Turns (Effective Rotation Angle) | Mechanical Rotation Angle | Total Resistance Value | TCR (ppm/°C) |
|-------------|------------------|--|---------------------------|------------------------|--------------|
| PVZ3A221C01 | 0.1(50°C) | 1(230°±10°) | Endless | 220ohm±30% | ±500 |
| PVZ3A471C01 | 0.1(50°C) | 1(230°±10°) | Endless | 470ohm±30% | ±500 |
| PVZ3A102C01 | 0.1(50°C) | 1(230°±10°) | Endless | 1k ohm±30% | ±500 |
| PVZ3A222C01 | 0.1(50°C) | 1(230°±10°) | Endless | 2.2k ohm±30% | ±500 |
| PVZ3A472C01 | 0.1(50°C) | 1(230°±10°) | Endless | 4.7k ohm±30% | ±500 |
| PVZ3A103C01 | 0.1(50°C) | 1(230°±10°) | Endless | 10k ohm±30% | ±500 |
| PVZ3A223C01 | 0.1(50°C) | 1(230°±10°) | Endless | 22k ohm±30% | ±500 |
| PVZ3A473C01 | 0.1(50°C) | 1(230°±10°) | Endless | 47k ohm±30% | ±500 |
| PVZ3A104C01 | 0.1(50°C) | 1(230°±10°) | Endless | 100k ohm±30% | ±500 |
| PVZ3A224C01 | 0.1(50°C) | 1(230°±10°) | Endless | 220k ohm±30% | ±500 |
| PVZ3A474C01 | 0.1(50°C) | 1(230°±10°) | Endless | 470k ohm±30% | ±500 |
| PVZ3A105C01 | 0.1(50°C) | 1(230°±10°) | Endless | 1M ohm±30% | ±500 |
| PVZ3A225C01 | 0.1(50°C) | 1(230°±10°) | Endless | 2.2M ohm±30% | ±500 |

Operating Temperature Range: -25 to 85 °C
 Soldering Method: Reflow/Soldering Iron

Top Adjustment (H 1.55)

| Part Number | Power Rating (W) | Number of Turns (Effective Rotation Angle) | Mechanical Rotation Angle | Total Resistance Value | TCR (ppm/°C) |
|-------------|------------------|--|---------------------------|------------------------|--------------|
| PVZ3H221C01 | 0.1(50°C) | 1(230°±10°) | Endless | 220ohm±30% | ±500 |
| PVZ3H471C01 | 0.1(50°C) | 1(230°±10°) | Endless | 470ohm±30% | ±500 |
| PVZ3H102C01 | 0.1(50°C) | 1(230°±10°) | Endless | 1k ohm±30% | ±500 |
| PVZ3H222C01 | 0.1(50°C) | 1(230°±10°) | Endless | 2.2k ohm±30% | ±500 |
| PVZ3H472C01 | 0.1(50°C) | 1(230°±10°) | Endless | 4.7k ohm±30% | ±500 |
| PVZ3H103C01 | 0.1(50°C) | 1(230°±10°) | Endless | 10k ohm±30% | ±500 |
| PVZ3H223C01 | 0.1(50°C) | 1(230°±10°) | Endless | 22k ohm±30% | ±500 |
| PVZ3H473C01 | 0.1(50°C) | 1(230°±10°) | Endless | 47k ohm±30% | ±500 |
| PVZ3H104C01 | 0.1(50°C) | 1(230°±10°) | Endless | 100k ohm±30% | ±500 |
| PVZ3H224C01 | 0.1(50°C) | 1(230°±10°) | Endless | 220k ohm±30% | ±500 |
| PVZ3H474C01 | 0.1(50°C) | 1(230°±10°) | Endless | 470k ohm±30% | ±500 |
| PVZ3H105C01 | 0.1(50°C) | 1(230°±10°) | Endless | 1M ohm±30% | ±500 |
| PVZ3H225C01 | 0.1(50°C) | 1(230°±10°) | Endless | 2.2M ohm±30% | ±500 |

Operating Temperature Range: -25 to 85 °C
 Soldering Method: Reflow/Soldering Iron

Top Adjustment and Thin Type (H 1.15)

| Part Number | Power Rating (W) | Number of Turns (Effective Rotation Angle) | Mechanical Rotation Angle | Total Resistance Value | TCR (ppm/°C) |
|-------------|------------------|--|---------------------------|------------------------|--------------|
| PVZ3G221C01 | 0.1(50°C) | 1(230°±10°) | Endless | 220ohm±30% | ±500 |
| PVZ3G471C01 | 0.1(50°C) | 1(230°±10°) | Endless | 470ohm±30% | ±500 |
| PVZ3G102C01 | 0.1(50°C) | 1(230°±10°) | Endless | 1k ohm±30% | ±500 |
| PVZ3G222C01 | 0.1(50°C) | 1(230°±10°) | Endless | 2.2k ohm±30% | ±500 |
| PVZ3G472C01 | 0.1(50°C) | 1(230°±10°) | Endless | 4.7k ohm±30% | ±500 |
| PVZ3G103C01 | 0.1(50°C) | 1(230°±10°) | Endless | 10k ohm±30% | ±500 |
| PVZ3G223C01 | 0.1(50°C) | 1(230°±10°) | Endless | 22k ohm±30% | ±500 |
| PVZ3G473C01 | 0.1(50°C) | 1(230°±10°) | Endless | 47k ohm±30% | ±500 |
| PVZ3G104C01 | 0.1(50°C) | 1(230°±10°) | Endless | 100k ohm±30% | ±500 |
| PVZ3G224C01 | 0.1(50°C) | 1(230°±10°) | Endless | 220k ohm±30% | ±500 |
| PVZ3G474C01 | 0.1(50°C) | 1(230°±10°) | Endless | 470k ohm±30% | ±500 |
| PVZ3G105C01 | 0.1(50°C) | 1(230°±10°) | Endless | 1M ohm±30% | ±500 |
| PVZ3G225C01 | 0.1(50°C) | 1(230°±10°) | Endless | 2.2M ohm±30% | ±500 |

Operating Temperature Range: -25 to 85 °C
 Soldering Method: Reflow/Soldering Iron

Rear Adjustment

2

| Part Number | Power Rating (W) | Number of Turns (Effective Rotation Angle) | Mechanical Rotation Angle | Total Resistance Value | TCR (ppm/°C) |
|-------------|------------------|--|---------------------------|------------------------|--------------|
| PVZ3K221E01 | 0.1(50°C) | 1(230°±10°) | Endless | 220ohm±30% | ±500 |
| PVZ3K471E01 | 0.1(50°C) | 1(230°±10°) | Endless | 470ohm±30% | ±500 |
| PVZ3K102E01 | 0.1(50°C) | 1(230°±10°) | Endless | 1k ohm±30% | ±500 |
| PVZ3K222E01 | 0.1(50°C) | 1(230°±10°) | Endless | 2.2k ohm±30% | ±500 |
| PVZ3K472E01 | 0.1(50°C) | 1(230°±10°) | Endless | 4.7k ohm±30% | ±500 |
| PVZ3K103E01 | 0.1(50°C) | 1(230°±10°) | Endless | 10k ohm±30% | ±500 |
| PVZ3K223E01 | 0.1(50°C) | 1(230°±10°) | Endless | 22k ohm±30% | ±500 |
| PVZ3K473E01 | 0.1(50°C) | 1(230°±10°) | Endless | 47k ohm±30% | ±500 |
| PVZ3K104E01 | 0.1(50°C) | 1(230°±10°) | Endless | 100k ohm±30% | ±500 |
| PVZ3K224E01 | 0.1(50°C) | 1(230°±10°) | Endless | 220k ohm±30% | ±500 |
| PVZ3K474E01 | 0.1(50°C) | 1(230°±10°) | Endless | 470k ohm±30% | ±500 |
| PVZ3K105E01 | 0.1(50°C) | 1(230°±10°) | Endless | 1M ohm±30% | ±500 |
| PVZ3K225E01 | 0.1(50°C) | 1(230°±10°) | Endless | 2.2M ohm±30% | ±500 |

Operating Temperature Range: -25 to 85 °C
 Soldering Method: Reflow/Soldering Iron

Construction



Construction



Standard Land Pattern

PVZ3A/PVZ3G/PVZ3H

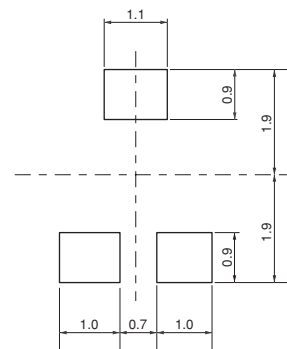

(Tolerance : ±0.1 in mm)

Construction



Continued on the following page. ↗

☞ Continued from the preceding page.

■ Construction



■ Standard Land Pattern



(Tolerance : ±0.1 in mm)

■ Characteristics

| | |
|---------------------------|--|
| Humidity Exposure | Res. Change: +10, -2% |
| High Temperature Exposure | Res. Change: $R \leq 100\text{kohm}$: +2, -10% $100\text{kohm} < R$: +2, -15% |
| Humidity Load Life | Res. Change: ±10% |
| Load Life | Res. Change: $R \leq 100\text{kohm}$: +2, -10% $100\text{kohm} < R$: +2, -15% |
| Temperature Cycle | Res. Change: ±5% |
| Rotational Life | Res. Change: ±10% (10 cycles) |

2

PVZ3 Series Notice

2

■ Notice (Operating and Storage Conditions)

1. Store in temperatures of -10 to +40°C and relative humidity of 30-85%.
2. Do not store in or near corrosive gases.
3. Use within six months after delivery.
4. Open the package just before using.
5. Do not store under direct sunlight.
6. If you use the trimmer potentiometer in an environment other than listed at right, please consult with a Murata factory representative prior to using.

The trimmer potentiometer should not be used under the following environmental conditions:

- (1) Corrosive gaseous atmosphere
(Ex. Chlorine gas, Hydrogen sulfide gas, Ammonia gas, Sulfuric acid gas, Nitric oxide gas, etc.)
- (2) In liquid
(Ex. Oil, Medical liquid, Organic solvent, etc.)
- (3) Dusty/dirty atmosphere
- (4) Direct sunlight
- (5) Static voltage or electric/magnetic fields
- (6) Direct sea breeze
- (7) Other variations of the above

■ Notice (Rating)

1. When using with partial load (rheostat), minimize the power depending on the resistance value.
2. The maximum input voltage to a trimmer potentiometer should not exceed $(P \cdot R)^{1/2}$ or the maximum operating voltage, whichever is smaller.
3. If the trimmer potentiometer is used in DC and high humidity conditions, please connect wiper (#2) for plus and resistive element (#1 or #3) for minus.

■ Notice (Soldering and Mounting)

1. Soldering
 - (1) Soldering conditions
Refer to the temperature profile.
If the soldering conditions are not suitable, e.g., excessive time and/or excessive temperature, the trimmer potentiometer may deviate from the specified characteristics.
Do not use flow soldering method (dipping).
If you use the flow soldering method, the trimmer potentiometer may not function.
 - (2) Use our standard land dimension. Excessive land area causes displacement due to the effect of the surface tension of the solder. Insufficient land area leads to insufficient soldering strength of the chip.
 - (3) Apply the appropriate amount of solder paste.
The thickness of solder paste should be printed from 100 micro m to 150 micro m and the dimension of land pattern used should be Murata's standard land pattern at reflow soldering. Insufficient amounts of solder can lead to insufficient soldering strength on PCB.
Excessive amounts of solder may cause bridging between the terminals.

- (4) The soldering iron should not come in contact with the case of the trimmer potentiometer. If such contact does occur, the trimmer potentiometer may be damaged. (PVZ Series only)

2. Mounting

- (1) Do not apply excessive force, preferably 4.9N max. (Ref. 500gf) when the trimmer potentiometer is mounted to the PCB.
- (2) Do not warp and/or bend the PC board to protect trimmer potentiometer from breakage.
- (3) In chip placers, the recommended size of the cylindrical pick-up nozzle should be outer dimension 2.5-2.8mm dia. and inner dimension 2mm dia.

3. Cleaning

- (1) In case there is flux on the resistive element, clean sufficiently with cleaning solvents and completely remove all residual flux.
- (2) Isopropyl alcohol and ethyl alcohol are applicable solvents for cleaning. If you use any other types of solvents, please evaluate performance with your product.

Continued on the following page. 

PVZ3 Series Notice

☐ Continued from the preceding page.

■ Soldering Profile

● Reflow Soldering Profile

1. Soldering profile for lead free solder (96.5Sn/3.0Ag/0.5Cu)



| Series | Standard Profile | | | | | | Limit Profile | | | | | |
|-------------|------------------|-----------|------------|-----------|-----------------------|-----------------|---------------|-----------|------------|-----------|-----------------------|-----------------|
| | Pre-heating | | Heating | | Peak Temperature (T3) | Cycle of Reflow | Pre-heating | | Heating | | Peak Temperature (T5) | Cycle of Reflow |
| | Temp. (T1) | Time (t1) | Temp. (T2) | Time (t2) | | | Temp. (T1) | Time (t1) | Temp. (T4) | Time (t3) | | |
| °C | sec. | °C | sec. | °C | Time | °C | sec. | °C | sec. | °C | Time | |
| PVZ3 | 150 to 180 | 60 to 120 | 220 | 30 to 60 | 245±3 | 2 | 150 to 180 | 60 to 120 | 220 | 30 to 60 | 260 | 2 |

2. Soldering profile for Eutectic solder (63Sn/37Pb)

(Limit profile: refer to 1)



| Series | Standard Profile | | | | | |
|-------------|------------------|-----------|------------|-----------|-----------------------|-----------------|
| | Pre-heating | | Heating | | Peak Temperature (T3) | Cycle of Reflow |
| | Temp. (T1) | Time (t1) | Temp. (T2) | Time (t2) | | |
| °C | sec. | °C | sec. | °C | Time | |
| PVZ3 | 150 | 60 to 120 | 183 | 30 | 230 max. | 1 |

● Soldering Iron

| Series | Standard Condition | | | |
|-------------|-----------------------------------|----------------|-----------------------------|-------------------------|
| | Temperature of Soldering Iron Tip | Soldering Time | Soldering Iron Power Output | Cycle of Soldering Iron |
| | °C | sec. | W | Time |
| PVZ3 | 350±10 | 3 max. | 30 max. | 1 |

■ Notice (Handling)

1. Use suitable screwdrivers that fit comfortably in the driver slot. We recommend the screwdrivers below.

* Recommended screwdriver for manual adjustment
 >VESSEL MFG.: NO.9000+1.7x30
 (Murata P/N: KMDR080)

* Recommended screwdriver for automatic adjustment
 >TORAY MFG.: JB-2225 (Murata P/N: KMBT070)

2. Don't apply more than 4.9N (Ref.: 500gf) of twist and stress after mounting onto PCB to prevent contact intermittence. If excessive force is applied, the trimmer potentiometer may not function.

3. Please use within the effective rotational angle. Do not have a mechanical stop for over rotation. In cases out of effective rotational angle, the trimmer potentiometer may not function.

4. When using a lock paint to fix the slot position or cover the rotor, please evaluate performance with your product. Lock paint may cause corrosion or electrical contact problems.

■ Notice (Other)

1. Please make sure that your product has been evaluated and confirmed against your specifications when our product is mounted to your product.

2. Murata cannot guarantee trimmer potentiometer integrity when used under conditions other than those specified in this document.

Trimmer Potentiometers



SMD Sealed Type 3mm Size PVG3 Series

■ Features

1. Sealed construction protects the interior from dust and liquid, which achieves stable performance.
2. Driver plate with cross-slot is suitable for automatic adjustment.
3. Rotor with large diameter and deep groove improves driver insertion.
4. 3mm and 4mm land pattern can be used without change. (Gull-wing is suitable for 4mm size land pattern.)
5. Heat resistance performance enables high temperature peak reflow soldering.
6. Complies with RoHS directive by new Cd free cermet resistive material. Pb free terminals with Sn plating.

■ Applications

- | | |
|-------------------------------|--------------------------|
| 1. Small sensors | 5. Compact Power Supply |
| 2. Optical Transceiver Module | 6. Wireless Radio module |
| 3. Copier | 7. Corner Sensor |
| 4. Printer | 8. E-Book |



Top Adjustment (Standard Type)

| Part Number | Power Rating (W) | Number of Turns (Effective Rotation Angle) | Mechanical Rotation Angle | Total Resistance Value | TCR (ppm/°C) |
|-------------|------------------|--|---------------------------|------------------------|--------------|
| PVG3A100C01 | 0.25(70°C) | 1(210°±10°) | 250+/-10 deg. | 10ohm±20% | ±150 |
| PVG3A200C01 | 0.25(70°C) | 1(210°±10°) | 250+/-10 deg. | 20ohm±20% | ±150 |
| PVG3A500C01 | 0.25(70°C) | 1(210°±10°) | 250+/-10 deg. | 50ohm±20% | ±150 |
| PVG3A101C01 | 0.25(70°C) | 1(210°±10°) | 250+/-10 deg. | 100ohm±20% | ±150 |
| PVG3A201C01 | 0.25(70°C) | 1(210°±10°) | 250+/-10 deg. | 200ohm±20% | ±150 |
| PVG3A501C01 | 0.25(70°C) | 1(210°±10°) | 250+/-10 deg. | 500ohm±20% | ±150 |
| PVG3A102C01 | 0.25(70°C) | 1(210°±10°) | 250+/-10 deg. | 1k ohm±20% | ±150 |
| PVG3A202C01 | 0.25(70°C) | 1(210°±10°) | 250+/-10 deg. | 2k ohm±20% | ±150 |
| PVG3A502C01 | 0.25(70°C) | 1(210°±10°) | 250+/-10 deg. | 5k ohm±20% | ±150 |
| PVG3A103C01 | 0.25(70°C) | 1(210°±10°) | 250+/-10 deg. | 10k ohm±20% | ±150 |
| PVG3A203C01 | 0.25(70°C) | 1(210°±10°) | 250+/-10 deg. | 20k ohm±20% | ±150 |
| PVG3A503C01 | 0.25(70°C) | 1(210°±10°) | 250+/-10 deg. | 50k ohm±20% | ±150 |
| PVG3A104C01 | 0.25(70°C) | 1(210°±10°) | 250+/-10 deg. | 100k ohm±20% | ±150 |
| PVG3A204C01 | 0.25(70°C) | 1(210°±10°) | 250+/-10 deg. | 200k ohm±20% | ±150 |
| PVG3A504C01 | 0.25(70°C) | 1(210°±10°) | 250+/-10 deg. | 500k ohm±20% | ±150 |
| PVG3A105C01 | 0.25(70°C) | 1(210°±10°) | 250+/-10 deg. | 1M ohm±20% | ±150 |
| PVG3A205C01 | 0.25(70°C) | 1(210°±10°) | 250+/-10 deg. | 2M ohm±20% | ±150 |

Operating Temperature Range: -55 to 125 °C
 Soldering Method: Reflow/Soldering Iron

Top Adjustment (Gull-Wing Type)

| Part Number | Power Rating (W) | Number of Turns (Effective Rotation Angle) | Mechanical Rotation Angle | Total Resistance Value | TCR (ppm/°C) |
|-------------|------------------|--|---------------------------|------------------------|--------------|
| PVG3G100C01 | 0.25(70°C) | 1(210°±10°) | 250+/-10 deg. | 10ohm±20% | ±150 |
| PVG3G200C01 | 0.25(70°C) | 1(210°±10°) | 250+/-10 deg. | 20ohm±20% | ±150 |
| PVG3G500C01 | 0.25(70°C) | 1(210°±10°) | 250+/-10 deg. | 50ohm±20% | ±150 |
| PVG3G101C01 | 0.25(70°C) | 1(210°±10°) | 250+/-10 deg. | 100ohm±20% | ±150 |
| PVG3G201C01 | 0.25(70°C) | 1(210°±10°) | 250+/-10 deg. | 200ohm±20% | ±150 |
| PVG3G501C01 | 0.25(70°C) | 1(210°±10°) | 250+/-10 deg. | 500ohm±20% | ±150 |
| PVG3G102C01 | 0.25(70°C) | 1(210°±10°) | 250+/-10 deg. | 1k ohm±20% | ±150 |
| PVG3G202C01 | 0.25(70°C) | 1(210°±10°) | 250+/-10 deg. | 2k ohm±20% | ±150 |
| PVG3G502C01 | 0.25(70°C) | 1(210°±10°) | 250+/-10 deg. | 5k ohm±20% | ±150 |
| PVG3G103C01 | 0.25(70°C) | 1(210°±10°) | 250+/-10 deg. | 10k ohm±20% | ±150 |
| PVG3G203C01 | 0.25(70°C) | 1(210°±10°) | 250+/-10 deg. | 20k ohm±20% | ±150 |
| PVG3G503C01 | 0.25(70°C) | 1(210°±10°) | 250+/-10 deg. | 50k ohm±20% | ±150 |
| PVG3G104C01 | 0.25(70°C) | 1(210°±10°) | 250+/-10 deg. | 100k ohm±20% | ±150 |
| PVG3G204C01 | 0.25(70°C) | 1(210°±10°) | 250+/-10 deg. | 200k ohm±20% | ±150 |
| PVG3G504C01 | 0.25(70°C) | 1(210°±10°) | 250+/-10 deg. | 500k ohm±20% | ±150 |
| PVG3G105C01 | 0.25(70°C) | 1(210°±10°) | 250+/-10 deg. | 1M ohm±20% | ±150 |
| PVG3G205C01 | 0.25(70°C) | 1(210°±10°) | 250+/-10 deg. | 2M ohm±20% | ±150 |

Operating Temperature Range: -55 to 125 °C
 Soldering Method: Reflow/Soldering Iron

3

Construction

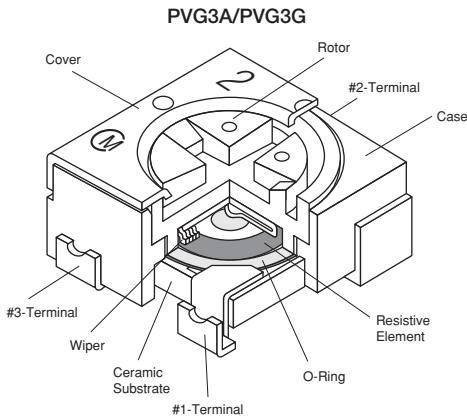

Standard Land Pattern



(Tolerance : ±0.1 in mm)



(Tolerance : ±0.1 in mm)

■ Characteristics

| | |
|---------------------------|--|
| Temperature Cycle | ΔTR : $\pm 2\%$ $\Delta V.S.S.$: $\pm 1\%$ |
| Humidity | ΔTR : $\pm 2\%$ $\Delta V.S.S.$: $\pm 1\%$ IR : 10M ohm min. |
| Vibration (20G) | ΔTR : $\pm 1\%$ $\Delta V.S.S.$: $\pm 1\%$ |
| Shock (100G) | ΔTR : $\pm 1\%$ $\Delta V.S.S.$: $\pm 1\%$ |
| Temperature Load Life | ΔTR : $\pm 3\%$ or 3 ohm max., whichever is greater $\Delta V.S.S.$: $\pm 1\%$ |
| Low Temperature Exposure | ΔTR : $\pm 2\%$ $\Delta V.S.S.$: $\pm 2\%$ |
| High Temperature Exposure | ΔTR : $\pm 3\%$ $\Delta V.S.S.$: $\pm 2\%$ |
| Rotational Life | ΔTR : $R \leq 100 \text{ kohm} \dots \pm 3\%$ or 2 ohm max., whichever is greater $R > 100 \text{ kohm} \dots +0/-10\%$ (50 cycles) |

ΔTR : Total Resistance Change
 $\Delta V.S.S.$: Voltage Setting Stability
 IR : Insulation Resistance
 R : Standard Total Resistance

PVG3 Series Notice

■ Notice (Operating and Storage Conditions)

1. Store in temperatures of -10 to +40°C and relative humidity of 30-85%.
2. Do not store in or near corrosive gases.
3. Use within six months after delivery.
4. Open the package just before using.
5. Do not store under direct sunlight.
6. If you use the trimmer potentiometer in an environment other than listed at right, please consult with a Murata factory representative prior to using.

The trimmer potentiometer should not be used under the following environmental conditions:

- (1) Corrosive gaseous atmosphere
(Ex. Chlorine gas, Hydrogen sulfide gas, Ammonia gas, Sulfuric acid gas, Nitric oxide gas, etc.)
- (2) In liquid
(Ex. Oil, Medical liquid, Organic solvent, etc.)
- (3) Dusty/dirty atmosphere
- (4) Direct sunlight
- (5) Static voltage or electric/magnetic fields
- (6) Direct sea breeze
- (7) Other variations of the above

■ Notice (Rating)

1. When using with partial load (rheostat), minimize the power depending on the resistance value.
2. The maximum input voltage to a trimmer potentiometer should not exceed $(P \cdot R)^{1/2}$ or the maximum operating voltage, whichever is smaller.

■ Notice (Soldering and Mounting)

1. Soldering

- (1) Soldering conditions
Refer to the temperature profile.
If the soldering conditions are not suitable, e.g., excessive time and/or excessive temperature, the trimmer potentiometer may deviate from the specified characteristics.
- (2) This product cannot be soldered using the flow soldering method. If you use the flow soldering method, the trimmer potentiometer may not function.
- (3) The soldering iron should not come in contact with the case of the trimmer potentiometer. If such contact does occur, the trimmer potentiometer may be damaged.
- (4) Apply the appropriate amount of solder paste.
If the amount of solder paste applied to the land is insufficient, the required adhesive strength cannot be obtained. If an excessive amount of solder paste is applied, solder bridging or flux overflow to the resistive element surface can occur.

2. Mounting

- (1) Use our standard land dimension. Excessive land area causes displacement due to the effect of the surface tension of the solder. Insufficient land area leads to insufficient soldering strength of the chip.
- (2) Do not apply excessive force, preferably 4.9N max. (Ref. 500gf) when the trimmer potentiometer is mounted to the PCB.
- (3) Do not warp and/or bend the PC board to protect trimmer potentiometer from breakage.
- (4) In chip placers, the size of the cylindrical pick-up nozzle should be outer dimension 2.5-3.0mm dia. and inner dimension 2.0-2.5mm dia.

3. Cleaning

Isopropyl alcohol and ethyl alcohol are applicable solvents for cleaning. If you use any other types of solvents, please consult with a Murata factory representative prior to using.

Continued on the following page. 

PVG3 Series Notice

Continued from the preceding page.

■ Soldering Profile

● Reflow Soldering Profile

1. Soldering profile for lead free solder (96.5Sn/3.0Ag/0.5Cu)



| Series | Standard Profile | | | | | | Limit Profile | | | | | |
|-------------|------------------|-----------|------------|-----------|-----------------------|-----------------|---------------|-----------|------------|-----------|-----------------------|-----------------|
| | Pre-heating | | Heating | | Peak Temperature (T3) | Cycle of Reflow | Pre-heating | | Heating | | Peak Temperature (T5) | Cycle of Reflow |
| | Temp. (T1) | Time (t1) | Temp. (T2) | Time (t2) | | | Temp. (T1) | Time (t1) | Temp. (T4) | Time (t3) | | |
| | °C | sec. | °C | sec. | °C | Time | °C | sec. | °C | sec. | °C | Time |
| PVG3 | 150 to 180 | 60 to 120 | 220 | 30 to 60 | 245±3 | 1 | 150 to 180 | 60 to 120 | 230 | 30 to 50 | 260 +5/-0 | 2 |

2. Soldering profile for Eutectic solder (63Sn/37Pb)

(Limit profile: refer to 1)



| Series | Standard Profile | | | | | |
|-------------|------------------|-----------|------------|-----------|-----------------------|-----------------|
| | Pre-heating | | Heating | | Peak Temperature (T3) | Cycle of Reflow |
| | Temp. (T1) | Time (t1) | Temp. (T2) | Time (t2) | | |
| | °C | sec. | °C | sec. | °C | Time |
| PVG3 | 150 | 60 to 120 | 183 | 30 | 230 | 1 |

● Soldering Iron

| Series | Standard Condition | | | |
|-------------|-----------------------------------|----------------|-----------------------------|-------------------------|
| | Temperature of Soldering Iron Tip | Soldering Time | Soldering Iron Power Output | Cycle of Soldering Iron |
| | °C | sec. | W | Time |
| PVG3 | 350±10 | 3 max. | 30 max. | 1 |

■ Notice (Handling)

1. Use suitable screwdrivers that fit comfortably in the driver slot.

* Recommended screwdriver for manual adjustment
 TORAY INDUSTRIES, INC.: SA-2225
 (Murata P/N: KMDR070)

* Recommended screwdriver bit for automatic adjustment
 TORAY INDUSTRIES, INC.: JB-2225
 (Murata P/N: KMBT070)

We can supply the screwdrivers above.

If you place an order, please specify the Murata P/N.

2. When adjusting with an adjustment tool, the applied force to the adjustment screw should not exceed 4.9N (Ref. 500gf). If excessive force is applied, the trimmer potentiometer may not function due to damage.

3. The rotational torque at the position of the adjustment range should not exceed the stop strength.

4. When using a lock paint to fix the slot position, please use adhesive resin without chlorine or sulfur (Three-bond "1401 series") and evaluate performance with your product. Lock paint may cause corrosion or electrical contact problems.

■ Notice (Other)

1. Please make sure that your product has been evaluated and confirmed against your specifications when our product is mounted to your product.

2. Murata cannot guarantee trimmer potentiometer integrity when used under conditions other than those specified in this document.

Trimmer Potentiometers



SMD Sealed Type 4mm Size PVM4 Series

■ Features

1. Sealed construction protects the interior from dust and liquid, which achieves stable performance.
2. Available for flow and reflow soldering methods while maintaining unique sealed construction.
3. Simple construction of 3-piece parts achieves high reliability.
4. Large diameter slot of rotor improves driver insertion.
5. Available for cleaning after soldering.
6. High grade version is available (PVM4AxxxD01).
7. Complies with RoHS directive by new Cd free cermet resistive material. Pb free terminals with Sn plating.

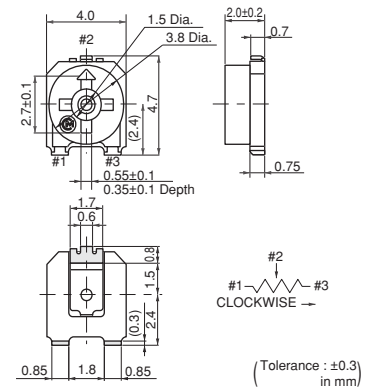

■ Applications

1. Security
2. OA, FA equipment
3. Measuring equipment
4. Professional cameras
5. Encoders
6. Sensors
7. RKE

Top Adjustment (Standard Type)

| Part Number | Power Rating (W) | Number of Turns (Effective Rotation Angle) | Mechanical Rotation Angle | Total Resistance Value | TCR (ppm/°C) |
|-------------|------------------|--|---------------------------|------------------------|--------------|
| PVM4A101C01 | 0.1(70°C) | 1(240°±10°) | Endless | 100ohm±25% | ±250 |
| PVM4A201C01 | 0.1(70°C) | 1(240°±10°) | Endless | 200ohm±25% | ±250 |
| PVM4A501C01 | 0.1(70°C) | 1(240°±10°) | Endless | 500ohm±25% | ±250 |
| PVM4A102C01 | 0.1(70°C) | 1(240°±10°) | Endless | 1k ohm±25% | ±250 |
| PVM4A202C01 | 0.1(70°C) | 1(240°±10°) | Endless | 2k ohm±25% | ±250 |
| PVM4A502C01 | 0.1(70°C) | 1(240°±10°) | Endless | 5k ohm±25% | ±250 |
| PVM4A103C01 | 0.1(70°C) | 1(240°±10°) | Endless | 10k ohm±25% | ±250 |
| PVM4A203C01 | 0.1(70°C) | 1(240°±10°) | Endless | 20k ohm±25% | ±250 |
| PVM4A503C01 | 0.1(70°C) | 1(240°±10°) | Endless | 50k ohm±25% | ±250 |
| PVM4A104C01 | 0.1(70°C) | 1(240°±10°) | Endless | 100k ohm±25% | ±250 |
| PVM4A204C01 | 0.1(70°C) | 1(240°±10°) | Endless | 200k ohm±25% | ±250 |
| PVM4A504C01 | 0.1(70°C) | 1(240°±10°) | Endless | 500k ohm±25% | ±250 |
| PVM4A105C01 | 0.1(70°C) | 1(240°±10°) | Endless | 1M ohm±25% | ±250 |
| PVM4A205C01 | 0.1(70°C) | 1(240°±10°) | Endless | 2M ohm±25% | ±250 |

Operating Temperature Range: -55 to 125 °C
 Soldering Method: Flow/Reflow/Soldering Iron

Top Adjustment (High-Liability Type)

| Part Number | Power Rating (W) | Number of Turns (Effective Rotation Angle) | Mechanical Rotation Angle | Total Resistance Value | TCR (ppm/°C) |
|-------------|------------------|--|---------------------------|------------------------|--------------|
| PVM4A101D01 | 0.25(70°C) | 1(240°±10°) | Endless | 100ohm±20% | ±100 |
| PVM4A201D01 | 0.25(70°C) | 1(240°±10°) | Endless | 200ohm±20% | ±100 |
| PVM4A501D01 | 0.25(70°C) | 1(240°±10°) | Endless | 500ohm±20% | ±100 |
| PVM4A102D01 | 0.25(70°C) | 1(240°±10°) | Endless | 1k ohm±20% | ±200 |
| PVM4A202D01 | 0.25(70°C) | 1(240°±10°) | Endless | 2k ohm±20% | ±200 |
| PVM4A502D01 | 0.25(70°C) | 1(240°±10°) | Endless | 5k ohm±20% | ±200 |
| PVM4A103D01 | 0.25(70°C) | 1(240°±10°) | Endless | 10k ohm±20% | ±150 |
| PVM4A203D01 | 0.25(70°C) | 1(240°±10°) | Endless | 20k ohm±20% | ±150 |
| PVM4A503D01 | 0.25(70°C) | 1(240°±10°) | Endless | 50k ohm±20% | ±150 |
| PVM4A104D01 | 0.25(70°C) | 1(240°±10°) | Endless | 100k ohm±20% | ±150 |
| PVM4A204D01 | 0.25(70°C) | 1(240°±10°) | Endless | 200k ohm±20% | ±150 |
| PVM4A504D01 | 0.25(70°C) | 1(240°±10°) | Endless | 500k ohm±20% | ±150 |
| PVM4A105D01 | 0.25(70°C) | 1(240°±10°) | Endless | 1M ohm±20% | ±150 |
| PVM4A205D01 | 0.25(70°C) | 1(240°±10°) | Endless | 2M ohm±20% | ±150 |

Operating Temperature Range: -55 to 125 °C
 Soldering Method: Flow/Reflow/Soldering Iron

4

Construction



Standard Land Pattern



Characteristics

| Item | PVM4A□□□C01 | PVM4A□□□D01 |
|---------------------------|-------------------------------|-------------------------------|
| Humidity Exposure | Res. Change: ±3% | Res. Change: ±2% |
| High Temperature Exposure | Res. Change: ±3% | Res. Change: ±2% |
| Humidity Load Life | Res. Change: ±3% | Res. Change: ±3% |
| Temperature Load Life | Res. Change: ±3% | Res. Change: ±3% |
| Temperature Cycle | Res. Change: ±3% | Res. Change: ±2% |
| Rotational Life | Res. Change: ±10% (20 cycles) | Res. Change: ±5% (100 cycles) |

PVM4 Series Notice

■ Notice (Operating and Storage Conditions)

1. Store in temperatures of -10 to +40°C and relative humidity of 30-85%.
2. Do not store in or near corrosive gases.
3. Use within six months after delivery.
4. Open the package just before using.
5. Do not store under direct sunlight.
6. If you use the trimmer potentiometer in an environment other than listed at right, please consult with a Murata factory representative prior to using.

The trimmer potentiometer should not be used under the following environmental conditions:

- (1) Corrosive gaseous atmosphere
(Ex. Chlorine gas, Hydrogen sulfide gas, Ammonia gas, Sulfuric acid gas, Nitric oxide gas, etc.)
- (2) In liquid
(Ex. Oil, Medical liquid, Organic solvent, etc.)
- (3) Dusty/dirty atmosphere
- (4) Direct sunlight
- (5) Static voltage or electric/magnetic fields
- (6) Direct sea breeze
- (7) Other variations of the above

■ Notice (Rating)

1. When using with partial load (rheostat), minimize the power depending on the resistance value.
2. The maximum input voltage to a trimmer potentiometer should not exceed $(P \cdot R)^{1/2}$ or the maximum operating voltage, whichever is smaller.

■ Notice (Soldering and Mounting)

1. Soldering
 - (1) Can be soldered by reflow soldering method, flow soldering method, and soldering iron.
 - (2) Use our standard land dimension. Excessive land area causes displacement due to the effect of the surface tension of the solder. Insufficient land area leads to insufficient soldering strength of the chip.
 - (3) Soldering conditions
Refer to the temperature profile.
If the soldering conditions are not suitable, e.g., excessive time and/or excessive temperature, the trimmer potentiometer may deviate from the specified characteristics.
 - (4) Apply the appropriate amount of solder paste.
The thickness of solder paste should be printed from 100 micro m to 150 micro m and the dimension of land pattern used should be Murata's standard land pattern at reflow soldering. Insufficient amounts of solder can lead to insufficient soldering strength on PCB. Excessive amounts of solder may cause bridging between the terminals.

- (5) The soldering iron should not come in contact with the case of the trimmer potentiometer. If such contact does occur, the trimmer potentiometer may be damaged.

2. Mounting

- (1) Do not apply excessive force, preferably 9.8N max. (Ref. 1kgf) when the trimmer potentiometer is mounted to the PCB.
- (2) Do not warp and/or bend the PC board to protect trimmer potentiometer from breakage.
- (3) In chip placers, the recommended size of the cylindrical pick-up nozzle should be outer dimension 4.0mm dia. and inner dimension 2.0mm dia.

3. Cleaning

Isopropyl alcohol and ethyl alcohol are available materials for cleaning.
For other materials, please consult with a Murata factory representative prior to using.

Continued on the following page. 

PVM4 Series Notice

☐ Continued from the preceding page.

■ Soldering Profile

● Flow Soldering Profile

Soldering profile for lead free solder (96.5Sn/3.0Ag/0.5Cu), Eutectic solder (63Sn/37Pb)



| Series | Standard Profile | | | | | Limit Profile | | | | |
|-------------|------------------|-------------------|------------------|-------------------|---------------|------------------|-------------------|------------------|-------------------|---------------|
| | Pre-heating | | Heating | | Cycle of Flow | Pre-heating | | Heating | | Cycle of Flow |
| | Temp. (T1) °C | Time (t1) sec. | Temp. (T2) °C | Time (t2) sec. | | Temp. (T1) °C | Time (t1) sec. | Temp. (T3) °C | Time (t2) sec. | |
| PVM4 | 150 | 60 to 120 | 250 | 5 max. | 1 | 150 | 60 to 120 | 265±3 | 5 max. | 2 |

● Reflow Soldering Profile

1. Soldering profile for Lead-free solder (96.5Sn/3.0Ag/0.5Cu)



| Series | Standard Profile | | | | | | Limit Profile | | | | | |
|-------------|------------------|-------------------|------------------|-------------------|-----------------------------|-----------------|------------------|-------------------|------------------|-------------------|-----------------------------|-----------------|
| | Pre-heating | | Heating | | Peak Temperature (T3) °C | Cycle of Reflow | Pre-heating | | Heating | | Peak Temperature (T5) °C | Cycle of Reflow |
| | Temp. (T1) °C | Time (t1) sec. | Temp. (T2) °C | Time (t2) sec. | | | Temp. (T1) °C | Time (t1) sec. | Temp. (T4) °C | Time (t3) sec. | | |
| PVM4 | 150 to 180 | 60 to 120 | 220 | 30 to 60 | 245±3 | 2 | 150 to 180 | 60 to 120 | 230 | 30 to 50 | 260 +5/-0 | 2 |

2. Soldering profile for Eutectic solder (63Sn/37Pb)

(Limit profile: refer to 1)



| Series | Standard Profile | | | | | |
|-------------|------------------|-------------------|------------------|-------------------|-----------------------------|-----------------|
| | Pre-heating | | Heating | | Peak Temperature (T3) °C | Cycle of Reflow |
| | Temp. (T1) °C | Time (t1) sec. | Temp. (T2) °C | Time (t2) sec. | | |
| PVM4 | 150 | 60 to 120 | 183 | 30 | 230 | 1 |

● Soldering Iron

| Series | Standard Condition | | | |
|-------------|---|------------------------|----------------------------------|---------------------------------|
| | Temperature of Soldering Iron Tip °C | Soldering Time sec. | Soldering Iron Power Output W | Cycle of Soldering Iron Time |
| PVM4 | 350±10 | 3 max. | 30 max. | 1 |

Continued on the following page. ☐

PVM4 Series Notice

☐ Continued from the preceding page.

■ Notice (Handling)

1. Use suitable screwdrivers that fit comfortably in the driver slot. We recommend the screwdriver below.
* Recommended screwdriver for manual adjustment
VESSEL MFG.: NO. 9000-2.6x30
(Murata P/N: KMDR120)
We can supply the screwdrivers above.
If you place an order, please specify the Murata P/N.
2. Do not apply more than 4.9N (Ref. 500gf) of twist and stress after mounting onto PCB to prevent contact intermittence. If excessive force is applied, the trimmer potentiometer may not function.

3. Please use within the effective rotational angle.
The potentiometer does not have a mechanical stop for over rotation. In cases out of effective rotational angle, the trimmer potentiometer may not function.
4. When using a lock paint to fix the slot position, please use adhesive resin without chlorine or sulfur (Three-bond "1401 series") and evaluate performance with your product. Lock paint may cause corrosion or electrical contact problems.

■ Notice (Other)

1. Please make sure that your product has been evaluated and confirmed against your specifications when our product is mounted to your product.
2. Murata cannot guarantee trimmer potentiometer integrity when used under conditions other than those specified in this document.

Trimmer Potentiometers



SMD Sealed Type Multi-turn PVG5 Series

■ Features

1. Sealed construction protects the interior from dust and liquid, which achieves stable performance.
2. Available with reflow soldering method
3. Available for ultrasonic cleaning after soldering.
4. Clutch mechanism prevents excessive wiper rotation.
5. Both top and side adjustment directions.
6. Much smaller volume (1/5-1/2) than leaded multi-turn potentiometer.
7. Complies with RoHS directive by new Cd free cermet resistive material. Pb free terminals with Sn plating.

■ Applications

1. Measuring instruments
2. OA equipment
3. Medical equipment
4. Power supply
5. Sensors
6. Base station for cellular phones



PVG5A



PVG5H

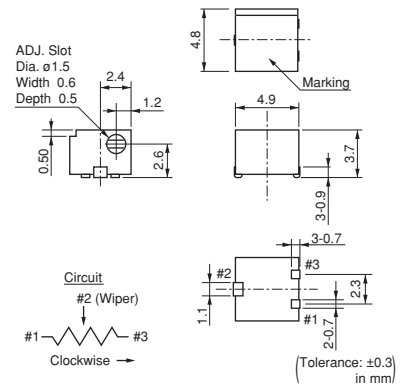

5

Top Adjustment

| Part Number | Power Rating (W) | Number of Turns (Effective Rotation Angle) | Total Resistance Value | TCR (ppm/°C) |
|-------------|------------------|--|------------------------|--------------|
| PVG5A100C03 | 0.25(70°C) | 11 | 10ohm±10% | ±150 |
| PVG5A200C03 | 0.25(70°C) | 11 | 20ohm±10% | ±150 |
| PVG5A500C03 | 0.25(70°C) | 11 | 50ohm±10% | ±150 |
| PVG5A101C03 | 0.25(70°C) | 11 | 100ohm±10% | ±150 |
| PVG5A201C03 | 0.25(70°C) | 11 | 200ohm±10% | ±150 |
| PVG5A501C03 | 0.25(70°C) | 11 | 500ohm±10% | ±150 |
| PVG5A102C03 | 0.25(70°C) | 11 | 1k ohm±10% | ±150 |
| PVG5A202C03 | 0.25(70°C) | 11 | 2k ohm±10% | ±150 |
| PVG5A502C03 | 0.25(70°C) | 11 | 5k ohm±10% | ±150 |
| PVG5A103C03 | 0.25(70°C) | 11 | 10k ohm±10% | ±150 |
| PVG5A203C03 | 0.25(70°C) | 11 | 20k ohm±10% | ±150 |
| PVG5A503C03 | 0.25(70°C) | 11 | 50k ohm±10% | ±150 |
| PVG5A104C03 | 0.25(70°C) | 11 | 100k ohm±10% | ±150 |
| PVG5A204C03 | 0.25(70°C) | 11 | 200k ohm±10% | ±150 |
| PVG5A504C03 | 0.25(70°C) | 11 | 500k ohm±10% | ±150 |
| PVG5A105C03 | 0.25(70°C) | 11 | 1M ohm±10% | ±150 |
| PVG5A205C03 | 0.25(70°C) | 11 | 2M ohm±10% | ±150 |

Operating Temperature Range: -55 to 125 °C
 Soldering Method: Reflow/Soldering Iron

Side Adjustment

| Part Number | Power Rating (W) | Number of Turns (Effective Rotation Angle) | Total Resistance Value | TCR (ppm/°C) |
|-------------|------------------|--|------------------------|--------------|
| PVG5H100C03 | 0.25(70°C) | 11 | 10ohm±10% | ±150 |
| PVG5H200C03 | 0.25(70°C) | 11 | 20ohm±10% | ±150 |
| PVG5H500C03 | 0.25(70°C) | 11 | 50ohm±10% | ±150 |
| PVG5H101C03 | 0.25(70°C) | 11 | 100ohm±10% | ±150 |
| PVG5H201C03 | 0.25(70°C) | 11 | 200ohm±10% | ±150 |
| PVG5H501C03 | 0.25(70°C) | 11 | 500ohm±10% | ±150 |
| PVG5H102C03 | 0.25(70°C) | 11 | 1k ohm±10% | ±150 |
| PVG5H202C03 | 0.25(70°C) | 11 | 2k ohm±10% | ±150 |
| PVG5H502C03 | 0.25(70°C) | 11 | 5k ohm±10% | ±150 |
| PVG5H103C03 | 0.25(70°C) | 11 | 10k ohm±10% | ±150 |
| PVG5H203C03 | 0.25(70°C) | 11 | 20k ohm±10% | ±150 |
| PVG5H503C03 | 0.25(70°C) | 11 | 50k ohm±10% | ±150 |
| PVG5H104C03 | 0.25(70°C) | 11 | 100k ohm±10% | ±150 |
| PVG5H204C03 | 0.25(70°C) | 11 | 200k ohm±10% | ±150 |
| PVG5H504C03 | 0.25(70°C) | 11 | 500k ohm±10% | ±150 |
| PVG5H105C03 | 0.25(70°C) | 11 | 1M ohm±10% | ±150 |
| PVG5H205C03 | 0.25(70°C) | 11 | 2M ohm±10% | ±150 |

Operating Temperature Range: -55 to 125 °C
 Soldering Method: Reflow/Soldering Iron

Construction



5

Standard Land Pattern



(Tolerance: ±0.1 in mm)



(Tolerance: ±0.1 in mm)

■ Characteristics

| | |
|---------------------------|--|
| Temperature Cycle | ΔTR : $\pm 2\%$ $\Delta V.S.S.$: $\pm 1\%$ |
| Humidity | ΔTR : $\pm 2\%$ IR : 10M ohm min. |
| Vibration (20G) | ΔTR : $\pm 1\%$ $\Delta V.S.S.$: $\pm 1\%$ |
| Shock (100G) | ΔTR : $\pm 1\%$ $\Delta V.S.S.$: $\pm 1\%$ |
| Temperature Load Life | ΔTR : $\pm 3\%$ or 3 ohm max., whichever is greater $\Delta V.S.S.$: $\pm 1\%$ |
| Low Temperature Exposure | ΔTR : $\pm 1\%$ $\Delta V.S.S.$: $\pm 1\%$ |
| High Temperature Exposure | ΔTR : $\pm 2\%$ $\Delta V.S.S.$: $\pm 1\%$ |
| Rotational Life | ΔTR : $\pm 3\%$ or 3 ohm max., whichever is greater (100 cycles) |

ΔTR : Total Resistance Change
 $\Delta V.S.S.$: Voltage Setting Stability
 IR : Insulation Resistance

PVG5 Series Notice

■ Notice (Operating and Storage Conditions)

1. Store in temperatures of -10 to +40°C and relative humidity of 30-85%.
2. Do not store in or near corrosive gases.
3. Use within six months after delivery.
4. Open the package just before using.
5. Do not store under direct sunlight.
6. If you use the trimmer potentiometer in an environment other than listed at right, please consult with a Murata factory representative prior to using.

The trimmer potentiometer should not be used under the following environmental conditions:

- (1) Corrosive gaseous atmosphere
(Ex. Chlorine gas, Hydrogen sulfide gas, Ammonia gas, Sulfuric acid gas, Nitric oxide gas, etc.)
- (2) In liquid
(Ex. Oil, Medical liquid, Organic solvent, etc.)
- (3) Dusty/dirty atmosphere
- (4) Direct sunlight
- (5) Static voltage or electric/magnetic fields
- (6) Direct sea breeze
- (7) Other variations of the above

■ Notice (Rating)

1. When using with partial load (rheostat), minimize the power depending on the resistance value.
2. The maximum input voltage to a trimmer potentiometer should not exceed $(P \cdot R)^{1/2}$ or the maximum operating voltage, whichever is smaller.

■ Notice (Soldering and Mounting)

1. Soldering
 - (1) Soldering conditions
Refer to the temperature profile.
If the soldering conditions are not suitable, e.g., excessive time and/or excessive temperature, the trimmer capacitor may deviate from the specified characteristics.
 - (2) This product cannot be soldered using the flow soldering method. If you use the flow soldering method, the trimmer potentiometer may not function.
 - (3) The soldering iron should not come in contact with the case of the trimmer potentiometer. If such contact does occur, the trimmer potentiometer may be damaged.
 - (4) Insufficient amounts of solder can lead to insufficient soldering strength on PCB.
Excessive amounts of solder may cause bridging between the terminals.

2. Mounting
 - (1) Use our standard land dimension. Excessive land area causes displacement due to the effect of the surface tension of the solder. Insufficient land area leads to insufficient soldering strength of the chip.
 - (2) Do not apply excessive force, preferably 9.8N max. (Ref. 1kgf) when the trimmer potentiometer is mounted to the PCB.
 - (3) Do not warp and/or bend the PC board to protect trimmer potentiometer from breakage.
 - (4) In chip placers, the recommended size of the cylindrical pick-up nozzle should be outer dimension 4.0mm dia. and inner dimension 2.0mm dia.
3. Cleaning
Isopropyl alcohol and ethyl alcohol are applicable solvents for cleaning. If you use any other types of solvents, please consult with a Murata factory representative prior to using.

Continued on the following page. 

PVG5 Series Notice

Continued from the preceding page.

■ Soldering Profile

● Reflow Soldering Profile

1. Soldering profile for lead free solder (96.5Sn/3.0Ag/0.5Cu)



| Series | Standard Profile | | | | | | Limit Profile | | | | | |
|-------------|------------------|-----------|------------|-----------|-----------------------|-----------------|---------------|-----------|------------|-----------|-----------------------|-----------------|
| | Pre-heating | | Heating | | Peak Temperature (T3) | Cycle of Reflow | Pre-heating | | Heating | | Peak Temperature (T5) | Cycle of Reflow |
| | Temp. (T1) | Time (t1) | Temp. (T2) | Time (t2) | | | Temp. (T1) | Time (t1) | Temp. (T4) | Time (t3) | | |
| °C | sec. | °C | sec. | °C | Time | °C | sec. | °C | sec. | °C | Time | |
| PVG5 | 150 to 180 | 60 to 120 | 220 | 30 to 60 | 245±3 | 2 | 150 to 180 | 60 to 120 | 230 | 30 to 50 | 260 +5/-0 | 2 |

2. Soldering profile for Eutectic solder (63Sn/37Pb)

(Limit profile: refer to 1)



| Series | Standard Profile | | | | | |
|-------------|------------------|-----------|------------|-----------|-----------------------|-----------------|
| | Pre-heating | | Heating | | Peak Temperature (T3) | Cycle of Reflow |
| | Temp. (T1) | Time (t1) | Temp. (T2) | Time (t2) | | |
| °C | sec. | °C | sec. | °C | Time | |
| PVG5 | 150 | 60 to 120 | 183 | 30 | 230 | 1 |

5

● Soldering Iron

| Series | Standard Condition | | | |
|-------------|-----------------------------------|----------------|-----------------------------|-------------------------|
| | Temperature of Soldering Iron Tip | Soldering Time | Soldering Iron Power Output | Cycle of Soldering Iron |
| | °C | sec. | W | Time |
| PVG5 | 350±10 | 3 max. | 30 max. | 1 |

■ Notice (Handling)

- Use suitable screwdrivers that fit comfortably in the driver slot. We recommend the screwdrivers below.
 * Recommended screwdrivers for manual adjustment
 <PVG5 series>
 VESSEL MFG.: NO.9000-1.3x30
 (Murata P/N: KMDR130)
 We can supply the screwdrivers above.
 If you place an order, please specify the Murata P/N.

- When adjusting with a screwdriver, do not apply excessive force, preferable 4.9N max. (Ref 500gf).
- When using a lock paint to fix the slot position, please use adhesive resin without chlorine or sulfur (Three-bond "1401 series") and evaluate performance with your product. Lock paint may cause corrosion or electrical problems.

■ Notice (Other)

- Please make sure that your product has been evaluated and confirmed against your specifications when our product is mounted to your product.
- Murata cannot guarantee trimmer potentiometer integrity when used under conditions other than those specified in this document.

Trimmer Potentiometers



Lead Sealed Type Single-turn PV32 Series

■ Features

1. Round body shape enables smaller area mount than same 6mm square potentiometer.
2. Sealed construction protects the interior from dust and liquid, which achieves stable performance.
3. Available for ultrasonic cleaning after soldering.
4. Flammability: UL94V-0
5. PV32 series complies with RoHS directive.

■ Applications

- | | |
|-------------------------|-----------------|
| 1. HDTVs | 5. Printers |
| 2. Professional cameras | 6. Sensors |
| 3. CATV | 7. Power supply |
| 4. FAX | |



PV32H



PV32N



Top Adjustment

| Part Number | Power Rating (W) | Number of Turns (Effective Rotation Angle) | Mechanical Rotation Angle | Total Resistance Value | TCR (ppm/°C) |
|-------------|------------------|--|---------------------------|------------------------|--------------|
| PV32H100A01 | 0.5(70°C) | 1(230°±5°) | 270+/-5 deg. | 10ohm±20% | ±100 |
| PV32H200A01 | 0.5(70°C) | 1(230°±5°) | 270+/-5 deg. | 20ohm±20% | ±100 |
| PV32H500A01 | 0.5(70°C) | 1(230°±5°) | 270+/-5 deg. | 50ohm±20% | ±100 |
| PV32H101A01 | 0.5(70°C) | 1(230°±5°) | 270+/-5 deg. | 100ohm±20% | ±100 |
| PV32H201A01 | 0.5(70°C) | 1(230°±5°) | 270+/-5 deg. | 200ohm±20% | ±100 |
| PV32H501A01 | 0.5(70°C) | 1(230°±5°) | 270+/-5 deg. | 500ohm±20% | ±100 |
| PV32H102A01 | 0.5(70°C) | 1(230°±5°) | 270+/-5 deg. | 1k ohm±20% | ±100 |
| PV32H202A01 | 0.5(70°C) | 1(230°±5°) | 270+/-5 deg. | 2k ohm±20% | ±100 |
| PV32H502A01 | 0.5(70°C) | 1(230°±5°) | 270+/-5 deg. | 5k ohm±20% | ±100 |
| PV32H103A01 | 0.5(70°C) | 1(230°±5°) | 270+/-5 deg. | 10k ohm±20% | ±100 |
| PV32H203A01 | 0.5(70°C) | 1(230°±5°) | 270+/-5 deg. | 20k ohm±20% | ±100 |
| PV32H503A01 | 0.5(70°C) | 1(230°±5°) | 270+/-5 deg. | 50k ohm±20% | ±100 |
| PV32H104A01 | 0.5(70°C) | 1(230°±5°) | 270+/-5 deg. | 100k ohm±20% | ±100 |
| PV32H204A01 | 0.5(70°C) | 1(230°±5°) | 270+/-5 deg. | 200k ohm±20% | ±100 |
| PV32H504A01 | 0.5(70°C) | 1(230°±5°) | 270+/-5 deg. | 500k ohm±20% | ±100 |
| PV32H105A01 | 0.5(70°C) | 1(230°±5°) | 270+/-5 deg. | 1M ohm±20% | ±100 |
| PV32H205A01 | 0.5(70°C) | 1(230°±5°) | 270+/-5 deg. | 2M ohm±20% | ±100 |
| PV32H505A01 | 0.5(70°C) | 1(230°±5°) | 270+/-5 deg. | 5M ohm±20% | ±100 |

Operating Temperature Range: -55 to 125 °C
 Soldering Method: Flow/Soldering Iron

Side Adjustment

| Part Number | Power Rating (W) | Number of Turns (Effective Rotation Angle) | Mechanical Rotation Angle | Total Resistance Value | TCR (ppm/°C) |
|-------------|------------------|--|---------------------------|------------------------|--------------|
| PV32N100A01 | 0.5(70°C) | 1(230°±5°) | 270+/-5 deg. | 10ohm±20% | ±100 |
| PV32N200A01 | 0.5(70°C) | 1(230°±5°) | 270+/-5 deg. | 20ohm±20% | ±100 |
| PV32N500A01 | 0.5(70°C) | 1(230°±5°) | 270+/-5 deg. | 50ohm±20% | ±100 |
| PV32N101A01 | 0.5(70°C) | 1(230°±5°) | 270+/-5 deg. | 100ohm±20% | ±100 |
| PV32N201A01 | 0.5(70°C) | 1(230°±5°) | 270+/-5 deg. | 200ohm±20% | ±100 |
| PV32N501A01 | 0.5(70°C) | 1(230°±5°) | 270+/-5 deg. | 500ohm±20% | ±100 |
| PV32N102A01 | 0.5(70°C) | 1(230°±5°) | 270+/-5 deg. | 1k ohm±20% | ±100 |
| PV32N202A01 | 0.5(70°C) | 1(230°±5°) | 270+/-5 deg. | 2k ohm±20% | ±100 |
| PV32N502A01 | 0.5(70°C) | 1(230°±5°) | 270+/-5 deg. | 5k ohm±20% | ±100 |
| PV32N103A01 | 0.5(70°C) | 1(230°±5°) | 270+/-5 deg. | 10k ohm±20% | ±100 |
| PV32N203A01 | 0.5(70°C) | 1(230°±5°) | 270+/-5 deg. | 20k ohm±20% | ±100 |
| PV32N503A01 | 0.5(70°C) | 1(230°±5°) | 270+/-5 deg. | 50k ohm±20% | ±100 |
| PV32N104A01 | 0.5(70°C) | 1(230°±5°) | 270+/-5 deg. | 100k ohm±20% | ±100 |
| PV32N204A01 | 0.5(70°C) | 1(230°±5°) | 270+/-5 deg. | 200k ohm±20% | ±100 |
| PV32N504A01 | 0.5(70°C) | 1(230°±5°) | 270+/-5 deg. | 500k ohm±20% | ±100 |
| PV32N105A01 | 0.5(70°C) | 1(230°±5°) | 270+/-5 deg. | 1M ohm±20% | ±100 |
| PV32N205A01 | 0.5(70°C) | 1(230°±5°) | 270+/-5 deg. | 2M ohm±20% | ±100 |
| PV32N505A01 | 0.5(70°C) | 1(230°±5°) | 270+/-5 deg. | 5M ohm±20% | ±100 |

Operating Temperature Range: -55 to 125 °C
 Soldering Method: Flow/Soldering Iron

Construction



6

Standard Mounting Holes

PV32H



(Tolerance: ±0.1 in mm)

PV32N



(Tolerance: ±0.1 in mm)

■ Characteristics

| | |
|---------------------------|--|
| Temperature Cycle | ΔTR : $\pm 2\%$ $\Delta V.S.S.$: $\pm 1\%$ |
| Humidity | ΔTR : $\pm 2\%$ IR : 100M ohm min. |
| Vibration (20G) | ΔTR : $\pm 1\%$ $\Delta V.S.S.$: $\pm 1\%$ |
| Shock (100G) | ΔTR : $\pm 1\%$ $\Delta V.S.S.$: $\pm 1\%$ |
| Temperature Load Life | ΔTR : $\pm 2\%$ $\Delta V.S.S.$: $\pm 2\%$ |
| Low Temperature Exposure | ΔTR : $\pm 2\%$ $\Delta V.S.S.$: $\pm 1\%$ |
| High Temperature Exposure | ΔTR : $\pm 2\%$ $\Delta V.S.S.$: $\pm 1\%$ |
| Rotational Life | ΔTR : $\pm 4\%$ (200 cycles) |

ΔTR : Total Resistance Change
 $\Delta V.S.S.$: Voltage Setting Stability
 IR : Insulation Resistance

PV32 Series Notice

■ Notice (Operating and Storage Conditions)

1. Store in temperatures of -10 to +40°C and relative humidity of 30-85%.
2. Do not store in or near corrosive gases.
3. Use within six months after delivery.
4. Open the package just before using.
5. Do not store under direct sunlight.
6. If you use the trimmer potentiometer in an environment other than listed at right, please consult with a Murata factory representative prior to using.

The trimmer potentiometer should not be used under the following environmental conditions:

- (1) Corrosive gaseous atmosphere
(Ex. Chlorine gas, Hydrogen sulfide gas, Ammonia gas, Sulfuric acid gas, Nitric oxide gas, etc.)
- (2) In liquid
(Ex. Oil, Medical liquid, Organic solvent, etc.)
- (3) Dusty/dirty atmosphere
- (4) Direct sunlight
- (5) Static voltage or electric/magnetic fields
- (6) Direct sea breeze
- (7) Other variations of the above

■ Notice (Rating)

1. When using with partial load (rheostat), minimize the power depending on the resistance value.
2. The maximum input voltage to a trimmer potentiometer should not exceed $(P \cdot R)^{1/2}$ or the maximum operating voltage, whichever is smaller.

■ Notice (Soldering and Mounting)

1. Soldering

(1) Soldering conditions

Refer to the temperature profile.

If the soldering conditions are not suitable, e.g., excessive time and/or excessive temperature, the trimmer potentiometer may deviate from the specified characteristics.

(2) To minimize mechanical stress when adjusting, the trimmer potentiometer should be mounted onto the PCB without a gap.

(3) The soldering iron should not come in contact with the case of the trimmer potentiometer. If such contact does occur, the trimmer potentiometer may be damaged.

2. Mounting

(1) Use the PCB hole to meet the pin of the trimmer potentiometer. If the trimmer potentiometer is installed into an insufficient PCB hole, the trimmer potentiometer may be damaged by mechanical stress.

(2) Do not apply excessive force, preferably 9.8N max. (Ref. 1kgf) when the trimmer potentiometer is mounted to the PCB.

3. Cleaning

Isopropyl alcohol and ethyl alcohol are applicable solvents for cleaning. If you use any other types of solvents, please consult with a Murata factory representative prior to using.

Continued on the following page. 

PV32 Series Notice

☐ Continued from the preceding page.

■ Soldering Profile

● Flow Soldering Profile

Soldering profile for lead free solder (96.5Sn/3.0Ag/0.5Cu), Eutectic solder (63Sn/37Pb)



| Series | Standard Profile | | | | | Limit Profile | | | | |
|--------|------------------|-----------|------------|-----------|---------------|---------------|-----------|------------|-----------|---------------|
| | Pre-heating | | Heating | | Cycle of Flow | Pre-heating | | Heating | | Cycle of Flow |
| | Temp. (T1) | Time (t1) | Temp. (T2) | Time (t2) | | Temp. (T1) | Time (t1) | Temp. (T3) | Time (t2) | |
| | °C | sec. | °C | sec. | Time | °C | sec. | °C | sec. | Time |
| PV32 | 150 | 60 to 120 | 250 | 5 max. | 1 | 150 | 60 to 120 | 260 | 3 max. | 1 |

● Soldering Iron

| Series | Standard Condition | | | |
|--------|-----------------------------------|----------------|-----------------------------|-------------------------|
| | Temperature of Soldering Iron Tip | Soldering Time | Soldering Iron Power Output | Cycle of Soldering Iron |
| | °C | sec. | W | Time |
| PV32 | 350±10 | 3 max. | 30 max. | 1 |

■ Notice (Handling)

- Use suitable screwdrivers that fit comfortably in the driver slot. We recommend the screwdrivers below.
 * Recommended screwdriver for manual adjustment <PV32 series>
 ENGINEER INC.: DA-40
 (Murata P/N: KMDR180)
 We can supply the screwdrivers above.
 If you place an order, please specify the Murata P/N.
- When adjusting with an adjustment tool, the applied force to the adjustment screw should not exceed 4.9N (Ref. 500gf). If excessive force is applied, the trimmer potentiometer may not function due to damage.
- The rotational torque at the position of the adjustment range should not exceed the stop strength.
- When using a lock paint to fix the slot position, please use adhesive resin without chlorine or sulfur (Three-bond "1401 series") and evaluate performance with your product. Lock paint may cause corrosion or electrical contact problems.

■ Notice (Other)

- Please make sure that your product has been evaluated and confirmed against your specifications when our product is mounted to your product.
- Murata cannot guarantee trimmer potentiometer integrity when used under conditions other than those specified in this document.

Trimmer Potentiometers



Lead Sealed Type Multi-turn PV12/PV37/PV36 Series

PV12 Series

■ Features

1. The unique inner gear system recognizes the position of the center of the shaft of the potentiometer.
2. Sealed construction protects the interior from dust and liquid, which achieves stable performance.
3. Available for ultrasonic cleaning after soldering.
4. Clutch mechanism prevents excessive wiper rotation.
5. PV12 series complies with RoHS directive.

■ Applications

- | | |
|-------------------------|-----------------------------|
| 1. HDTVs | 5. Printers |
| 2. Professional cameras | 6. Sensors |
| 3. CATV | 7. Switching power supplies |
| 4. FAX | |

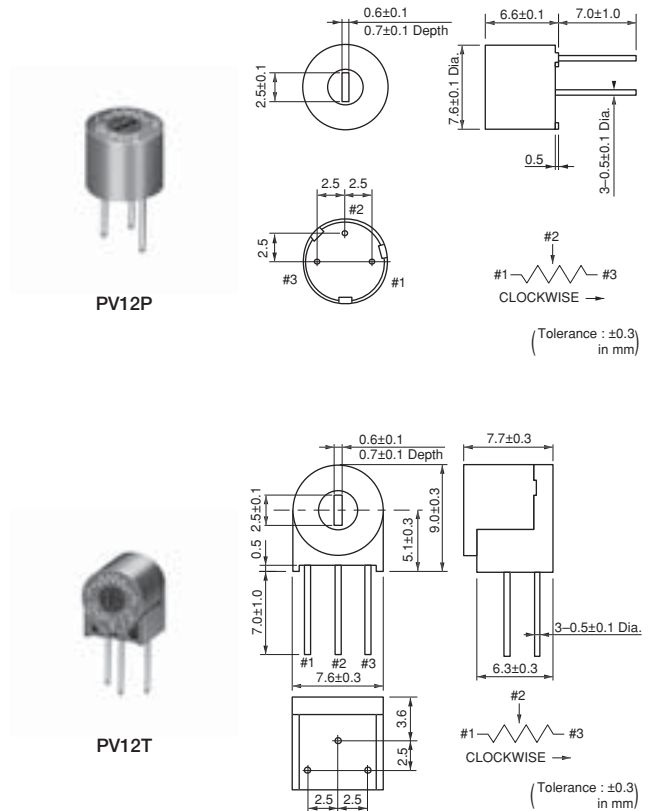

Top Adjustment

| Part Number | Power Rating (W) | Number of Turns (Effective Rotation Angle) | Total Resistance Value | TCR (ppm/°C) |
|-------------|------------------|--|------------------------|--------------|
| PV12P100A01 | 0.5(70°C) | 4 | 10ohm±10% | ±100 |
| PV12P200A01 | 0.5(70°C) | 4 | 20ohm±10% | ±100 |
| PV12P500A01 | 0.5(70°C) | 4 | 50ohm±10% | ±100 |
| PV12P101A01 | 0.5(70°C) | 4 | 100ohm±10% | ±100 |
| PV12P201A01 | 0.5(70°C) | 4 | 200ohm±10% | ±100 |
| PV12P501A01 | 0.5(70°C) | 4 | 500ohm±10% | ±100 |
| PV12P102A01 | 0.5(70°C) | 4 | 1k ohm±10% | ±100 |
| PV12P202A01 | 0.5(70°C) | 4 | 2k ohm±10% | ±100 |
| PV12P502A01 | 0.5(70°C) | 4 | 5k ohm±10% | ±100 |
| PV12P103A01 | 0.5(70°C) | 4 | 10k ohm±10% | ±100 |
| PV12P203A01 | 0.5(70°C) | 4 | 20k ohm±10% | ±100 |
| PV12P503A01 | 0.5(70°C) | 4 | 50k ohm±10% | ±100 |
| PV12P104A01 | 0.5(70°C) | 4 | 100k ohm±10% | ±100 |
| PV12P204A01 | 0.5(70°C) | 4 | 200k ohm±10% | ±100 |
| PV12P504A01 | 0.5(70°C) | 4 | 500k ohm±10% | ±100 |
| PV12P105A01 | 0.5(70°C) | 4 | 1M ohm±10% | ±100 |
| PV12P205A01 | 0.5(70°C) | 4 | 2M ohm±10% | ±100 |

Operating Temperature Range: -55 to 125 °C
 Soldering Method: Flow/Soldering Iron

7

Side Adjustment

| Part Number | Power Rating (W) | Number of Turns (Effective Rotation Angle) | Total Resistance Value | TCR (ppm/°C) |
|-------------|------------------|--|------------------------|--------------|
| PV12T100A01 | 0.5(70°C) | 4 | 10ohm±10% | ±100 |
| PV12T200A01 | 0.5(70°C) | 4 | 20ohm±10% | ±100 |
| PV12T500A01 | 0.5(70°C) | 4 | 50ohm±10% | ±100 |
| PV12T101A01 | 0.5(70°C) | 4 | 100ohm±10% | ±100 |
| PV12T201A01 | 0.5(70°C) | 4 | 200ohm±10% | ±100 |
| PV12T501A01 | 0.5(70°C) | 4 | 500ohm±10% | ±100 |
| PV12T102A01 | 0.5(70°C) | 4 | 1k ohm±10% | ±100 |
| PV12T202A01 | 0.5(70°C) | 4 | 2k ohm±10% | ±100 |
| PV12T502A01 | 0.5(70°C) | 4 | 5k ohm±10% | ±100 |
| PV12T103A01 | 0.5(70°C) | 4 | 10k ohm±10% | ±100 |
| PV12T203A01 | 0.5(70°C) | 4 | 20k ohm±10% | ±100 |
| PV12T503A01 | 0.5(70°C) | 4 | 50k ohm±10% | ±100 |
| PV12T104A01 | 0.5(70°C) | 4 | 100k ohm±10% | ±100 |
| PV12T204A01 | 0.5(70°C) | 4 | 200k ohm±10% | ±100 |
| PV12T504A01 | 0.5(70°C) | 4 | 500k ohm±10% | ±100 |
| PV12T105A01 | 0.5(70°C) | 4 | 1M ohm±10% | ±100 |
| PV12T205A01 | 0.5(70°C) | 4 | 2M ohm±10% | ±100 |

Operating Temperature Range: -55 to 125 °C
 Soldering Method: Flow/Soldering Iron

Construction



Standard Mounting Holes

PV12P



(Tolerance: ±0.1 in mm)

PV12T



(Tolerance: ±0.1 in mm)

■ Characteristics

| | |
|---------------------------|--|
| Temperature Cycle | ΔTR : $\pm 2\%$ $\Delta V.S.S.$: $\pm 1\%$ |
| Humidity | ΔTR : $\pm 2\%$ IR : 100M ohm min. |
| Vibration (20G) | ΔTR : $\pm 1\%$ $\Delta V.S.S.$: $\pm 1\%$ |
| Shock (100G) | ΔTR : $\pm 1\%$ $\Delta V.S.S.$: $\pm 1\%$ |
| Temperature Load Life | ΔTR : $\pm 3\%$ $\Delta V.S.S.$: $\pm 2\%$ |
| Low Temperature Exposure | ΔTR : $\pm 3\%$ $\Delta V.S.S.$: $\pm 1.5\%$ |
| High Temperature Exposure | ΔTR : $\pm 3\%$ $\Delta V.S.S.$: $\pm 1.5\%$ |
| Rotational Life | ΔTR : $\pm 3\%$ (200 cycles) |

ΔTR : Total Resistance Change
 $\Delta V.S.S.$: Voltage Setting Stability
 IR : Insulation Resistance

PV37 Series

■ Features

1. Smaller volume (about one-third) than 25-turn potentiometer
2. Sealed construction protects the interior from dust and liquid, which achieves stable performance.
3. Available for ultrasonic cleaning after soldering.
4. Clutch mechanism prevents excessive wiper rotation.
5. Both top and side adjustment directions.
6. Complies with RoHS directive by new Cd free cermet resistive material. Pb free terminals with Sn plating.

■ Applications

1. Measuring instruments
2. OA equipment
3. Medical equipment
4. Power supply
5. Base station for cellular phones



Top Adjustment

| Part Number | Power Rating (W) | Number of Turns (Effective Rotation Angle) | Total Resistance Value | TCR (ppm/°C) |
|-------------|------------------|--|------------------------|--------------|
| PV37W100C01 | 0.25(85°C) | 12 | 10ohm±10% | ±150 |
| PV37W200C01 | 0.25(85°C) | 12 | 20ohm±10% | ±150 |
| PV37W500C01 | 0.25(85°C) | 12 | 50ohm±10% | ±150 |
| PV37W101C01 | 0.25(85°C) | 12 | 100ohm±10% | ±150 |
| PV37W201C01 | 0.25(85°C) | 12 | 200ohm±10% | ±150 |
| PV37W501C01 | 0.25(85°C) | 12 | 500ohm±10% | ±150 |
| PV37W102C01 | 0.25(85°C) | 12 | 1k ohm±10% | ±150 |
| PV37W202C01 | 0.25(85°C) | 12 | 2k ohm±10% | ±150 |
| PV37W502C01 | 0.25(85°C) | 12 | 5k ohm±10% | ±150 |
| PV37W103C01 | 0.25(85°C) | 12 | 10k ohm±10% | ±150 |
| PV37W203C01 | 0.25(85°C) | 12 | 20k ohm±10% | ±150 |
| PV37W503C01 | 0.25(85°C) | 12 | 50k ohm±10% | ±150 |
| PV37W104C01 | 0.25(85°C) | 12 | 100k ohm±10% | ±150 |
| PV37W204C01 | 0.25(85°C) | 12 | 200k ohm±10% | ±150 |
| PV37W504C01 | 0.25(85°C) | 12 | 500k ohm±10% | ±150 |
| PV37W105C01 | 0.25(85°C) | 12 | 1M ohm±10% | ±150 |
| PV37W205C01 | 0.25(85°C) | 12 | 2M ohm±10% | ±150 |

Operating Temperature Range: -55 to 125 °C
 Soldering Method: Flow/Soldering Iron

Side Adjustment

| Part Number | Power Rating (W) | Number of Turns (Effective Rotation Angle) | Total Resistance Value | TCR (ppm/°C) |
|-------------|------------------|--|------------------------|--------------|
| PV37X100C01 | 0.25(85°C) | 12 | 10ohm±10% | ±150 |
| PV37X200C01 | 0.25(85°C) | 12 | 20ohm±10% | ±150 |
| PV37X500C01 | 0.25(85°C) | 12 | 50ohm±10% | ±150 |
| PV37X101C01 | 0.25(85°C) | 12 | 100ohm±10% | ±150 |
| PV37X201C01 | 0.25(85°C) | 12 | 200ohm±10% | ±150 |
| PV37X501C01 | 0.25(85°C) | 12 | 500ohm±10% | ±150 |
| PV37X102C01 | 0.25(85°C) | 12 | 1k ohm±10% | ±150 |
| PV37X202C01 | 0.25(85°C) | 12 | 2k ohm±10% | ±150 |
| PV37X502C01 | 0.25(85°C) | 12 | 5k ohm±10% | ±150 |
| PV37X103C01 | 0.25(85°C) | 12 | 10k ohm±10% | ±150 |
| PV37X203C01 | 0.25(85°C) | 12 | 20k ohm±10% | ±150 |
| PV37X503C01 | 0.25(85°C) | 12 | 50k ohm±10% | ±150 |
| PV37X104C01 | 0.25(85°C) | 12 | 100k ohm±10% | ±150 |
| PV37X204C01 | 0.25(85°C) | 12 | 200k ohm±10% | ±150 |
| PV37X504C01 | 0.25(85°C) | 12 | 500k ohm±10% | ±150 |
| PV37X105C01 | 0.25(85°C) | 12 | 1M ohm±10% | ±150 |
| PV37X205C01 | 0.25(85°C) | 12 | 2M ohm±10% | ±150 |

Operating Temperature Range: -55 to 125 °C
 Soldering Method: Flow/Soldering Iron

Construction



Standard Mounting Holes

PV37W/PV37X



(Tolerance: ±0.1 in mm)

7

Characteristics

| | |
|---------------------------|--|
| Temperature Cycle | ΔTR : ±1% $\Delta V.S.S.$: ±1% |
| Humidity | ΔTR : ±2% IR : 100M ohm min. |
| Vibration (20G) | ΔTR : ±1% $\Delta V.S.S.$: ±1% |
| Shock (100G) | ΔTR : ±1% $\Delta V.S.S.$: ±1% |
| Temperature Load Life | ΔTR : ±2% $\Delta V.S.S.$: ±1% |
| Low Temperature Exposure | ΔTR : ±1% $\Delta V.S.S.$: ±1% |
| High Temperature Exposure | ΔTR : ±2% $\Delta V.S.S.$: ±1% |
| Rotational Life | ΔTR : $R \leq 100$ ohm ... ±3% $R > 100$ ohm ... ±2% (200 cycles) |

ΔTR : Total Resistance Change
 $\Delta V.S.S.$: Voltage Setting Stability
 IR : Insulation Resistance
 R : Standard Total Resistance

PV36 Series

■ Features

1. High resolution 25-turns potentiometer enables precision adjustment easily.
2. Sealed construction protects the interior from dust and liquid, which achieves stable performance.
3. Available for ultrasonic cleaning after soldering.
4. Clutch mechanism prevents excessive wiper rotation.
5. Both top and side adjustment directions.
6. Complies with RoHS directive by new Cd free cermet resistive material. Pb free terminals with Sn plating.

■ Applications

1. Measuring instruments
2. OA equipment
3. Medical equipment
4. Power supply
5. Base station for cellular phones



Top Adjustment

| Part Number | Power Rating (W) | Number of Turns (Effective Rotation Angle) | Total Resistance Value | TCR (ppm/°C) |
|-------------|------------------|--|------------------------|--------------|
| PV36W100C01 | 0.5(70°C) | 25 | 10ohm±10% | ±150 |
| PV36W200C01 | 0.5(70°C) | 25 | 20ohm±10% | ±150 |
| PV36W500C01 | 0.5(70°C) | 25 | 50ohm±10% | ±150 |
| PV36W101C01 | 0.5(70°C) | 25 | 100ohm±10% | ±150 |
| PV36W201C01 | 0.5(70°C) | 25 | 200ohm±10% | ±100 |
| PV36W501C01 | 0.5(70°C) | 25 | 500ohm±10% | ±100 |
| PV36W102C01 | 0.5(70°C) | 25 | 1k ohm±10% | ±100 |
| PV36W202C01 | 0.5(70°C) | 25 | 2k ohm±10% | ±100 |
| PV36W502C01 | 0.5(70°C) | 25 | 5k ohm±10% | ±100 |
| PV36W103C01 | 0.5(70°C) | 25 | 10k ohm±10% | ±100 |
| PV36W203C01 | 0.5(70°C) | 25 | 20k ohm±10% | ±100 |
| PV36W503C01 | 0.5(70°C) | 25 | 50k ohm±10% | ±100 |
| PV36W104C01 | 0.5(70°C) | 25 | 100k ohm±10% | ±100 |
| PV36W204C01 | 0.5(70°C) | 25 | 200k ohm±10% | ±100 |
| PV36W504C01 | 0.5(70°C) | 25 | 500k ohm±10% | ±100 |
| PV36W105C01 | 0.5(70°C) | 25 | 1M ohm±10% | ±100 |
| PV36W205C01 | 0.5(70°C) | 25 | 2M ohm±10% | ±100 |

Operating Temperature Range: -55 to 125 °C
 Soldering Method: Flow/Soldering Iron

7

Side Adjustment

| Part Number | Power Rating (W) | Number of Turns (Effective Rotation Angle) | Total Resistance Value | TCR (ppm/°C) |
|-------------|------------------|--|------------------------|--------------|
| PV36X100C01 | 0.5(70°C) | 25 | 10ohm±10% | ±150 |
| PV36X200C01 | 0.5(70°C) | 25 | 20ohm±10% | ±150 |
| PV36X500C01 | 0.5(70°C) | 25 | 50ohm±10% | ±150 |
| PV36X101C01 | 0.5(70°C) | 25 | 100ohm±10% | ±150 |
| PV36X201C01 | 0.5(70°C) | 25 | 200ohm±10% | ±100 |
| PV36X501C01 | 0.5(70°C) | 25 | 500ohm±10% | ±100 |
| PV36X102C01 | 0.5(70°C) | 25 | 1k ohm±10% | ±100 |
| PV36X202C01 | 0.5(70°C) | 25 | 2k ohm±10% | ±100 |
| PV36X502C01 | 0.5(70°C) | 25 | 5k ohm±10% | ±100 |
| PV36X103C01 | 0.5(70°C) | 25 | 10k ohm±10% | ±100 |
| PV36X203C01 | 0.5(70°C) | 25 | 20k ohm±10% | ±100 |
| PV36X503C01 | 0.5(70°C) | 25 | 50k ohm±10% | ±100 |
| PV36X104C01 | 0.5(70°C) | 25 | 100k ohm±10% | ±100 |
| PV36X204C01 | 0.5(70°C) | 25 | 200k ohm±10% | ±100 |
| PV36X504C01 | 0.5(70°C) | 25 | 500k ohm±10% | ±100 |
| PV36X105C01 | 0.5(70°C) | 25 | 1M ohm±10% | ±100 |
| PV36X205C01 | 0.5(70°C) | 25 | 2M ohm±10% | ±100 |

Operating Temperature Range: -55 to 125 °C
 Soldering Method: Flow/Soldering Iron

Construction



Standard Mounting Holes PV36W/X



(Tolerance: ±0.1 in mm)

7

Characteristics

| | |
|---------------------------|--|
| Temperature Cycle | ΔTR : ±2% ΔV.S.S.: ±1% |
| Humidity | ΔTR : ±2% IR : 100M ohm min. |
| Vibration (20G) | ΔTR : ±1% ΔV.S.S.: ±1% |
| Shock (100G) | ΔTR : ±1% ΔV.S.S.: ±1% |
| Temperature Load Life | ΔTR : ±3% ΔV.S.S.: ±1% |
| Low Temperature Exposure | ΔTR : ±2% ΔV.S.S.: ±1% |
| High Temperature Exposure | ΔTR : ±3% ΔV.S.S.: ±1% |
| Rotational Life | ΔTR : R≤1k ohm, R≥500k ohm ... ±5% 1k ohm<R<500k ohm ... ±3% (200 cycles) |

ΔTR : Total Resistance Change
 ΔV.S.S.: Voltage Setting Stability
 IR : Insulation Resistance
 R : Standard Total Resistance

PV12/PV37/PV36 Series Notice

■ Notice (Operating and Storage Conditions)

1. Store in temperatures of -10 to +40°C and relative humidity of 30-85%.
2. Do not store in or near corrosive gases.
3. Use within six months after delivery.
4. Open the package just before using.
5. Do not store under direct sunlight.
6. If you use the trimmer potentiometer in an environment other than listed at right, please consult with a Murata factory representative prior to using.

The trimmer potentiometer should not be used under the following environmental conditions:

- (1) Corrosive gaseous atmosphere
(Ex. Chlorine gas, Hydrogen sulfide gas, Ammonia gas, Sulfuric acid gas, Nitric oxide gas, etc.)
- (2) In liquid
(Ex. Oil, Medical liquid, Organic solvent, etc.)
- (3) Dusty/dirty atmosphere
- (4) Direct sunlight
- (5) Static voltage or electric/magnetic fields
- (6) Direct sea breeze
- (7) Other variations of the above

■ Notice (Rating)

1. When using with partial load (rheostat), minimize the power depending on the resistance value.
2. The maximum input voltage to a trimmer potentiometer should not exceed $(P \cdot R)^{1/2}$ or the maximum operating voltage, whichever is smaller.

■ Notice (Soldering and Mounting)

1. Soldering
 - (1) Soldering conditions
Refer to the temperature profile.
If the soldering conditions are not suitable, e.g., excessive time and/or excessive temperature, the trimmer potentiometer may deviate from the specified characteristics.
 - (2) To minimize mechanical stress when adjusting, the trimmer potentiometer should be mounted onto the PCB without a gap.
 - (3) The soldering iron should not come in contact with the case of the trimmer potentiometer. If such contact does occur, the trimmer potentiometer may be damaged.

2. Mounting
 - (1) Use the PCB hole to meet the pin of the trimmer potentiometer. If the trimmer potentiometer is installed into an insufficient PCB hole, the trimmer potentiometer may be damaged by mechanical stress.
 - (2) Do not apply excessive force, preferably 9.8N max. (Ref. 1kgf) when the trimmer potentiometer is mounted to the PCB.
3. Cleaning
Isopropyl alcohol and ethyl alcohol are applicable solvents for cleaning. If you use any other types of solvents, please consult with a Murata factory representative prior to using.

Continued on the following page. 

PV12/PV37/PV36 Series Notice

☐ Continued from the preceding page.

■ Soldering Profile

● Flow Soldering Profile

Soldering profile for lead free solder (96.5Sn/3.0Ag/0.5Cu), Eutectic solder (63Sn/37Pb)



| Series | Standard Profile | | | | | Limit Profile | | | | |
|----------------------|------------------|-----------|------------|-----------|---------------|---------------|-----------|------------|-----------|---------------|
| | Pre-heating | | Heating | | Cycle of Flow | Pre-heating | | Heating | | Cycle of Flow |
| | Temp. (T1) | Time (t1) | Temp. (T2) | Time (t2) | | Temp. (T1) | Time (t1) | Temp. (T3) | Time (t2) | |
| | °C | sec. | °C | sec. | Time | °C | sec. | °C | sec. | Time |
| PV12 PV37 PV36 | 150 | 60 to 120 | 250 | 5 max. | 1 | 150 | 60 to 120 | 260 | 3 max. | 1 |

● Soldering Iron

| Series | Standard Condition | | | |
|----------------------|-----------------------------------|----------------|-----------------------------|-------------------------|
| | Temperature of Soldering Iron Tip | Soldering Time | Soldering Iron Power Output | Cycle of Soldering Iron |
| | °C | sec. | W | Time |
| PV12 PV37 PV36 | 350±10 | 3 max. | 30 max. | 1 |

■ Notice (Handling)

- Use suitable screwdrivers that fit comfortably in the driver slot. We recommend the screwdrivers below.
 * Recommended screwdriver for manual adjustment
 ENGINEER INC.: DA-40
 (Murata P/N: KMDR180)

We can supply the screwdrivers above.

If you place an order, please specify the Murata P/N.

- When adjusting with an adjustment tool, the applied force to the adjustment screw should not exceed 4.9N (Ref. 500gf). If excessive force is applied, the trimmer potentiometer may not function due to damage.

- When using a lock paint to fix the slot position, please use adhesive resin without chlorine or sulfur (Three-bond "1401 series") and evaluate performance with your product. Lock paint may cause corrosion or electrical contact problems.

■ Notice (Other)

- Please make sure that your product has been evaluated and confirmed against your specifications when our product is mounted to your product.
- Murata cannot guarantee trimmer potentiometer integrity when used under conditions other than those specified in this document.

7

SMD Open Type (PVZ2/A2/Z3)/SMD Sealed Type (PVM4A_C01 Series) Specifications and Test Methods

The tests and measurements should be conducted under the conditions of 15 to 35°C of temperature, 25 to 75% of relative humidity and 86 to 106 kpa of atmospheric pressure unless otherwise specified. If questionable results occur that have been measured in accordance with the above-mentioned conditions, the tests and measurements should be conducted under the conditions of 25±2°C of temperature, 45 to 55% of relative humidity and 86 to 106 kpa of atmospheric pressure.

| No. | Item | Test Methods | | | | | | | | | | | | | | | | | | | | | | | | | | | | | | | | |
|-----------------------------------|---------------------------------------|---|-----------------------------------|--------------|-----------|-----------|------------|------------|--------|------------|-----------------------------------|--------------|-----------------------------------|--------------|---------|------|------------|------------|-----------|-------|-----------|--------|------------|-------|---------|--------|---------|-------------|------|---------|----------|---------|--|--|
| 1 | Residual Resistance | Position the contact arm at the extreme counterclockwise limit of mechanical travel and measure the resistance between the contact arm and the corresponding end terminal. Then, position the contact arm at the extreme clockwise limit of mechanical travel and measure the resistance between the contact arm and the corresponding end terminal. During this test, take suitable precautions to ensure that the rated current of the resistance element is not exceeded. | | | | | | | | | | | | | | | | | | | | | | | | | | | | | | | | |
| 2 | Contact Resistance | <p>Contact resistance variation should be measured with the measuring circuit shown below, or its equivalent. The operating wiper should be rotated in both directions through 90% of the actual effective-electrical travel for a total of 6 cycles.</p> <p>The rate of rotation of the operating wiper should be such that the wiper completes 1 count in determining whether or not a contact resistance variation is observed at least twice in the same location. The test current should follow the value given in Table 2 unless otherwise limited by the power rating.</p> <p>• PVZ/PVA2</p> <table border="1" style="margin-left: 20px; border-collapse: collapse;"> <thead> <tr> <th style="width: 40%;">Standard Total Resistance R (ohm)</th> <th style="width: 60%;">Test Current</th> </tr> </thead> <tbody> <tr> <td>100≤R<10k</td> <td>20mA max.</td> </tr> <tr> <td>10k≤R<100k</td> <td>1mA max.</td> </tr> <tr> <td>100k≤R</td> <td>100μA max.</td> </tr> </tbody> </table> <p>• PVM4A□□□C01</p> <table border="1" style="margin-left: 20px; border-collapse: collapse;"> <thead> <tr> <th style="width: 15%;">Standard Total Resistance R (ohm)</th> <th style="width: 10%;">Test Current</th> <th style="width: 15%;">Standard Total Resistance R (ohm)</th> <th style="width: 10%;">Test Current</th> </tr> </thead> <tbody> <tr> <td>R≤100</td> <td>20mA</td> <td>50k≤R<200k</td> <td>200μA</td> </tr> <tr> <td>100<R<500</td> <td>10mA</td> <td>200k≤R<1M</td> <td>100μA</td> </tr> <tr> <td>500≤R<1k</td> <td>4mA</td> <td>1M≤R<2M</td> <td>50μA</td> </tr> <tr> <td>1k≤R<2k</td> <td>2mA</td> <td>2M≤R</td> <td>30μA</td> </tr> <tr> <td>2k≤R<50k</td> <td>1mA</td> <td></td> <td></td> </tr> </tbody> </table> <p style="text-align: center; margin-left: 20px;">Table 2: Test current for CRV</p> <div style="margin-left: 20px;"> <p style="text-align: center;">Figure 1: CRV measuring circuit</p> </div> | Standard Total Resistance R (ohm) | Test Current | 100≤R<10k | 20mA max. | 10k≤R<100k | 1mA max. | 100k≤R | 100μA max. | Standard Total Resistance R (ohm) | Test Current | Standard Total Resistance R (ohm) | Test Current | R≤100 | 20mA | 50k≤R<200k | 200μA | 100<R<500 | 10mA | 200k≤R<1M | 100μA | 500≤R<1k | 4mA | 1M≤R<2M | 50μA | 1k≤R<2k | 2mA | 2M≤R | 30μA | 2k≤R<50k | 1mA | | |
| Standard Total Resistance R (ohm) | Test Current | | | | | | | | | | | | | | | | | | | | | | | | | | | | | | | | | |
| 100≤R<10k | 20mA max. | | | | | | | | | | | | | | | | | | | | | | | | | | | | | | | | | |
| 10k≤R<100k | 1mA max. | | | | | | | | | | | | | | | | | | | | | | | | | | | | | | | | | |
| 100k≤R | 100μA max. | | | | | | | | | | | | | | | | | | | | | | | | | | | | | | | | | |
| Standard Total Resistance R (ohm) | Test Current | Standard Total Resistance R (ohm) | Test Current | | | | | | | | | | | | | | | | | | | | | | | | | | | | | | | |
| R≤100 | 20mA | 50k≤R<200k | 200μA | | | | | | | | | | | | | | | | | | | | | | | | | | | | | | | |
| 100<R<500 | 10mA | 200k≤R<1M | 100μA | | | | | | | | | | | | | | | | | | | | | | | | | | | | | | | |
| 500≤R<1k | 4mA | 1M≤R<2M | 50μA | | | | | | | | | | | | | | | | | | | | | | | | | | | | | | | |
| 1k≤R<2k | 2mA | 2M≤R | 30μA | | | | | | | | | | | | | | | | | | | | | | | | | | | | | | | |
| 2k≤R<50k | 1mA | | | | | | | | | | | | | | | | | | | | | | | | | | | | | | | | | |
| 3 | Humidity Exposure | The wiper contact point should be preset at about 50% position of effective rotational angle. After that, the potentiometer should be placed in a chamber at 40±2°C and 90 - 95% without loading for 500±12 hours. The resistance value should be measured after keeping the potentiometer in a room for 5±1/6 hours. | | | | | | | | | | | | | | | | | | | | | | | | | | | | | | | | |
| 4 | High Temperature Exposure | The wiper contact point should be preset at about 50% position of effective rotational angle. After that, the potentiometer should be placed in a chamber at 70±2°C without loading for 500±12 hours. The resistance value should be measured after keeping the potentiometer in a room for 1.5±1/6 hours. | | | | | | | | | | | | | | | | | | | | | | | | | | | | | | | | |
| 5 | Humidity Load Life | The wiper contact point should be preset at about 50% position of effective rotational angle. After that, the potentiometer should be placed in a chamber at 40±2°C and 90 - 95% with loading the 1/2 rated voltage between #1 and #2 terminals, intermittently 1.5 hours ON and 0.5 hours OFF for 1000±12 hours. The resistance value should be measured after keeping the potentiometer in a room for 5±1/6 hours. | | | | | | | | | | | | | | | | | | | | | | | | | | | | | | | | |
| 6 | Load Life | The wiper contact point should be preset at about 50% position of effective rotational angle. After that, the potentiometer should be placed in a chamber at 70±2°C (50±2°C for PVZ) with loading the 1/2 rated voltage between #1 and #2 terminals, intermittently 1.5 hours ON and 0.5 hours OFF for 1000±12 hours. The resistance value should be measured after keeping the potentiometer in a room for 1 to 2 hours. | | | | | | | | | | | | | | | | | | | | | | | | | | | | | | | | |
| 7 | Temperature Cycle | <p>The wiper contact point should be preset at about 50% position of effective rotational angle. After that, the potentiometer should be subjected to Table 3, Table 4 temperature for 5 cycles. The resistance value should be measured after keeping the potentiometer in a room for 1 to 2 hours.</p> <table border="1" style="margin-left: 20px; border-collapse: collapse;"> <thead> <tr> <th style="width: 10%;">Sequence</th> <th style="width: 10%;">1</th> <th style="width: 10%;">2</th> <th style="width: 10%;">3</th> <th style="width: 10%;">4</th> </tr> </thead> <tbody> <tr> <td>Temp. (°C)</td> <td>-25±3</td> <td>+25±2</td> <td>+85±3</td> <td>+25±2</td> </tr> <tr> <td>Time (min.)</td> <td>30±3</td> <td>10 max.</td> <td>30±3</td> <td>10 max.</td> </tr> </tbody> </table> <p style="text-align: center; margin-left: 20px;">Table 3: PVZ</p> <table border="1" style="margin-left: 20px; border-collapse: collapse;"> <thead> <tr> <th style="width: 10%;">Sequence</th> <th style="width: 10%;">1</th> <th style="width: 10%;">2</th> <th style="width: 10%;">3</th> <th style="width: 10%;">4</th> </tr> </thead> <tbody> <tr> <td>Temp. (°C)</td> <td>-55±3</td> <td>+25±2</td> <td>+125±3</td> <td>+25±2</td> </tr> <tr> <td>Time (min.)</td> <td>30±3</td> <td>10 max.</td> <td>30±3</td> <td>10 max.</td> </tr> </tbody> </table> <p style="text-align: center; margin-left: 20px;">Table 4: PVA2/PVM4A□□□C01</p> | Sequence | 1 | 2 | 3 | 4 | Temp. (°C) | -25±3 | +25±2 | +85±3 | +25±2 | Time (min.) | 30±3 | 10 max. | 30±3 | 10 max. | Sequence | 1 | 2 | 3 | 4 | Temp. (°C) | -55±3 | +25±2 | +125±3 | +25±2 | Time (min.) | 30±3 | 10 max. | 30±3 | 10 max. | | |
| Sequence | 1 | 2 | 3 | 4 | | | | | | | | | | | | | | | | | | | | | | | | | | | | | | |
| Temp. (°C) | -25±3 | +25±2 | +85±3 | +25±2 | | | | | | | | | | | | | | | | | | | | | | | | | | | | | | |
| Time (min.) | 30±3 | 10 max. | 30±3 | 10 max. | | | | | | | | | | | | | | | | | | | | | | | | | | | | | | |
| Sequence | 1 | 2 | 3 | 4 | | | | | | | | | | | | | | | | | | | | | | | | | | | | | | |
| Temp. (°C) | -55±3 | +25±2 | +125±3 | +25±2 | | | | | | | | | | | | | | | | | | | | | | | | | | | | | | |
| Time (min.) | 30±3 | 10 max. | 30±3 | 10 max. | | | | | | | | | | | | | | | | | | | | | | | | | | | | | | |
| 8 | Temperature Coefficient of Resistance | <p>The trimmer potentiometer should be subjected to each of the following temperatures (see Table 5, Table 6) for 30 to 40 minutes. The resistance value should be measured in the chamber.</p> $TCR = \frac{R_2 - R_1}{R_1 (T_2 - T_1)} \times 10^6 \text{ (ppm/°C)}$ <p style="margin-left: 20px;">T₁ : Reference temperature in degrees celsius R₁ : Resistance at reference temperature in ohm</p> <p style="margin-left: 20px;">T₂ : Test temperature in degrees celsius R₂ : Resistance at test temperature in ohm</p> <table border="1" style="margin-left: 20px; border-collapse: collapse;"> <thead> <tr> <th style="width: 10%;">Sequence</th> <th style="width: 10%;">1*</th> <th style="width: 10%;">2</th> <th style="width: 10%;">3*</th> <th style="width: 10%;">4</th> </tr> </thead> <tbody> <tr> <td>Temp. (°C)</td> <td>+25±2</td> <td>-25±3</td> <td>+25±2</td> <td>+85±3</td> </tr> </tbody> </table> <p style="text-align: center; margin-left: 20px;">Table 5: PVZ</p> <table border="1" style="margin-left: 20px; border-collapse: collapse;"> <thead> <tr> <th style="width: 10%;">Sequence</th> <th style="width: 10%;">1*</th> <th style="width: 10%;">2</th> <th style="width: 10%;">3*</th> <th style="width: 10%;">4</th> </tr> </thead> <tbody> <tr> <td>Temp. (°C)</td> <td>+25±2</td> <td>-55±3</td> <td>+25±2</td> <td>+125±3</td> </tr> </tbody> </table> <p style="text-align: center; margin-left: 20px;">Table 6: PVA2/PVM4A□□□C01</p> <p>Note*: Norm temp.</p> | Sequence | 1* | 2 | 3* | 4 | Temp. (°C) | +25±2 | -25±3 | +25±2 | +85±3 | Sequence | 1* | 2 | 3* | 4 | Temp. (°C) | +25±2 | -55±3 | +25±2 | +125±3 | | | | | | | | | | | | |
| Sequence | 1* | 2 | 3* | 4 | | | | | | | | | | | | | | | | | | | | | | | | | | | | | | |
| Temp. (°C) | +25±2 | -25±3 | +25±2 | +85±3 | | | | | | | | | | | | | | | | | | | | | | | | | | | | | | |
| Sequence | 1* | 2 | 3* | 4 | | | | | | | | | | | | | | | | | | | | | | | | | | | | | | |
| Temp. (°C) | +25±2 | -55±3 | +25±2 | +125±3 | | | | | | | | | | | | | | | | | | | | | | | | | | | | | | |
| 9 | Rotational Life | The wiper should be rotated over 90% of the effective rotational angle without loading at a speed of 10 cycles per minute, for 10 cycles continuously. The resistance value should be measured after keeping the potentiometer in a room for 10±5 minutes. | | | | | | | | | | | | | | | | | | | | | | | | | | | | | | | | |

SMD Sealed Type (PVG3/M4A_D01/G5)/Lead Sealed Type (PV32/12/37/36) Specifications and Test Methods

The following describes trimmer potentiometer testing conducted by Murata Manufacturing Co., Ltd. in accordance with MIL-R-22097 (military specification for variable resistors, non-wirewound) and MIL-STD-202 (test methods for electronic and electrical component parts).

| No. | Item | Test Methods | | | | | | | | | | | | | | | | | | | | |
|-----------------------------------|---------------------------------------|---|-----------------------------------|--------------------------|----------------------|----------------------------|-------------------|------|-------------------|------------------|---------------------|------|----------------------------|-------|---------------------|----------------------------|--------------------|-------|------------------|------|-------------|------|
| 1 | Total Resistance | <p>Measure total resistance between the resistance element and terminals (#1 and #3) with the contact arm positioned against a stop. The positioning of the contact arm and terminal should be the same for subsequent total resistance measurements on the same device. Use the test voltage specified in Table 1 for total resistance measurements. This voltage should be used for all subsequent total resistance measurements.</p> <table border="1" style="margin-left: auto; margin-right: auto; border-collapse: collapse;"> <thead> <tr style="background-color: #cccccc;"> <th style="text-align: center;">Total Resistance, Nominal (ohm)</th> <th style="text-align: center;">Maximum Test Voltage (V)</th> </tr> </thead> <tbody> <tr> <td style="text-align: center;">$10 \leq R \leq 100$</td> <td style="text-align: center;">1.0</td> </tr> <tr> <td style="text-align: center;">$100 < R \leq 1k$</td> <td style="text-align: center;">3.0</td> </tr> <tr> <td style="text-align: center;">$1k < R \leq 10k$</td> <td style="text-align: center;">10.0</td> </tr> <tr> <td style="text-align: center;">$10k < R \leq 100k$</td> <td style="text-align: center;">30.0</td> </tr> <tr> <td style="text-align: center;">$100k < R$</td> <td style="text-align: center;">100.0</td> </tr> </tbody> </table> <p style="text-align: center; margin-top: 5px;">Table 1: Total resistance test voltage</p> | Total Resistance, Nominal (ohm) | Maximum Test Voltage (V) | $10 \leq R \leq 100$ | 1.0 | $100 < R \leq 1k$ | 3.0 | $1k < R \leq 10k$ | 10.0 | $10k < R \leq 100k$ | 30.0 | $100k < R$ | 100.0 | | | | | | | | |
| Total Resistance, Nominal (ohm) | Maximum Test Voltage (V) | | | | | | | | | | | | | | | | | | | | | |
| $10 \leq R \leq 100$ | 1.0 | | | | | | | | | | | | | | | | | | | | | |
| $100 < R \leq 1k$ | 3.0 | | | | | | | | | | | | | | | | | | | | | |
| $1k < R \leq 10k$ | 10.0 | | | | | | | | | | | | | | | | | | | | | |
| $10k < R \leq 100k$ | 30.0 | | | | | | | | | | | | | | | | | | | | | |
| $100k < R$ | 100.0 | | | | | | | | | | | | | | | | | | | | | |
| 2 | Residual Resistance | <p>Position the contact arm at the extreme counterclockwise limit of mechanical travel and measure the resistance between the contact arm and the corresponding end terminal. Then, position the contact arm at the extreme clockwise limit of mechanical travel and measure the resistance between the contact arm and the corresponding end terminal. During this test, take suitable precautions to ensure that the rated current of the resistance element is not exceeded.</p> | | | | | | | | | | | | | | | | | | | | |
| 3 | Contact Resistance Variation | <p>Contact resistance variation should be measured with the measuring circuit shown in Figure 1, or its equivalent. The adjustment rotor (screw) should be rotated in both directions through 90% of the actual effective-electrical rotational angle (number of turns) for a total of 6 cycles. Only the last 3 cycles should count in determining whether or not a contact resistance variation is observed at least twice in the same location, exclusive of the roll-on or roll-off points where the contact arm moves from the termination, on or off, the resistance element. The rate of rotation of the adjustment rotor (screw) should be such that the adjustment rotor (screw) completes 1 cycle for 5 seconds minimum to 2 minutes maximum. The test current used should follow the value given in Table 2 unless otherwise limited by power rating.</p> <table border="1" style="margin-left: auto; margin-right: auto; border-collapse: collapse;"> <thead> <tr style="background-color: #cccccc;"> <th style="text-align: center;">Standard Total Resistance R (ohm)</th> <th style="text-align: center;">Test Current</th> </tr> </thead> <tbody> <tr> <td style="text-align: center;">$R \leq 100$</td> <td style="text-align: center;">20mA</td> </tr> <tr> <td style="text-align: center;">$100 < R < 500$</td> <td style="text-align: center;">10mA</td> </tr> <tr> <td style="text-align: center;">$500 \leq R < 1k$</td> <td style="text-align: center;">4mA</td> </tr> <tr> <td style="text-align: center;">$1k \leq R < 2k$</td> <td style="text-align: center;">2mA</td> </tr> <tr> <td style="text-align: center;">$2k \leq R < 50k$</td> <td style="text-align: center;">1mA</td> </tr> <tr> <td style="text-align: center;">$50k \leq R < 200k$</td> <td style="text-align: center;">200μA</td> </tr> <tr> <td style="text-align: center;">$200k \leq R < 1M$</td> <td style="text-align: center;">100μA</td> </tr> <tr> <td style="text-align: center;">$1M \leq R < 2M$</td> <td style="text-align: center;">50μA</td> </tr> <tr> <td style="text-align: center;">$2M \leq R$</td> <td style="text-align: center;">30μA</td> </tr> </tbody> </table> <p style="text-align: center; margin-top: 5px;">Table 2: Test current for CRV</p> <div style="text-align: right; margin-top: 10px;"> <p style="font-size: small; margin-top: 5px;">Rx : Trimmer Potentiometer Oscilloscope bandwidth :100Hz to 50kHz</p> <p style="text-align: center;">Figure 1: CRV measuring circuit</p> </div> | Standard Total Resistance R (ohm) | Test Current | $R \leq 100$ | 20mA | $100 < R < 500$ | 10mA | $500 \leq R < 1k$ | 4mA | $1k \leq R < 2k$ | 2mA | $2k \leq R < 50k$ | 1mA | $50k \leq R < 200k$ | 200μA | $200k \leq R < 1M$ | 100μA | $1M \leq R < 2M$ | 50μA | $2M \leq R$ | 30μA |
| Standard Total Resistance R (ohm) | Test Current | | | | | | | | | | | | | | | | | | | | | |
| $R \leq 100$ | 20mA | | | | | | | | | | | | | | | | | | | | | |
| $100 < R < 500$ | 10mA | | | | | | | | | | | | | | | | | | | | | |
| $500 \leq R < 1k$ | 4mA | | | | | | | | | | | | | | | | | | | | | |
| $1k \leq R < 2k$ | 2mA | | | | | | | | | | | | | | | | | | | | | |
| $2k \leq R < 50k$ | 1mA | | | | | | | | | | | | | | | | | | | | | |
| $50k \leq R < 200k$ | 200μA | | | | | | | | | | | | | | | | | | | | | |
| $200k \leq R < 1M$ | 100μA | | | | | | | | | | | | | | | | | | | | | |
| $1M \leq R < 2M$ | 50μA | | | | | | | | | | | | | | | | | | | | | |
| $2M \leq R$ | 30μA | | | | | | | | | | | | | | | | | | | | | |
| 4 | Temperature Coefficient of Resistance | <p>The trimmer potentiometer should be subjected to each of the following temperatures (see Table 3) for 30-45 minutes. Temperature coefficient of resistance should be applied to the following formula.</p> $TCR = \frac{R_2 - R_1}{R_1 (T_2 - T_1)} \times 10^6 \text{ (ppm/}^\circ\text{C)}$ <p style="margin-left: 20px;"> T_1 : Reference temperature in degrees celsius T_2 : Test temperature in degrees celsius R_1 : Resistance at reference temperature in ohm R_2 : Resistance at test temperature in ohm </p> <table border="1" style="margin-left: auto; margin-right: auto; border-collapse: collapse; width: 80%;"> <thead> <tr style="background-color: #cccccc;"> <th style="text-align: center;">Sequence</th> <th style="text-align: center;">1*</th> <th style="text-align: center;">2</th> <th style="text-align: center;">3</th> <th style="text-align: center;">4*</th> <th style="text-align: center;">5</th> <th style="text-align: center;">6</th> </tr> </thead> <tbody> <tr> <td style="text-align: center;">Temperature (°C)</td> <td style="text-align: center;">+25</td> <td style="text-align: center;">-15</td> <td style="text-align: center;">Min. operating Temperature</td> <td style="text-align: center;">+25</td> <td style="text-align: center;">+65</td> <td style="text-align: center;">Max. operating Temperature</td> </tr> </tbody> </table> <p style="font-size: x-small; margin-top: 5px;">Note*: Reference temperature</p> <p style="text-align: center; margin-top: 5px;">Table 3: Test temperatures</p> | Sequence | 1* | 2 | 3 | 4* | 5 | 6 | Temperature (°C) | +25 | -15 | Min. operating Temperature | +25 | +65 | Max. operating Temperature | | | | | | |
| Sequence | 1* | 2 | 3 | 4* | 5 | 6 | | | | | | | | | | | | | | | | |
| Temperature (°C) | +25 | -15 | Min. operating Temperature | +25 | +65 | Max. operating Temperature | | | | | | | | | | | | | | | | |
| 5 | Voltage Setting Stability | <p>The wiper should be set at approximately 40% of the actual effective-electrical rotational angle (number of turns). An adequate DC test potential should be applied between terminal #1 and terminal #3. The voltage between terminal #1 and terminal #3, and the voltage between terminal #1 and terminal #2, should be measured and applied to the following formula.</p> $\text{Voltage setting stability} = \left(\frac{e'}{E} - \frac{e}{E} \right) \times 100 \text{ (\%)}$ <p style="margin-left: 20px;"> e : Before test (The voltage between terminal #1 and terminal #2) e' : After test (The voltage between terminal #1 and terminal #2) </p> <div style="text-align: right; margin-top: 10px;"> <p style="text-align: center;">Figure 2</p> </div> | | | | | | | | | | | | | | | | | | | | |

Continued on the following page.

SMD Sealed Type (PVG3/M4A_D01/G5)/Lead Sealed Type (PV32/12/37/36) Specifications and Test Methods

Continued from the preceding page.

| No. | Item | Test Methods | | | | | | | | | | | | | | | |
|--------------------------|---|--|----------|--------|---|---|---|--------------------------|-------|-------|--------|-------|-------------|----|--------|----|--------|
| 6 | Temperature Cycle | <p>The trimmer potentiometer should be subjected to Table 4 temperature for 5 cycles. The trimmer potentiometer should be removed from the chamber, and maintained at a temperature of 25±5°C for 1-2 hours.</p> <table border="1" style="margin-left: auto; margin-right: auto; border-collapse: collapse;"> <thead> <tr style="background-color: #f2f2f2;"> <th style="text-align: left;">Sequence</th> <th style="text-align: center;">1</th> <th style="text-align: center;">2</th> <th style="text-align: center;">3</th> <th style="text-align: center;">4</th> </tr> </thead> <tbody> <tr> <td style="text-align: left;">Temp. (°C) PV□□ series</td> <td style="text-align: center;">-55±3</td> <td style="text-align: center;">+25±2</td> <td style="text-align: center;">+125±3</td> <td style="text-align: center;">+25±2</td> </tr> <tr> <td style="text-align: left;">Time (min.)</td> <td style="text-align: center;">30</td> <td style="text-align: center;">5 max.</td> <td style="text-align: center;">30</td> <td style="text-align: center;">5 max.</td> </tr> </tbody> </table> <p style="text-align: center;">Table 4: One cycle of temperature cycle.</p> | Sequence | 1 | 2 | 3 | 4 | Temp. (°C) PV□□ series | -55±3 | +25±2 | +125±3 | +25±2 | Time (min.) | 30 | 5 max. | 30 | 5 max. |
| Sequence | 1 | 2 | 3 | 4 | | | | | | | | | | | | | |
| Temp. (°C) PV□□ series | -55±3 | +25±2 | +125±3 | +25±2 | | | | | | | | | | | | | |
| Time (min.) | 30 | 5 max. | 30 | 5 max. | | | | | | | | | | | | | |
| 7 | Humidity | <p>1) PV12, PV32, PVM4A□□□D01 series The trimmer potentiometer should be placed in a chamber at a temperature of 40±2°C and a humidity of 90-95% without loading for 250±8 hours (500±12 hours for PVM4A□□□D01 series). The trimmer potentiometer should be removed from the chamber, and maintained at a temperature of 25±5°C for 5±1/6 hours.</p> <p>2) PVG3, PVG5, PV36, PV37 series The trimmer potentiometer should be subjected to the programmed humidity environment for 10 cycle (see Figure 3). The trimmer potentiometer should be removed from the chamber, and maintained at a temperature of 25±5°C for 1.5±1/2 hours.</p> <div style="text-align: right; font-size: small; margin-bottom: 5px;">MIL-STD-202 METHOD 106</div> <p style="text-align: center;">Figure 3</p> | | | | | | | | | | | | | | | |
| 8 | Vibration | <p>1) PV□□ series The trimmer potentiometer should be vibrated throughout the frequency range at the 20G level. A complete frequency range, 10Hz to 2000Hz and back, should be made within 15 minutes for a total of 4 sweeps in each of the three axis directions for a total of 12 sweeps.</p> | | | | | | | | | | | | | | | |
| 9 | Shock | <p>1) PV□□ series The trimmer potentiometer should be shocked at the 100G level and should be subjected to 4 shocks in each of the three axis directions for a total of 12 shocks.</p> <p>2) PVM4A□□□D01 series The trimmer potentiometer should be shocked at the 100G level and should be subjected to 3 shocks in each of the six axis directions for a total of 18 shocks.</p> | | | | | | | | | | | | | | | |
| 10 | Temperature Load Life | <p>Full rated continuous working voltage not exceeding the maximum rated voltage should be applied intermittently between terminal #1 and terminal #3 of the trimmer potentiometer, 1.5 hours on and 0.5 hours off, for a total of 1000±12 hours, at a temperature of 70±2°C (85±2°C for PV37 series). The trimmer potentiometer should be removed from the chamber, and maintained at a temperature of 25±5°C for 1 to 2 hours.</p> | | | | | | | | | | | | | | | |
| 11 | High Temperature Exposure | <p>The trimmer potentiometer should be placed in a chamber at a temperature of 125±3°C 250±8 hours without loading. The trimmer potentiometer should be removed from the chamber, and maintained at a temperature of 25±5°C for 1 to 2 hours.</p> | | | | | | | | | | | | | | | |
| 12 | Low Temperature Exposure (Except for PVM4A□□□D01) | <p>The trimmer potentiometer should be placed in a chamber at a temperature of -55±3°C for 1 hours without loading. Full rated continuous working voltage not exceeding the maximum rated voltage should be applied for 45 minutes. The trimmer potentiometer should be removed from the chamber, and maintained at a temperature of 25±5°C for approximately 24 hours.</p> | | | | | | | | | | | | | | | |
| 13 | Low Temperature Operation (Only for PVM4A□□□D01) | <p>The trimmer potentiometer should be placed in a chamber at a temperature of -25±3°C (-55±3°C for PVM4A□□□D01 series) 48±4 hours without loading. The trimmer potentiometer should be removed from the chamber, and maintained at a temperature of 25±5°C for 1-2 hours.</p> | | | | | | | | | | | | | | | |

Continued on the following page. ↗

SMD Sealed Type (PVG3/M4A_D01/G5)/Lead Sealed Type (PV32/12/37/36) Specifications and Test Methods

Continued from the preceding page.

| No. | Item | Test Methods |
|-----|-----------------|---|
| 14 | Rotational Life | <p>1) PV□□ series Full rated continuous working voltage not exceeding the maximum rated voltage should be applied with the circuit shown in the figure. The adjustment rotor (screw) should be continuously cycled through not less than 90% of effective-electrical rotational angle (number of turns), at the rate of 1 cycle for 5 seconds minimum to 2.5 minutes maximum for total of 200 cycles.</p>  <p style="text-align: center;">Figure 4</p> <p>2) PVG3, PVG5 series The adjustment rotor (screw) should be continuously cycled though not less than 90% of effective-electrical rotational angle (number of turns), at the rate of 1 cycle for 5 seconds minimum to 2.5 minutes maximum for a total of 50 (100 for PVG5) cycles, without loading.</p> <p>3) PVM4A□□□D01 series The wiper should be rotated over 90% of the effective rotational angle without loading at a speed of 10 cycles per minute, for 100 cycles continuously.</p> |

Packaging

Minimum Quantity

| Part Number | Minimum Quantity (pcs.) | |
|-------------|-------------------------|------|
| | ø180mm reel | Bulk |
| PVZ2A | 3000 | 1000 |
| PVZ2R | 3000 | 1000 |
| PVA2 | 3000 | 1000 |
| PVZ3A/H | 2000 | 1000 |
| PVZ3G | 2500 | 1000 |
| PVZ3K | 1500 | 1000 |
| PVG3A/G | 1000 | 500 |
| PVM4 | 500 | 500 |
| PVG5A | 250 | 100 |
| PVG5H | 500 | 100 |
| PV32 | — | 100 |
| PV12 | — | 50 |
| PV36 | — | 100 |
| PV37 | — | 100 |

Dimensions of Reel

PVZ2A/PVA2/PVZ3A/PVZ3G/PVZ3H



(in mm)

PVZ2R/PVZ3K/PVM4/PVG3/PVG5H



(in mm)

PVG5A



(in mm)

Continued on the following page.

Packaging

Continued from the preceding page.

Dimensions of Plastic Tape

PVZ2 / PVA2 / PVZ3

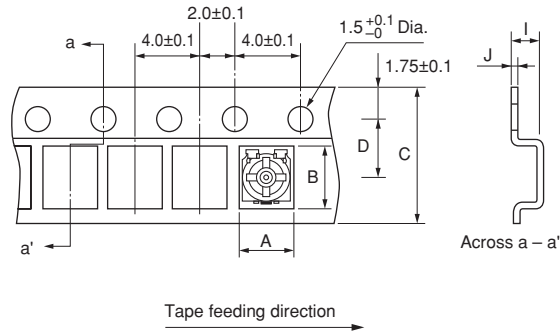

| Part Number | A | B | C | D | I | J |
|-------------|---------|----------|----------|---------|---------|---------|
| PVZ2A | 2.4±0.2 | 3.1±0.1 | 8.0±0.2 | 3.5±0.1 | 1.1±0.1 | 0.2±0.1 |
| PVZ2R | | 5.1±0.2 | 12.0±0.2 | 5.5±0.1 | 1.0±0.1 | 0.3±0.1 |
| PVA2 | | 3.1±0.1 | 8.0±0.2 | 3.5±0.1 | 1.1±0.1 | 0.2±0.1 |
| PVZ3A/H | 3.8±0.2 | 1.95±0.1 | | | | |
| PVZ3G | 3.3±0.2 | 3.8±0.2 | 8.0±0.2 | 3.5±0.1 | 1.3±0.1 | 0.3±0.1 |
| PVZ3K | | | | | 5.8±0.2 | |

• The side containing terminals #1 and #3 faces the plastic tape pilot holes.

(in mm)

Dimensions of Plastic Tape

PVG3A / PVG3G / PVM4 / PVG5H



| Part Number | A | B | I | J |
|-------------|---------|---------|----------|---------|
| PVG3A | 4.0±0.1 | 4.0±0.1 | 2.1±0.1 | 0.3±0.1 |
| PVG3G | | 4.9±0.1 | | |
| PVM4 | 4.5±0.2 | 5.5±0.2 | 2.15±0.1 | 0.3±0.1 |
| PVG5H | 5.4±0.2 | 5.8±0.2 | 4.0±0.1 | 0.4±0.1 |

• The side containing terminals #1 and #3 faces the plastic tape pilot holes (except PVG3).

(in mm)

Continued on the following page. ↗

Packaging

☐ Continued from the preceding page.

■ Dimensions of Plastic Tape



Recommended Adjustment Tools/Qualified Standards

■ Recommended Adjustment Tools

| Trimmer Potentiometer Series | Manufacturers | Model Number | MURATA Model Number | Blade |
|------------------------------|------------------------|----------------|---------------------|----------------------|
| PVZ2/PVA2 | MURATA MFG. | KMDR190 | KMDR190 | + Cross |
| PVZ3G | VESSEL MFG. | No.9000+1.7×30 | KMDR080 | + Cross |
| PVZ3A/PVZ3H/PVG3 | TORAY INDUSTRIES, INC. | SA-2225 | KMDR070 | – Minus (round edge) |
| PVM4 | VESSEL MFG. | No.9000–2.6×30 | KMDR120 | – Minus |
| PVG5 | VESSEL MFG. | No.9000–1.3×30 | KMDR130 | – Minus |
| others | VESSEL MFG. | No.9000–1.8×30 | KMDR110 | – Minus |

■ For Automatic Adjustment

| Trimmer Potentiometer Series | Manufacturers | Model Number | MURATA Model Number | Blade |
|------------------------------|-----------------------|--------------|---------------------|----------------------|
| PVZ3 PVG3 | TORAY INDUSTRIES, INC | JB-2225 | KMBT070 | – Minus (round edge) |

■ Qualified Standards

The products listed here have been produced by the ISO9001 and ISO/TS16949 certified factory.

| MURATA FACTORY | Qualified Date | Standard | Qualified Number |
|----------------------------------|----------------|--------------------------------|------------------|
| Wuxi Murata Electronics Co.,Ltd. | May 12, 1999 | UNDERWRITERS LABORATORIES INC. | A7924 |

* No ODCs (Ozone Depleting Chemicals) are used on all Murata's trimmer potentiometers.

⚠Note:

1. Export Control

<For customers outside Japan>

No Murata products should be used or sold, through any channels, for use in the design, development, production, utilization, maintenance or operation of, or otherwise contribution to (1) any weapons (Weapons of Mass Destruction [nuclear, chemical or biological weapons or missiles] or conventional weapons) or (2) goods or systems specially designed or intended for military end-use or utilization by military end-users.

<For customers in Japan>

For products which are controlled items subject to the "Foreign Exchange and Foreign Trade Law" of Japan, the export license specified by the law is required for export.

2. Please contact our sales representatives or product engineers before using the products in this catalog for the applications listed below, which require especially high reliability for the prevention of defects which might directly damage a third party's life, body or property, or when one of our products is intended for use in applications other than those specified in this catalog.

- | | |
|-----------------------------|--|
| ① Aircraft equipment | ② Aerospace equipment |
| ③ Undersea equipment | ④ Power plant equipment |
| ⑤ Medical equipment | ⑥ Transportation equipment (vehicles, trains, ships, etc.) |
| ⑦ Traffic signal equipment | ⑧ Disaster prevention / crime prevention equipment |
| ⑨ Data-processing equipment | ⑩ Application of similar complexity and/or reliability requirements to the applications listed above |

3. Product specifications in this catalog are as of May 2012. They are subject to change or our products in it may be discontinued without advance notice. Please check with our sales representatives or product engineers before ordering. If there are any questions, please contact our sales representatives or product engineers.
4. Please read rating and ⚠CAUTION (for storage, operating, rating, soldering, mounting and handling) in this catalog to prevent smoking and/or burning, etc.
5. This catalog has only typical specifications. Therefore, please approve our product specifications or transact the approval sheet for product specifications before ordering.
6. Please note that unless otherwise specified, we shall assume no responsibility whatsoever for any conflict or dispute that may occur in connection with the effect of our and/or a third party's intellectual property rights and other related rights in consideration of your use of our products and/or information described or contained in our catalogs. In this connection, no representation shall be made to the effect that any third parties are authorized to use the rights mentioned above under licenses without our consent.
7. No ozone depleting substances (ODS) under the Montreal Protocol are used in our manufacturing process.



Компания «ЭлектроПласт» предлагает заключение долгосрочных отношений при поставках импортных электронных компонентов на взаимовыгодных условиях!

Наши преимущества:

- Оперативные поставки широкого спектра электронных компонентов отечественного и импортного производства напрямую от производителей и с крупнейших мировых складов;
- Поставка более 17-ти миллионов наименований электронных компонентов;
- Поставка сложных, дефицитных, либо снятых с производства позиций;
- Оперативные сроки поставки под заказ (от 5 рабочих дней);
- Экспресс доставка в любую точку России;
- Техническая поддержка проекта, помощь в подборе аналогов, поставка прототипов;
- Система менеджмента качества сертифицирована по Международному стандарту ISO 9001;
- Лицензия ФСБ на осуществление работ с использованием сведений, составляющих государственную тайну;
- Поставка специализированных компонентов (Xilinx, Altera, Analog Devices, Intersil, Interpoint, Microsemi, Aeroflex, Peregrine, Syfer, Eurofarad, Texas Instrument, Miteq, Cobham, E2V, MA-COM, Hittite, Mini-Circuits, General Dynamics и др.);

Помимо этого, одним из направлений компании «ЭлектроПласт» является направление «Источники питания». Мы предлагаем Вам помощь Конструкторского отдела:

- Подбор оптимального решения, техническое обоснование при выборе компонента;
- Подбор аналогов;
- Консультации по применению компонента;
- Поставка образцов и прототипов;
- Техническая поддержка проекта;
- Защита от снятия компонента с производства.



Как с нами связаться

Телефон: 8 (812) 309 58 32 (многоканальный)

Факс: 8 (812) 320-02-42

Электронная почта: org@eplast1.ru

Адрес: 198099, г. Санкт-Петербург, ул. Калинина, дом 2, корпус 4, литера А.