

### DESCRIPTION

The MP2636 is a highly-integrated, flexible switch-mode battery charger with system power path management, designed for single-cell Li-ion or Li-Polymer batteries used in a wide range of portable applications.

The MP2636 can operate in both charge mode and boost mode to allow full system management and battery power management.

When input power is present, the device operates in charge mode. It automatically detects the battery voltage and charges the battery in three phases: trickle current, constant current and constant voltage. Other features include charge termination and auto-recharge. This device also integrates both input current limit and input voltage regulation in order to manage input power and meet the priority of the system power demand.

In the absence of an input source, the MP2636 switches to boost mode through the MODE pin to power the SYS pins from the battery. The OLIM pin programs the output current limit in boost mode. The MP2636 also allows an output short circuit protection to completely disconnect the battery from the load in the event of a short circuit fault. Normal operation will recover as soon as the short circuit fault is removed. The MP2636 provides full operating status indication to distinguish charge mode from boost mode. In addition, the MP2636 can report the real battery current in both charge and boost mode via IB pin.

The MP2636 achieves good EMI/EMC performance with well controlled switching edges.

To guarantee safe operation, the MP2636 limits the die temperature to a preset value of 120°C. Other safety features include input over-voltage protection, battery over-voltage protection, thermal shutdown, battery temperature monitoring, and a programmable timer to prevent prolonged charging of a dead battery.

### FEATURES

- Up to 16V Sustainable Input Voltage
- 4.5V-to-6V Operation Voltage Range
- Power Management Function, Integrated Input-Current Limit, Input Voltage Regulation
- Up to 3.0A Programmable Charge Current
- Trickle-Charge Function
- Analog Voltage Output IB pin for Battery Current Monitor
- Selectable 4.2V / 4.3V / 4.35V Charge Voltage with 0.5% Accuracy
- Negative Temperature Coefficient Pin for Temperature Monitoring
- Programmable Timer Back-up Protection
- Thermal Regulation and Thermal Shutdown
- Internal Battery Reverse Leakage Blocking
- Integrated Over Current Protection and Over Voltage Protection for Pass-through Path
- Reverse Boost Operation Mode for System Power
- Up to 3.0A Programmable Output Current Limit for Boost Mode
- Integrated Short Circuit Protection and Output Over Voltage Protection for Boost Mode

### APPLICATIONS

- Sub-Battery Applications
- Power-bank Applications for Smart-Phone, Tablet and Other Portable Devices

All MPS parts are lead-free and adhere to the RoHS directive. For MPS green status, please visit MPS website under Products, Quality Assurance page.

"MPS" and "The Future of Analog IC Technology" are registered trademarks of Monolithic Power Systems, Inc.

## TYPICAL APPLICATION

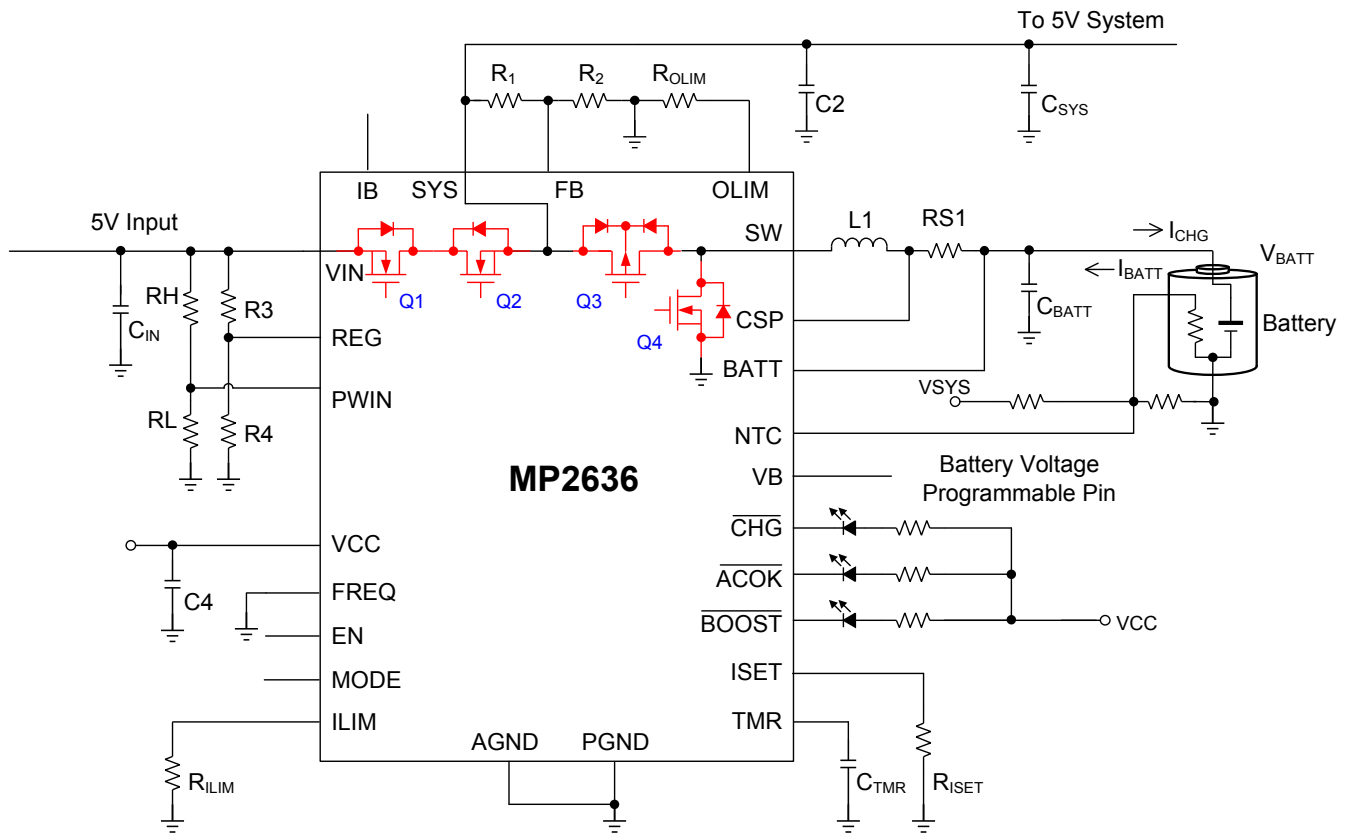

**Table 1: Operation Mode**

Power Source		MODE	EN	Operating Mode	ACOK	Q1,Q2	Q3	Q4
VIN	PWIN							
$V_{BATT}+300mV < V_{IN} < 6V$	PWIN>0.8V	X	Low	Only Pass Through Mode	Low	On	Off	Off
			High	Charging Mode		On	SW	SW
$V_{IN} < V_{BATT}+300mV$	X	High	X	Boost Discharge Mode	High	Off	SW	SW
X	PWIN<0.8V							
X	PWIN<0.8V	Low	X	SYS Force-off Mode	High	Off	Off	Off
$V_{IN} > 6V$	X			Input OVP				
$V_{IN} < 2V$	X			Sleep Mode				

X=Don't Care.

On = Fully Turn On

Off = Fully Off

SW = Switching

### ORDERING INFORMATION

Part Number	Package	Top Marking
MP2636GR	QFN-30 (4mmx4mm)	See Below

\* For Tape & Reel, add suffix –Z (e.g. MP2636GR–Z)

### TOP MARKING

**MPSYWW**

**MP2636**

**LLLLLL**

MPS: MPS prefix;  
 Y: year code;  
 WW: week code;  
 MP2636: part number;  
 LLLLLL: lot number;

### PACKAGE REFERENCE

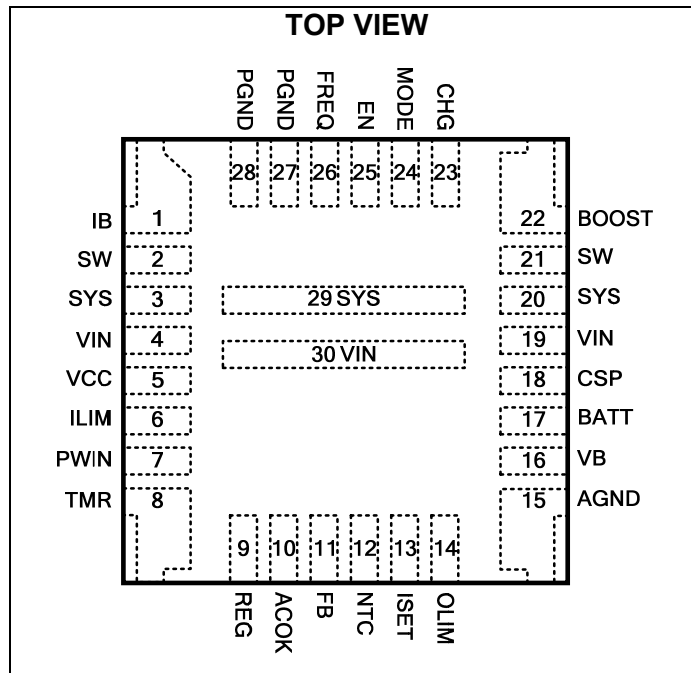

**ABSOLUTE MAXIMUM RATINGS** <sup>(1)</sup>

VIN to PGND .....	-0.3V to +20V
SYS to PGND .....	-0.3V to +6.5V
SW to PGND .....	-0.3V (-2V for 20ns)
.....	To + 6.5V (8.8V for 20ns)
BATT to PGND .....	-0.3V to +5V
<b>ACOK, CHG, BOOST to AGND</b>	
.....	-0.3V to +6.5V
All Other Pins to AGND.....	-0.3V to +6.5V
Continuous Power Dissipation (T <sub>A</sub> =+25°C) <sup>(2)</sup>	
.....	2.97W
Junction Temperature .....	150°C
Lead Temperature .....	260°C
Storage Temperature.....	-65°C to +150°C

**Recommended Operating Conditions** <sup>(3)</sup>

Supply Voltage VIN.....	4.5V to 6V
Battery Voltage BATT .....	2.5V to 4.35V
Operating Junction Temp (T <sub>J</sub> )..	-40°C to +125°C

<b>Thermal Resistance</b> <sup>(4)</sup>	<b>θ<sub>JA</sub></b>	<b>θ<sub>JC</sub></b>	
QFN-30 (4mmx4mm).....	42	9	°C/W

**Notes:**

- 1) Exceeding these ratings may damage the device.
- 2) The maximum allowable power dissipation is a function of the maximum junction temperature T<sub>J</sub> (MAX), the junction-to-ambient thermal resistance θ<sub>JA</sub>, and the ambient temperature T<sub>A</sub>. The maximum allowable continuous power dissipation at any ambient temperature is calculated by P<sub>D</sub> (MAX) = (T<sub>J</sub> (MAX)-T<sub>A</sub>)/θ<sub>JA</sub>. Exceeding the maximum allowable power dissipation will cause excessive die temperature, and the regulator will go into thermal shutdown. Internal thermal shutdown circuitry protects the device from permanent damage.
- 3) The device is not guaranteed to function outside of its operating conditions.
- 4) Measured on JESD51-7, 4-layer PCB.

## ELECTRICAL CHARACTERISTICS

$V_{IN} = 5V$ ,  $T_A = +25^{\circ}C$ , unless otherwise noted.

Parameters	Symbol	Condition	Min	Typ	Max	Units
IN to SYS NMOS On Resistance	$R_{IN\ to\ SYS}$			30		m $\Omega$
High-side PMOS On Resistance	$R_{H\_DS}$			25		m $\Omega$
Low-side NMOS On Resistance	$R_{L\_DS}$			25		m $\Omega$
Peak Current Limit for High-side PMOS	$I_{PEAK\_HS}$	Charger CC Mode/ Boost Mode		8		A
		Charger TC Mode		4		
Peak Current Limit for Low-side NMOS	$I_{PEAK\_LS}$	Boost Mode		5.5		A
Operating Frequency	$F_{SW}$	FREQ=LOW		600		kHz
VCC UVLO	$V_{CC\_UVLO}$		2	2.2	2.4	V
VCC UVLO Hysteresis				85		mV
PWIN Threshold	$V_{PWIN\_L}$		0.75	0.8	0.85	V
PWIN Threshold Hysteresis				45		mV
<b>Charge Mode</b>						
Input Quiescent Current	$I_{IN}$	EN=4V, BATT Float			2.5	mA
		EN=0V,			1.5	
Trickle Charge Current	$I_{TC}$	RS1 = 20m $\Omega$ , R <sub>ISSET</sub> < 60k, as percentage of I <sub>CC</sub>		10		%
Minimum Trickle Charge Current	$I_{TC\_MIN}$	RS1 = 20m $\Omega$ , R <sub>ISSET</sub> >= 60k		200		mA
Trickle Charge Voltage Threshold	$V_{BATT\_TC}$	Connect VB to GND	2.91	3.01	3.112	V
		Leave VB floating	2.94	3.043	3.145	
		Connect VB to High Logic	2.84	2.94	3.04	
Trickle Charge Hysteresis		$V_{BATT}$ falling		240		mV
Constant Charge (CC) Current	$I_{CC}$	RS1 = 20m $\Omega$ , R <sub>ISSET</sub> = 60.4k	1725	1987	2250	mA
		RS1 = 20m $\Omega$ , R <sub>ISSET</sub> = 47.5k	2225	2525	2825	
Termination Charge Current	$I_{BF}$	I <sub>CHG</sub> falling		150		mA
Terminal Battery Voltage	$V_{BATT\_FULL}$	Connect VB to GND	4.278	4.3	4.321	V
		Leave VB floating	4.328	4.35	4.371	
		Connect to VCC	4.179	4.2	4.221	
Recharge Threshold	$V_{RECH}$	Connect VB to GND	4.023	4.085	4.147	V
		Leave VB floating	4.07	4.132	4.195	
		Connect to VCC	3.93	3.99	4.05	

**ELECTRICAL CHARACTERISTICS** *(continued)*
 $V_{IN} = 5V$ ,  $T_A = +25^{\circ}C$ , unless otherwise noted.

Parameters	Symbol	Condition	Min	Typ	Max	Units
Recharge Threshold Hysteresis		Connect VB to GND		200		mV
		Leave VB floating		200		
		Connect to VCC		200		
Battery Over Voltage Threshold		As percentage of $V_{BATT\_FULL}$		102.5		%
<b>Input Voltage and Input Current Based Power Path</b>						
Input Voltage Regulation Reference	$V_{REG}$		1.18	1.2	1.22	V
Input Current Limit	$I_{IN\_LMT}$	$R_{ILIM} = 86.6k$	380	450	500	mA
		$R_{ILIM} = 51k$	720	810	900	
		$R_{ILIM} = 13k$	2940	3270	3600	
Input Over Current Threshold	$I_{IN\_OCP}$	$R_{ILIM} = 86.6k$		593		mA
		$R_{ILIM} = 51k$		1000		mA
		$R_{ILIM} = 13k^{(5)}$		4.09		A
Input Over Current Shutdown Blanking Time <sup>(5)</sup>	$T_{INOCBLK}$			120		$\mu s$
Input Over Current Shutdown Recover Time <sup>(5)</sup>	$T_{INRECVR}$			100		ms
<b>Boost Mode</b>						
SYS Voltage Range			4.2		6	V
Feedback Voltage			1.18	1.2	1.22	V
Feedback Input Current		$V_{FB}=1V$			200	nA
SYS Over Voltage Protection Threshold for Boost	$V_{SYS(OVP)}$	Threshold over $V_{SYS}$ to turn off the converter during boost mode	5.8	6	6.2	V
SYS Over Voltage Protection Threshold Hysteresis		$V_{SYS}$ falling from $V_{SYS(OVP)}$		125		mV
Boost Quiescent Current		$I_{SYS} = 0$ , $V_{SYS} = 5V$ , $V_{FB} = 2.0V$ , MODE = high, BATT = 4.2V		430	500	$\mu A$

**ELECTRICAL CHARACTERISTICS** *(continued)*
 $V_{IN} = 5V$ ,  $T_A = +25^{\circ}C$ , unless otherwise noted.

Parameters	Symbol	Condition	Min	Typ	Max	Units
Programmable Boost Output Current Limit Accuracy	$I_{OLIM}$	$V_{SYS} = 5V$ , $R_{S1} = 20m$ , $R_{OLIM} = 120k$	774	910	1046	mA
		$V_{SYS}=5V$ , $R_{S1} =20m$ , $R_{OLIM} = 47.5k$	2088	2320	2552	
SYS Over Current Blanking Time <sup>(5)</sup>	$T_{SYSOCBLK}$			120		$\mu s$
SYS Over Current Recover Time <sup>(5)</sup>	$T_{SYSRECVR}$			1.5		ms
Weak Battery Threshold	$V_{BATT(LOW)}$	During boosting		2.5		V
		Before Boost starts		2.9	3.05	
<b>Sleep Mode</b>						
Battery Leakage Current	$I_{BATT}$	$V_{BATT}=4.2V$ , SYS Float, $V_{IN}=GND$ , MODE=0V			40	$\mu A$
<b>Indication &amp; Logic</b>						
ACOK, CHG, BOOST pin output low voltage		Sinking 1.5mA			450	mV
ACOK, CHG, BOOST pin leakage current		Connected to 5V			1	$\mu A$
NTC and Time-out Fault Blinking Frequency <sup>(5)</sup>		$C_{TMR} = 0.1\mu F$ , $I_{CHG} = 1A$		13.7		Hz
EN, MODE Input Logic Low Voltage					0.4	V
EN, MODE Input High Voltage			1.4			V
FREQ Input Logic Low Voltage					0.8	V
FREQ Input Logic High Voltage			1.8			V
VB Input Logic Low Voltage					0.8	V
VB Input Logic High Voltage			1.8			V
IB Voltage Output		$I_{CHG}=1A$ in charge mode		0.36		V
		$I_{DIS}=1A$ in boost mode		0.40		V
<b>Protection</b>						
Trickle Charge Time		$C_{TMR}=0.1\mu F$ , Stay in TC Mode, $I_{CHG}= 2A$		17		Mins
Total Charge Time		$C_{TMR}=0.1\mu F$ , $I_{CHG}= 2.5A$		140		Mins



**ELECTRICAL CHARACTERISTICS** *(continued)*

V<sub>IN</sub> = 5V, T<sub>A</sub> = +25°C, unless otherwise noted.

Parameters	Symbol	Condition	Min	Typ	Max	Units
NTC Low Temp Rising Threshold		R <sub>NTC</sub> =NCP18XH103(0°C)	65.6%	66.6%	67.6%	V <sub>CC</sub>
NTC Low Temp Rising Threshold Hysteresis				1%		
NTC High Temp Rising Threshold		R <sub>NTC</sub> =NCP18XH103(50°C)	34%	35%	36%	V <sub>CC</sub>
NTC Low Temp Rising Threshold Hysteresis				1%		
Charging Current Fold-back Threshold <sup>(5)</sup>		Charge Mode		120		°C
Thermal Shutdown Threshold <sup>(5)</sup>				150		°C

**Notes:**

5) Guaranteed by Design

## PIN FUNCTIONS

Pin #	Name	Description
1	IB	Charge Current Represent. The voltage at this pin indicates the charge current to the battery in charge mode and discharge current out of the battery in boost mode.
2, 21	SW	Switch Output Node. It is recommended not to place Via's on the SW plane during PCB layout.
3, 20, 29	SYS	System Output. <b>A minimum of 22<math>\mu</math>F ceramic cap is required to be put as close as possible to the SYS and PGND pins. Total capacitance should NOT be lower than 44<math>\mu</math>F.</b>
4, 19, 30	VIN	Adapter Input. Place a bypass capacitor close to this pin to prevent large voltage spikes.
5	VCC	Internal Circuit Power Supply. Bypass this pin to GND with a 100nF ceramic capacitor. <b>This Pin CANNOT carry any external load.</b>
6	ILIM	Input Current Set. Connect to GND with an external resistor to program input current limit in charge mode.
7	PWIN	Input pin to detect the presence of valid input power. Pulling this pin to GND will turn off the IN-to-SYS pass through MOSFET.
8	TMR	Oscillator Period Timer. Connect a timing capacitor between this pin and GND to set the oscillator period for charge timer. Short to GND to disable the Timer function.
9	REG	Input voltage feedback for the input voltage regulation loop. Connect to tap of an external resistor divider from VIN to GND to program the input voltage regulation. Once the voltage at REG pin drops to the inner threshold, the charge current is reduced to maintain the input voltage at the regulation value.
10	ACOK	Valid Input Supply Indicator. Logic LOW at this pin indicates the presence of a valid power supply.
11	FB	System Voltage Feedback Input.
12	NTC	Negative Temperature Coefficient (NTC) Thermistor
13	ISET	Charge Current Set. Connect an external resistor to GND to program the charge current.
14	OLIM	Programmable Output-Current Limit for Boost mode. Connect an external resistor to GND to program the system current in Boost mode.
15	AGND	Analog Ground
16	VB	Programmable Battery-Full Voltage. Connect to GND for 4.3V, leave floating to 4.35V, and connect to logic HIGH for 4.2V.
17	BATT	Positive Battery Terminal / Battery Charge Current Sense Negative Input.
18	CSP	Battery Charge Current Sense Positive Input.
22	BOOST	Boost operation indicator. Logic LOW indicates boost operation. The pin becomes an open drain when the part operates at charge mode or sleep mode.
23	CHG	Charging Completion Indicator. Logic LOW indicates charge mode. The pin becomes an open drain once the charging has completed or is suspended.
24	MODE	Mode Select. Logic HIGH→boost mode. Logic LOW→sleep mode. Active only when $\overline{\text{ACOK}}$ is high (Input power is not available).

**PIN FUNCTIONS** *(continued)*

Pin #	Name	Description
25	EN	Charging Control Input. Logic HIGH enables charging. Logic LOW disables charging. Active only when $\overline{\text{ACOK}}$ is low (Input power is Ok)
26	FREQ	Connect to GND to figure the operating frequency to 600kHz.
27, 28	PGND	Power Ground.

## TYPICAL CHARACTERISTICS

$V_{IN} = 5V$ ,  $C_{IN} = C_{BATT} = C_{SYS} = C2 = 22\mu F$ ,  $L1 = 1.5\mu H$ ,  $RS1 = 20m\Omega$ ,  $C4 = C_{TMR} = 0.1\mu F$ , Battery Simulator, unless otherwise noted.

**Programmable Charge Current, Charge Mode**

$V_{IN}=5V$ ,  $V_{BATT\_FULL}=4.2V$ ,  
 $V_{BATT}=3.7V$ ,  $F_{SW}=600k$

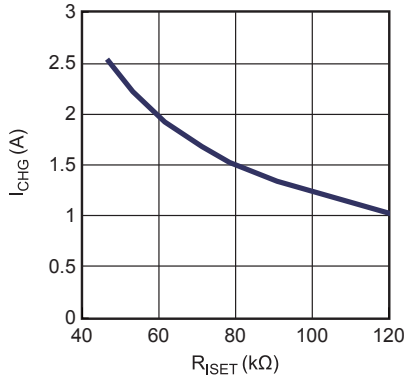

**Programmable Input Current Limit, Charge Mode**

$V_{IN}=5V$ ,  $V_{BATT\_FULL}=4.2V$ ,  
 $V_{BATT}=3.7V$ ,  $F_{SW}=600k$

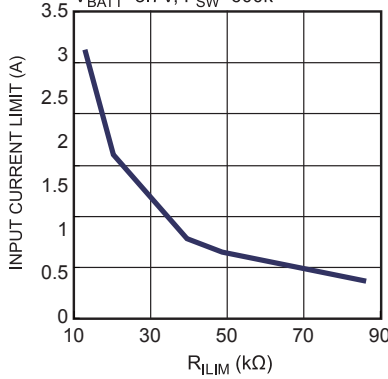

**Battery Leakage Current, Sleep Mode**

MODE=Low

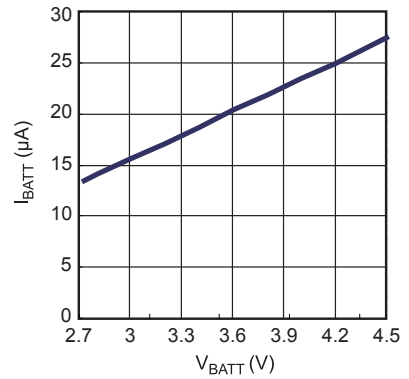

**Programmable Output Current Limit, Boost Mode**

$F_{SW}=600k$ ,  $V_{SYS}=5V$

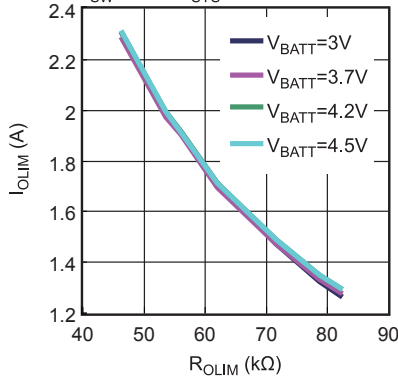

**Programmable Output Current Limit vs. Battery**

$R_{OLIM}=53.6k\Omega$ ,  $V_{SYS}=5V$

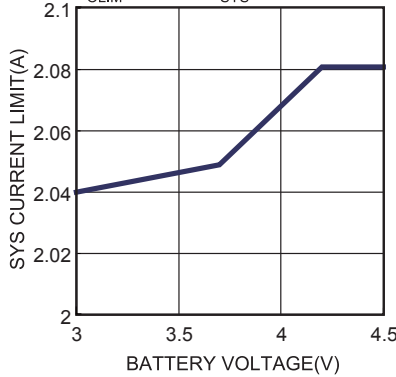

**VCC @ Charge Mode**

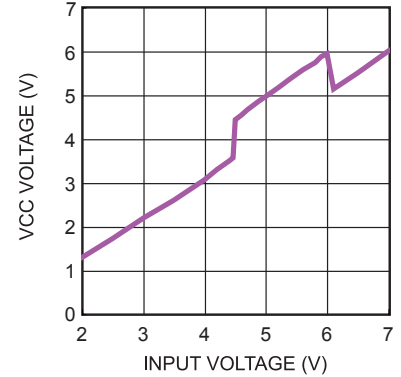

**VCC @ Boost Mode**

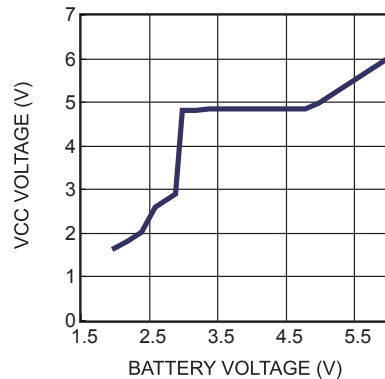

**IB Voltage vs. Battery Current @ Boost Mode**

$V_{SYS}=5V$ ,  $V_{BATT}=3.7V$ ,  $F_{SW}=600kHz$

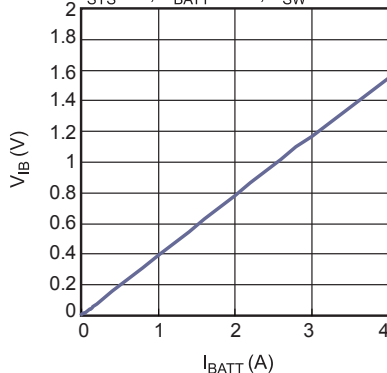

**Accuracy of the IB Monitor @ Boost Mode**

$V_{SYS}=5V$ ,  $V_{BATT}=3.7V$ ,  $F_{SW}=600kHz$

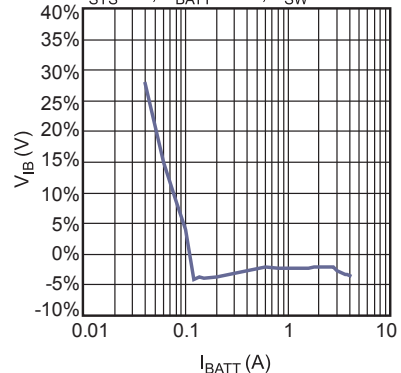

## TYPICAL PERFORMANCE CHARACTERISTICS

$V_{IN} = 5V$ ,  $C_{IN} = C_{BATT} = C_{SYS} = C_2 = 22\mu F$ ,  $L_1 = 1.5\mu H$ ,  $RS1 = 20m\Omega$ ,  $C_4 = C_{TMR} = 0.1\mu F$ , Battery Simulator, Unless Otherwise Noted.

**Battery Charge Curve**

$V_{BATT\_FULL} = 4.2V$

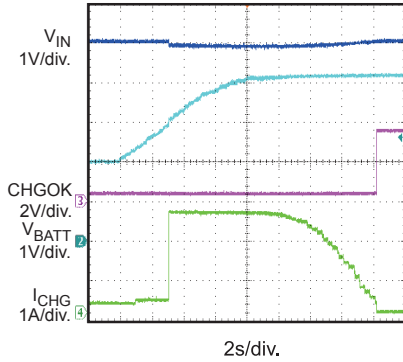

**Auto Recharge**

$V_{BATT\_FULL} = 4.2V$

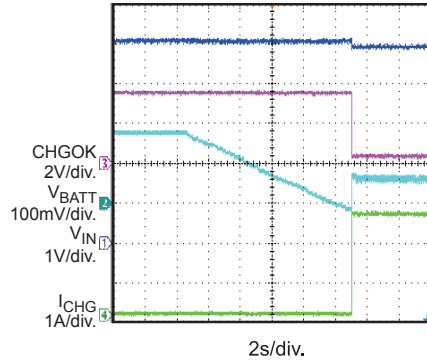

**Battery Float Steady State**

$V_{BATT\_FULL} = 4.2V$

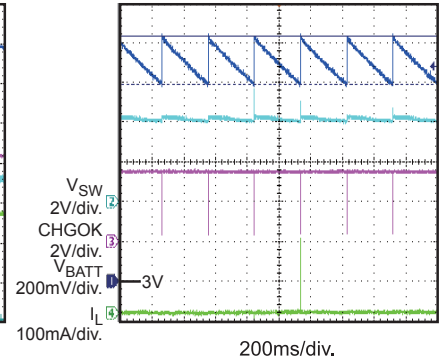

**TC Charge Steady State**

$V_{BATT\_FULL} = 4.2V$ ,  $V_{BATT} = 2V$ ,  
 $F_{SW} = 600kHz$

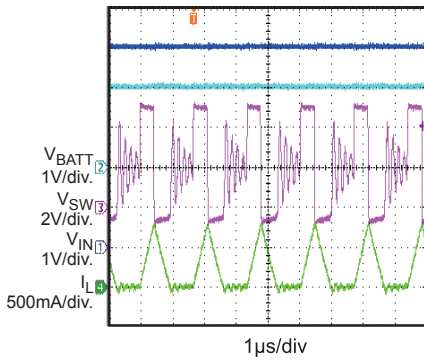

**CC Charge Steady State**

$V_{BATT\_FULL} = 4.2V$ ,  $V_{BATT} = 3.7V$ ,  
 $F_{SW} = 600kHz$

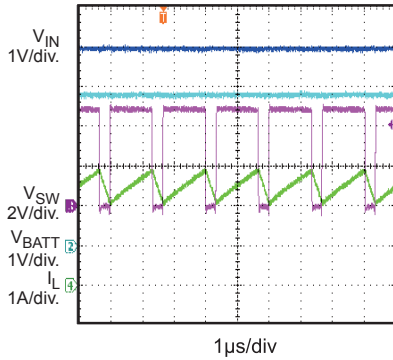

**CV Charge Steady State**

$V_{BATT\_FULL} = 4.2V$ ,  $V_{BATT} = 4.2V$ ,  
 $F_{SW} = 600kHz$

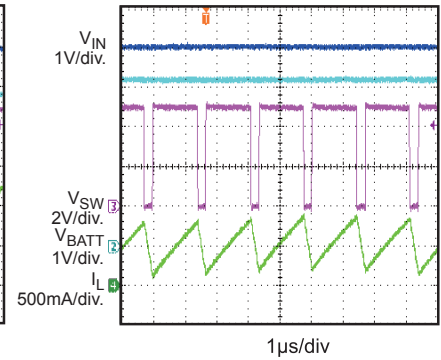

**Constant Current Charge Efficiency**

$V_{BATT\_FULL} = 4.2V$ ,  $V_{BATT} = 2.5-4.2V$ ,  
 $F_{SW} = 600kHz$ ,  $I_{CHG} = 2.5A$

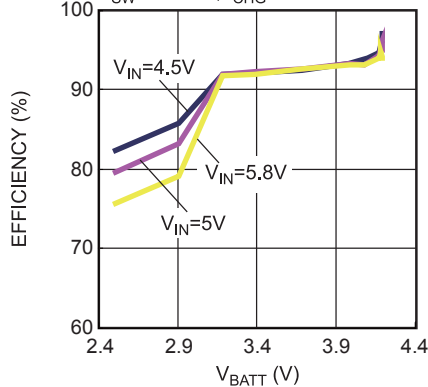

**Constant Voltage Charge Efficiency**

$V_{BATT\_FULL} = 4.2V$ ,  $V_{BATT} = 4.2V$ ,  
 $F_{SW} = 600kHz$ ,  $I_{CHG} = 2.5A$

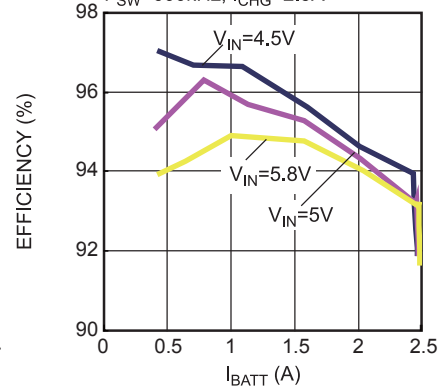

**CC Charge Current vs. Temperature**

$R_{ISET} = 47.5k\Omega$

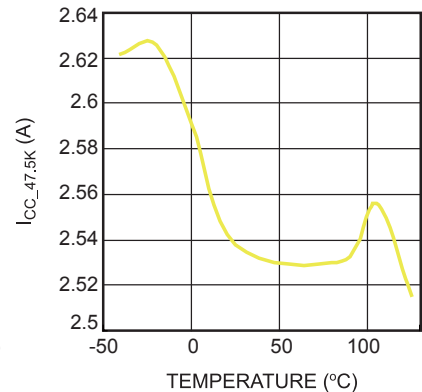

## TYPICAL PERFORMANCE CHARACTERISTICS *(continued)*

$V_{IN} = 5V$ ,  $C_{IN} = C_{BATT} = C_{SYS} = C_2 = 22\mu F$ ,  $L_1 = 1.5\mu H$ ,  $RS1 = 20m\Omega$ ,  $C_4 = C_{TMR} = 0.1\mu F$ , Battery Simulator, Unless Otherwise Noted.

### Power On, Charge Mode

$V_{BATT\_FULL}=4.2V$ ,  $V_{BATT}=3.7V$ ,  
 $I_{CHG}=2.5A$

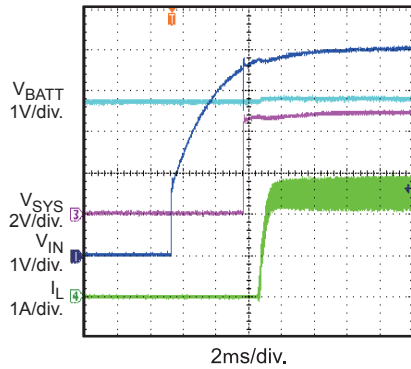

### Power Off, Charge Mode

$V_{BATT\_FULL}=4.2V$ ,  $V_{BATT}=3.7V$ ,  
 $I_{CHG}=2.5A$

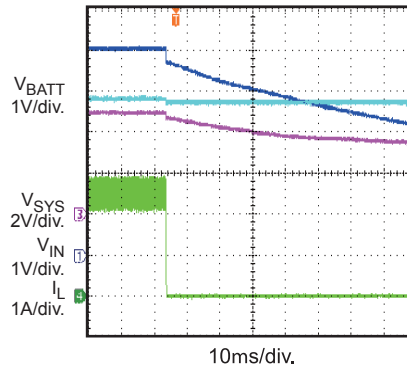

### EN On, Charge Mode

$V_{BATT\_FULL}=4.2V$ ,  $V_{BATT}=3.7V$ ,  
 $I_{CHG}=2.5A$

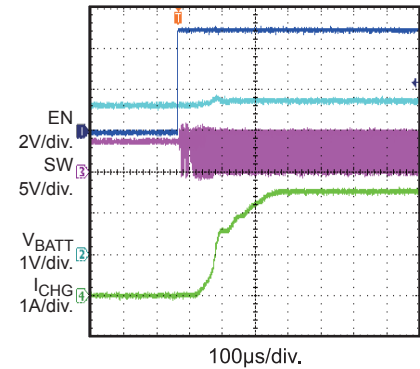

### En Off, Charge Mode

$V_{BATT\_FULL}=4.2V$ ,  $V_{BATT}=3.7V$ ,  
 $I_{CHG}=2.5A$

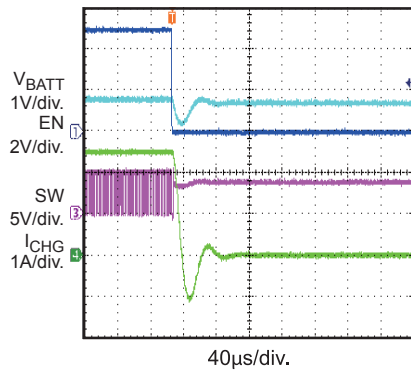

### Input Current Limit

$V_{BATT\_FULL}=4.2V$ ,  $V_{BATT}=3.7V$

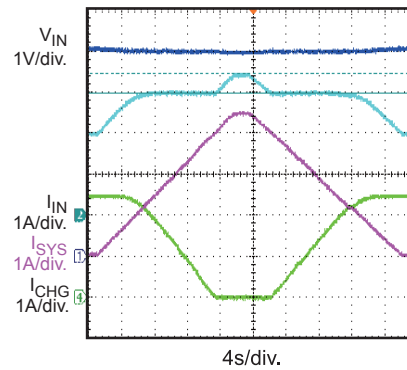

### Input Voltage Clamp

$V_{BATT\_FULL}=4.2V$ ,  $V_{BATT}=3.7V$

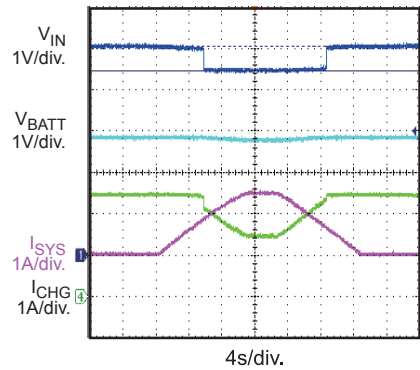

### Input Over Voltage Protection

$V_{IN}=5V$  to  $6.5V$ ,  $V_{BATT}=3.7V$ ,  
Enabled Charger

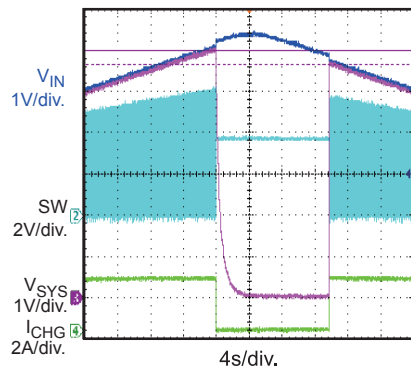

**TYPICAL PERFORMANCE CHARACTERISTICS (continued)**

$V_{IN} = 0V$ ,  $V_{BATT}=3.7V$ ,  $C_{IN} = C_{BATT} = C_{SYS} = C_2 = 22\mu F$ ,  $L_1 = 1.5\mu H$ ,  $RS1 = 20m\Omega$ ,  $C_4 = C_{TMR} = 0.1\mu F$ , Battery Simulator, Unless Otherwise Noted.

**Power On, Boost Mode**

$V_{SYS\_SET}=5V$ ,  $V_{BATT}=3.7V$ ,  
No SYS Load

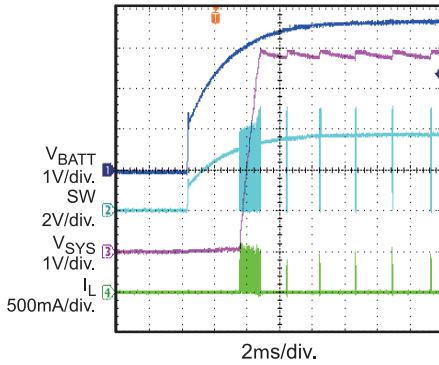

**Power Off, Boost Mode**

$V_{SYS\_SET}=5V$ ,  $V_{BATT}=3.7V$ ,  
No SYS Load

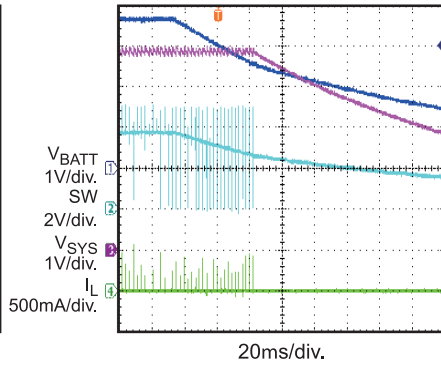

**Power On, Boost Mode**

$V_{SYS\_SET}=5V$ ,  $V_{BATT}=3.7V$ ,  
 $R_{SYS\_LOAD}=5\Omega$

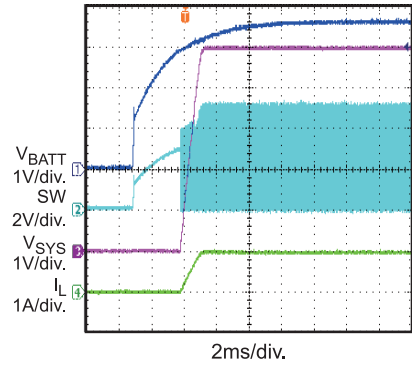

**Power Off, Boost Mode**

$V_{SYS\_SET}=5V$ ,  $V_{BATT}=3.7V$ ,  
 $R_{SYS\_LOAD}=5\Omega$

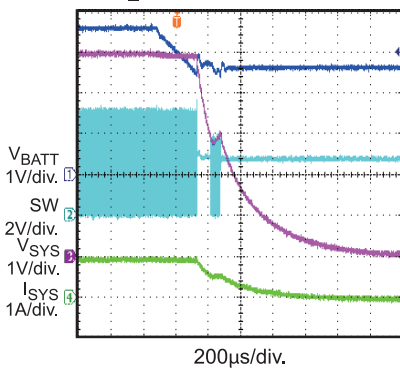

**Mode On, Boost Mode**

$V_{SYS\_SET}=5V$ ,  $V_{BATT}=3.7V$ ,  
No SYS Load

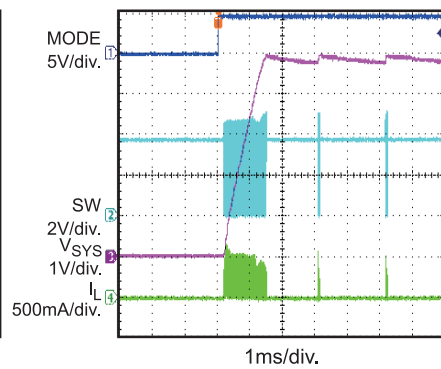

**Mode Off, Boost Mode**

$V_{SYS\_SET}=5V$ ,  $V_{BATT}=3.7V$ ,  
No SYS Load

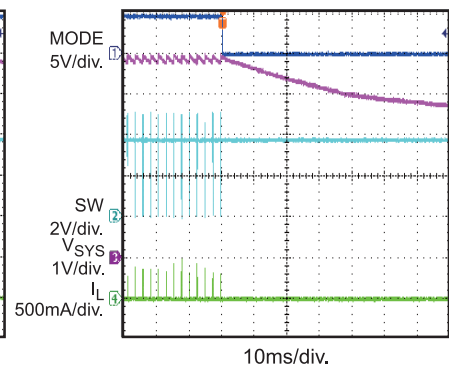

**Mode On, Boost Mode**

$V_{SYS\_SET}=5V$ ,  $V_{BATT}=3.7V$ ,  
 $R_{SYS\_LOAD}=5\Omega$

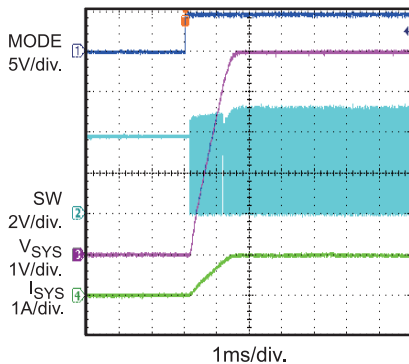

**Mode Off, Boost Mode**

$V_{SYS\_SET}=5V$ ,  $V_{BATT}=3.7V$ ,  
 $R_{SYS\_LOAD}=5\Omega$

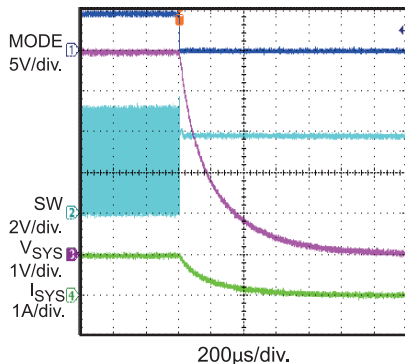

**SYS Output Current Limit**

$V_{SYS\_SET}=5V$ ,  $V_{BATT}=3.7V$ ,  
 $I_{OLIM\_SET}=1A$

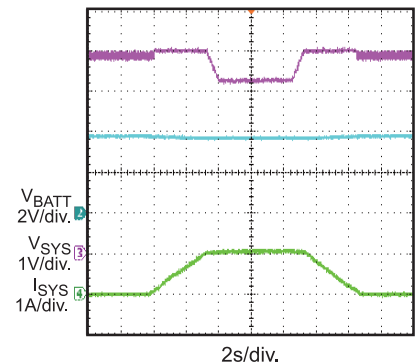

**TYPICAL PERFORMANCE CHARACTERISTICS (continued)**

$V_{IN} = 0V$ ,  $V_{BATT}=3.7V$ ,  $C_{IN} = C_{BATT} = C_{SYS} = C2 = 22\mu F$ ,  $L1 = 1.5\mu H$ ,  $RS1 = 20m\Omega$ ,  $C4 = C_{TMR} = 0.1\mu F$ , Battery Simulator, Unless Otherwise Noted.

**SYS Short Circuit Entry**

$V_{SYS\_SET}=5V$ ,  $V_{BATT}=3.7V$ ,  $I_{SYS}= 2.6A$

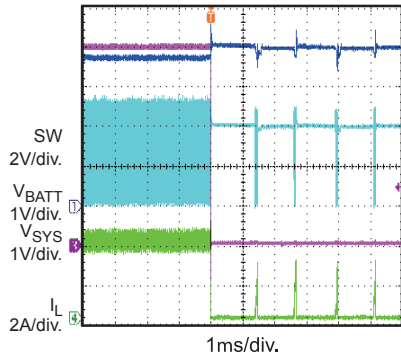

**SYS Short Circuit Entry**

$V_{SYS\_SET}=5V$ ,  $V_{BATT}=3.7V$ ,  $I_{SYS}= 2.6A$

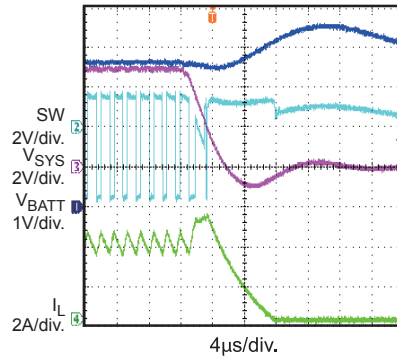

**SYS Short Circuit Recovery**

$V_{SYS\_SET}=5V$ ,  $V_{BATT}=3.7V$ ,  $I_{SYS}= 2.6A$

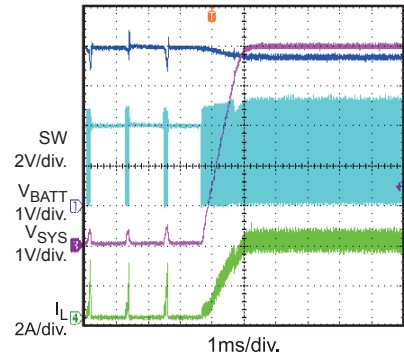

**SYS Over Voltage Protection**

$V_{SYS\_SET}=6.5V$ ,  $V_{BATT}=3.7V$

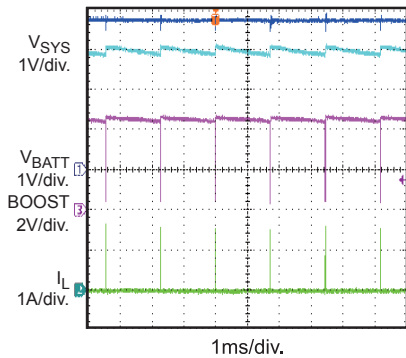

**SYS Load Transient**

$V_{SYS\_SET}=5V$ ,  $V_{BATT}=3V$ ,  $I_{SYS}= 0A$  to  $2.2A$

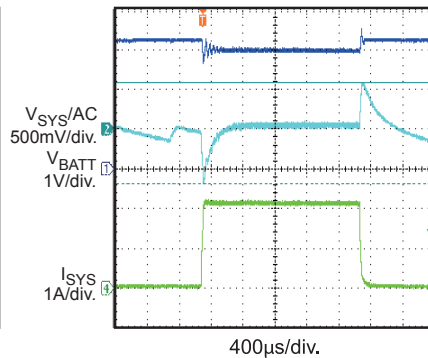

**SYS Load Transient**

$V_{SYS\_SET}=5V$ ,  $V_{BATT}=3.7V$ ,  $I_{SYS}= 0A$  to  $2.2A$

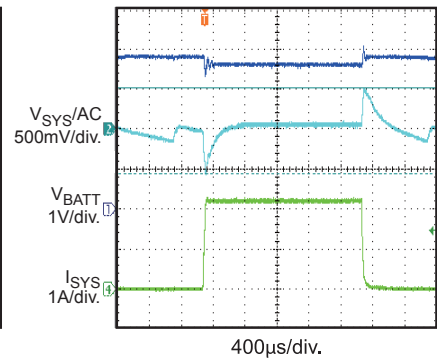

**SYS Load Transient**

$V_{SYS\_SET}=5V$ ,  $V_{BATT}=3.7V$ ,  $I_{SYS}= 0.3A$  to  $2.2A$

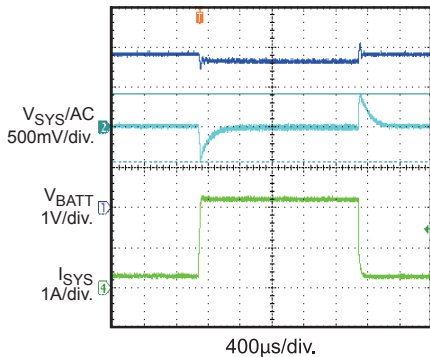

**Boost Efficiency**

$V_{SYS\_SET}=5V$ ,  $F_S=600kHz$

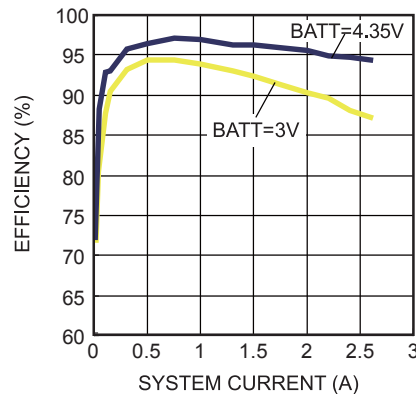

**Boost Output V-I Curve**

$V_{BATT}=3.7V$ ,  $V_{SYS}=5V$ ,  $R_{OLIM}=53.6k\Omega$

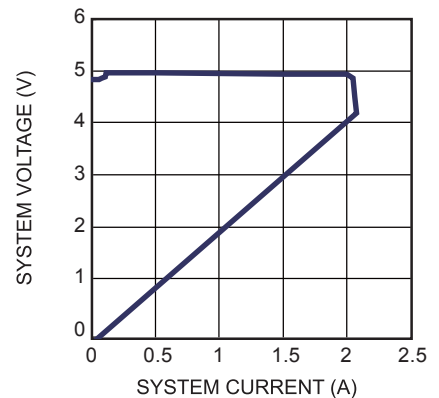



**TYPICAL PERFORMANCE CHARACTERISTICS (continued)**

$V_{IN} = 5V$  (typ.),  $V_{BATT}=3.7V$  (typ.),  $C_{IN} = C_{BATT} = C_{SYS} = C2 = 22\mu F$ ,  $L1 = 1.5\mu H$ ,  $RS1 = 20m\Omega$ ,  $C4 = C_{TMR} = 0.1\mu F$ , Battery Simulator, Unless Otherwise Noted.

**Sleep\_Mode\_Battery Current vs. Temperature**

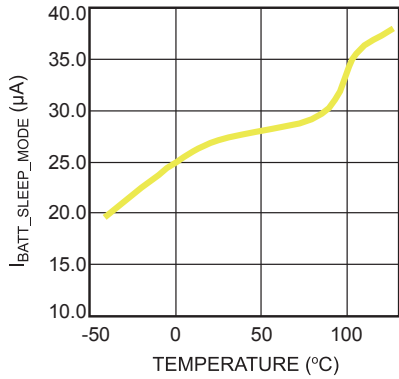

**SYS\_OVP vs. Temperature**

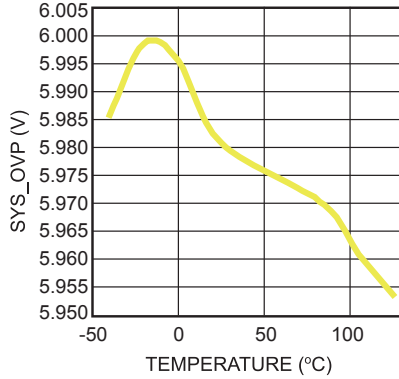

**Output\_Current\_Limit\_2.2A vs. Temperature**

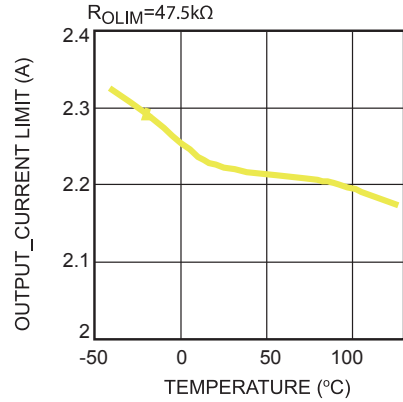

**BATT\_Full VBH vs. Temperature**

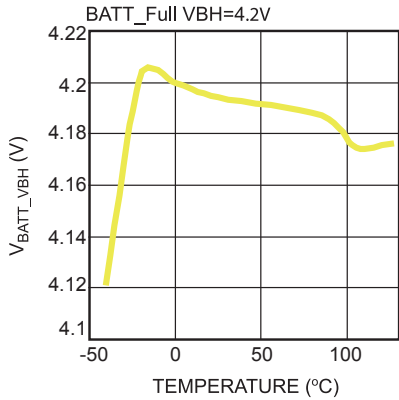

**BATT\_Full VBL vs. Temperature**

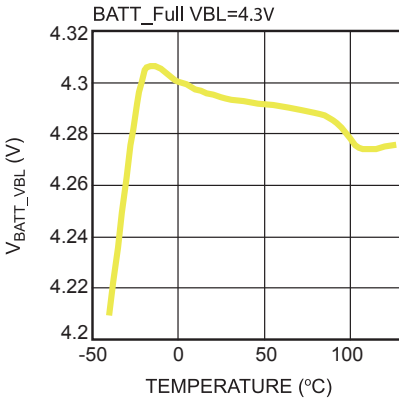

**BATT\_Full VB Float vs. Temperature**

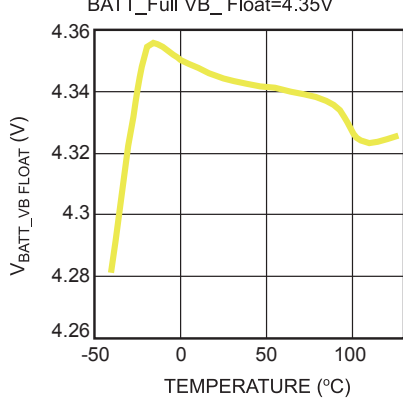

**BATT\_OVP\_VBH\_% vs. Temperature**

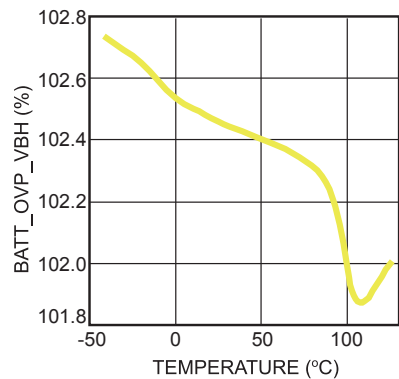

**BATT\_OVP\_VBL\_% vs. Temperature**

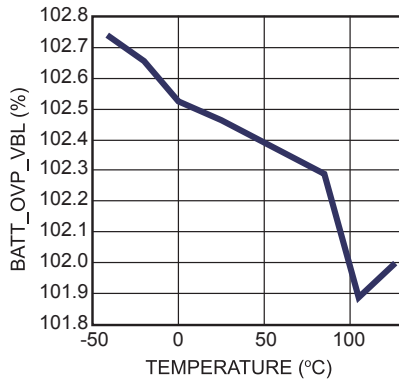

**BATT\_OVP\_VB Float\_% vs. Temperature**

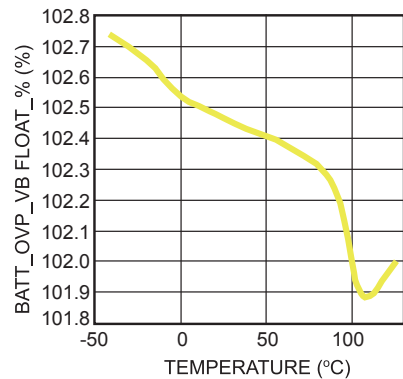

**TYPICAL PERFORMANCE CHARACTERISTICS** *(continued)*

$V_{IN} = 5V$  (typ.),  $V_{BATT}=3.7V$  (typ.),  $C_{IN} = C_{BATT} = C_{SYS} = C2 = 22\mu F$ ,  $L1 = 1.5\mu H$ ,  $RS1 = 20m\Omega$ ,  $C4 = C_{TMR} = 0.1\mu F$ , Battery Simulator, Unless Otherwise Noted.

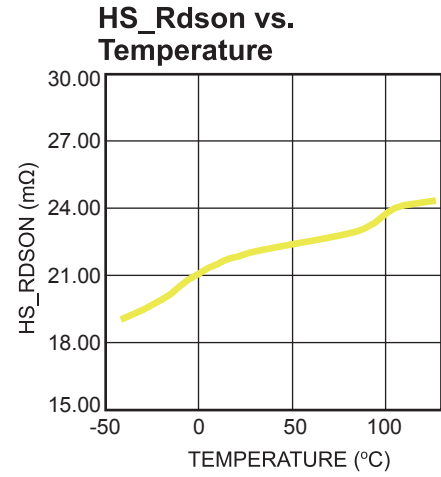
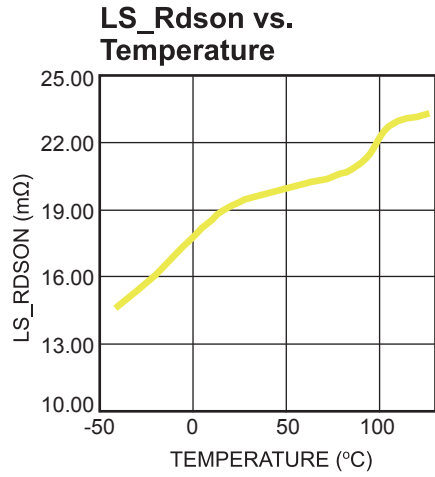
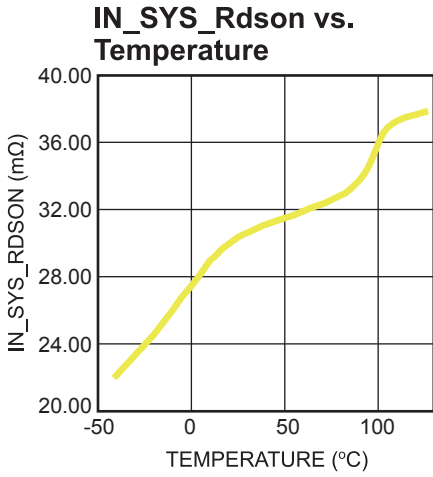

**FUNCTIONAL BLOCK DIAGRAM (Charge Mode)**

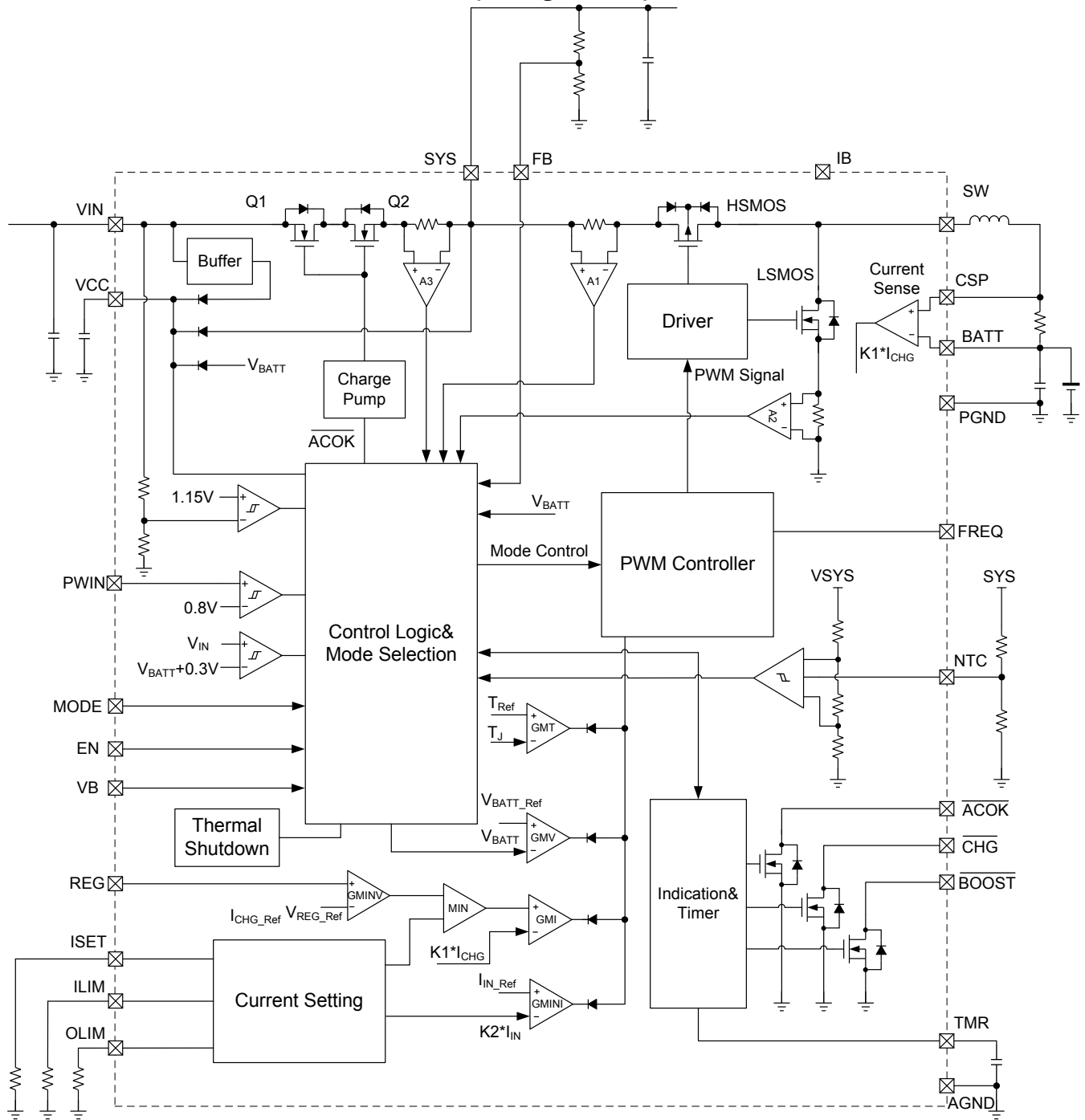

**Figure 1 : Functional Block Diagram in Charger Mode**

**FUNCTIONAL BLOCK DIAGRAM (Boost Mode)**

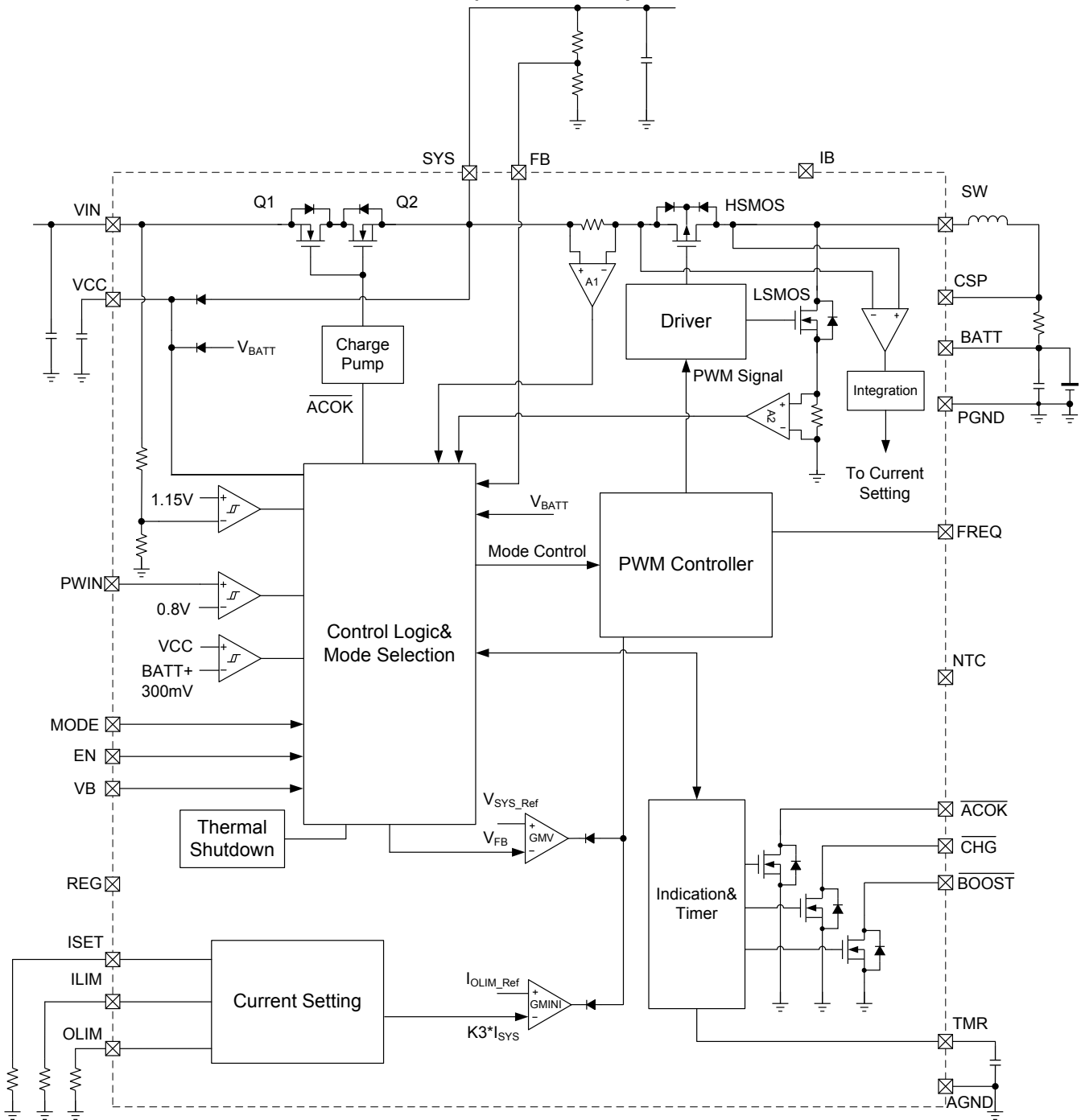

**Figure 2 : Functional Block Diagram in Boost Mode**

**OPERATION FLOW CHART**

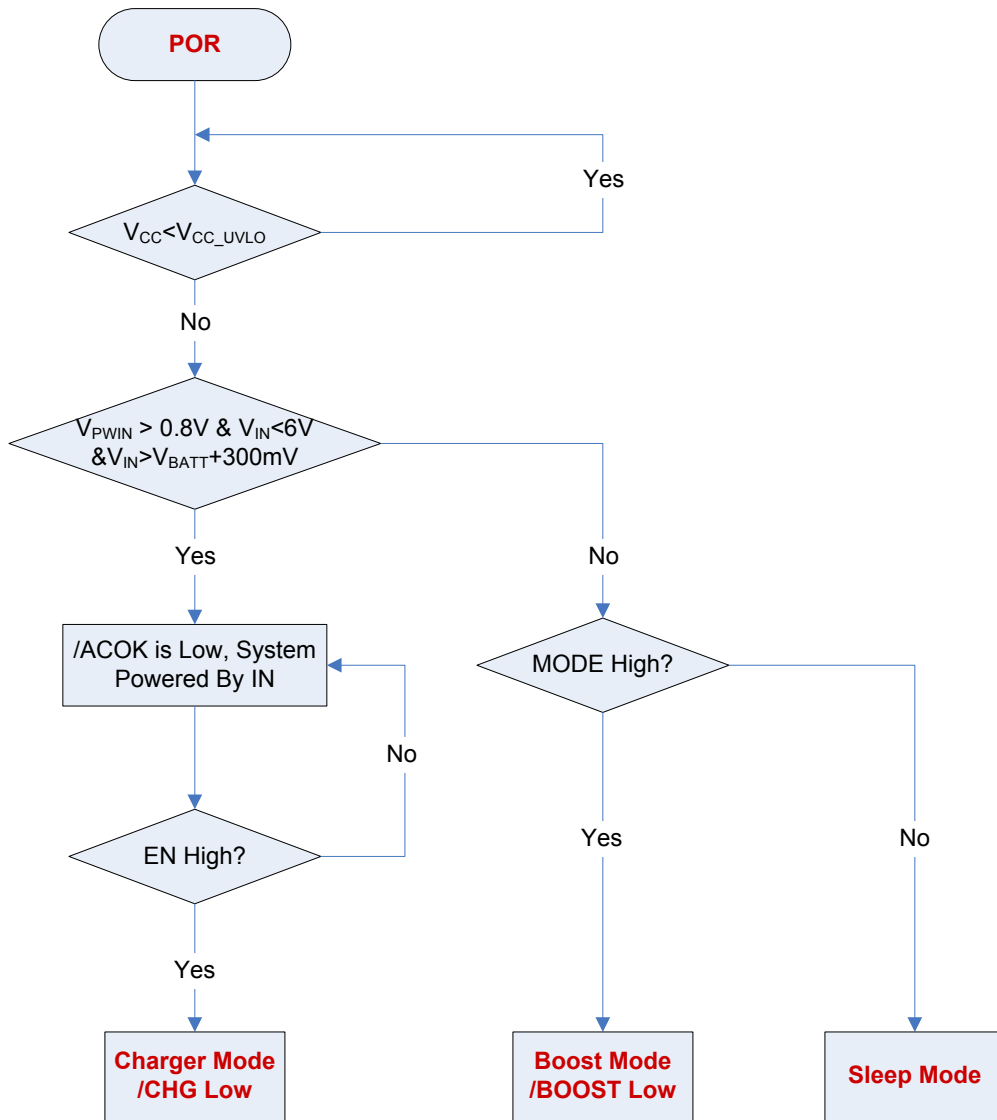

**Figure 3: Mode Selection Flow Chart**

**OPERATION FLOW CHART (Continued)**

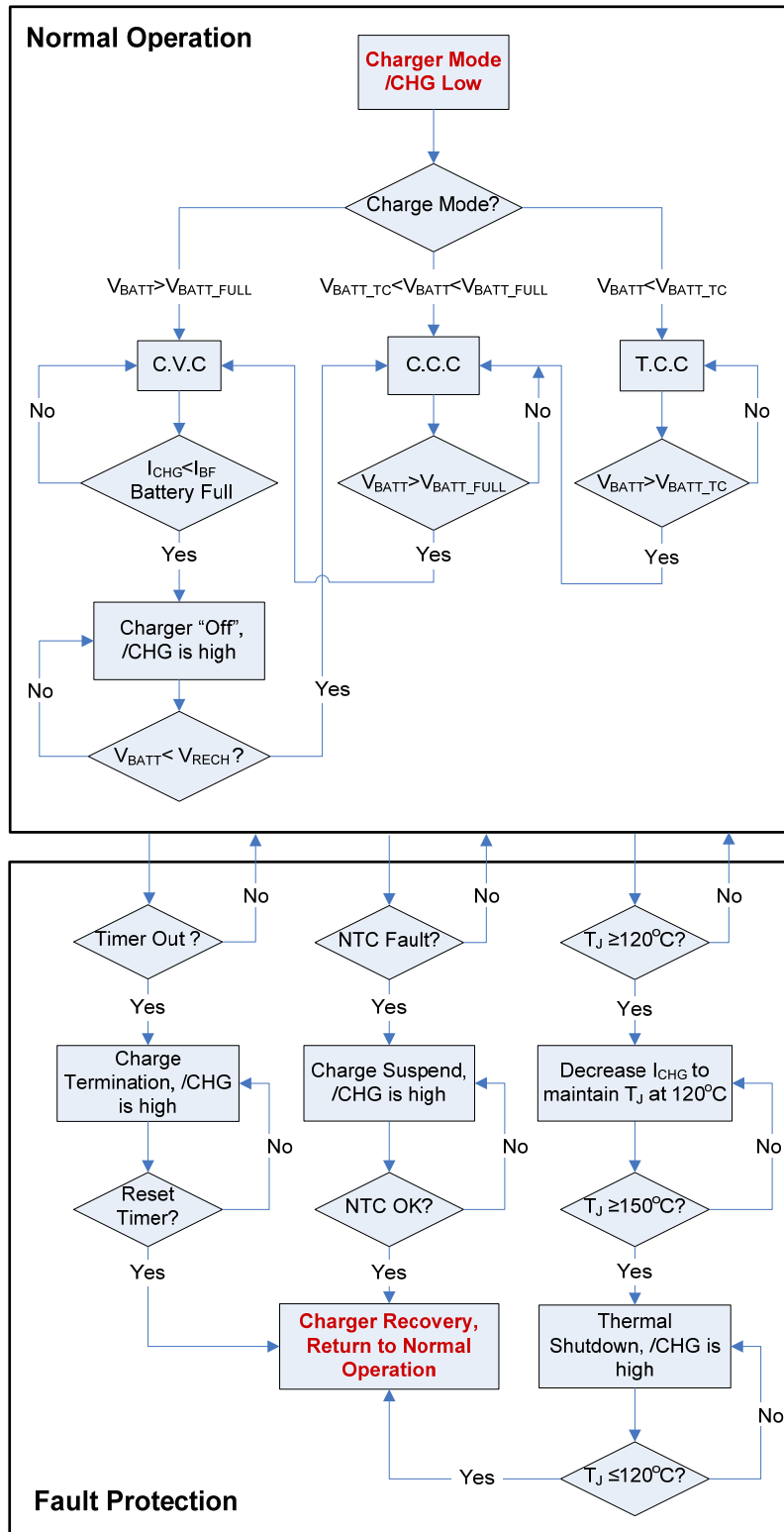

**Figure 4: Operation Flow Chart in Charger Mode**

OPERATION FLOW CHART (Continued)

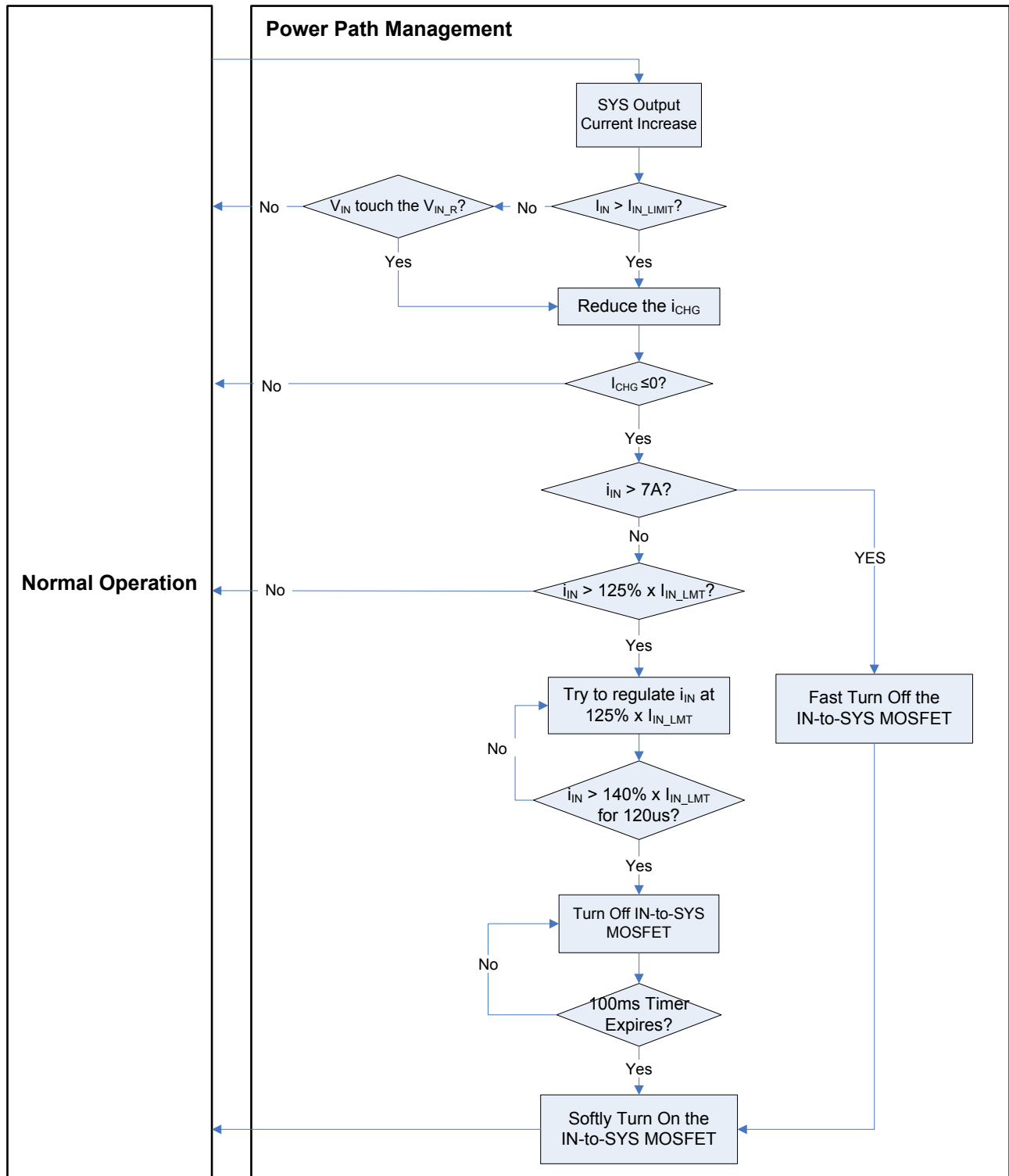
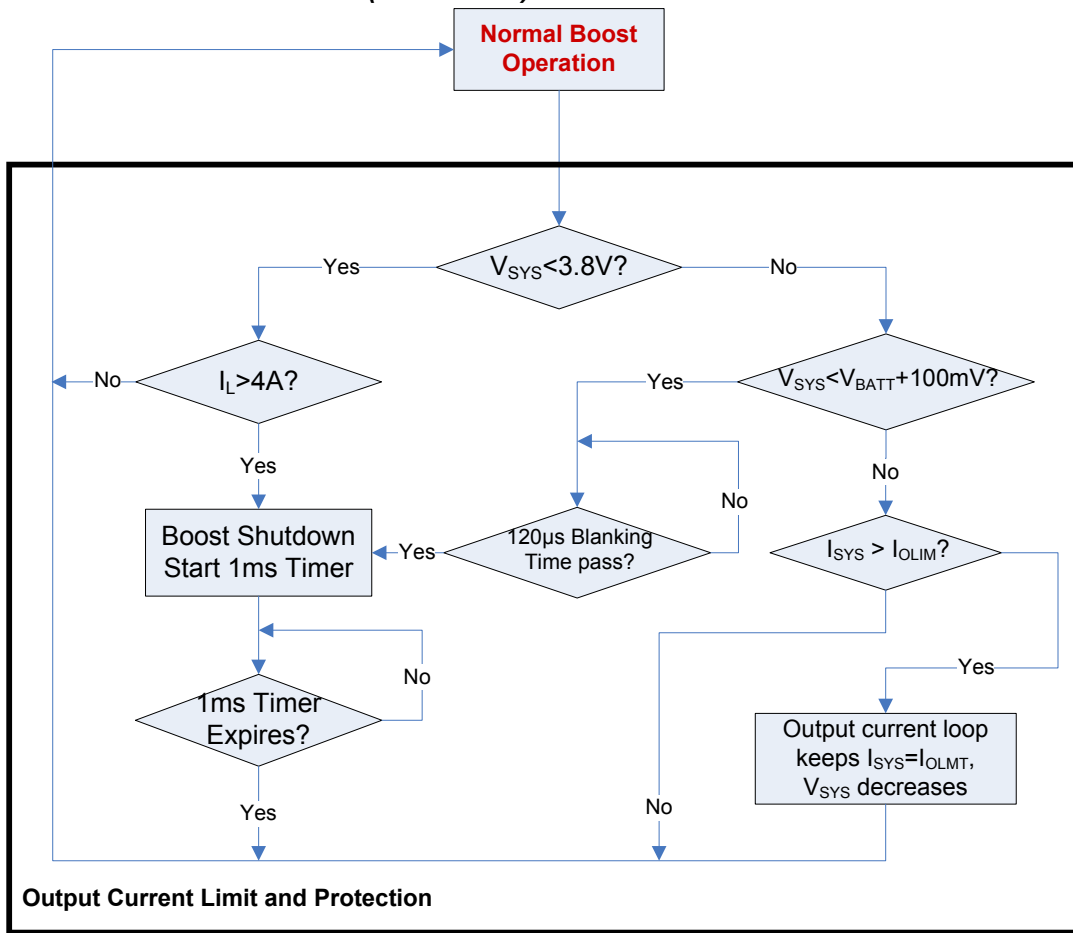

Figure 5: Power-path Management in Charge Mode

**OPERATION FLOW CHART (Continued)**

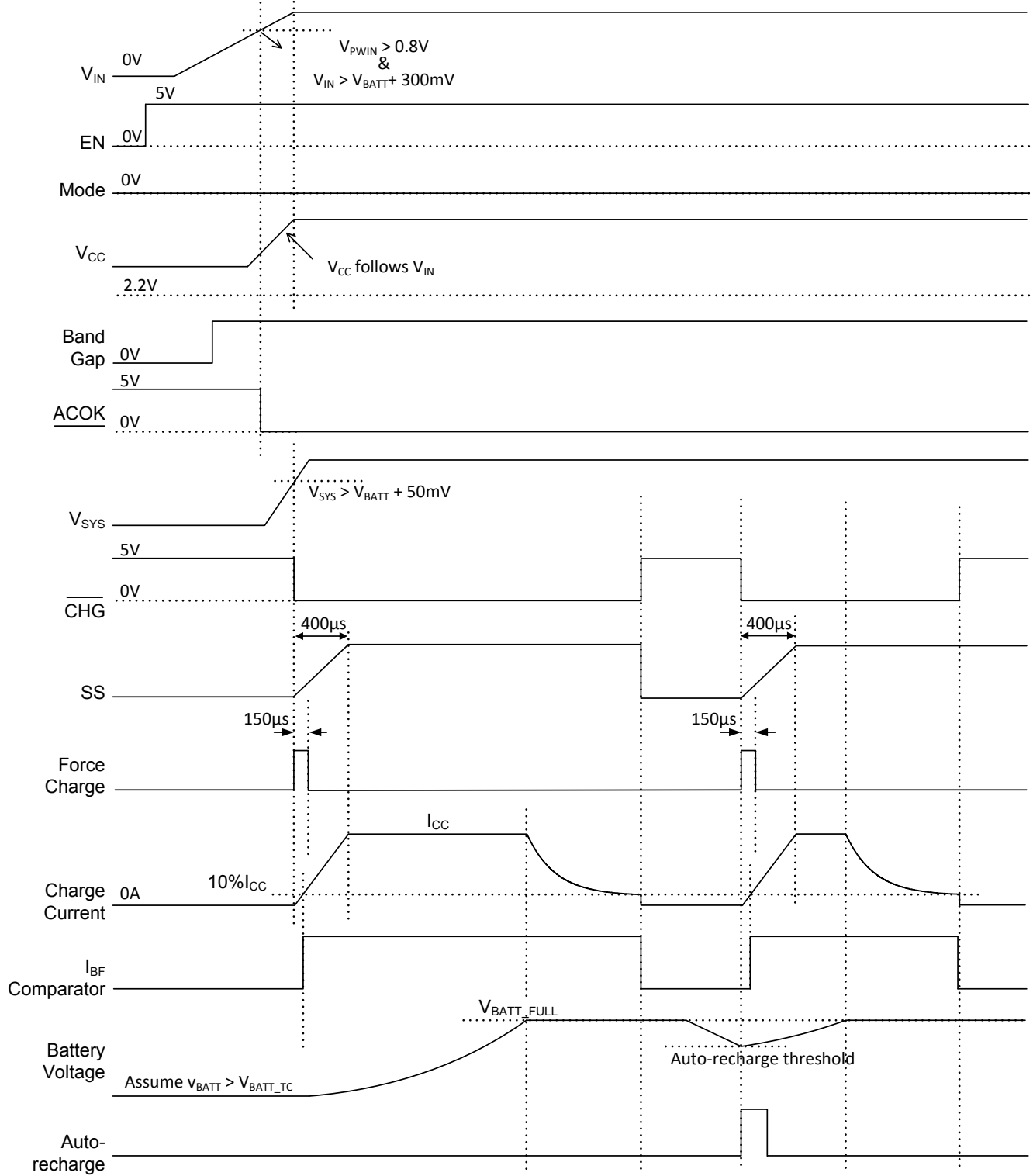

**Figure 6: Operation Flow Chart in Boost Mode**



### START UP TIME FLOW IN CHARGE MODE

Condition: EN = 5V, Mode = 0V, /ACOK and /CHG are always pulled up to an external constant 5V



**Figure 7: Input Power Start-up Time Flow in Charge Mode**

### START UP TIME FLOW IN CHARGE MODE

Condition:  $V_{IN} = 5V$ , Mode = 0V, /ACOK and /CHG are always pulled up to an external constant 5V.

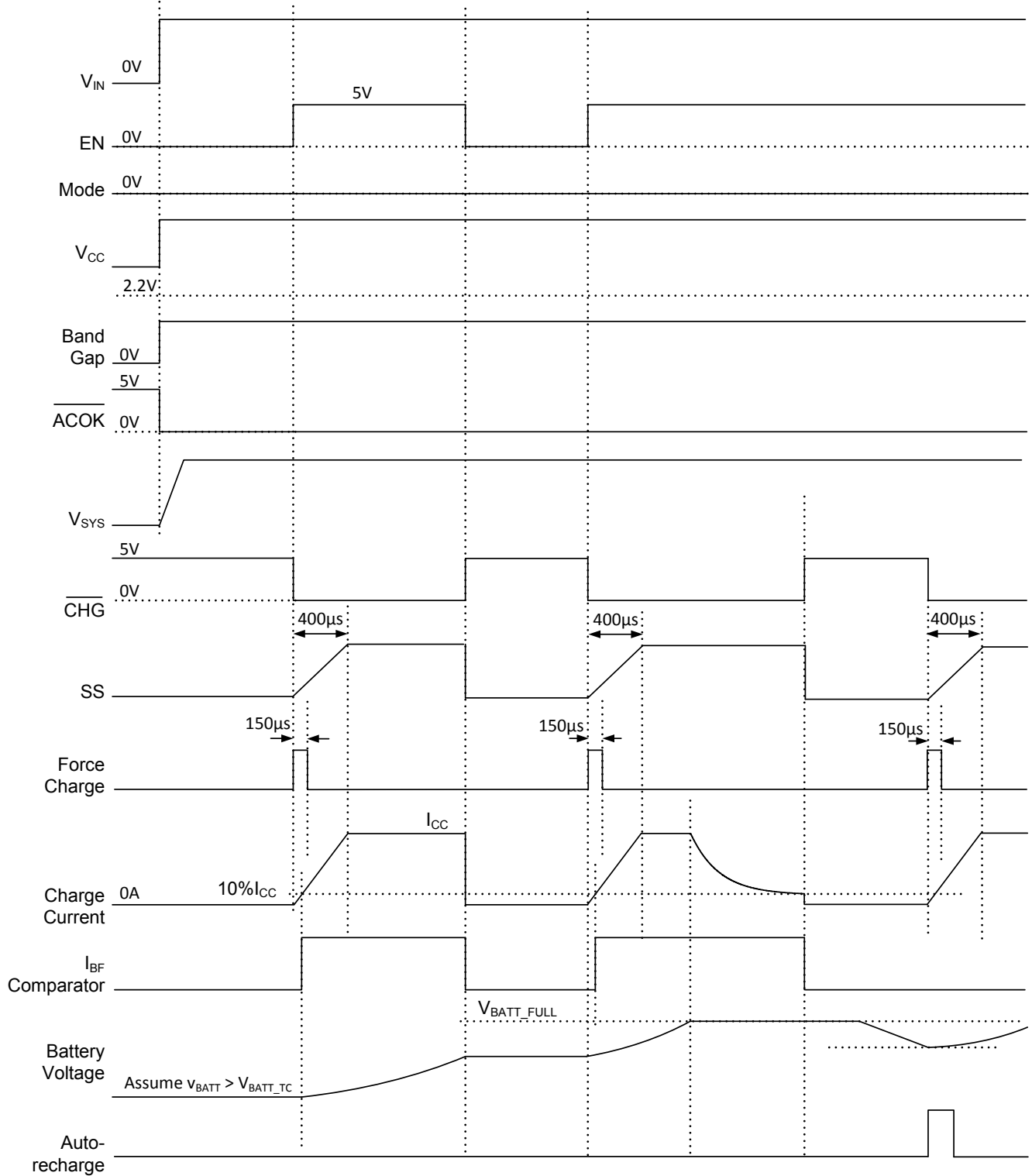
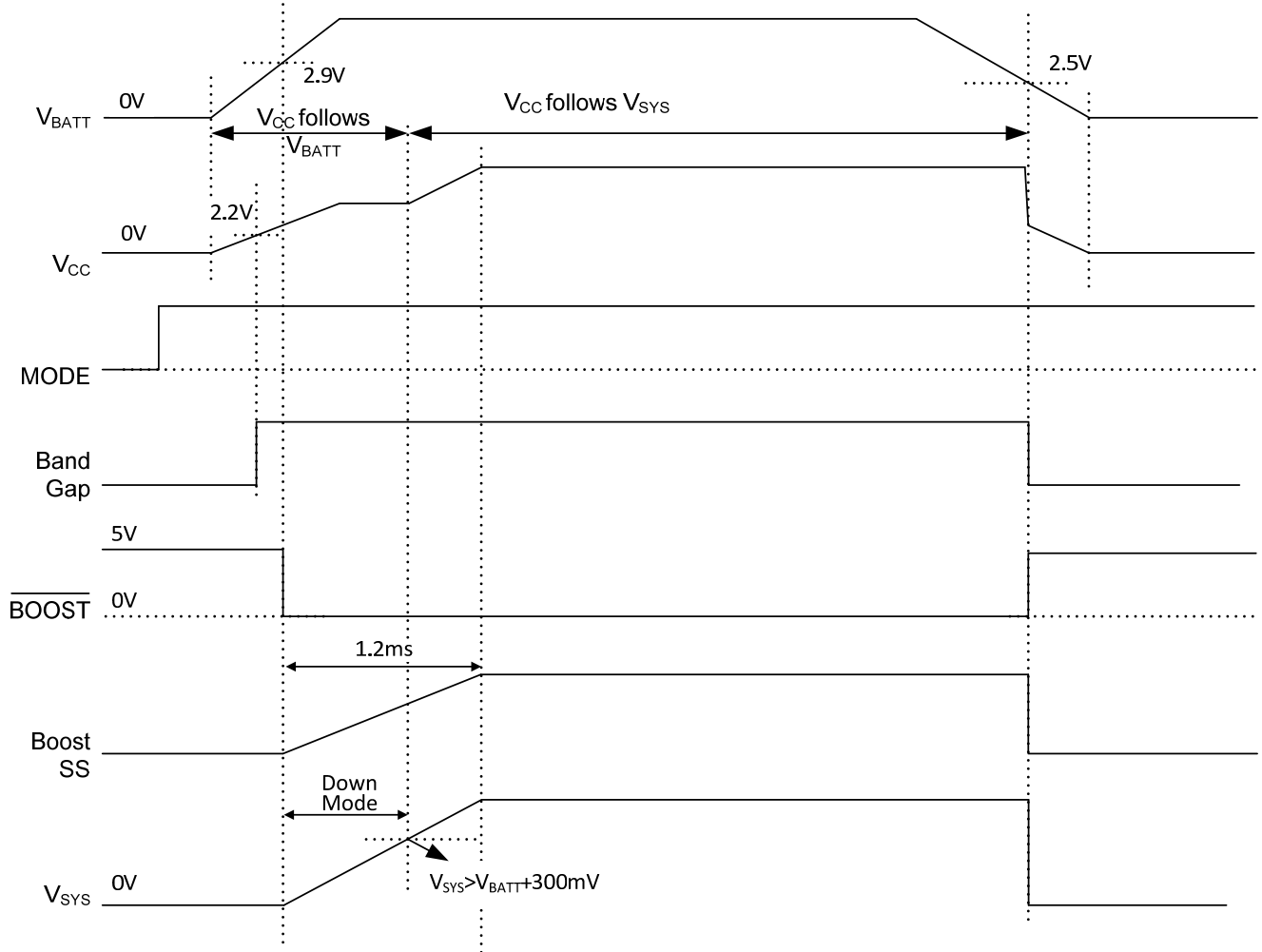

Figure 8: EN Start-up Time Flow in Charge Mode

### START UP TIME FLOW IN BOOST MODE

Condition:  $V_{IN} = 0V$ , Mode = 5V, /Boost is always pulled up to an external constant 5V.



**Figure 9: Battery Power Start-up Time Flow in Boost Mode**

### START UP TIME FLOW IN BOOST MODE

Condition:  $V_{IN} = 0V$ , /Boost is always pulled up to an external constant 5V.

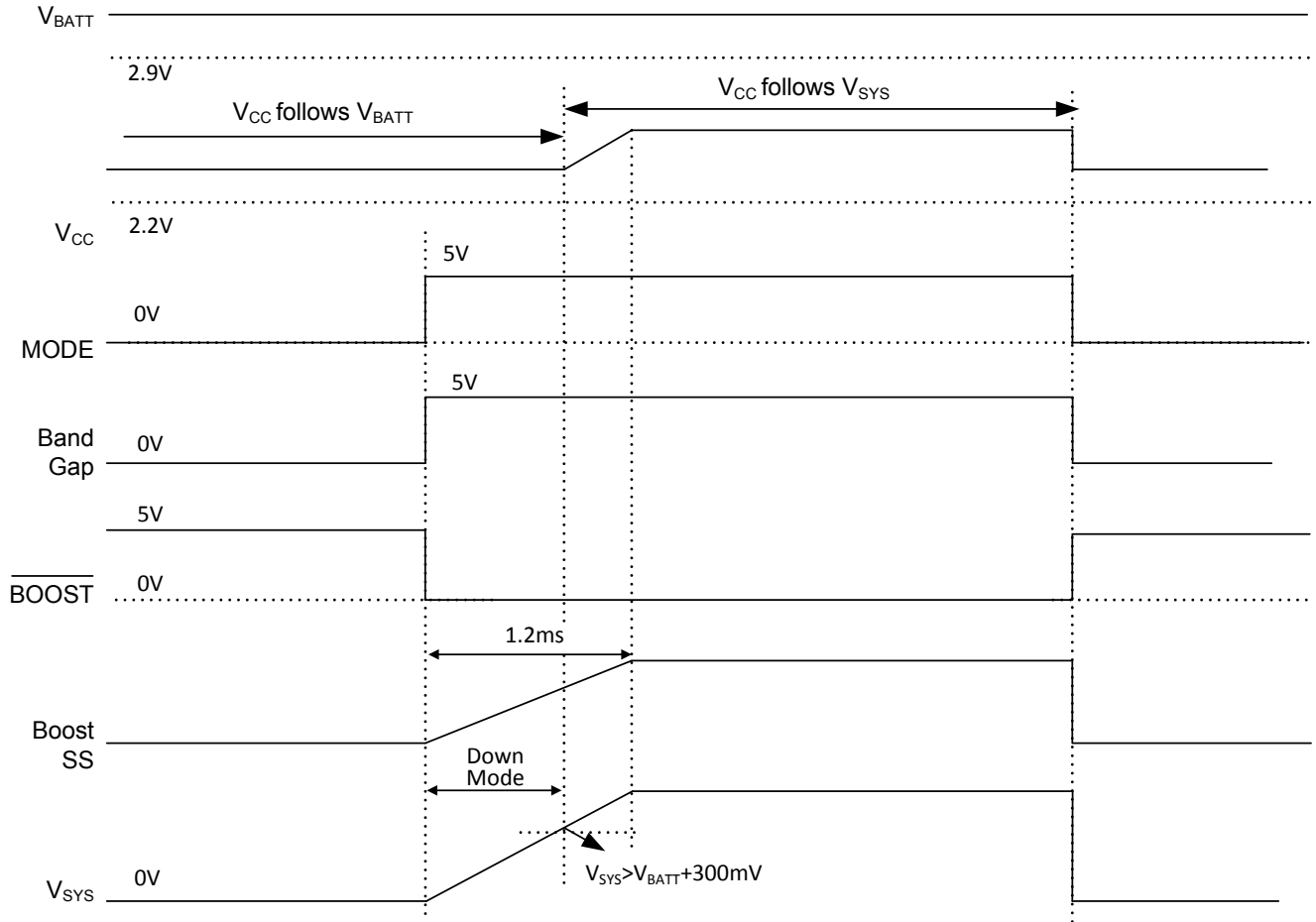

**Figure 10: Mode Start-up Time Flow in Boost Mode**

## OPERATION

### INTRODUCTION

The MP2636 is a highly-integrated, flexible, synchronous switch-mode battery charger with system power path management, designed for single-cell Li-ion or Li-polymer batteries used in a wide range of applications. Depending on the status of the Input supply, the MP2636 can operate in three modes: charge mode, boost mode and sleep mode.

In charge mode, the MP2636 can work with single cell Li-ion or Li-polymer battery. In boost mode, MP2636 boosts the battery voltage to  $V_{SYS\_SET}$  to power higher voltage system rails. In sleep mode both charging and boost operations are disabled and the device enters a sleep mode to help reduce the overall power consumption. The MP2636 monitors  $V_{IN}$  to allow smooth transition between different modes of operation.

### CHARGER MODE OPERATION

#### Charge Cycle

In charge mode, the MP2636 has five control loops to regulate input voltage, input current, charge current, charge voltage and device junction temperature. The MP2636 charges the battery in three phases, trickle current (TC), constant current (CC), and constant voltage (CV). While charge operation is enabled, all five loops are active but only one determines the IC behavior. A typical battery charge profile is depicted in Figure 11(a). The charger stays in TC charge mode until the battery voltage reaches a TC-to-CC threshold. Otherwise the charger enters CC charge mode. When the battery voltage rises to the CV-mode threshold, the charger operates in constant voltage mode. Figure 12(b) shows a typical charge profile when the input-current-limit loop dominates during the CC charge mode, and in this case the charger maximizes the charging current due to the switching-mode charging solution, resulting in faster charging than a traditional linear solution.

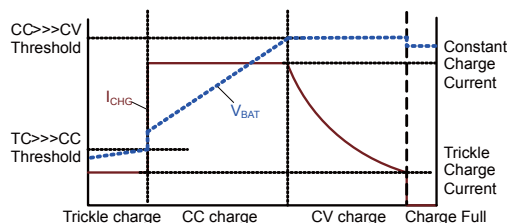

a) Without input current limit

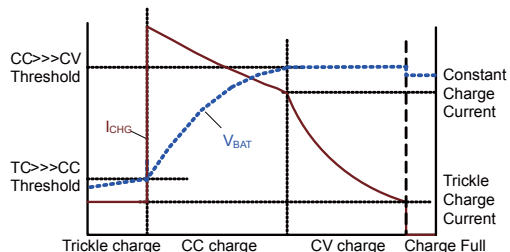

b) With input current limit

**Figure 11: Typical Battery Charge Profile**

#### Auto-recharge

Once the battery charge cycle completes, the charger remains off. During this time, the external load may consume battery power, or the battery may self discharge. To ensure the battery will not go into depletion, a new charge cycle automatically begins when the battery voltage falls below the auto-recharge threshold when the input power is present. The timer is reset when the auto-recharge cycle begins.

During the off state after the battery is fully charged, if the input power re-starts or the EN signal refreshes, the charge cycle will start and the timer will re-set no matter what the battery voltage is.

#### Battery Over-Voltage Protection

The MP2636 has battery over-voltage protection. If the battery voltage exceeds the battery over-voltage threshold, (102.5% of the battery full voltage), charging is disabled. Under this condition, an internal 5kΩ dummy load draws a current from the BATT pin to decrease the battery voltage and protect the battery.

### Timer Operation

The MP2636 uses an internal timer to terminate the charging. The timer remains active during the charging process. An external capacitor between TMR and GND programs the charge cycle duration.

If charging remains in TC mode beyond the trickle-charge time,  $\tau_{TC\_TMR}$ , the charging will terminate. The following equation determines the length of the trickle-charge period:

$$\tau_{TC\_TMR} = \frac{4.5 \times 10^4 \times 1.6(V) \times C_{TMR}(\mu F)}{1.25 \times I_{TC}(A) \times RS1(m\Omega) + 2(\mu A)} \text{ (s)} \quad (1)$$

The maximum total charge time is:

$$\tau_{TOTAL\_TMR} = \frac{3.4 \times 10^6 \times 1.6(V) \times C_{TMR}(\mu F)}{1.25 \times I_{CHG}(A) \times RS1(m\Omega) + 2(\mu A)} \text{ (s)} \quad (2)$$

### Negative Thermal Coefficient (NTC) Input

The MP2636 has a built-in NTC resistance window comparator, which allows MP2636 to monitor the battery temperature via the battery-integrated thermistor. Connect an appropriate resistor from  $V_{SYS}$  to the NTC pin and connect the thermistor from the NTC pin to GND. The resistor divider determines the NTC voltage depending on the battery temperature. If the NTC voltage falls outside of the NTC window, the MP2636 stops charging. The charger will then restart if the temperature goes back into NTC window range. During the NTC fault, the charge timer is suspended.

### Input Voltage Range for Different Operating Mode

MP2636 operates in different mode based on the state of the input. (see Table 1)

**Charge Mode:** A resistor divider connected to the input and centered at PWIN pin determines the input voltage UVLO point in charge mode of the MP2636.

$$V_{PWIN} = V_{IN} \times \frac{RL}{RH + RL} \text{ (V)} \quad (3)$$

If the voltage at PWIN pin is higher than 0.8V, and the input voltage is lower than 6.0V, the MP2636 works in the charge mode. During normal operation ( $V_{UVLO} < V_{IN} < 6.0V$ ), the MP2636 can be forced into Boost Mode by pulling PWIN pin to GND.

To achieve wide operation suggest set the

minimum input voltage at 4.5V.

**Boost Mode:** Boost mode can be enabled via the MODE pin as long as the input voltage is higher than 6V or the voltage at PWIN is lower than 0.8V.

**Sleep Mode:** when the input voltage is lower than 2V, the MP2636 enters sleep mode operation thus consuming very low current from the battery.

### Input Current Limiting in Charge Mode

The MP2636 has a dedicated pin that programs the input-current limit. The average input current of the MP2636 is determined by the resistor value between ILIM and GND. As the total input current approaches the programmed input current limit, charge current is reduced to allow priority to system power.

Use the following equation to determine the input current limit threshold,

$$I_{ILIM}(A) = \frac{43.3(k\Omega)}{R_{ILIM}(k\Omega)} - 0.05 \quad (4)$$

### Input Voltage Regulation in Charge Mode

In charge mode, if the input power source is not sufficient to support the charge current and system load current, the input voltage will decrease. As the input voltage approaches the programmed input voltage regulation value, the charge current is reduced to allow priority of the system power and maintain proper regulation of the input voltage.

The input voltage can be regulated by resistor divider from IN pin to REG pin to AGND according to the following equation:

$$V_{REG} = V_{IN\_R} \times \frac{R4}{R3 + R4} \text{ (V)} \quad (5)$$

where  $V_{REG}$  is the internal voltage reference, which is 1.2V, and the  $V_{IN\_R}$  is the desired regulation voltage.

### Integrated Over Current Protection and Over Voltage Protection for Pass-through Path

The MP2636 has an integrated IN-to-SYS pass-through path to allow direct connection of the input voltage to the system even if the charging is disabled. Based on the above, the MP2636 continuously monitors the input current and voltage. In the event of an input OC limit or input UV limit, the charge current will be reduced to ensure the priority of the system requirement.

In addition, the MP2636 also features input over current and voltage protection for the IN to SYS pass-through path.

#### Input over-current protection (OCP):

The MP2636 implements input over-current protection in 3 different ways:

- When the total input current exceeds input over-current threshold  $I_{IN\_OCP}$ , which is 125% of the input current limit threshold  $I_{IN\_LMT}$  set by  $R_{LIM}$ , Q2 is controlled linearly to regulate the input current.
- When the current reaches input over-current shutdown threshold  $I_{INOC\_SHDN}$  (140% of the  $I_{IN\_LMT}$ ) after a 120µs blanking time, Q2 will be turned off, and then restarting after 100ms recovery time.
- When the input current exceeds fast off threshold (preset at 7A), both Q1 and Q2 are turned off immediately, and then restarting after 100ms recovery time.

#### Input over-voltage protection (OVP):

The MP2636 has a preset 6V input over voltage threshold, once the input voltage exceeds the OVP threshold, the IN-to-SYS pass-through path will be bridged off to prevent the over voltage event happening at SYS side when plugging in a wrong adapter.

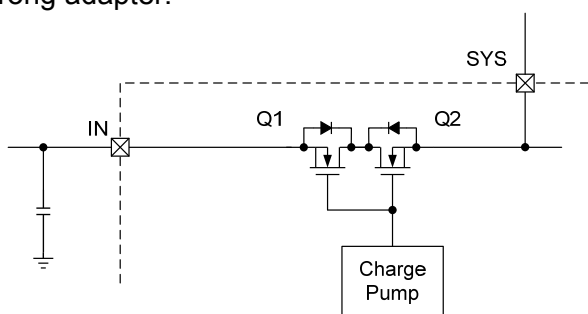

**Figure 12: IN-to-SYS Pass-through Path**

### Charge Current Setting

The external sense resistors,  $RS1$ , and  $R_{ISET}$ , program the battery charge current  $I_{CHG}$ . Select  $R_{ISET}$  based on  $RS1$ :

$$I_{CHG}(A) = \frac{2400}{R_{ISET}(k\Omega) \times RS1(m\Omega)} \quad (6)$$

### Battery Current Analog Output

The MP2636 has an IB pin to report the real-time battery current in both charge and boost mode. The voltage at IB is a fraction of the battery current given  $RS1$  is 20mΩ.

$$\text{Boost Mode: } V_{IB}(V) = I_{BATT}(A) \times 0.4(R) \quad (7)$$

$$\text{Charge Mode: } V_{IB}(V) = I_{CHG}(A) \times 0.36(R) \quad (8)$$

### Battery Short Protection

When battery voltage is lower than the TC-to-CC threshold, Q3 peak current limit will be reduced by half (please refer to the block diagram). Furthermore PWM switching frequency will also be reduced when  $V_{BATT}$  drops 60% below of the charge-full voltage.

### Thermal Foldback Function

The MP2636 implements thermal protection to prevent the thermal damage to the IC and the surrounding components. An internal thermal sense circuit and feedback loop automatically decreases the programmed charge current when the die-temperature reaches 120°C. This function is called the charge-current-thermal fold-back. Not only this function protects against thermal damage, it can also set the charge current based on requirements rather than worst-case conditions while ensuring safe operation. Furthermore, the part includes thermal shutdown protection where the ceases charging if the junction temperature rises to 150°C.

### Constant-Off-Time Control for Large Duty Charging Operation

The MP2636 has an internal 600kHz frequency oscillator for the switching frequency. Unlike the traditional fixed frequency, the MP2636 features a constant-off-time control to support constant-current charge even when the input voltage is very close to the battery voltage. As shown in the

Figure 13, the MP2636 continuously compares the high-side FET sense current with comp level, if the sense current doesn't reach the comp level within the original switching period, the next clock will be delayed until the sense current reaches the comp level. As a result the duty cycle is able to be extended as large as possible.

**Fully Operation Indication**

The MP2636 integrates indicators for the following conditions as shown in Table2.

The blinking frequency is,

$$F_{\text{Blinking}} = \frac{1(\mu\text{A})}{0.8 \times C_{\text{TMR}}(\mu\text{F})} \quad (9)$$

**Table 2 Indication in Each Operation Mode**

Operation		ACOK	CHG	BOOST
Charge Mode	In Charging	Low	Low	High
	End of Charge, Charging disabled, Battery OVP		High	
	NTC Fault, Timer Out		Blinking	
Boost Mode		High	High	Low
Sleep Mode		High	High	High



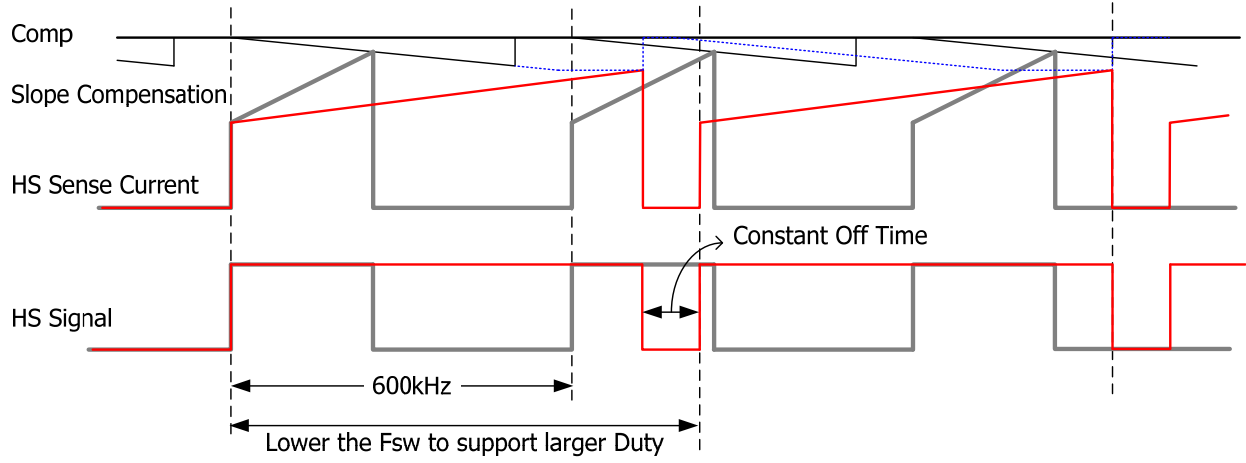

**Figure 13: Constant-Off-Time Operation Profile**

## BOOST MODE OPERATION

### Low Voltage Start-Up

The minimum battery voltage required to start up the circuit in boost mode is 2.9V. Initially, when  $V_{SYS} < V_{BATT}$ , the MP2636 works in down mode. In this mode, the synchronous P-MOSFET stops switching and its gate connects to  $V_{BATT}$  statically. The P\_MOSFET keeps off as long as the voltage across the parasitic  $C_{DS}$  ( $V_{SW}$ ) is lower than  $V_{BATT}$ . When the voltage across  $C_{DS}$  exceeds  $V_{BATT}$ , the synchronous P-MOSFET enters linear mode allowing the inductor current to decrease and flowing into the SYS pin. Once  $V_{SYS}$  exceeds  $V_{BATT}$ , the P-MOSFET gate is released and normal close-loop PWM operation is initiated. In boost mode, the battery voltage can drop to as low as 2.5V without affecting circuit operation.

### SYS Disconnect and Inrush Limiting

The MP2636 allows for true output disconnection by eliminating body diode conduction of the internal P-MOSFET rectifier.  $V_{SYS}$  can go to 0V during shutdown, drawing no current from the input source. It also allows for inrush current limiting at start-up, minimizing surge currents from the input supply. To optimize the benefit of output disconnect, avoid connecting an external Schottky diode between the SW and SYS pins.

Board layout is extremely critical to minimize voltage overshoot at the SW pin due to stray inductance. Keep the output filter capacitor as close as possible to the SYS pin and use very low ESR/ESL ceramic capacitors tied to a good ground plane.

### Boost Output Voltage Setting

In boost mode, the MP2636 programs the output voltage via the external resistor divider at FB pin, and provides built-in output over-voltage protection (OVP) to protect the device and other components against damage when  $V_{SYS}$  goes beyond 6V. Once the output over voltage occurs, the MP2636 turns off the boost converter. When the voltage at SYS pin drops to a normal level, the boost converter restarts as long as the MODE pin remains in active status.

### Boost Output Current Limiting

The MP2636 integrates a programmable output current limit function in boost mode. When the boost output current exceeds the programmable limit, the MP2636 will regulate the output current at this limit and the SYS voltage will start to drop down. The OLIM pin programs the current limit threshold up to 3.0A as the following equation:

$$I_{OLIM}(A) = \frac{2400 \times 0.92}{R_{OLIM}(k\Omega) \times RS1(m\Omega)} \quad (10)$$

### SYS Output Over-Current Protection

The MP2636 integrates three-phase output over-current protection.

**Phase one** (boost mode output current limit): when the output current exceeds the programmed output current limit, the output constant current loop controls the output current, the output current remains at its limit of  $I_{OLIM}$ , and  $V_{SYS}$  decreases.

**Phase two** (down mode): when  $V_{SYS}$  drops below  $V_{BATT}+100mV$  and the output current loop remains in control, the boost converter enters down mode and shutdown after a 120 $\mu s$  blanking time. Then the boost converter will try to restart after 1ms. At this time, the peak current limit will be cut by half.

**Phase three** (short circuit mode): when  $V_{SYS}$  drops below 3.8V (will be 2.1V during boost soft start), the boost converter shuts down immediately once the inductor current hits the fold-back peak current limit of the low side N-MOSFET. The boost converter can also recover automatically after a 1ms period. At this time, the peak current limit will be cut by half.

### Thermal Shutdown Protection

The thermal shutdown protection is also active in boost mode. Once the junction temperature rises higher than 150°C, the MP2636 enters thermal shutdown. It will not resume normal operation until the junction temperature drops below 120°C.

## TYPICAL APPLICATION CIRCUITS

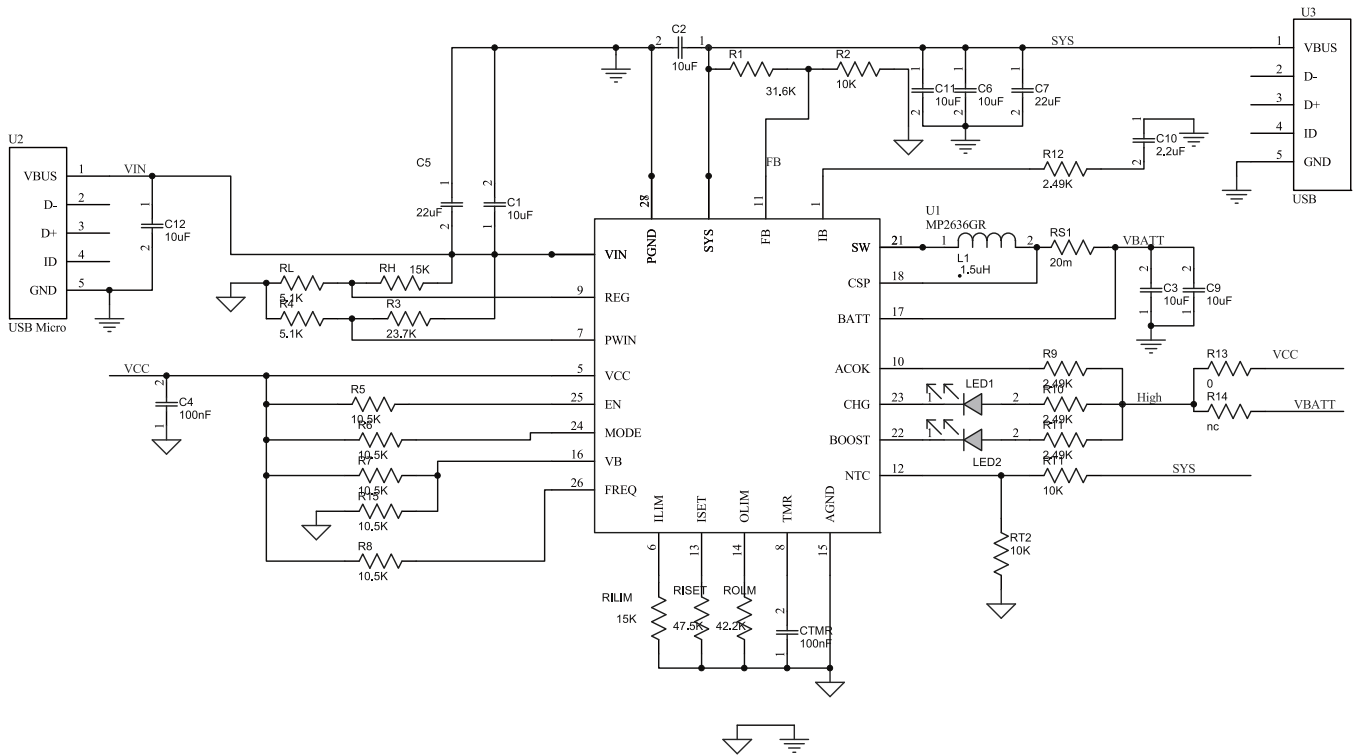

**Figure 14: The Detailed Application Circuit of MP2636**

## APPLICATION INFORMATION

### COMPONENT SELECTION

#### Setting the Charge Current in Charge Mode

In charge mode, both the external sense resistor, RS1, and the resistor R<sub>ISET</sub> connect to the ISET pin to set the charge current (I<sub>CHG</sub>) of the MP2636 (see the Typical Application circuit).

Given expected I<sub>CHG</sub> and RS1, R<sub>ISET</sub> can be calculated as:

$$R_{ISET}(\text{k}\Omega) = \frac{2400}{I_{CHG}(\text{A}) \times RS1(\text{m}\Omega)} \quad (11)$$

For example, for I<sub>CHG</sub>=2.5A, and RS1=20mΩ, R<sub>ISET</sub> = 48kΩ.

Given a 20mΩ RS1, the expected R<sub>ISET</sub> for typical charge current listed as below:

R <sub>ISET</sub> (kΩ)	Charge Current (A)
120	1.0
80	1.5
60	2.0
48	2.5
40	3.0

#### Setting the Input Current Limiting in Charge Mode

In charge mode, connect a resistor from the ILIM pin to AGND to program the input current limit. The relationship between the input current limit and setting resistor is as following:

$$R_{ILIM} = \frac{43.3}{I_{IN\_LIM}(\text{A}) + 0.05}(\text{k}\Omega) \quad (12)$$

For most applications, use R<sub>ILIM</sub> = 51kΩ (I<sub>USB\_LIM</sub>=900mA) for USB3.0 mode, and use R<sub>ILIM</sub> = 86.6kΩ (I<sub>USB\_LIM</sub>=500mA) for USB2.0 mode.

#### Setting the Input Voltage Range for Different Operation Modes

A resistive voltage divider from the input to PWIN pin determines the operating mode of MP2636.

$$V_{PWIN} = V_{IN} \times \frac{RL}{RH + RL}(\text{V}) \quad (13)$$

If the voltage on PWIN is higher than 0.8V, the MP2636 works in the charge mode. While the voltage is lower than 0.8V, the MP2636 will work in boost mode or sleep mode depending on the MODE status. (see Table 1).

#### Setting the Input Voltage Regulation in Charge Mode

In charge mode, connect a resistor divider from the IN pin to AGND with tapped to REG pin to program the input voltage regulation.

$$V_{IN\_R} = V_{REG} \times \frac{R3 + R4}{R4}(\text{V}) \quad (14)$$

With the given R4, R3 is:

$$R3 = \frac{V_{IN\_R} - V_{REG}}{V_{REG}} \times R4(\text{V}) \quad (15)$$

For a preset input voltage regulation value, say 4.75V, start with R4=5.1kΩ, R3 is 15kΩ.

#### NTC Function in Charge Mode

Figure 14 shows that an internal resistor divider sets the low temperature threshold (V<sub>TL</sub>) and high temperature threshold (V<sub>TH</sub>) at 66.6%·V<sub>SYS</sub> and 35%·V<sub>SYS</sub>, respectively. For a given NTC thermistor, select an appropriate R<sub>T1</sub> and R<sub>T2</sub> to set the NTC window.

$$\frac{V_{TL}}{V_{SYS}} = \frac{R_{T2} // R_{NTC\_Cold}}{R_{T1} + R_{T2} // R_{NTC\_Cold}} = TL = 66.6\% \quad (16)$$

$$\frac{V_{TH}}{V_{SYS}} = \frac{R_{T2} // R_{NTC\_Hot}}{R_{T1} + R_{T2} // R_{NTC\_Hot}} = TH = 35\% \quad (17)$$

Where R<sub>NTC\_Hot</sub> is the value of the NTC resistor at the upper bound of its operating temperature range, and R<sub>NTC\_Cold</sub> is its lower bound.

The two resistors, R<sub>T1</sub> and R<sub>T2</sub>, independently determine the upper and lower temperature limits. This flexibility allows the MP2636 to operate with most NTC resistors for different temperature range requirements. Calculate R<sub>T1</sub> and R<sub>T2</sub> as follows:

$$R_{T1} = \frac{R_{NTC\_Hot} \times R_{NTC\_Cold} \times (TL - TH)}{TH \times TL \times (R_{NTC\_Cold} - R_{NTC\_Hot})} \quad (18)$$

$$R_{T2} = \frac{R_{NTC\_Hot} \times R_{NTC\_Cold} \times (TL - TH)}{TH \times (1 - TL) \times R_{NTC\_Cold} - TL \times (1 - TH) \times R_{NTC\_Hot}} \quad (19)$$

For example, the NCP18XH103 thermistor has the following electrical characteristic:

At 0°C, R<sub>NTC\_Cold</sub> = 27.445kΩ;

At 50°C, R<sub>NTC\_Hot</sub> = 4.16kΩ.

Based on equation (18) and equation (19),  $R_{T1}=6.65k\Omega$  and  $R_{T2} = 25.63k\Omega$  are suitable for an NTC window between  $0^{\circ}C$  and  $50^{\circ}C$ . Chose approximate values: e.g.,  $R_{T1}=6.65k\Omega$  and  $R_{T2}=25.5k\Omega$ .

If no external NTC is available, connect  $R_{T1}$  and  $R_{T2}$  to keep the voltage on the NTC pin within the valid NTC window: e.g.,  $R_{T1} = R_{T2} = 10k\Omega$ .

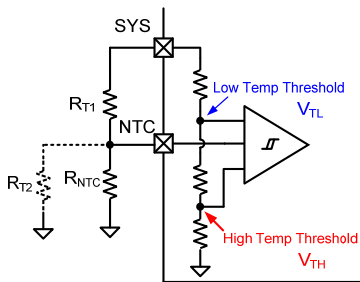

**Figure 14: NTC Function Block**

For convenience, an NTC thermistor design spreadsheet is also provided, please inquire if necessary.

**Setting the System Voltage in Boost Mode**

In the boost mode, the system voltage can be regulated to the value customer required between 4.2V to 6V by the resistor divider at FB pin as R1 and R2 in the typical application circuit.

$$V_{SYS} = 1.2V \times \frac{R1+R2}{R2} \quad (20)$$

where 1.2V is the voltage reference of SYS. With a typical value for R2, 10kΩ, R1 can be determined by:

$$R1 = R2 \times \frac{V_{SYS} - 1.2V}{1.2V} \quad (21)$$

For example, for a 5V system voltage, R2 is 10kΩ, and R1 is 31.6kΩ.

**Setting the Output Current Limit in Boost Mode**

In boost mode, connect a resistor from the OLIM pin to AGND to program the output current limit. The relationship between the output current limit and setting resistor is as follows:

$$I_{OLIM}(A) = \frac{2400 \times 0.92}{R_{OLIM}(k\Omega) \times RS1(m\Omega)} \quad (22)$$

The output current limit of the boost can be programmed up to 3.0A.

Given a 20mΩ RS1, the expected  $R_{OLIM}$  for typical output current limit listed as below:

$R_{OLIM}(k\Omega)$	Output Current (A)
220.8	1.0
147.2	1.5
110.4	2.0
90.3	2.5
73.6	3.0

**Selecting the Inductor**

Inductor selection trades off between cost, size, and efficiency. A lower inductance value corresponds with smaller size, but results in higher current ripple, higher magnetic hysteretic losses, and higher output capacitances. However, a higher inductance value benefits from lower ripple current and smaller output filter capacitors, but results in higher inductor DC resistance (DCR) loss.

Choose an inductor that does not saturate under the worst-case load condition.

**1. In Charge Mode**

When MP2636 works in charge mode (as a Buck Converter), estimate the required inductance as:

$$L = \frac{V_{IN} - V_{BATT}}{\Delta I_{L\_MAX}} \times \frac{V_{BATT}}{V_{IN} \times f_{SW}} \quad (23)$$

where  $V_{IN}$ ,  $V_{BATT}$ , and  $f_{SW}$  are the typical input voltage, the CC charge threshold, and the switching frequency, respectively.  $\Delta I_{L\_MAX}$  is the maximum peak-to-peak inductor current, which is usually designed at 30%-40% of the CC charge current.

With a typical 5V input voltage, 35% inductor current ripple at the corner point between trickle charge and CC charge ( $V_{BATT}=3V$ ,  $I_{CHG}=2.5A$ ), the inductance 2.2μH.

**2. In Boost Mode**

When the MP2636 is in Boost mode (as a Boost converter), the required inductance value is calculated as:

$$L = \frac{V_{BATT} \times (V_{SYS} - V_{BATT})}{V_{SYS} \times f_{SW} \times \Delta I_{L\_MAX}} \quad (24)$$

$$\Delta I_{L\_MAX} = 30\% \times I_{BATT(MAX)} \quad (25)$$

$$I_{BATT(MAX)} = \frac{V_{SYS} \times I_{SYS(MAX)}}{V_{BATT} \times \eta} \quad (26)$$

Where  $V_{BATT}$  is the minimum battery voltage,  $f_{SW}$  is the switching frequency, and  $\Delta I_{L\_MAX}$  is the peak-to-peak inductor ripple current, which is approximately 30% of the maximum battery current  $I_{BATT(MAX)}$ ,  $I_{SYS(MAX)}$  is the system current and  $\eta$  is the efficiency.

In the worst case where the battery voltage is 3V, a 30% inductor current ripple, and a typical system voltage ( $V_{SYS}=5V$ ), the inductance is 1.5 $\mu$ H when the efficiency is 90%.

For best results, use an inductor with an inductance of 2.2 $\mu$ H with a DC current rating that is not lower than the peak current of MOSFET

For higher efficiency, minimize the inductor's DC resistance.

### Selecting the Input Capacitor $C_{IN}$

The input capacitor  $C_{IN}$  reduces both the surge current drawn from the input and the switching noise from the device. The input capacitor impedance at the switching frequency should be less than the input source impedance to prevent high-frequency-switching current from passing to the input. For best results, use ceramic capacitors with X7R dielectrics because of their low ESR and small temperature coefficients. For most applications, a 22 $\mu$ F capacitor will be sufficient.

### Selecting the System Capacitor $C_{SYS}$

Select  $C_{SYS}$  based on the demand of the system current ripple.

#### 1. Charge Mode

The capacitor  $C_{SYS}$  acts as the input capacitor of the buck converter in charge mode. The input current ripple is:

$$I_{RMS\_MAX} = I_{SYS\_MAX} \times \frac{\sqrt{V_{TC} \times (V_{IN\_MAX} - V_{TC})}}{V_{IN\_MAX}} \quad (27)$$

#### 2. Boost Mode

The capacitor,  $C_{SYS}$ , is the output capacitor of boost converter.  $C_{SYS}$  keeps the system voltage ripple small and ensures feedback loop stability. The system current ripple is given by:

$$I_{RMS\_MAX} = I_{SYS\_MAX} \times \frac{\sqrt{V_{TC} \times (V_{SYS\_MAX} - V_{TC})}}{V_{SYS\_MAX}} \quad (28)$$

Since the input voltage is passes to the system directly,  $V_{IN\_MAX}=V_{SYS\_MAX}$ , both charge mode and boost mode have the same system current ripple.

For  $I_{SYS\_MAX}=2A$ ,  $V_{TC}=3V$ ,  $V_{IN\_MAX}=6V$ , the maximum ripple current is 1A. Select the system capacitors base on the ripple-current temperature rise not exceeding 10°C. For best results, use ceramic capacitors with X7R dielectrics with low ESR and small temperature coefficients. For most applications, use three 22 $\mu$ F capacitors.

### Selecting the Battery Capacitor $C_{BATT}$

$C_{BATT}$  is in parallel with the battery to absorb the high-frequency switching ripple current.

#### 1. Charge Mode

The capacitor  $C_{BATT}$  is the output capacitor of the buck converter. The output voltage ripple is then:

$$\Delta r_{BATT} = \frac{\Delta V_{BATT}}{V_{BATT}} = \frac{1 - V_{BATT} / V_{SYS}}{8 \times C_{BATT} \times f_{SW}^2 \times L} \quad (29)$$

#### 2. Boost Mode

The capacitor  $C_{BATT}$  is the input capacitor of the boost converter. The input voltage ripple is the same as the output voltage ripple from equation (28)

Both charge mode and boost mode have the same battery voltage ripple. The capacitor  $C_{BATT}$  can be calculated as:

$$C_{BATT} = \frac{1 - V_{TC} / V_{SYS\_MAX}}{8 \times \Delta r_{BATT\_MAX} \times f_{SW}^2 \times L} \quad (30)$$

To guarantee the  $\pm 0.5\%$  BATT voltage accuracy, the maximum BATT voltage ripple must not exceed 0.5% (e.g. 0.2%). The worst case occurs at the minimum battery voltage of the CC charge with the maximum input voltage.

For  $V_{SYS\_MAX}=6V$ ,  $V_{CC\_MIN}=V_{TC}=3V$ ,  $L=2.2\mu H$ ,  $f_{SW}=600kHz$ ,  $\Delta r_{BATT\_MAX} = 0.2\%$ ,  $C_{BATT}$  is 39 $\mu$ F.

Two pieces of 22 $\mu$ F ceramic with X7R dielectrics capacitor in parallel will suffice.

### PCB Layout Guide

PCB layout is very important to meet specified

noise, efficiency and stability requirements. The following design considerations can improve circuit performance:

1) Route the power stage adjacent to their grounds. Aim to minimize the high-side switching node (SW, inductor) trace lengths in the high-current paths.

Keep the switching node short and away from all small control signals, especially the feedback network.

Place the input capacitor as close as possible to the VIN and PGND pins. The local power input capacitors, connected from the SYS to PGND, must be placed as close as possible to the IC.

Place the output inductor close to the IC and connect the output capacitor between the inductor and PGND of the IC.

2) For high-current applications, the power pads for IN, SYS, SW, BATT and PGND should be connected to as many coppers planes on the board as possible. This improves thermal performance because the board conducts heat away from the IC.

3) The PCB should have a ground plane connected directly to the return of all components through vias (e.g., two vias per capacitor for power-stage capacitors, one via per capacitor for small-signal components). A star ground design approach is typically used to keep circuit block currents isolated (power-signal/control-signal), which reduces noise-coupling and ground-bounce issues. A single ground plane for this design gives good results.

4) Place ISET, OLIM and ILIM resistors very close to their respective IC pins.

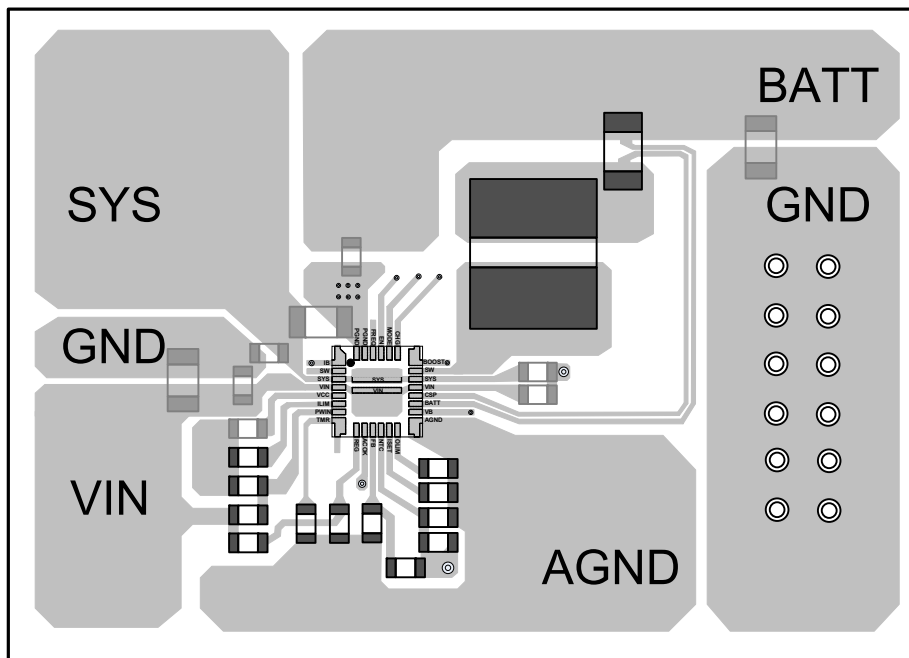

**Figure 15: PCB Layout Guide**

**PACKAGE INFORMATION**

**QFN-30 (4mmx4mm)**

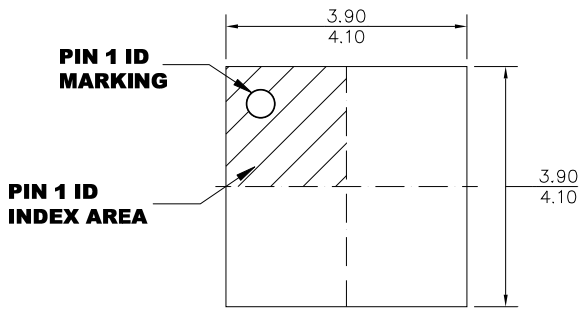

**TOP VIEW**

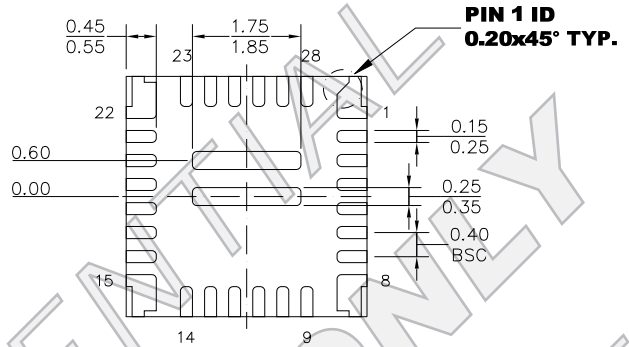

**BOTTOM VIEW**



**SIDE VIEW**

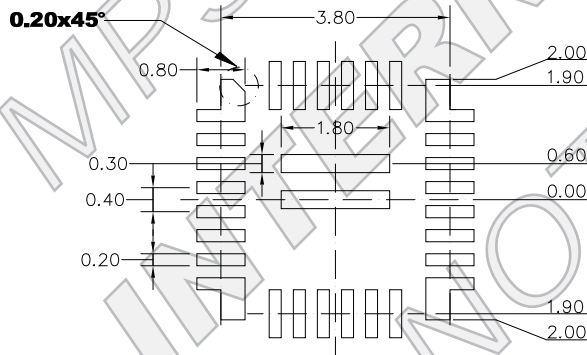

**RECOMMENDED LAND PATTERN**

**NOTE:**

- 1) ALL DIMENSIONS ARE IN MILLIMETERS.
- 2) EXPOSED PADDLE SIZE DOES NOT INCLUDE MOLD FLASH.
- 3) LEAD COPLANARITY SHALL BE 0.10 MILLIMETERS MAX.
- 4) DRAWING CONFORMS TO JEDEC MO-220.
- 5) DRAWING IS NOT TO SCALE.

**NOTICE:** The information in this document is subject to change without notice. Users should warrant and guarantee that third party Intellectual Property rights are not infringed upon when integrating MPS products into any application. MPS will not assume any legal responsibility for any said applications.





Компания «ЭлектроПласт» предлагает заключение долгосрочных отношений при поставках импортных электронных компонентов на взаимовыгодных условиях!

Наши преимущества:

- Оперативные поставки широкого спектра электронных компонентов отечественного и импортного производства напрямую от производителей и с крупнейших мировых складов;
- Поставка более 17-ти миллионов наименований электронных компонентов;
- Поставка сложных, дефицитных, либо снятых с производства позиций;
- Оперативные сроки поставки под заказ (от 5 рабочих дней);
- Экспресс доставка в любую точку России;
- Техническая поддержка проекта, помощь в подборе аналогов, поставка прототипов;
- Система менеджмента качества сертифицирована по Международному стандарту ISO 9001;
- Лицензия ФСБ на осуществление работ с использованием сведений, составляющих государственную тайну;
- Поставка специализированных компонентов (Xilinx, Altera, Analog Devices, Intersil, Interpoint, Microsemi, Aeroflex, Peregrine, Syfer, Eurofarad, Texas Instrument, Miteq, Cobham, E2V, MA-COM, Hittite, Mini-Circuits, General Dynamics и др.);

Помимо этого, одним из направлений компании «ЭлектроПласт» является направление «Источники питания». Мы предлагаем Вам помощь Конструкторского отдела:

- Подбор оптимального решения, техническое обоснование при выборе компонента;
- Подбор аналогов;
- Консультации по применению компонента;
- Поставка образцов и прототипов;
- Техническая поддержка проекта;
- Защита от снятия компонента с производства.



#### Как с нами связаться

**Телефон:** 8 (812) 309 58 32 (многоканальный)

**Факс:** 8 (812) 320-02-42

**Электронная почта:** [org@eplast1.ru](mailto:org@eplast1.ru)

**Адрес:** 198099, г. Санкт-Петербург, ул. Калинина, дом 2, корпус 4, литера А.