

NTS4409N, NVS4409N

Small Signal MOSFET

25 V, 0.75 A, Single, N-Channel,
ESD Protection, SC-70/SOT-323

Features

- Advance Planar Technology for Fast Switching, Low $R_{DS(on)}$
- Higher Efficiency Extending Battery Life
- AEC-Q101 Qualified and PPAP Capable – NVS4409N
- These Devices are Pb-Free and are RoHS Compliant

Applications

- Boost and Buck Converter
- Load Switch
- Battery Protection

MAXIMUM RATINGS ($T_J = 25^\circ\text{C}$ unless otherwise noted)

Rating		Symbol	Value	Unit
Drain-to-Source Voltage		V_{DSS}	25	V
Gate-to-Source Voltage		V_{GS}	± 8.0	V
Drain Current	$t < 5 \text{ s}$ $T_A = 25^\circ\text{C}$	I_D	0.75	A
Continuous Drain Current (Note 1)	Steady State $T_A = 25^\circ\text{C}$	I_D	0.7	A
			$T_A = 75^\circ\text{C}$	
Power Dissipation (Note 1)	Steady State	P_D	0.28	W
Power Dissipation (Note 1)	$t \leq 5 \text{ s}$	P_D	0.33	W
Pulsed Drain Current	$t_p = 10 \mu\text{s}$	I_{DM}	3.0	A
Operating Junction and Storage Temperature		T_J, T_{STG}	-55 to +150	$^\circ\text{C}$
Source Current (Body Diode) (Note 1)		I_S	0.3	A
Lead Temperature for Soldering Purposes (1/8" from case for 10 s)		T_L	260	$^\circ\text{C}$
ESD Rating – Machine Model			25	V

THERMAL RESISTANCE RATINGS

Rating	Symbol	Max	Unit
Junction-to-Ambient – Steady State (Note 1)	$R_{\theta JA}$	450	$^\circ\text{C}/\text{W}$
Junction-to-Ambient – $t \leq 5 \text{ s}$ (Note 1)	$R_{\theta JA}$	375	

Stresses exceeding Maximum Ratings may damage the device. Maximum Ratings are stress ratings only. Functional operation above the Recommended Operating Conditions is not implied. Extended exposure to stresses above the Recommended Operating Conditions may affect device reliability.

1. Surface mounted on FR4 board using 1 in sq pad size (Cu area = 1.127 in sq [1 oz] including traces).



ON Semiconductor®

<http://onsemi.com>

$V_{(BR)DSS}$	$R_{DS(on)}$ Typ	I_D Max
25 V	249 m Ω @ 4.5 V	0.75 A
	299 m Ω @ 2.7 V	

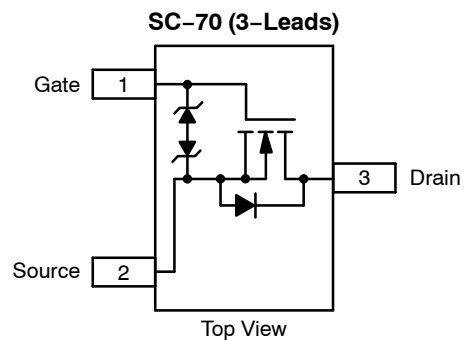

MARKING DIAGRAM & PIN ASSIGNMENT

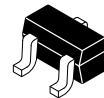

SC-70/SOT-323
CASE 419
STYLE 8

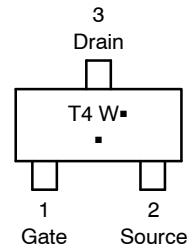

T4 = Device Code
W = Work Week
▪ = Pb-Free Package
(Note: Microdot may be in either location)

ORDERING INFORMATION

Device	Package	Shipping†
NTS4409NT1G	SOT-323 (Pb-Free)	3000 / Tape & Reel
NVS4409NT1G	SOT-323 (Pb-Free)	3000 / Tape & Reel

†For information on tape and reel specifications, including part orientation and tape sizes, please refer to our Tape and Reel Packaging Specification Brochure, BRD8011/D.

NTS4409N, NVS4409N

ELECTRICAL CHARACTERISTICS ($T_J = 25^\circ\text{C}$ unless otherwise noted)

Characteristic	Symbol	Test Condition	Min	Typ	Max	Unit
----------------	--------	----------------	-----	-----	-----	------

OFF CHARACTERISTICS

Drain-to-Source Breakdown Voltage	$V_{(BR)DSS}$	$V_{GS} = 0\text{ V}, I_D = 250\ \mu\text{A}$	25			V
Drain-to-Source Breakdown Voltage Temperature Coefficient	$V_{(BR)DSS}/T_J$			30		$\text{mV}/^\circ\text{C}$
Zero Gate Voltage Drain Current	I_{DSS}	$V_{GS} = 0\text{ V}, V_{DS} = 20\text{ V}$	$T_J = 25^\circ\text{C}$		0.5	μA
			$T_J = 70^\circ\text{C}$		2.0	
			$T_J = 125^\circ\text{C}$		5.0	
Gate-to-Source Leakage Current	I_{GSS}	$V_{DS} = 0\text{ V}, V_{GS} = 8.0\text{ V}$			100	nA

ON CHARACTERISTICS (Note 2)

Gate Threshold Voltage	$V_{GS(TH)}$	$V_{GS} = V_{DS}, I_D = 250\ \mu\text{A}$	0.65		1.5	V
Negative Threshold Temperature Coefficient	$V_{GS(TH)}/T_J$			-2.0		$\text{mV}/^\circ\text{C}$
Drain-to-Source On Resistance	$R_{DS(on)}$	$V_{GS} = 4.5\text{ V}, I_D = 0.6\text{ A}$		249	350	$\text{m}\Omega$
		$V_{GS} = 2.7\text{ V}, I_D = 0.2\text{ A}$		299	400	
		$V_{GS} = 4.5\text{ V}, I_D = 1.2\text{ A}$		260		
Forward Transconductance	g_{FS}	$V_{DS} = 5.0\text{ V}, I_D = 0.5\text{ A}$		0.5		S

CHARGES AND CAPACITANCES

Input Capacitance	C_{ISS}	$V_{GS} = 0\text{ V}, f = 1.0\text{ MHz}, V_{DS} = 10\text{ V}$		49	60	pF
Output Capacitance	C_{OSS}			22.4	30	
Reverse Transfer Capacitance	C_{RSS}			8.0	12	
Total Gate Charge	$Q_{G(TOT)}$	$V_{GS} = 4.5\text{ V}, V_{DS} = 15\text{ V}, I_D = 0.8\text{ A}$		1.2	1.5	nC
Threshold Gate Charge	$Q_{G(TH)}$			0.2		
Gate-to-Source Charge	Q_{GS}			0.28	0.50	
Gate-to-Drain Charge	Q_{GD}			0.3	0.40	

SWITCHING CHARACTERISTICS (Note 3)

Turn-On Delay Time	$t_{d(ON)}$	$V_{GS} = 4.5\text{ V}, V_{DS} = 15\text{ V}, I_D = 0.7\text{ A}, R_G = 51\ \Omega$		5.0	12	ns
Rise Time	t_r			8.2	8.0	
Turn-Off Delay Time	$t_{d(OFF)}$			23	35	
Fall Time	t_f			41	60	

DRAIN-SOURCE DIODE CHARACTERISTICS

Forward Diode Voltage	V_{SD}	$V_{GS} = 0\text{ V}, I_S = 0.6\text{ A}$	$T_J = 25^\circ\text{C}$		0.82	1.20	V
-----------------------	----------	---	--------------------------	--	------	------	---

2. Pulse Test: pulse width $\leq 300\ \mu\text{s}$, duty cycle $\leq 2\%$.
3. Switching characteristics are independent of operating junction temperatures.

NTS4409N, NVS4409N

TYPICAL PERFORMANCE CURVES ($T_J = 25^\circ\text{C}$ unless otherwise noted)

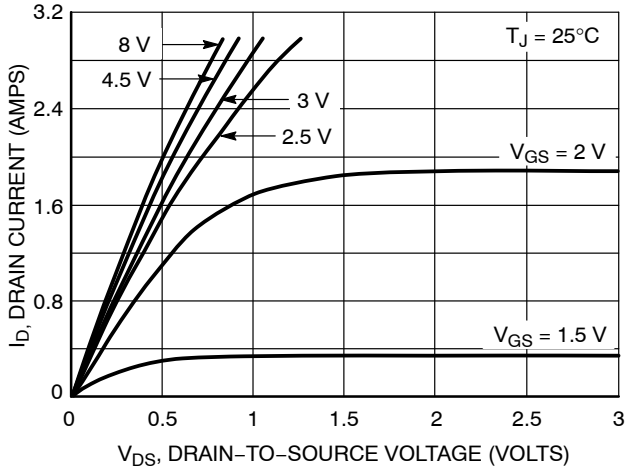

Figure 1. On-Region Characteristics

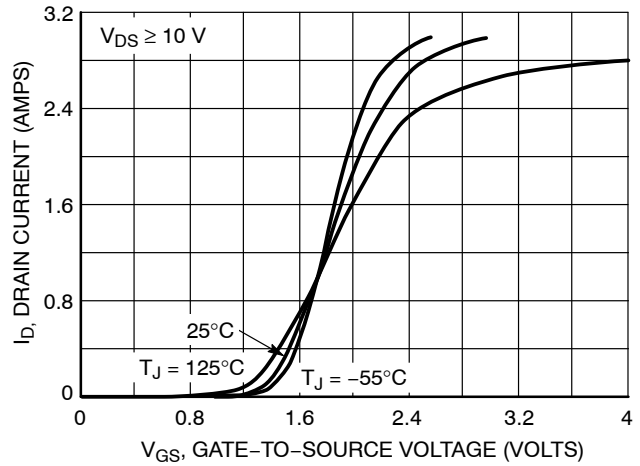

Figure 2. Transfer Characteristics

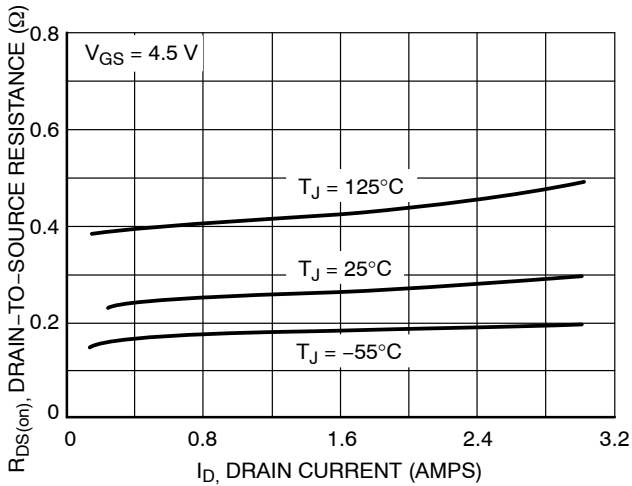

Figure 3. On-Resistance vs. Drain Current and Temperature

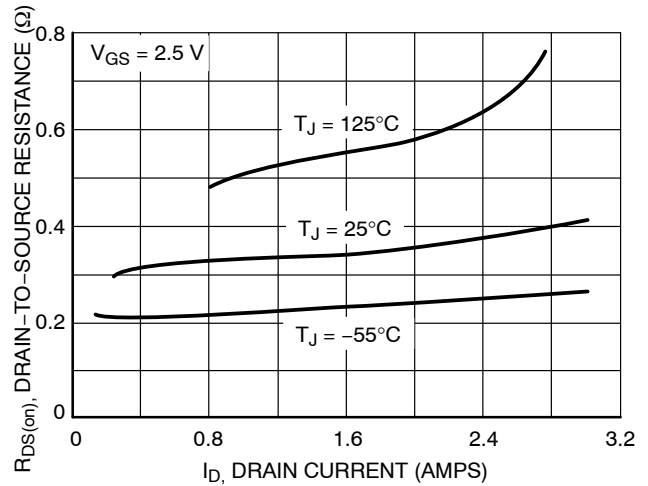

Figure 4. On-Resistance vs. Drain Current and Gate Voltage

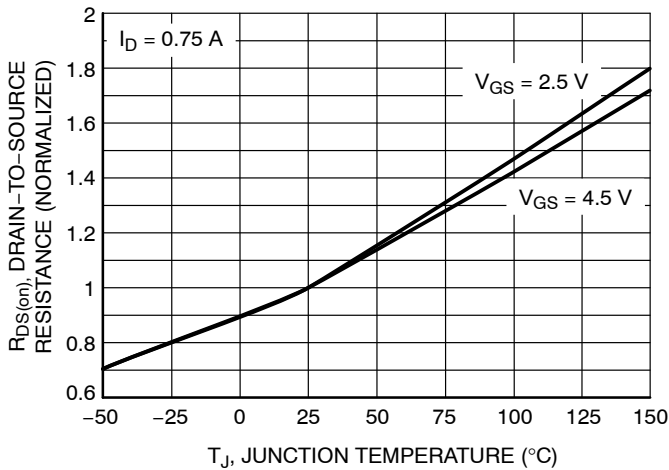

Figure 5. On-Resistance Variation with Temperature

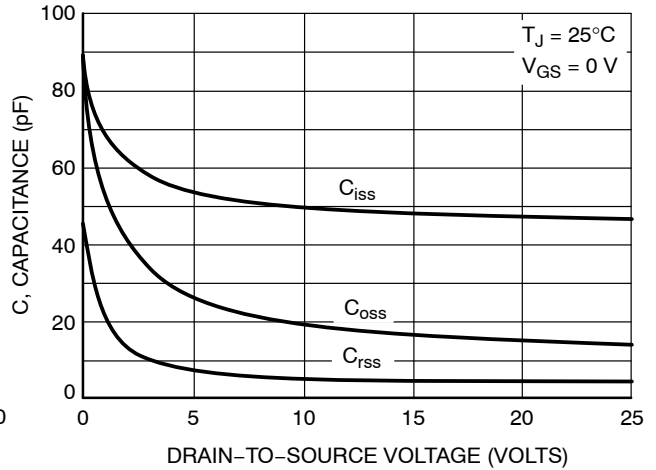

Figure 6. Capacitance Variation

NTS4409N, NVS4409N

TYPICAL PERFORMANCE CURVES ($T_J = 25^\circ\text{C}$ unless otherwise noted)

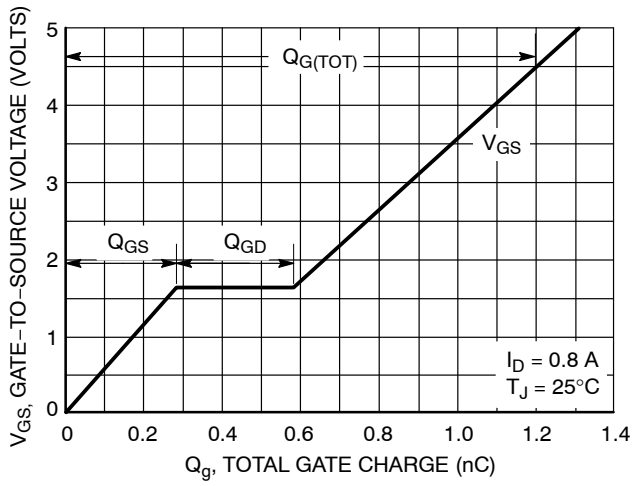

Figure 7. Gate-to-Source and Drain-to-Source Voltage vs. Total Charge

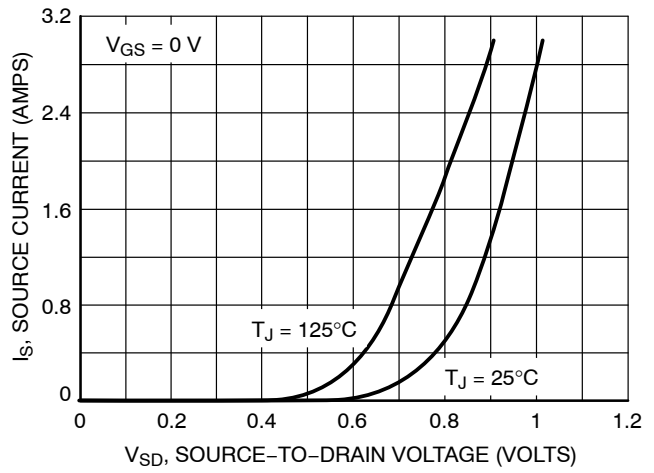
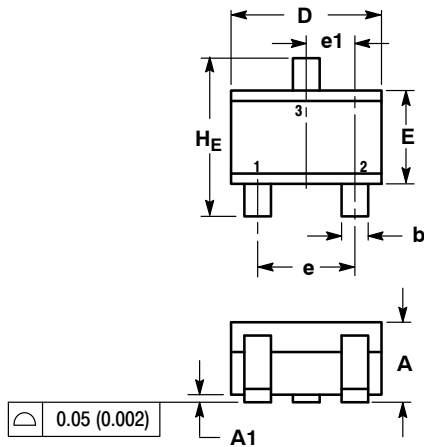

Figure 8. Diode Forward Voltage vs. Current

NTS4409N, NVS4409N

PACKAGE DIMENSIONS

SC-70 (SOT-323) CASE 419-04 ISSUE N



NOTES:

1. DIMENSIONING AND TOLERANCING PER ANSI Y14.5M, 1982.
2. CONTROLLING DIMENSION: INCH.

DIM	MILLIMETERS			INCHES		
	MIN	NOM	MAX	MIN	NOM	MAX
A	0.80	0.90	1.00	0.032	0.035	0.040
A1	0.00	0.05	0.10	0.000	0.002	0.004
A2	0.70 REF			0.028 REF		
b	0.30	0.35	0.40	0.012	0.014	0.016
c	0.10	0.18	0.25	0.004	0.007	0.010
D	1.80	2.10	2.20	0.071	0.083	0.087
E	1.15	1.24	1.35	0.045	0.049	0.053
e	1.20	1.30	1.40	0.047	0.051	0.055
e1	0.65 BSC			0.026 BSC		
L	0.20	0.38	0.56	0.008	0.015	0.022
HE	2.00	2.10	2.40	0.079	0.083	0.095

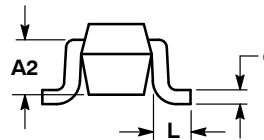

- STYLE 8:
PIN 1. GATE
2. SOURCE
3. DRAIN

SOLDERING FOOTPRINT*

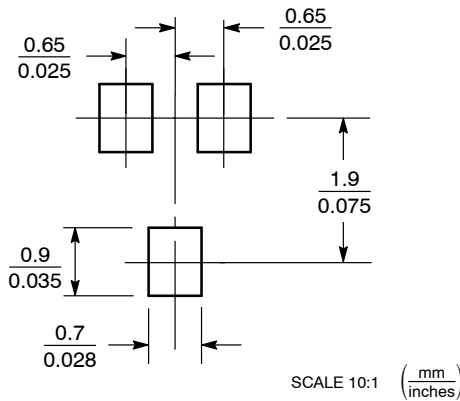

*For additional information on our Pb-Free strategy and soldering details, please download the ON Semiconductor Soldering and Mounting Techniques Reference Manual, SOLDERRM/D.

ON Semiconductor and are registered trademarks of Semiconductor Components Industries, LLC (SCILLC). SCILLC reserves the right to make changes without further notice to any products herein. SCILLC makes no warranty, representation or guarantee regarding the suitability of its products for any particular purpose, nor does SCILLC assume any liability arising out of the application or use of any product or circuit, and specifically disclaims any and all liability, including without limitation special, consequential or incidental damages. "Typical" parameters which may be provided in SCILLC data sheets and/or specifications can and do vary in different applications and actual performance may vary over time. All operating parameters, including "Typicals" must be validated for each customer application by customer's technical experts. SCILLC does not convey any license under its patent rights nor the rights of others. SCILLC products are not designed, intended, or authorized for use as components in systems intended for surgical implant into the body, or other applications intended to support or sustain life, or for any other application in which the failure of the SCILLC product could create a situation where personal injury or death may occur. Should Buyer purchase or use SCILLC products for any such unintended or unauthorized application, Buyer shall indemnify and hold SCILLC and its officers, employees, subsidiaries, affiliates, and distributors harmless against all claims, costs, damages, and expenses, and reasonable attorney fees arising out of, directly or indirectly, any claim of personal injury or death associated with such unintended or unauthorized use, even if such claim alleges that SCILLC was negligent regarding the design or manufacture of the part. SCILLC is an Equal Opportunity/Affirmative Action Employer. This literature is subject to all applicable copyright laws and is not for resale in any manner.

PUBLICATION ORDERING INFORMATION

LITERATURE FULFILLMENT:
Literature Distribution Center for ON Semiconductor
P.O. Box 5163, Denver, Colorado 80217 USA
Phone: 303-675-2175 or 800-344-3860 Toll Free USA/Canada
Fax: 303-675-2176 or 800-344-3867 Toll Free USA/Canada
Email: orderlit@onsemi.com

N. American Technical Support: 800-282-9855 Toll Free USA/Canada
Europe, Middle East and Africa Technical Support:
Phone: 421 33 790 2910
Japan Customer Focus Center
Phone: 81-3-5817-1050

ON Semiconductor Website: www.onsemi.com
Order Literature: <http://www.onsemi.com/orderlit>
For additional information, please contact your local Sales Representative



Компания «ЭлектроПласт» предлагает заключение долгосрочных отношений при поставках импортных электронных компонентов на взаимовыгодных условиях!

Наши преимущества:

- Оперативные поставки широкого спектра электронных компонентов отечественного и импортного производства напрямую от производителей и с крупнейших мировых складов;
- Поставка более 17-ти миллионов наименований электронных компонентов;
- Поставка сложных, дефицитных, либо снятых с производства позиций;
- Оперативные сроки поставки под заказ (от 5 рабочих дней);
- Экспресс доставка в любую точку России;
- Техническая поддержка проекта, помощь в подборе аналогов, поставка прототипов;
- Система менеджмента качества сертифицирована по Международному стандарту ISO 9001;
- Лицензия ФСБ на осуществление работ с использованием сведений, составляющих государственную тайну;
- Поставка специализированных компонентов (Xilinx, Altera, Analog Devices, Intersil, Interpoint, Microsemi, Aeroflex, Peregrine, Syfer, Eurofarad, Texas Instrument, Miteq, Cobham, E2V, MA-COM, Hittite, Mini-Circuits, General Dynamics и др.);

Помимо этого, одним из направлений компании «ЭлектроПласт» является направление «Источники питания». Мы предлагаем Вам помощь Конструкторского отдела:

- Подбор оптимального решения, техническое обоснование при выборе компонента;
- Подбор аналогов;
- Консультации по применению компонента;
- Поставка образцов и прототипов;
- Техническая поддержка проекта;
- Защита от снятия компонента с производства.



Как с нами связаться

Телефон: 8 (812) 309 58 32 (многоканальный)

Факс: 8 (812) 320-02-42

Электронная почта: org@eplast1.ru

Адрес: 198099, г. Санкт-Петербург, ул. Калинина, дом 2, корпус 4, литера А.