

PRODUCT SELECTOR GUIDE

AUGUST 2012



 **LATTICE**
SEMICONDUCTOR™

CONTENTS

■ Advanced Packaging	4
■ FPGA Products	6
■ CPLD Products	8
■ Mixed Signal Products	8
■ Intellectual Property and Reference Designs	10
■ Development Kits and Evaluation Boards	14
■ Programming Hardware	18
■ FPGA and CPLD Design Software	19
■ PAC-Designer® Design Software	19

Affordable Innovation

Lattice Semiconductor is committed to delivering value through innovative low cost, low power solutions. We're innovating every day to drive down costs and deliver greater value. From cost sensitive consumer electronics to leading edge communications equipment, designers are using Lattice products in a growing number of applications. We've shipped over a billion devices to customers worldwide and we understand that we must deliver cost effective solutions and excellent service in order to succeed.

FPGA, PLD and Mixed Signal Products

Lattice FPGA (Field Programmable Gate Array) solutions offer unique features, low power, and excellent value for FPGA designs. We are also the leading supplier of low-density CMOS PLDs, and our CPLD and SPLD solutions deliver an optimal fit for a variety of PLD design challenges.

Our Platform Manager™, Power Manager II and ispClock™ mixed signal product families feature a combination of programmable logic and programmable analog circuitry that allows system designers to reduce system cost and design time. These innovative products provide a fast and easy solution for integrating a wide range of power and clock management functions within a single integrated circuit. These products can replace numerous discrete components, reducing cost and conserving board space, while providing users with additional design flexibility and time-to-market benefits.

Software and Intellectual Property

Our Lattice Diamond® development tool suite, iCEcube2™ design software, PAC-Designer software, and IP core program allow design engineers to easily customize our devices for their unique system requirements.

Lattice Diamond software tools enable users to synthesize a design, perform analysis, debug, and download a logic configuration to our FPGA devices, while iCEcube2 software supports our iCE40 family of FGPA's. PAC-Designer software is used in the design of our mixed signal products.

Our IP core program, LatticeCORE™, provides pre-tested, reusable functions, allowing designers to focus on their unique system architectures. These IP cores provide industry-standard functions including PCI Express, DDR, Ethernet, CPRI, Serial RapidIO 2.1, SPI4, and embedded microprocessors. In addition, a number of independent IP providers have teamed with Lattice to offer additional high quality, reusable IP cores. Partners are selected for their industry leadership, high development standards, and commitment to customer support.

For more information go to LATTICESEMI.COM

Organic Flip Chip BGA

**1704-Ball
Organic fcBGA**
42.5 x 42.5 mm
3.25 mm height
1.00 mm pitch

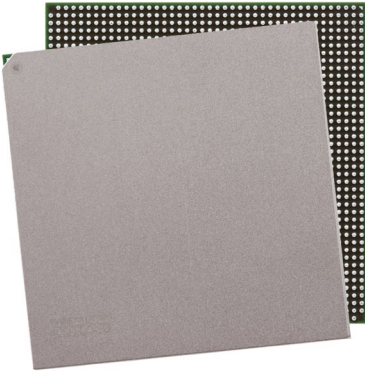

**1152-Ball
Organic fcBGA**
35 x 35 mm
3.50 mm height
1.00 mm pitch

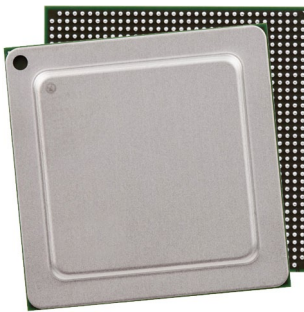

**1020-Ball
Organic fcBGA
Revision 2**
33 x 33 mm
3.25 mm height
1.00 mm pitch



Fine Pitch BGA

**1152-Ball fpBGA
1156-Ball fpBGA**
35 x 35 mm
2.60 mm height
1.00 mm pitch

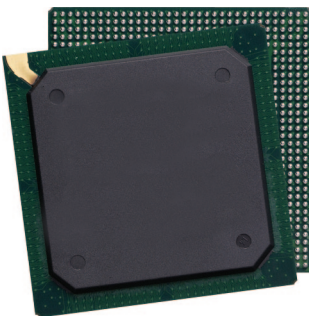

**868-Ball fpBGA
900-Ball fpBGA**
31 x 31 mm
2.60 mm height
1.00 mm pitch

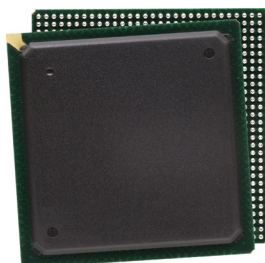

Fine Pitch BGA

**648-Ball fpBGA
672-Ball fpBGA**
27 x 27 mm
2.60 mm height
1.00 mm pitch

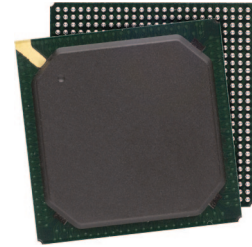

484-Ball fpBGA
23 x 23 mm
2.60 mm height
1.00 mm pitch

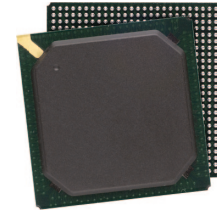

324-Ball ftBGA
19 x 19 mm
1.70 mm height
1.00 mm pitch

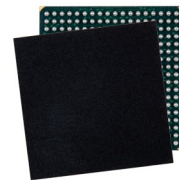

256-Ball ftBGA
17 x 17 mm
Option 1: 1.55 mm height
Option 2: 2.10 mm height
Option 3: 1.70 mm height
1.00 mm pitch

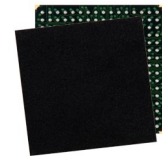

256-Ball fpBGA
17 x 17 mm
2.10 mm height
1.00 mm pitch

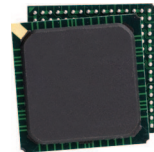

208-Ball ftBGA
17 x 17 mm
1.55 mm height
1.00 mm pitch

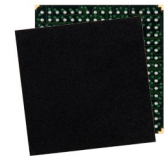

Chip Array BGA

332-Ball caBGA
17 x 17 mm
2.00 mm height
0.80 mm pitch

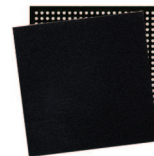

256-Ball caBGA
14 x 14 mm
1.70 mm height
0.80 mm pitch

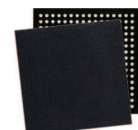

Note: Packages shown actual size. Height specification is max.

QFNS / QFN

64-Pin QFNS

9 x 9 mm
1.00 mm height
0.50 mm pitch



84-Pin QFNS

7 x 7 mm
1.00 mm height
0.50 mm pitch



48-Pin QFNS

7 x 7 mm
1.00 mm height
0.50 mm pitch



32-Pin QFNS

5 x 5 mm
1.00 mm height
0.50 mm pitch



32-Pin QFN

5 x 5 mm
0.60 mm height
0.50 mm pitch



24-Pin QFNS

4 x 4 mm
1.00 mm height
0.50 mm pitch



Ultra Chip Scale BGA

225-Ball ucBGA

7 x 7 mm
1.00 mm height
0.40 mm pitch



132-Ball ucBGA

6 x 6 mm
1.00 mm height
0.40 mm pitch



121-Ball ucBGA

5 x 5 mm
1.00 mm height
0.40 mm pitch



81-Ball ucBGA

4 x 4 mm
1.00 mm height
0.40 mm pitch



64-Ball ucBGA

4 x 4 mm
1.00 mm height
0.40 mm pitch



49-Ball ucBGA

3 x 3 mm
1.00 mm height
0.40 mm pitch



36-Ball ucBGA

2.5 x 2.5 mm
1.00 mm height
0.40 mm pitch



Chip Scale BGA

284-Ball csBGA

12 x 12 mm
1.00 mm height
0.50 mm pitch

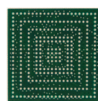

328-Ball csBGA

10 x 10 mm
1.50 mm height
0.50 mm pitch



100-Ball csBGA

132-Ball csBGA
8 x 8 mm
1.35 mm height
0.50 mm pitch



144-Ball csBGA

7 x 7 mm
1.10 mm height
0.50 mm pitch



56-Ball csBGA

6 x 6 mm
1.35 mm height
0.50 mm pitch



121-Ball csBGA

6 x 6 mm
1.00 mm height
0.50 mm pitch



81-Ball csBGA

5 x 5 mm
1.00 mm height
0.50 mm pitch



64-Ball csBGA

5 x 5 mm
1.10 mm height
0.50 mm pitch



TQFP/PQFP

208-Pin PQFP

28 x 28 mm (body)
4.10 mm height
0.50 mm pitch

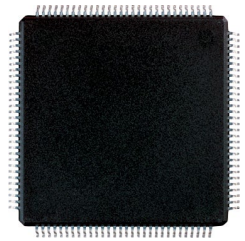

176-Pin TQFP

24 x 24 mm (body)
1.60 mm height
0.50 mm pitch

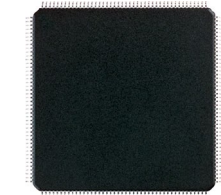

144-Pin TQFP

20 x 20 mm (body)
1.60 mm height
0.50 mm pitch



100-Pin TQFP

128-Pin TQFP
14 x 14 mm (body)
1.6 mm height
0.50 mm pitch (100 TQFP)
0.40 mm pitch (128 TQFP)

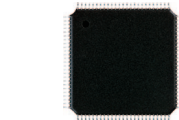

44-Pin TQFP

10 x 10 mm (body)
1.20 mm height
1.60 mm height
0.80 mm pitch

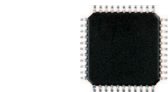

48-Pin TQFP

7 x 7 mm (body)
1.20 mm height
1.60 mm height
0.50 mm pitch

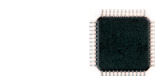

Wafer Level Chip Scale

25-Ball WLCSP

2.5 x 2.5 mm
0.62 mm height
0.40 mm pitch



FPGA Products

Volatile FPGA Families

Product Family	Device	LUTs	EBR SRAM		Distrib. RAM	sysDSP™ Blocks		SERDES		PLL + DLL	DDR Support	Boot Flash	Dual Boot	Bit-stream Encryption	Embedded Function Blocks	Process	Core Vcc														
			# of Blocks	Kbits		Kbits	18x18 Blocks	Multipliers	Max. Chan.								Max. Rate	1.2V	1.8 - 3.3V												
LatticeECP3™	LFE3-17EA	17K	38	700	36	12	24	4		2+2	DDR3 800 DDR2 533 DDR 400	External	✓	✓	65nm	✓															
	LFE3-35EA	33K	72	1,327	68	32	64	4		4+2																					
	LFE3-70EA	67K	240	4,420	145	64	128	12	3.2G	10+2																					
	LFE3-95EA	92K	240	4,420	188	64	128	12	3.2G	10+2																					
	LFE3-150EA	149K	372	6,850	303	160	320	16	3.2G	10+2																					
LatticeECP2/M	LFE2M20E/SE	19K	66	1,217	41	6	24	4		8+2	DDR2 533 DDR 400	External	✓	SE only	90nm	✓															
	LFE2M35E/SE	34K	114	2,101	71	8	32	4																							
	LFE2M50E/SE	48K	225	4,147	101	22	88	8	3.2G																						
	LFE2M70E/SE	67K	246	4,534	145	24	96	8	3.2G																						
	LFE2M100E/SE	95K	288	5,308	202	42	168	16	3.2G																						
	LFE2-6E/SE	6K	3	55	12	3	12												2+2	DDR2 533 DDR 400	External	✓	SE only	90nm	✓						
	LFE2-12E/SE	12K	12	221	24	6	24																								
	LFE2-20E/SE	21K	15	276	42	7	28																								
	LFE2-35E/SE	32K	18	332	64	8	32																								
	LFE2-50E/SE	48K	21	387	96	18	72																					4+2			
LFE2-70E/SE	68K	60	1,032	136	22	88			6+2																						
LatticeSC/M	LFSC3GA15E	15K	56	1,030	240				8	3.8G	8+12	DDR2 667 DDR 400	External		90nm	✓			4												
	LFSCM3GA15EP1																														
	LFSC3GA25E	25K	104	1,920	410				16																				6		
	LFSCM3GA25EP1																														
	LFSC3GA40E	40K	216	3,980	650				32																					10	
	LFSCM3GA40EP1																														
	LFSC3GA80E	80K	308	5,680	1,280				32																						10
	LFSCM3GA80EP1																														
LFSC3GA115E	115K	424	7,800	1,840																	12										
LFSCM3GA115EP1																															

1) S = Standard Power; L = Low Power.

Non-volatile FPGA Families

Product Family	Device	LUTs	EBR SRAM		Distrib. RAM	UFM	sysDSP™ Blocks		PLL + DLL	DDR Support	Configuration Memory	Dual Boot ²	Bit-stream Encryption	Embedded Function Blocks	Process
			# of Blocks	Kbits			Kbits	18x18 Blocks							
LatticeXP2™	LFXP2-5E	5K	9	166	10		3	12	2+0	DDR/2 400	Internal Flash	✓	✓	90nm	
	LFXP2-8E	8K	12	221	18		4	16	2+0						
	LFXP2-17E	17K	15	276	35		5	20	4+0						
	LFXP2-30E	29K	21	387	56		7	28	4+0						
	LFXP2-40E	40K	48	885	83		8	32	4+0						
NEW iCE40™	iCE40LP384	384								Internal NVCM	✓			40nm	
	iCE40LP640	640	8	32					1						
	iCE40LP1K	1280	16	64					1						
	iCE40LP4K	3520	20	80					2						
	iCE40LP8K	7680	32	128					2						
	iCE40HX640	640	8	32					1						
	iCE40HX1K	1280	16	64					1						
	iCE40HX4K	3520	20	80					2						
	iCE40HX8K	7680	32	128					2						
iCE40HX16K	15296	52	832					2							
MachXO2™	LCMXO2-256	256	0	0	2	0				DDR 266 DDR2 266 LPDDR266	Internal Flash	✓	I ² C (2) SPI (1) Timer (1)	65nm	
	LCMXO2-640	640	2	18	5	24									
	LCMXO2-640U	640	7	64	5	64			1+2						
	LCMXO2-1200	1280	7	64	10	64			1+2						
	LCMXO2-1200U	1280	8	74	10	80			1+2						
	LCMXO2-2000	2112	8	74	16	80			1+2						
	LCMXO2-2000U	2112	10	92	16	96			2+2						
	LCMXO2-4000	4320	10	92	34	96			2+2						
LCMXO2-7000	6864	26	240	54	256			2+2							
MachXO™	LCMXO256E	256			2.0					Internal Flash				130nm	
	LCMXO256C														
	LCMXO640E	640			6.1										
	LCMXO640C														
	LCMXO1200E	1200	1	9.2	6.4				1+0						
	LCMXO1200C														
	LCMXO2280E	2280	3	27.6	7.7				2+0						
LCMXO2280C															

1) Contact your Lattice sales representative for the support of 32 QFN packages for MachXO2. 2) Dual Boot supported with external boot Flash.

CPLD Products

Parameter	ispMACH® 4000ZE			
	4032ZE	4064ZE	4128ZE	4256ZE
Macrocells	32	64	128	256
Embedded Oscillator	✓	✓	✓	✓
t _{PD} (ns)	4.4	4.7	5.8	5.8
t _{CO} (ns)	3.0	3.2	3.8	3.8
t _S (ns)	2.2	2.5	2.9	2.9
f _{MAX} (MHz)	260	241	200	200
V _{CC} (Volts)	1.8	1.8	1.8	1.8
I/O Standard Support	1.8	2.5	3.3	
Typ. Standby Current	10 µA	11 µA	12 µA	13 µA
Package	I/Os + Inputs ¹			
Bare Die	✓	✓	✓	✓
48-pin TQFP	32 + 4	32 + 4		
64-ball csBGA	32 + 4	48 + 4		
64-ball ucBGA		48 + 4		
100-pin TQFP		64 + 10	64 + 10	64 + 10
132-ball ucBGA			96 + 4	
144-ball csBGA		64 + 10	96 + 4	108 + 14
144-pin TQFP			96 + 4	96 + 4

1) Pb-free only.

ispClock Products

Feature	ispClock5400D		ispClock5600A		ispClock5300S				
	5406D	5410D	5610A	5620A	5304S	5308S	5312S	5316S	5320S
Outputs	6	10	10	20	4	8	12	16	20
Input Operating Frequency Range	50 to 400MHz		8 to 400MHz		8 to 267MHz				
Output Operating Frequency Range	50 to 400MHz		4 to 400MHz		5 to 267MHz				
VCO Operation	400 to 800MHz		320 to 800MHz		160 to 400MHz				
Spread Spectrum Compatibility	Yes		Yes		Yes				
Single-Ended Fan-out Buffer Interfaces	None		LVTTTL, LVCMOS, HSTL, eHSTL, SSTL		LVTTTL, LVCMOS, HSTL, eHSTL, SSTL				
Single-Ended Clock Reference and Feedback Interfaces	LVCMOS		LVTTTL, LVCMOS, SSTL, HSTL		LVTTTL, LVCMOS, HSTL, eHSTL, SSTL				
Differential Fan-out Buffer Interfaces	LVDS, LVPECL, HSTL, SSTL, HCSSL, MLVDS		SSTL, HSTL, LVDS, LVPECL		None				
Differential Clock Reference and Feedback Interfaces	LVDS, LVPECL, HSTL, SSTL, HCSSL, MLVDS		HSTL, SSTL, LVDS, LVPECL		LVDS, LVPECL, HSTL, SSTL				
Type of PLL Feedback	Internal/External		Internal/External		External				
M, N Dividers	None		Count from 1 to 40		None				
Number of V Dividers	4		5		3				
V Divider Count Range	2 to 16 (in powers of 2)		2 to 80 (in steps of 2)		1 to 32 (in powers of 2)				
Maximum Cycle-Cycle Jitter	29ps (peak-peak)		70ps (peak-peak)		70ps (peak-peak)				
Maximum Period Jitter (RMS)	2.5ps		12ps		12ps				
Maximum Phase Jitter (RMS)	6ps Typ.		50ps		50ps				
Maximum Static Phase Offset	-5ps to 95ps		-100ps to 200ps		-40ps to 100ps				
Frequencies Generated	4		5		3				
Programmable Phase Skew	156ps to 12ns		156ps to 12ns		156ps to 5ns				
Programmable Time Skew	0 to 288ps		None		None				
Fan-out Buffer Mode	Yes		No		Yes				
Programmable Termination	None		40 to 70 & 20 Setting		40 to 70 & 20 Setting				

Platform and Power Management Products

Integrated Platform and Power Management Functions (Shown in ICs)

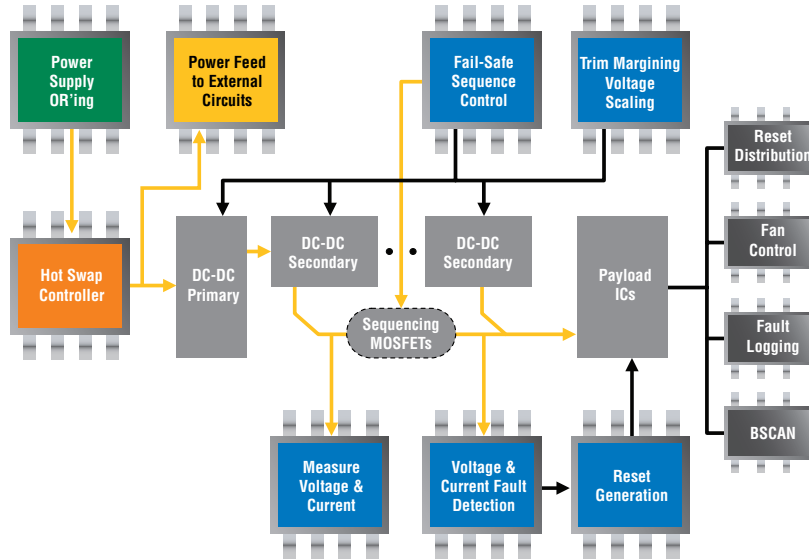

Platform Manager and Power Manager II Applications Cross Reference

	Function	POWR 6AT6	ProcessorPM	POWR 607	POWR 1014	POWR 1014A	POWR 1220AT8	LPTM 10-1247	LPTM 12-12107
Hot Swap	-48V Hot-Swap Controller (Payload - isolated)			✓					
	+12 / 24V Hot swap Controller			✓	✓	✓	✓	✓	✓
	Low Voltage Positive Supply Hot-Swap Controller			✓					
Power Feed to External Systems	-48V Supply Feed			✓					
	+12/24V Supply Feed			✓	✓	✓	✓	✓	✓
Redundant Supply Selection	-48V Supply OR'ing using MOSFET			✓					
	+12/24V Supply OR'ing using MOSFET			✓	✓	✓	✓	✓	✓
Payload Power Management	Reset Generation		✓	✓	✓	✓	✓	✓	✓
	Voltage Supervision		✓	✓	✓	✓	✓	✓	✓
	Watchdog Timer		✓	✓	✓	✓	✓	✓	✓
	Voltage Monitoring and Supply Sequencing		✓	✓	✓	✓	✓	✓	✓
	Fail Safe Sequencing						✓	✓	✓
	Voltage Measurement Using ADC	✓					✓	✓	✓
	Power Supply Margining and Trimming	✓					✓	✓	✓
Digital Management Functions	Power Supply Voltage Scaling	✓						✓	✓
	Reset Distribution							✓	✓
	Fan Control							✓	✓
	Boundary Scan							✓	✓
	Fault Log							✓	✓

Platform Manager and Power Manager II Device Selector Guide

Parameter	Power Manager II					Platform Manager	
	POWR6AT6	ProcessorPM™ - POWR605	POWR607	POWR1014/A	POWR1220AT8	LPTM10-1247	LPTM10-12107
Precision Voltage Monitors (Typ.)	6 (0.2%)	6 (0.5%)	6 (0.5%)	10 (0.3%)	12 (0.2%)	12 (0.2%)	12 (0.2%)
Comparators		6	6	20	24	24	24
CPLD Macrocells		16	16	24	48	48	48
FPGA LUTs						640	640
Digital I/O						31	91
Dedicated Outputs	6 trim outputs	5	7	14	20 & 8 trim outputs	16 & 6 trim outputs	16 & 8 trim outputs
N-Channel FET Drivers			2	2	4	4	4
Trim Outputs (DAC)	6			None	8	6	8
ADC (10-Bit)	Yes	No	No	Yes*	Yes	Yes	Yes
Package	32-pin QFNS	24-pin QFNS	32-pin QFNS	48-pin TQFP	100-pin TQFP	128-pin TQFP	208-ball ftBGA

* ispPAC-POWR1014A Only

Lattice IP Cores and Reference Designs

LatticeCORE IP Cores

For a complete listing of IP cores from Lattice and its 3rd party partners, please go to www.latticesemi.com/ip.

	IP Core	ECP3	ECP2M	ECP2	SC ¹	XP2	MachX02
Communications	10 Gigabit Ethernet MAC	✓	✓	✓	✓		
	10 Gigabit Ethernet MAC w/HiGig Interface				✓		
	2.5 Gb Ethernet MAC	✓					
	2.5 Gb Ethernet PCS	✓					
	CPRI	✓	✓		✓		
	OBSAI RP3		✓		✓		
	Serial Rapid IO (SRIO)	✓	✓				
	SFI5				✓		
	SGMII and Gigabit Ethernet PCS	✓	✓		✓		
	SPI4.2	✓			✓		
	Triple Speed 10/100/1G Ethernet MAC	✓	✓	✓	✓	✓	
	XAU1	✓	✓				
Connectivity	Display Interface Multiplexer						✓
	DVB-ASI	✓					
	JESD204A	✓					
	Multi-Rate SDI PHY		✓				
	PCI Express Root Complex Lite	✓	✓				
	PCI Express x1 Endpoint	✓	✓				
	PCI Express x4 Endpoint	✓	✓				
	PCI Master/Target 32-bit	✓	✓	✓	✓	✓	✓
	PCI Master/Target 64-bit	✓	✓	✓	✓	✓	
	PCI Target 32-bit	✓	✓	✓	✓	✓	✓
	PCI Target 64-bit	✓	✓	✓	✓	✓	
	PCS Pipe	✓	✓				
Tri-Rate Serial Digital Interface (SDI) PHY	✓						
Digital Signal Processing	2D Edge Detector	✓	✓	✓		✓	
	2D FIR Filter	✓	✓	✓		✓	
	2D Scaler	✓	✓	✓		✓	
	Advanced FIR Filter		✓	✓		✓	
	Block Convolutional Encoder	✓	✓	✓	✓	✓	
	Block Viterbi Decoder	✓	✓	✓	✓	✓	
	Cascaded Integrator-Comb (CIC) Filter	✓	✓	✓	✓	✓	
	Color Space Converter	✓	✓	✓	✓	✓	
	CORDIC	✓	✓	✓	✓	✓	
	Correlator		✓	✓	✓	✓	
	Deinterlacer	✓	✓	✓		✓	
	Distributed Arithmetic (DA) FIR Filter	✓	✓	✓	✓	✓	
	Dynamic Block Reed-Solomon Decoder	✓	✓	✓	✓	✓	
	Dynamic Block Reed-Solomon Encoder	✓	✓	✓	✓	✓	
	FFT Compiler	✓	✓	✓		✓	
	FIR Filter Generator	✓	✓	✓		✓	
	Gamma Corrector	✓	✓	✓		✓	
	Interleaver/De-interleaver		✓	✓	✓	✓	
	Median Filter	✓	✓	✓		✓	
	Numerically-Controlled Oscillator	✓	✓	✓	✓	✓	
Turbo Decoder		✓	✓	✓	✓		
Turbo Encoder		✓	✓	✓	✓		
Processor, Controller & Peripheral	DDR SDRAM Controller - Pipelined	✓	✓	✓	✓	✓	✓
	DDR2 SDRAM Controller - Pipelined	✓	✓	✓	✓	✓	✓
	DDR3 PHY	✓					
	DDR3 SDRAM Controller	✓					
	LatticeMico32 - Embedded Processor		✓	✓	✓	✓	
	LatticeMico8 - Embedded Microcontroller	✓	✓	✓	✓	✓	✓
	LPDDR SDRAM Controller						✓
	Scatter Gather DMA	✓	✓	✓	✓	✓	
	Soft Error Detection				✓		
Video Frame Buffer	✓	✓	✓		✓		

1. LatticeSCM™ MACO®-based IP cores are not included in this table.

IP Suites

Lattice IP Suites provide many of the functions required to develop a total solution for common FPGA applications. In addition, multiple Lattice FPGA families are supported with each IP Suite, so designers can develop solutions across multiple Lattice families, taking advantage of the best features of each. The following table summarizes which IP cores are included in each IP Suite, and which FPGA families are supported.

	IP Core	ECP3	ECP2/M	SC/M	XP2	XO2	XO	Suite (One Year Node Locked Subscription)	Annual License Node Locked Renewal (After First Year)
Value Suite	DDR3 Controller	✓						Order #: DS-VAL-ST-U1	Order #: DS-VAL-ST-UR1
	DDR2 Controller	✓	✓	✓	✓	✓			
	DDR Controller	✓	✓	✓	✓	✓	✓		
	LPDDR Controller					✓			
	FFT Compiler	✓	✓		✓				
	FIR Filter	✓	✓		✓				
	Tri-Speed Ethernet MAC	✓	✓	✓	✓				
PCI Express Suite	PCI Express Endpoint x1	✓	✓					Order #: DS-PCIE-ST-U1	Order #: DS-PCIE-ST-UR1
	PCI Express Endpoint x4	✓	✓						
	PCI Express Root Complex Lite x1	✓	✓						
	PCI Express Root Complex Lite x4	✓	✓						
	Scatter-Gather DMA Controller	✓	✓	✓					
	PCI Master/Target 32-bit	✓	✓	✓	✓	✓	✓		
	PCI Master/Target 64-bit	✓	✓	✓	✓				
	PCI Target 32-bit	✓	✓	✓	✓	✓	✓		
	PCI Target 64-bit	✓	✓	✓	✓				
	DDR3 Controller	✓							
Ethernet Suite	Triple Speed Ethernet MAC	✓	✓	✓	✓			Order #: DS-ETH-ST-U1	Order #: DS-ETH-ST-UR1
	SGMII & Gb Ethernet PCS	✓	✓	✓					
	10 Gb+ Ethernet MAC	✓	✓	✓					
	XAUI	✓	✓						
	SPI-4.2	✓		✓					
	Scatter-Gather DMA Controller	✓	✓	✓					
	DDR3 Controller	✓							
Digital Signal Processing (DSP) Design Suite	Block Convolutional Encoder	✓	✓	✓	✓			Order #: DS-DSP-ST-U1	Order #: DS-DSP-ST-UR1
	Block Viterbi Decoder	✓	✓	✓	✓				
	CIC Filter	✓	✓	✓	✓				
	CORDIC	✓	✓	✓	✓				
	DA-FIR Filter	✓	✓	✓	✓				
	Dynamic Block RS Decoder	✓	✓	✓	✓				
	Dynamic Block RS Encoder	✓	✓	✓	✓				
	FFT Compiler	✓	✓		✓				
	FIR Filter	✓	✓		✓				
	Interleaver/De-Interleaver	✓	✓	✓	✓				
	Num. Cont. Oscillator (NCO)	✓	✓	✓	✓				
	Turbo Decoder		✓	✓	✓				
	Turbo Encoder		✓	✓	✓				
Video and Display Suite	2D Edge Detector	✓	✓		✓			Order #: DS-VDS-ST-U1	Order #: DS-VDS-ST-UR1
	2D FIR Filter	✓	✓		✓				
	2D Scaler	✓	✓		✓				
	Color Space Converter	✓	✓	✓	✓				
	Median Filter	✓	✓		✓				
	Tri-rate SDI PHY	✓							
	Deinterlacer	✓	✓		✓				
	DVB ASI	✓							
	DDR3 Controller	✓							
	DDR2 Controller	✓	✓	✓	✓	✓			
DDR Controller	✓	✓	✓	✓	✓	✓			

LatticeECP3, MachXO2, MachXO and LatticeXP2 Reference Designs

Name	Reference Design Number						Format	
		LatticeECP3	MachXO2	MachXO	LatticeXP2	WISHBONE Compatible	Verilog	VHDL
7:1 LVDS Video Interface	RD1030	✓					✓	✓
8b/10b Encoder/Decoder	RD1012	✓					✓	✓
ADC Interface	RD1089	✓					✓	✓
Arbitration and Switching Between Bus Masters	RD1067			✓	✓		✓	✓
BSCAN - Multiple Scan Port Addressable Buffer (BSCAN1)	RD1001			✓	✓			
BSCAN - Multiple Scan Port Linker (BSCAN 2)	RD1002	✓		✓	✓			
CompactFlash Controller	RD1040		✓	✓	✓	✓	✓	✓
Control Link Serial Interface	RD1051		✓	✓	✓		✓	✓
Cyclic Redundancy Check	RD1105		✓	✓			✓	✓
Display Interface	RD1093		✓				✓	
Fast Page Mode DRAM Controller	RD1014		✓	✓	✓		✓	✓
Flash Memory Controller with Wear Leveling	RD1102		✓	✓			✓	
FPGA Loader	AN8077			✓				
GPIO Expander	RD1065			✓	✓		✓	✓
HDLC Controller	RD1038			✓	✓		✓	✓
HDMI/DVI Multimedia Interface	RD1097	✓					✓	✓
I ² C (Inter-Integrated Circuit) Bus Controller for Serial EEPROMs	RD1006		✓	✓	✓		✓	✓
I ² C (Inter-Integrated Circuit) Bus Master	RD1046	✓	✓	✓	✓	✓	✓	✓
I ² C (Inter-Integrated Circuit) Bus Master	RD1005	✓		✓	✓			✓
I ² C (Inter-Integrated Circuit) Slave / Peripheral	RD1054	✓		✓	✓		✓	✓
I ² C Slave to SPI Master Bridge	RD1094			✓			✓	✓
I2S Controller	RD1101		✓	✓			✓	✓
IDE/ATA Interface Controller	RD1095			✓		✓	✓	
LCD Controller	RD1053		✓	✓	✓	✓	✓	✓
LED/OLED Driver	RD1103		✓	✓			✓	
LPC (Low Pin Count) Bus Controller	RD1049	✓	✓	✓	✓		✓	✓
MDIO Peripheral	RD1074	✓		✓		✓	✓	✓
Memory Stick PRO Host Interface	RD1109		✓			✓	✓	
NAND Flash Memory Controller	RD1055		✓	✓	✓		✓	✓
NOR Flash Memory Controller	RD1087		✓	✓		✓	✓	✓
PCI to NOR Flash Interface	RD1050			✓	✓		✓	✓
PCI Target 32-bit/33MHz	RD1008	✓		✓	✓		✓	✓
PCI/WISHBONE Bridge	RD1045	✓		✓	✓	✓	✓	✓
Power Management Bus (PMBus)	RD1100		✓	✓			✓	✓
PWM Fan Controller	RD1060		✓	✓	✓	✓	✓	✓
Read and Write Usercode	RD1041			✓			✓	✓
RGMII to GMII Bridge	RD1022	✓					✓	✓
SD Flash Controller	RD1048			✓	✓	✓	✓	
SD Flash Controller Using SD Bus	RD1088	✓	✓	✓			✓	
SDR SDRAM Controller – Advanced	RD1010	✓	✓	✓	✓		✓	✓
Simple Sigma-Delta ADC	RD1066		✓	✓	✓		✓	✓
Single Wire Interface	RD1099		✓	✓			✓	
SM Bus Controller	RD1098		✓	✓			✓	✓
SPI GPIO Expander	RD1073			✓			✓	
SPI Slave to PWM Generation	RD1107		✓			✓	✓	
SPI (Serial Peripheral Interface) Controller	RD1044		✓	✓	✓	✓	✓	✓
SPI (Serial Peripheral Interface) Peripheral	RD1075			✓			✓	✓
Sub-LVDS To Parallel Sensor Bridge	RD1122	✓					✓	✓
Three Wire Power Supply Fault Logging	RD1062			✓	✓		✓	✓
UART (Universal Asynchronous Receiver/Transmitter)	RD1011			✓	✓			✓
UART (Universal Asynchronous Receiver/Transmitter)	RD1042		✓	✓	✓	✓	✓	✓
Wake on LAN	RD1096			✓			✓	✓

ispMACH 4000 Reference Designs

Name	Reference Design Number	WISHBONE Compatible	Format			Included in Development Kit
			Verilog	VHDL	BLIF NGO	Pico
8b/10b Encoder/Decoder	RD1012				✓	
Arbitration and Switching Between Bus Masters	RD1067		✓	✓		
Fast Page Mode DRAM Controller	RD1014		✓			
GPIO Expander	RD1065		✓	✓		
HDLC Controller	RD1009				✓	
I ² C (Inter-Integrated Circuit) Bus Controller for Serial EEPROMs	RD1006	✓	✓		✓	
I ² C (Inter-Integrated Circuit) Bus Master	RD1005	✓			✓	✓
I ² C (Inter-Integrated Circuit) Slave / Peripheral	RD1054	✓				✓
LPC (Low Pin Count) Bus Controller	RD1049	✓	✓		✓	
Multiple Scan Port Addressable Buffer (BSCAN1)	RD1001	✓				
Multiple Scan Port Linker (BSCAN 2)	RD1002				✓	
PCI Target 32-bit/33MHz	RD1008		✓	✓		
PWM Fan Controller	RD1060		✓	✓		
Read and Write Usercode	RD1041		✓	✓		
SDR SDRAM Controller - Advanced	RD1010	✓	✓		✓	
SPI GPIO Expander	RD1073		✓			
SPI (Serial Peripheral Interface) Controller - WISHBONE Compatible	RD1044	✓	✓	✓		
SPI (Serial Peripheral Interface) Peripheral	RD1075	✓	✓		✓	
UART (Universal Asynchronous Receiver/Transmitter)	RD1011	✓				
Wake on LAN	RD1096		✓	✓		

Mixed Signal Reference Designs

Name	Reference Design Number	Format	Included in Development Kit			
			Power Manager II Hercules	Platform Manager	ProcessorPM	ispClock 5400D
5V and 3.3V Hot Swap Controller	RD1057	PAC-Designer	✓			
Supervisor, WDT and Reset Generation with ProcessorPM	RD1056	PAC-Designer	✓		✓	
Redundant Power Supply Management	RD1064	PAC-Designer	✓			
12V Hot Swap Control	RD1068	PAC-Designer	✓			
AMC Module Power Management	RD1070	PAC-Designer				
Voltage Monitoring for Fault Logging	RD1072	PAC-Designer	✓			
Single-Ended Clock Source from ispClock5400D Differential Clock Buffers	RD1069	PAC-Designer				✓
Temperature Monitor using Platform Manager	RD1080	VHDL				
Fault Logging using Platform Manager	RD1077	VHDL		✓		
BSCAN1 - Multiple Scan Port Addressable Buffer	RD1001	VHDL				
BSCAN2 - Multiple Scan Port Linker	RD1002	VHDL				
Enhanced Closed-Loop Trim with I2C Control	RD1078	VHDL		✓		
GPIO Expander	RD1065	VHDL				
I ² C Master Controller	RD1005	VHDL				
I ² C Slave/Peripheral	RD1054	VHDL				
I ² C Slave to SPI Master Bridge	RD1094	VHDL				
Long Delay Timers	RD1079	VHDL		✓		
Power Management Bus (PMBus)	RD1100	VHDL				
PWM Fan Controller	RD1060	VHDL				
SPI GPIO Expander	RD1073	VHDL				
Serial Peripheral Interface (SPI)	RD1075	VHDL				
Universal Asynchronous Receiver/Transmitter	RD1011	VHDL				
Three Wire Power Supply Fault Logging	RD1062	VHDL				
Distributed Power Management	RD1128					
Fail-Safe Sequencing During Field Updates With Platform Manager	RD1129					
Scalable Centralized Power Management With Field Update Support	RD1130					

LatticeECP3 Versa Development Kit

Industry's lowest cost platform for designing PCI Express and Gigabit Ethernet based systems. The kit includes free demos and reference designs.

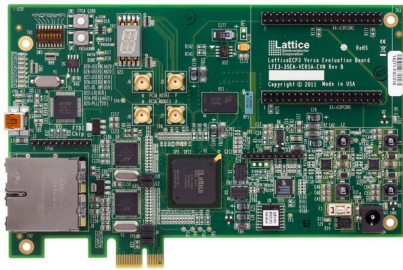

Features

- The LatticeECP3 Versa Evaluation Board:
 - PCI Express 1.1 x1 Edge Connector Interface
 - Two Gigabit Ethernet Ports (RJ45)
 - 4 SMA Connectors for SERDES Access
 - USB Mini for FPGA Programming
 - LatticeECP3 FPGA: LFE3-35EA-FF484
 - 64 Mbit Serial Flash memory
 - 1 Gbit DDR3 Memory
 - 14-segment alpha-numeric display
 - Switches and LEDs for demos
 - SERDES Eye Quality Demo
 - 4 PCI Express Demos
- Gigabit Ethernet MAC Demo using Mico32
- DDR3 Memory Controller Demo
- Available on Windows and Linux platforms
- USB A to USB B (Mini) Cable for FPGA Programming via a PC
- 12V AC Power Adapter and International Plug Adapters
- QuickSTART Guide

Ordering Part Number	Price
LFE3-35EA-VERSA-EVN	\$99*

* This kit is available for a special price of \$99 until December 31, 2011. Standard list price: \$299.

HDR-60 Video Camera Development Kit

A fully production ready High Dynamic Range (HDR) camera, designed to fit into commercially available camera housings. Supports full 1080p resolution at 60 frames per second in streaming mode through the FPGA, without the need for an external frame buffer.



Features

- FPGA-based Image Signal Processing
- Fully Production-Ready HDR Camera Design
- 1080p Capable @ 60 frames per second
 - Supports up to 16 Megapixel Sensors
- Supports up to two sensors simultaneously
- Full 60fps in streaming mode needs no external frame buffer
- Fast Auto Exposure Instantly Adjust to Changing Light
- Greater than 120 dB High Dynamic Range (HDR) Performance
- Direct HDMI/DVI output from FPGA
- Extremely Low-Latency
- Comprehensive Image Processing IP Library
- On-board Broadcom® Broadreach™ PHY Enables IP over Coax
- On-board FTDI Chip provides easy programming via low cost USB cable

Ordering Part Number	Price
LFE3-70EA-HDR60-DKN	\$399

LatticeECP3 PCI Express Development Kit

Develop PCIe-based platforms using a low-cost, low-power SERDES-based FPGA with proprietary and Lattice provided designs.

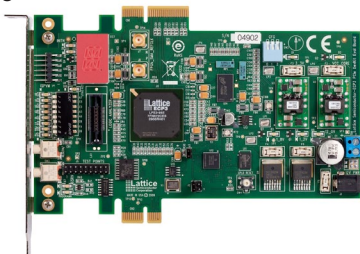

Features

- LatticeECP3 PCI Express x1/x4 Solutions Board
 - PCI Express x1 and x4 edge connector interfaces
 - On-board Boot Flash
 - Both Serial SPI Flash and Parallel Flash via MachXO programming bridge
 - Shows interoperation with a high performance DDR2 memory component
 - Switches, LEDs, displays for demo purposes
 - Input connection for lab-power supply
- Power connections and power sources
- ispVM™ programming support
- On-board and external reference clock sources
- Available on Windows and Linux platforms
- Software and IP with a 60-day license (Windows or Linux)
- Variety of demos
- USB download cable

Ordering Part Number	Price
LFE3-95EA-PCIE-DKN	\$895

LatticeXP2 Brevia2 Development Kit

Easy-to-use, low-cost platform for evaluating and designing with LatticeXP2 FPGAs.

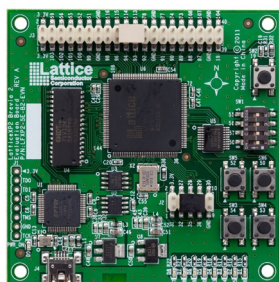

Features

- LatticeXP2 FPGA: LFXP2-5E-6TN144C
- 2 Mbit SPI Flash Memory
- 1 Mbit SRAM
- Programmed via included mini-USB Cable
- 2x20 and 2x5 Expansion Headers
- Push buttons for General Purpose I/O and Reset
- 4-bit DIP Switch for user-defined inputs
- 8 Status LEDs for user-defined outputs

Ordering Part Number	Price
LFXP2-5E-B2-EVN	\$49

iCEblink40 Evaluation Kit

Available
2Q 2012



Features

- Two versions:
 - High Performance: iCE40HX1K-VQ100
 - Low Power: iCE40LP1K-QN84
- Powered by USB input
- 1Mbit SPI PROM (enough for two iCE40HX1K images using WarmBoot)
- Four capacitive-touch buttons (requires FPGA logic)
- Four user LEDs
- Dual PMOD header compatible with Digilent PMOD boards (6x2 header)
- 3.33 MHz oscillator (can be modified to support 33.33 MHz or 333 kHz)
- 1.2V and 3.3V power supplies
- All iCE40HX1K I/O available on headers or 0.1" through-holes

ispMACH 4000ZE Pico Development Kit

Battery-powered, low-cost platform to accelerate the evaluation of ispMACH 4000ZE CPLDs.

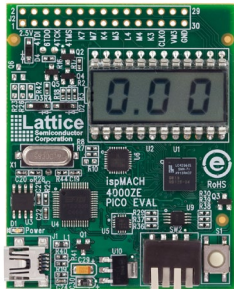

Features

- Pre-programmed Pico Power Demo
- ispMACH 4000ZE device (LC4256ZE-5MN144C)
- Power Manager II device (ispPAC-POWR6AT6-01SN32I)
- LCD panel
- USB mini jack socket for power, JTAG programming, and I²C interface
- 2X15 header landing for off-board expansion provides access to LC4256ZE GPIOs, POWR6AT6 VMON inputs, I²C, and JTAG chain
- Push-button for global reset
- 4-bit DIP switch to user-defined inputs
- 3.3V and 2.5V supply rails
- Current and voltage sensor circuits
- Battery or USB power source
- RoHS-compliant packaging and process
- Marked for CE, China RoHS Environmental-Friendly Use Period (EFUP) and Waste Electrical and Electronic Equipment (WEEE) Directives
- One USB connector cable
- QuickSTART Guide

Ordering Part Number	Price
LC4256ZE-P-EVN	\$69

MachXO2 Pico Development Kit

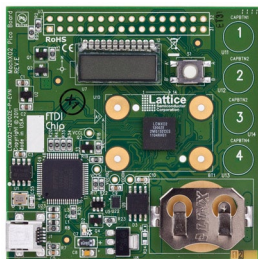

Features

- MachXO2 LCMXO2-1200ZE
- 4-character 16-segment LCD display
- 4 capacitive touch sense buttons
- 1 Mbit SPI Flash
- I²C temperature sensor
- Current and voltage sensor circuits
- Expansion header for JTAG, I²C
- Standard USB cable for device programming and I²C communication
- RS-232/USB & JTAG/USB interface
- RoHS-compliant packaging and process
- Watch battery
- QuickSTART Guide

Ordering Part Number	Price
LCMXO2-1200ZE-P1-EVN	\$49

MachXO2 Control Development Kit

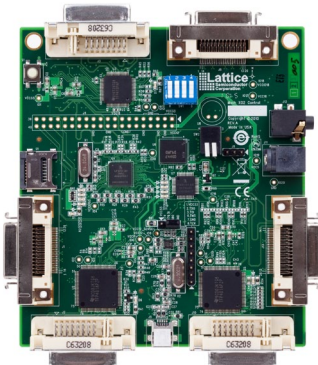

Features

- MachXO2 LCMXO2-1200HC
- Power Manager II ispPAC-POWR1014A
- 128Mbit LPDDR memory, 4Mbit SPI Flash
- Current and voltage sensor circuits
- SD memory card socket
- Microphone
- Audio Amplifier and Delta-Sigma ADC
- Up to two DVI sources and one DVI output.
- Up to two Display Inputs (7:1 LVDS) and one Display Output (7:1 LVDS)
- Audio output channel
- Expansion header for JTAG, SPI, I²C and PLD I/Os.
- LEDs & switches
- Standard USB cable for device programming
- RS-232/USB & JTAG/USB interface
- RoHS-compliant packaging and process
- AC adapter (international plugs)
- QuickSTART Guide

Ordering Part Number	Price
LCMXO2-1200HC-C-EVN	\$189

MachXO Pico Dev. Kit & MachXO Control Dev. Kit

MachXO Mini Development Kit Features

- MachXO PLD: LCMXO2280C-4TN144C
- 2 Mbit SPI Flash memory
- 1 Mbit SRAM
- I²C temperature sensor
- USB mini jack sockets for power, JTAG programming, and RS-232 debugging
- 2X16 header for off-board expansion provides access to top and right side MachXO banks
- Push-buttons for sleep mode and reset
- 4-bit DIP switch to user-defined inputs
- ADC/DAC circuit
- Sleep circuit
- 8 LEDs for user-defined outputs
- RoHS-compliant packaging and process
- Two USB connector cables
- QuickSTART Guide

MachXO Control Development Kit Features

- Preloaded Control SoC Demo
- MachXO LCMXO2280
- Power Manager II ispPAC-POWR1014A
- 2Mbit SPI Flash & 1Mbit SRAM
- I²C temperature sensor
- Current and voltage sensor circuits
- On-board fan
- Interface to 16 x 2 LCD panel*
- SD memory and Compact Flash memory card sockets*
- Audio output channel
- Expansion header for SPI & I²C
- LEDs & switches
- Standard USB cable for device programming and I²C communication
- RS-232/USB & JTAG/USB interface
- 3" x 1" prototyping area
- RoHS-compliant packaging and process
- * LCD panel and SD/Compact Flash memory not included in the development kit

Ordering Part Number	Price
LCMXO2280C-M-EVN	\$89
LCMXO2280C-C-EVN	\$165

Platform Manager Development Kit

A versatile, ready-to-use hardware platform for evaluating and designing with Platform Manager devices.

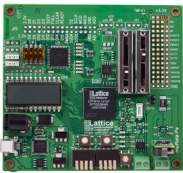

Features

- Preloaded Power Management Demo
- LPTM10-12107, Platform Manager, 208-ball ftBGA package
- 35mm slide pots to emulate supply rail variations
- Pads for user I/O, LED, and switches
- JTAG and I²C interface headers
- USB Cable

- AC adapter with international plugs
- Programmable with ispVM System software
- QuickSTART Guide

Ordering Part Number	Price
LPTM10-12107-DEV-EVN	\$109

Power Manager II Hercules Development Kit

Versatile, ready to use hardware platforms for evaluating and designing with Power Manager II devices. A Standard and Advanced Edition of each kit is available.

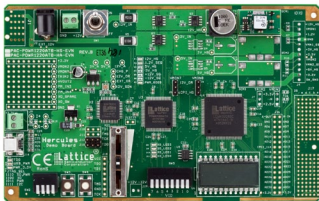

Features

- The Standard Edition Hercules Development Kit features the following:
 - Preloaded Board Digital Management Demo
 - Hercules Standard Edition eval board
 - Power Manager II ispPAC-POWR1220AT8 and MachXO LCMXO2280 PLD
- The Advanced Edition Hercules Development Kit features the following:
 - Preloaded Board Digital Management Demo

- Hercules Advanced Edition evaluation board with CompactPCI headers
- Power Manager II ispPAC-POWR1220AT8 and MachXO LCMXO2280 PLD
- Backplane accessory evaluation board and power supply for live hot-swap
- AC adapter (international plugs)
- USB Connector Cable
- RoHS-compliant packaging and process

Ordering Part Number	Price
PAC-POWR1220AT8-HS-EVN	\$109

ProcessorPM Development Kit

Versatile, ready-to-use hardware platform for evaluating and designing with ProcessorPM power management devices.

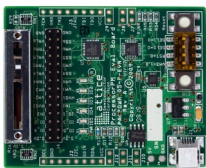

Features

- Pre-configured Processor Support Demo
- ProcessorPM-POWR605
- Power Manager II POWR6AT6
- 3.3V, 2.5V, and 1.8V supply rails
- LEDs
- Slide potentiometer
- 2x14 expansion header
- USB mini jack socket (program/power)
- 2 Push-Buttons

- 4-Bit DIP Switch
- JTAG and I²C Header Landings
- RoHS-compliant packaging and process
- USB connector cable
- QuickSTART Guide

Ordering Part Number	Price
PACPOWR605-P-EVN	\$49

Breakout Board Evaluation Kits

Breakout Board Evaluation Kits for select MachXO2, MachXO, ispMACH 4000ZE, Power Manager II devices offer convenient hardware evaluations by providing easy hand-access to PLD I/Os.



Features:

- Preprogrammed with hardware test program LCMXO2-1200ZE-1TG144C PLD (MachXO2 Breakout Board), LCMXO2280C-FTN256C PLD (MachXO2280 Breakout Board), POWR1014A-02TN48I (POWR1014A Breakout Board), or LC4256ZE-TN144C CPLD (ispMACH 4256ZE Breakout Board)
- LEDs
- Expansion Header Landings

- Prototyping Area
- USB Mini Jack Socket (Program/Power)
- JTAG Header Landing
- RoHS-compliant packaging and process
- USB connector cable

Ordering Part Number	Price
LCMXO2-1200ZE-B-EVN	\$29.99
LCMXO2280-B-EVN	\$29.99
LC4256ZE-B-EVN	\$29.99
POWR1014A-B-EVN	\$29.99

FPGA & CPLD Development Kits and Evaluation Boards

Product	Part Number	PCIe Edge	PCI Edge	Ethernet	SMA	Memory	Prototype Area	Utility LEDs, Switches	Additional Features
LatticeECP3 and ECP2 Boards and Kits									
LatticeECP3 Versa	LFE3-35EA-VERSA-EVN	x1		10/100/1000	SERDES	1G DDR3	Expansion Connectors	✓	
LatticeECP3 AMC Evaluation Platform	LFE3-150EA-AMC-DKN			10/100/1000		DDR2		✓	AMC PCB card edge interface
LatticeECP3 PCIe	LFE3-95EA-PCIE-DKN	x1, x4				DDR2		✓	
LatticeECP2M PCIe	DK-PCIE-ECP2M-011	x1, x4				DDR2		✓	
LatticeECP3 Serial Protocol	LFE3-95EA-SP-EVN	x4		10/100/1000	SERDES, LVDS, PLL	DDR2, DDR3		✓	Serial ATA
LatticeECP3 I/O Protocol	LFE3-150EA-IO-EVN			10/100/1000	SERDES, LVDS, PLL	2x DDR3 DIMM	✓	✓	HMZD Conn., Logic Analyzer Probe Connector.
LatticeECP3 Video Protocol	LFE3-95EA-V-EVN	x4				DDR2		✓	BNCs for SD/HD/3G-SDI, DisplayPort, ChannelLink, CameraLink, DVI
LatticeECP2™ LatticeMico32/DSP	LFE2-50E-D-EV			10/100		DDR SO-DIMM	✓	✓	DAC/ADC, RS-232, SRAM, USB1.0
LatticeECP3 IO Protocol ADC-DAC Interface	LFE3-ADC-DAC-EVN								Connects LatticeECP3 I/O Protocol Board to 3rd party ADC and DAC boards.
MachX02 and X0 Boards and Kits									
MachX02 Pico	LCMX02-1200ZE-P1-EVN					Flash		✓	
MachX02 Control	LCMX02-1200HC-C-EVN					LPDDR, Flash		✓	
MachX0 Mini	LCMX02280C-M-EVN							✓	Mini System-On-Chip design, terminal program interface
MachX0 Control	LCMX02280C-C-EVN								Fan control, power supply mgmt and LCD panel interface
MachX02-1200ZE Breakout Board	LCMX02-1200ZE-B-EVN						✓	✓	
MachX02280 Breakout Board	LCMX02280-B-EVN						✓	✓	
iCE40 Boards and Kits									
iCEblink40 High Performance	ICE40HX1K-BLINK-EVN						✓	✓	
iCEblink40 Low Power	ICE40LP1K-BLINK-EVN						✓	✓	
LatticeXP2 Boards and Kits									
LatticeXP2 Brevia2	LFXP2-5E-B2-EVN					SRAM, Flash		✓	
LatticeXP2 Standard	LFXP2-17E-L-EV						✓	✓	DAC/ADC, RS-232, SRAM, Compact Flash (CF) Connector
LatticeXP2 Advanced	LFXP2-17E-H-EV		64-bit	10/100/1000	LVDS, PLL	DDR2 SO-DIMM	✓	✓	DAC/ADC, RS-232, MDR-26, USB2.0, PS2 I/O, CF Connector
ispMACH 4000ZE Boards and Kits									
ispMACH 4000ZE Pico	LC4256ZE-P-EVN							✓	Battery powered with current metering
ispMACH 4000ZE	LC4064ZE-EVN						✓	✓	
ispMACH 4000ZE	LC4256ZE-EVN						✓	✓	
ispMACH 4256ZE Breakout Board	LC4256ZE-B-EVN						✓	✓	
Video Boards and Kits									
HDR-60 Video Camera	LFE3-70EA-HDR60-DKN			IP Over Coax		DDR2	Expansion Connectors	✓	1080p/60fps HDR video, HDMI
Dual Sensor Interface Board	LCMX02-4000HE-DSIB-EVN								For use only with HDR-60 Video Camera Board. Enables dual-camera / 3D applications.
MN34041 Sensor Nanvesta Headboard	LF-PNV-EVN								Image sensor board for use only with HDR-60 Video Camera Board.
9MT024 Sensor Nanvesta Headboard	LF-9MT024NV-EVN								Image sensor board for use only with HDR-60 Video Camera Board.

Mixed Signal Development Kits and Evaluation Boards

Board	Device	Package	I/O Access	LEDs and Switches	Special Circuits	Included Hardware
Development Kits						
Platform Manager Development Kit	LPTM10-12107	208 ftBGA	USB, PCB test points, header, power terminals	LCD, DIP switches, button and slide potentiometer	Temperature measurement, power supply margin and trim, fault logging, reset distribution, I ² C/SPI interfaces, voltage scaling	USB cable, wall adapter power supply
Power Manager II Hercules Development Kit	ispPAC-POWR1220AT8 MachXO2280	100 TQFP 144 TQFP	USB, PCB test points, header, power terminals	LCD, DIP switches, button and toggle switches, slide potentiometer	12V hot swap and power OR'ing, power supply margin and trim, fault logging, reset distribution, I ² C/SPI interfaces, voltage scaling	USB cable, wall adapter power supply
ProcessorPM Development Kit	ispPAC-POWR605	24 QFN	12V DC wall adapter	Status LEDs, DIP switch	USB interface, voltage measurements	USB cable, wall power supply
Evaluation Boards						
ispClock5312S Evaluation Board	ispClock5312S	48 TQFP	SMA	Status LEDs, DIP switch	Integrated power supply	DB25 parallel programming cable wall adapter power supply (US standard, 300mA)
ispClock5620A Evaluation Board	ispClock5620A	100 TQFP	SMA	Status LEDs, DIP switch		DB25 parallel programming cable wall adapter power supply (US standard, 300mA)
POWR1014A Breakout Board	ispPAC-POWR1014A	48 TQFP	PCB test points	Status LEDs		USB cable

Programming Hardware

Product	Part Number	Description
Download Cable (1.8V to 5V Parallel Port Programming Cable)	HW-DLN-3C	Parallel port programming cable
Download Cable (1.2V to 5V USB Programming Cable)	HW-USBN-2A	USB programming cable
Model 300 Desktop Programmer	pDS4102-PM300	Enables prototype programming of all Lattice JTAG non-volatile programmable logic products (1.8V, 2.5V, 3.3V, and 5V programming voltages).
Desktop Programming Socket Adapters	—	Adapters are specific for the device/package combination required. See the Lattice web site for a complete list of adapters available.

FPGA and CPLD Design Software

		Lattice Diamond 2.0 (Subscription License) Windows/Linux	Lattice Diamond 2.0 (Free License) Windows/Linux	ispLEVER Classic 1.5 Windows	iCEcube2 (Free License) Windows/Linux
FPGA/CPLD Support	LatticeECP3	✓			
	LatticeECP2M/S	✓			
	LatticeECP2S	✓			
	LatticeSC/M	✓			
	MachXO2	✓	✓		
	MachXO	✓	✓		
	LatticeXP2	✓	✓		
	LatticeECP2	✓	✓		
	LatticeECP/EC	✓	✓		
	LatticeXP	✓	✓		
	iCE40				✓
	iCE65				✓
	ispMACH 4000B/C/V/Z/ZE			✓	
	ispMACH 5000VG			✓	
	ispXPGA®			✓	
	ORCA® FPGA			✓	
	ORCA FPSC			✓	
	ispXPLD® 5000MX			✓	
	MACH4A3/4A5			✓	
	ispLSI® 2000/5000			✓	
ispGDx2™ and ispGDx®			✓		
ispGAL™ and GAL®			✓		
Software Features	Design Exploration	✓	✓		✓
	Project Management	✓	✓	✓	✓
	VHDL & Verilog Support	✓	✓	✓	✓
	EDIF Support	✓	✓	✓	✓
	Schematic Support	✓	✓	✓	✓
	ABEL			✓	
	Synopsys® Synplify Pro™ for Lattice-Synthesis	✓	✓	✓	✓
	Lattice Synthesis Engine (LSE)	MachXO2/MachXO Only	MachXO2/MachXO Only		
	IP and Module Configuration	✓	✓	Module Only	
	Power Estimation & Calculation	✓	✓		✓
	Timing Analysis	✓	✓	✓	✓
	Integrated HDL Analysis	✓	✓		✓
	Floorplanning	✓	✓	✓	✓
	EPIC Device Editor	✓	✓	ORCA FPGA Only	
	On-Chip Debug	✓	✓	ispXPGA Only	
TCL Scripting Dictionaries	✓	✓			
Operating Systems	Aldec® Active-HDL Lattice Edition Simulation	Windows Only	Windows Only	Windows Only	✓
	Windows 7/XP/Vista (32-bit and 64-bit)	✓	✓	✓	✓
	Linux (Red Hat Enterprise v4, v5, v6; 32-bit and 64-bit)	✓	✓		✓
Licensing & Updates	License Terms	One Year Subscription	One Year – Renewable	One Year – Renewable	One Year – Renewable
	Node-Locked License	✓	✓	✓	✓
	Floating License	✓			✓

PAC-Designer – Mixed-Signal Design Software

Device Support	Design Entry	Simulation	Programming Mgmt.	License	Operating System
Platform Manager	Schematic, LogiBuilder, Design Utilities	Waveform Simulation Active-HDL	PAC-Designer and ispVM System	Single User, Floating	Windows 7/Vista/XP/2000
ProcessorPM					
Power Manager II					
Power Manager					
ispClock5600A					
ispClock5300S					
ispClock5600V					

Corporate Headquarters

Lattice Semiconductor Corporation
5555 Northeast Moore Court
Hillsboro, Oregon 97124-6421 USA
Telephone: +1-503-268-8000
Facsimile: +1-503-268-8347
Web: <http://www.latticesemi.com>

Software Licensing

Email: lic_admn@latticesemi.com
Web: <http://www.latticesemi.com/licensing/index.cfm>

Technical Support

USA & Canada: 1-800-LATTICE (528-8423)
For other locations: +1-503-268-8001
PLD Technical and Software: techsupport@latticesemi.com
Mixed Signal: ispPACs@latticesemi.com

Additionally, customers can receive technical support for Lattice's Programmable Logic Products from our Asia based applications group, by contacting Lattice Asia applications during the hours of 8:30 a.m. to 5:30 p.m. Beijing Time (CST) +0800 UTC (Chinese and English language only).
Asia: +86-21-52989090
techsupport-asia@latticesemi.com

Copyright © 2012 Lattice Semiconductor Corporation. All brand names or product names are trademarks or registered trademarks of their respective holders. Lattice Semiconductor Corporation, L Lattice Semiconductor Corporation (logo), L (stylized), L (design), Lattice (design), Lattice Diamond, LSC, E²CMOS, FlashBAK, flexiFLASH, flexiMAC, flexiPCS, FreedomChip, GAL, GDX, Generic Array Logic, HDL Explorer, iCE40, iCEblink, iCEcube2, IPexpress, ISP, ispATE, ispClock, ispDOWNLOAD, ispGAL, ispGDS, ispGDX, ispGDXV, ispGDX2, ispGENERATOR, ispJTAG, ispLeverCORE, ispLSI, ispMACH, ispPAC, ispTURBO, ispVIRTUAL MACHINE, ispVM, ispXP, ispXPGA, ispXPLD, LatticeCORE, LatticeECP3, LatticeECP2, LatticeECP2M, LatticeECP, LatticeECP-DSP, LatticeMico, LatticeMico8, LatticeMico32, LatticeSC, LatticeSCM, LatticeXP, LatticeXP2, MACH, MachXO, MachXO2, MACO, ORCA, PAC, PAC-Designer, PAL, Performance Analyst, Platform Manager, ProcessorPM, PURESPEED, Reveal, Silicon Forest, Speedlocked, Speed Locking, sysCLOCK, sysCONFIG, sysDSP, sysHSI, sysI/O, sysMEM, The Simple Machine for Complex Design, TransFR, UltraMOS, and specific product designations are either registered trademarks or trademarks of Lattice Semiconductor Corporation or its subsidiaries in the United States and/or other countries. ISP is a service mark of Lattice Semiconductor Corporation.



August 2012 • Order #: I0211H



Компания «ЭлектроПласт» предлагает заключение долгосрочных отношений при поставках импортных электронных компонентов на взаимовыгодных условиях!

Наши преимущества:

- Оперативные поставки широкого спектра электронных компонентов отечественного и импортного производства напрямую от производителей и с крупнейших мировых складов;
- Поставка более 17-ти миллионов наименований электронных компонентов;
- Поставка сложных, дефицитных, либо снятых с производства позиций;
- Оперативные сроки поставки под заказ (от 5 рабочих дней);
- Экспресс доставка в любую точку России;
- Техническая поддержка проекта, помощь в подборе аналогов, поставка прототипов;
- Система менеджмента качества сертифицирована по Международному стандарту ISO 9001;
- Лицензия ФСБ на осуществление работ с использованием сведений, составляющих государственную тайну;
- Поставка специализированных компонентов (Xilinx, Altera, Analog Devices, Intersil, Interpoint, Microsemi, Aeroflex, Peregrine, Syfer, Eurofarad, Texas Instrument, Miteq, Cobham, E2V, MA-COM, Hittite, Mini-Circuits, General Dynamics и др.);

Помимо этого, одним из направлений компании «ЭлектроПласт» является направление «Источники питания». Мы предлагаем Вам помощь Конструкторского отдела:

- Подбор оптимального решения, техническое обоснование при выборе компонента;
- Подбор аналогов;
- Консультации по применению компонента;
- Поставка образцов и прототипов;
- Техническая поддержка проекта;
- Защита от снятия компонента с производства.



Как с нами связаться

Телефон: 8 (812) 309 58 32 (многоканальный)

Факс: 8 (812) 320-02-42

Электронная почта: org@eplast1.ru

Адрес: 198099, г. Санкт-Петербург, ул. Калинина, дом 2, корпус 4, литера А.