

EasyPIM™ Modul mit schnellem Trench/Feldstopp IGBT4 und Emitter Controlled 4 Diode und NTC  
EasyPIM™ module with fast Trench/Fieldstop IGBT4 and Emitter Controlled 4 diode and NTC

**Vorläufige Daten / Preliminary Data**

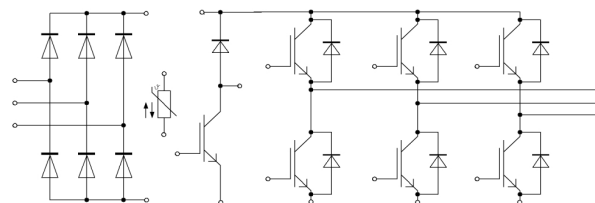
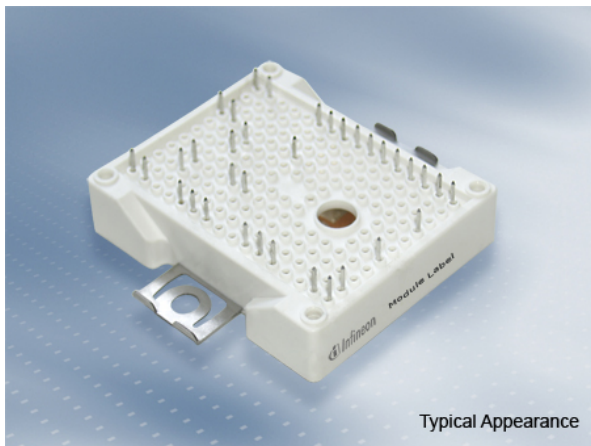

$V_{CES} = 1200V$   
 $I_{C\ nom} = 35A / I_{CRM} = 70A$

**Typische Anwendungen**

- Hilfsumrichter
- Klimaanlage
- Motorantriebe

**Typical Applications**

- Auxiliary Inverters
- Air Conditioning
- Motor Drives

**Elektrische Eigenschaften**

- Niedrige Schaltverluste
- Trench IGBT 4
- $V_{CESat}$  mit positivem Temperaturkoeffizienten
- Niedriges  $V_{CESat}$

**Electrical Features**

- Low Switching Losses
- Trench IGBT 4
- $V_{CESat}$  with positive Temperature Coefficient
- Low  $V_{CESat}$

**Mechanische Eigenschaften**

- $Al_2O_3$  Substrat mit kleinem thermischen Widerstand
- Kompaktes Design
- Lötverbindungstechnik
- Robuste Montage durch integrierte Befestigungsklammern

**Mechanical Features**

- $Al_2O_3$  Substrate with Low Thermal Resistance
- Compact design
- Solder Contact Technology
- Rugged mounting due to integrated mounting clamps

**Module Label Code**

Barcode Code 128



DMX - Code



**Content of the Code**

| Content of the Code        | Digit   |
|----------------------------|---------|
| Module Serial Number       | 1 - 5   |
| Module Material Number     | 6 - 11  |
| Production Order Number    | 12 - 19 |
| Datecode (Production Year) | 20 - 21 |
| Datecode (Production Week) | 22 - 23 |

|                 |                                 |                      |
|-----------------|---------------------------------|----------------------|
| prepared by: DK | date of publication: 2013-10-03 |                      |
| approved by: MB | revision: 2.2                   | UL approved (E83335) |



**Vorläufige Daten  
Preliminary Data**

**IGBT, Wechselrichter / IGBT, Inverter  
Höchstzulässige Werte / Maximum Rated Values**

|  |   |                            |          |        |
|--|---|----------------------------|----------|--------|
| Kollektor-Emitter-Sperrspannung<br>Collector-emitter voltage             | $T_{vj} = 25^{\circ}\text{C}$   | $V_{CES}$                  | 1200     | V      |
| Kollektor-Dauergleichstrom<br>Continuous DC collector current            | $T_C = 100^{\circ}\text{C}, T_{vj\text{max}} = 175^{\circ}\text{C}$<br>$T_C = 25^{\circ}\text{C}, T_{vj\text{max}} = 175^{\circ}\text{C}$ | $I_{C\text{nom}}$<br>$I_C$ | 35<br>54 | A<br>A |
| Periodischer Kollektor-Spitzenstrom<br>Repetitive peak collector current | $t_P = 1\text{ ms}$   | $I_{CRM}$                  | 70       | A      |
| Gesamt-Verlustleistung<br>Total power dissipation                        | $T_C = 25^{\circ}\text{C}, T_{vj\text{max}} = 175$  | $P_{tot}$                  | 215      | W      |
| Gate-Emitter-Spitzenspannung<br>Gate-emitter peak voltage                |   | $V_{GES}$                  | +/-20    | V      |

**Charakteristische Werte / Characteristic Values**

|   |   |   | min.               | typ.                    | max. |             |   |
|---|---|---|--------------------|-------------------------|------|-------------|---|
| Kollektor-Emitter-Sättigungsspannung<br>Collector-emitter saturation voltage    | $I_C = 35\text{ A}, V_{GE} = 15\text{ V}$<br>$I_C = 35\text{ A}, V_{GE} = 15\text{ V}$<br>$I_C = 35\text{ A}, V_{GE} = 15\text{ V}$   | $T_{vj} = 25^{\circ}\text{C}$<br>$T_{vj} = 125^{\circ}\text{C}$<br>$T_{vj} = 150^{\circ}\text{C}$ | $V_{CE\text{sat}}$ | 1,85<br>2,15<br>2,25    | 2,25 | V<br>V<br>V |   |
| Gate-Schwellenspannung<br>Gate threshold voltage                                | $I_C = 1,20\text{ mA}, V_{CE} = V_{GE}, T_{vj} = 25^{\circ}\text{C}$  |   | $V_{GEth}$         | 5,2                     | 5,8  | 6,4         | V   |
| Gateladung<br>Gate charge   | $V_{GE} = -15\text{ V} \dots +15\text{ V}$  |   | $Q_G$              | 0,27                    |      |             | $\mu\text{C}$                                   |
| Interner Gatewiderstand<br>Internal gate resistor                               | $T_{vj} = 25^{\circ}\text{C}$   |   | $R_{Gint}$         | 0,0                     |      |             | $\Omega$  |
| Eingangskapazität<br>Input capacitance  | $f = 1\text{ MHz}, T_{vj} = 25^{\circ}\text{C}, V_{CE} = 25\text{ V}, V_{GE} = 0\text{ V}$  |   | $C_{ies}$          | 2,00                    |      |             | nF  |
| Rückwirkungskapazität<br>Reverse transfer capacitance                           | $f = 1\text{ MHz}, T_{vj} = 25^{\circ}\text{C}, V_{CE} = 25\text{ V}, V_{GE} = 0\text{ V}$  |   | $C_{res}$          | 0,07                    |      |             | nF  |
| Kollektor-Emitter-Reststrom<br>Collector-emitter cut-off current                | $V_{CE} = 1200\text{ V}, V_{GE} = 0\text{ V}, T_{vj} = 25^{\circ}\text{C}$  |   | $I_{CES}$          |                         |      | 1,0         | mA  |
| Gate-Emitter-Reststrom<br>Gate-emitter leakage current                          | $V_{CE} = 0\text{ V}, V_{GE} = 20\text{ V}, T_{vj} = 25^{\circ}\text{C}$  |   | $I_{GES}$          |                         |      | 400         | nA  |
| Einschaltverzögerungszeit, induktive Last<br>Turn-on delay time, inductive load | $I_C = 35\text{ A}, V_{CE} = 600\text{ V}$<br>$V_{GE} = \pm 15\text{ V}$<br>$R_{Gon} = 12\ \Omega$  | $T_{vj} = 25^{\circ}\text{C}$<br>$T_{vj} = 125^{\circ}\text{C}$<br>$T_{vj} = 150^{\circ}\text{C}$ | $t_{don}$          | 0,025<br>0,025<br>0,025 |      |             | $\mu\text{s}$<br>$\mu\text{s}$<br>$\mu\text{s}$ |
| Anstiegszeit, induktive Last<br>Rise time, inductive load                       | $I_C = 35\text{ A}, V_{CE} = 600\text{ V}$<br>$V_{GE} = \pm 15\text{ V}$<br>$R_{Gon} = 12\ \Omega$  | $T_{vj} = 25^{\circ}\text{C}$<br>$T_{vj} = 125^{\circ}\text{C}$<br>$T_{vj} = 150^{\circ}\text{C}$ | $t_r$              | 0,013<br>0,016<br>0,018 |      |             | $\mu\text{s}$<br>$\mu\text{s}$<br>$\mu\text{s}$ |
| Abschaltverzögerungszeit, induktive Last<br>Turn-off delay time, inductive load | $I_C = 35\text{ A}, V_{CE} = 600\text{ V}$<br>$V_{GE} = \pm 15\text{ V}$<br>$R_{Goff} = 12\ \Omega$   | $T_{vj} = 25^{\circ}\text{C}$<br>$T_{vj} = 125^{\circ}\text{C}$<br>$T_{vj} = 150^{\circ}\text{C}$ | $t_{doff}$         | 0,24<br>0,295<br>0,31   |      |             | $\mu\text{s}$<br>$\mu\text{s}$<br>$\mu\text{s}$ |
| Fallzeit, induktive Last<br>Fall time, inductive load                           | $I_C = 35\text{ A}, V_{CE} = 600\text{ V}$<br>$V_{GE} = \pm 15\text{ V}$<br>$R_{Goff} = 12\ \Omega$   | $T_{vj} = 25^{\circ}\text{C}$<br>$T_{vj} = 125^{\circ}\text{C}$<br>$T_{vj} = 150^{\circ}\text{C}$ | $t_f$              | 0,115<br>0,17<br>0,20   |      |             | $\mu\text{s}$<br>$\mu\text{s}$<br>$\mu\text{s}$ |
| Einschaltverlustenergie pro Puls<br>Turn-on energy loss per pulse               | $I_C = 35\text{ A}, V_{CE} = 600\text{ V}, L_S = 35\text{ nH}$<br>$V_{GE} = \pm 15\text{ V}, di/dt = 2500\text{ A}/\mu\text{s} (T_{vj} = 150^{\circ}\text{C})$<br>$R_{Gon} = 12\ \Omega$  | $T_{vj} = 25^{\circ}\text{C}$<br>$T_{vj} = 125^{\circ}\text{C}$<br>$T_{vj} = 150^{\circ}\text{C}$ | $E_{on}$           | 1,90<br>2,90<br>3,15    |      |             | mJ<br>mJ<br>mJ                                  |
| Abschaltverlustenergie pro Puls<br>Turn-off energy loss per pulse               | $I_C = 35\text{ A}, V_{CE} = 600\text{ V}, L_S = 35\text{ nH}$<br>$V_{GE} = \pm 15\text{ V}, du/dt = 3600\text{ V}/\mu\text{s} (T_{vj} = 150^{\circ}\text{C})$<br>$R_{Goff} = 12\ \Omega$ | $T_{vj} = 25^{\circ}\text{C}$<br>$T_{vj} = 125^{\circ}\text{C}$<br>$T_{vj} = 150^{\circ}\text{C}$ | $E_{off}$          | 2,00<br>2,90<br>3,20    |      |             | mJ<br>mJ<br>mJ                                  |
| Kurzschlussverhalten<br>SC data   | $V_{GE} \leq 15\text{ V}, V_{CC} = 900\text{ V}$<br>$V_{CEmax} = V_{CES} - L_{SCE} \cdot di/dt$ $t_P \leq 10\ \mu\text{s}, T_{vj} = 150^{\circ}\text{C}$                                  |   | $I_{SC}$           | 130                     |      |             | A   |
| Wärmewiderstand, Chip bis Gehäuse<br>Thermal resistance, junction to case       | pro IGBT / per IGBT   |   | $R_{thJC}$         | 0,60                    | 0,70 |             | K/W   |
| Wärmewiderstand, Gehäuse bis Kühlkörper<br>Thermal resistance, case to heatsink | pro IGBT / per IGBT<br>$\lambda_{Paste} = 1\text{ W}/(\text{m}\cdot\text{K})$ / $\lambda_{grease} = 1\text{ W}/(\text{m}\cdot\text{K})$   |   | $R_{thCH}$         | 0,60                    |      |             | K/W   |
| Temperatur im Schaltbetrieb<br>Temperature under switching conditions           |   |   | $T_{vj\text{op}}$  | -40                     | 150  |             | $^{\circ}\text{C}$                              |

|                 |                                 |
|-----------------|---------------------------------|
| prepared by: DK | date of publication: 2013-10-03 |
| approved by: MB | revision: 2.2                   |



**Vorläufige Daten  
Preliminary Data**

**Diode, Wechselrichter / Diode, Inverter**

**Höchstzulässige Werte / Maximum Rated Values**

|   |  |           |      |                      |
|---|--|-----------|------|----------------------|
| Periodische Spitzensperrspannung<br>Repetitive peak reverse voltage | $T_{vj} = 25^{\circ}\text{C}$  | $V_{RRM}$ | 1200 | V                    |
| Dauergleichstrom<br>Continuous DC forward current                   |  | $I_F$     | 35   | A                    |
| Periodischer Spitzenstrom<br>Repetitive peak forward current        | $t_P = 1\text{ ms}$  | $I_{FRM}$ | 70   | A                    |
| Grenzlastintegral<br>$I^2t$ - value                                 | $V_R = 0\text{ V}, t_P = 10\text{ ms}, T_{vj} = 125^{\circ}\text{C}$ | $I^2t$    | 240  | $\text{A}^2\text{s}$ |
|   | $V_R = 0\text{ V}, t_P = 10\text{ ms}, T_{vj} = 150^{\circ}\text{C}$ |           | 220  | $\text{A}^2\text{s}$ |

**Charakteristische Werte / Characteristic Values**

|   |   |                                | min. | typ. | max. |                    |
|---|---|--------------------------------|------|------|------|--------------------|
| Durchlassspannung<br>Forward voltage  | $I_F = 35\text{ A}, V_{GE} = 0\text{ V}$  | $T_{vj} = 25^{\circ}\text{C}$  |      | 1,65 | 2,15 | V                  |
|   | $I_F = 35\text{ A}, V_{GE} = 0\text{ V}$  | $T_{vj} = 125^{\circ}\text{C}$ |      | 1,65 |      | V                  |
|   | $I_F = 35\text{ A}, V_{GE} = 0\text{ V}$  | $T_{vj} = 150^{\circ}\text{C}$ |      | 1,65 |      | V                  |
| Rückstromspitze<br>Peak reverse recovery current                                | $I_F = 35\text{ A}, -di_F/dt = 2500\text{ A}/\mu\text{s} (T_{vj}=150^{\circ}\text{C})$<br>$V_R = 600\text{ V}$<br>$V_{GE} = -15\text{ V}$ | $T_{vj} = 25^{\circ}\text{C}$  |      | 81,0 |      | A                  |
|   |   | $T_{vj} = 125^{\circ}\text{C}$ |      | 85,0 |      | A                  |
|   |   | $T_{vj} = 150^{\circ}\text{C}$ |      | 88,0 |      | A                  |
| Sperrverzögerungsladung<br>Recovered charge                                     | $I_F = 35\text{ A}, -di_F/dt = 2500\text{ A}/\mu\text{s} (T_{vj}=150^{\circ}\text{C})$<br>$V_R = 600\text{ V}$<br>$V_{GE} = -15\text{ V}$ | $T_{vj} = 25^{\circ}\text{C}$  |      | 3,95 |      | $\mu\text{C}$      |
|   |   | $T_{vj} = 125^{\circ}\text{C}$ |      | 6,80 |      | $\mu\text{C}$      |
|   |   | $T_{vj} = 150^{\circ}\text{C}$ |      | 7,50 |      | $\mu\text{C}$      |
| Abschaltenergie pro Puls<br>Reverse recovery energy                             | $I_F = 35\text{ A}, -di_F/dt = 2500\text{ A}/\mu\text{s} (T_{vj}=150^{\circ}\text{C})$<br>$V_R = 600\text{ V}$<br>$V_{GE} = -15\text{ V}$ | $T_{vj} = 25^{\circ}\text{C}$  |      | 1,50 |      | mJ                 |
|   |   | $T_{vj} = 125^{\circ}\text{C}$ |      | 2,70 |      | mJ                 |
|   |   | $T_{vj} = 150^{\circ}\text{C}$ |      | 2,95 |      | mJ                 |
| Wärmewiderstand, Chip bis Gehäuse<br>Thermal resistance, junction to case       | pro Diode / per diode   | $R_{thJC}$                     |      | 0,80 | 0,90 | K/W                |
| Wärmewiderstand, Gehäuse bis Kühlkörper<br>Thermal resistance, case to heatsink | pro Diode / per diode<br>$\lambda_{Paste} = 1\text{ W}/(\text{m}\cdot\text{K}) / \lambda_{grease} = 1\text{ W}/(\text{m}\cdot\text{K})$   | $R_{thCH}$                     |      | 0,75 |      | K/W                |
| Temperatur im Schaltbetrieb<br>Temperature under switching conditions           |   | $T_{vj op}$                    | -40  |      | 150  | $^{\circ}\text{C}$ |

**Diode, Gleichrichter / Diode, Rectifier**

**Höchstzulässige Werte / Maximum Rated Values**

|   |   |             |      |                      |
|---|---|-------------|------|----------------------|
| Periodische Spitzensperrspannung<br>Repetitive peak reverse voltage                 | $T_{vj} = 25^{\circ}\text{C}$   | $V_{RRM}$   | 1600 | V                    |
| Durchlassstrom Grenzeffektivwert pro Chip<br>Maximum RMS forward current per chip   | $T_C = 100^{\circ}\text{C}$   | $I_{FRMSM}$ | 60   | A                    |
| Gleichrichter Ausgang Grenzeffektivstrom<br>Maximum RMS current at rectifier output | $T_C = 100^{\circ}\text{C}$   | $I_{RMSM}$  | 60   | A                    |
| Stoßstrom Grenzwert<br>Surge forward current  | $t_p = 10\text{ ms}, T_{vj} = 25^{\circ}\text{C}$<br>$t_p = 10\text{ ms}, T_{vj} = 150^{\circ}\text{C}$ | $I_{FSM}$   | 450  | A                    |
|   |   |             | 370  | A                    |
| Grenzlastintegral<br>$I^2t$ - value   | $t_p = 10\text{ ms}, T_{vj} = 25^{\circ}\text{C}$<br>$t_p = 10\text{ ms}, T_{vj} = 150^{\circ}\text{C}$ | $I^2t$      | 1000 | $\text{A}^2\text{s}$ |
|   |   |             | 685  | $\text{A}^2\text{s}$ |

**Charakteristische Werte / Characteristic Values**

|   |   |             | min. | typ. | max. |                    |
|---|---|-------------|------|------|------|--------------------|
| Durchlassspannung<br>Forward voltage  | $T_{vj} = 150^{\circ}\text{C}, I_F = 35\text{ A}$   | $V_F$       |      | 0,95 |      | V                  |
| Sperrstrom<br>Reverse current   | $T_{vj} = 150^{\circ}\text{C}, V_R = 1600\text{ V}$   | $I_R$       |      | 1,00 |      | mA                 |
| Wärmewiderstand, Chip bis Gehäuse<br>Thermal resistance, junction to case       | pro Diode / per diode   | $R_{thJC}$  |      | 1,05 | 1,15 | K/W                |
| Wärmewiderstand, Gehäuse bis Kühlkörper<br>Thermal resistance, case to heatsink | pro Diode / per diode<br>$\lambda_{Paste} = 1\text{ W}/(\text{m}\cdot\text{K}) / \lambda_{grease} = 1\text{ W}/(\text{m}\cdot\text{K})$ | $R_{thCH}$  |      | 0,95 |      | K/W                |
| Temperatur im Schaltbetrieb<br>Temperature under switching conditions           |   | $T_{vj op}$ |      |      |      | $^{\circ}\text{C}$ |

|                 |                                 |
|-----------------|---------------------------------|
| prepared by: DK | date of publication: 2013-10-03 |
| approved by: MB | revision: 2.2                   |



**Vorläufige Daten  
Preliminary Data**

**IGBT, Brems-Chopper / IGBT, Brake-Chopper  
Höchstzulässige Werte / Maximum Rated Values**

|  |   |                             |          |        |
|--|---|-----------------------------|----------|--------|
| Kollektor-Emitter-Sperrspannung<br>Collector-emitter voltage             | $T_{vj} = 25^{\circ}\text{C}$   | $V_{CES}$                   | 1200     | V      |
| Kollektor-Dauergleichstrom<br>Continuous DC collector current            | $T_C = 100^{\circ}\text{C}, T_{vj\text{ max}} = 175^{\circ}\text{C}$<br>$T_C = 25^{\circ}\text{C}, T_{vj\text{ max}} = 175^{\circ}\text{C}$ | $I_{C\text{ nom}}$<br>$I_C$ | 35<br>54 | A<br>A |
| Periodischer Kollektor-Spitzenstrom<br>Repetitive peak collector current | $t_P = 1\text{ ms}$   | $I_{CRM}$                   | 70       | A      |
| Gesamt-Verlustleistung<br>Total power dissipation                        | $T_C = 25^{\circ}\text{C}, T_{vj\text{ max}} = 175$   | $P_{tot}$                   | 215      | W      |
| Gate-Emitter-Spitzenspannung<br>Gate-emitter peak voltage                |   | $V_{GES}$                   | +/-20    | V      |

**Charakteristische Werte / Characteristic Values**

|   |  |   | min.                | typ.                    | max. |   |
|---|--|---|---------------------|-------------------------|------|---|
| Kollektor-Emitter-Sättigungsspannung<br>Collector-emitter saturation voltage    | $I_C = 35\text{ A}, V_{GE} = 15\text{ V}$<br>$I_C = 35\text{ A}, V_{GE} = 15\text{ V}$<br>$I_C = 35\text{ A}, V_{GE} = 15\text{ V}$                      | $T_{vj} = 25^{\circ}\text{C}$<br>$T_{vj} = 125^{\circ}\text{C}$<br>$T_{vj} = 150^{\circ}\text{C}$ | $V_{CE\text{ sat}}$ | 1,85<br>2,15<br>2,25    | 2,25 | V<br>V<br>V                                     |
| Gate-Schwellenspannung<br>Gate threshold voltage                                | $I_C = 1,20\text{ mA}, V_{CE} = V_{GE}, T_{vj} = 25^{\circ}\text{C}$   |   | $V_{GEth}$          | 5,2<br>5,8              | 6,4  | V   |
| Gateladung<br>Gate charge   | $V_{GE} = -15\text{ V} \dots +15\text{ V}$   |   | $Q_G$               | 0,27                    |      | $\mu\text{C}$                                   |
| Interner Gatewiderstand<br>Internal gate resistor                               | $T_{vj} = 25^{\circ}\text{C}$  |   | $R_{Gint}$          | 0,0                     |      | $\Omega$  |
| Eingangskapazität<br>Input capacitance  | $f = 1\text{ MHz}, T_{vj} = 25^{\circ}\text{C}, V_{CE} = 25\text{ V}, V_{GE} = 0\text{ V}$   |   | $C_{ies}$           | 2,00                    |      | nF  |
| Rückwirkungskapazität<br>Reverse transfer capacitance                           | $f = 1\text{ MHz}, T_{vj} = 25^{\circ}\text{C}, V_{CE} = 25\text{ V}, V_{GE} = 0\text{ V}$   |   | $C_{res}$           | 0,07                    |      | nF  |
| Kollektor-Emitter-Reststrom<br>Collector-emitter cut-off current                | $V_{CE} = 1200\text{ V}, V_{GE} = 0\text{ V}, T_{vj} = 25^{\circ}\text{C}$   |   | $I_{CES}$           |                         | 1,0  | mA  |
| Gate-Emitter-Reststrom<br>Gate-emitter leakage current                          | $V_{CE} = 0\text{ V}, V_{GE} = 20\text{ V}, T_{vj} = 25^{\circ}\text{C}$   |   | $I_{GES}$           |                         | 400  | nA  |
| Einschaltverzögerungszeit, induktive Last<br>Turn-on delay time, inductive load | $I_C = 35\text{ A}, V_{CE} = 600\text{ V}$<br>$V_{GE} = \pm 15\text{ V}$<br>$R_{Gon} = 47\ \Omega$   | $T_{vj} = 25^{\circ}\text{C}$<br>$T_{vj} = 125^{\circ}\text{C}$<br>$T_{vj} = 150^{\circ}\text{C}$ | $t_{don}$           | 0,07<br>0,07<br>0,07    |      | $\mu\text{s}$<br>$\mu\text{s}$<br>$\mu\text{s}$ |
| Anstiegszeit, induktive Last<br>Rise time, inductive load                       | $I_C = 35\text{ A}, V_{CE} = 600\text{ V}$<br>$V_{GE} = \pm 15\text{ V}$<br>$R_{Gon} = 47\ \Omega$   | $T_{vj} = 25^{\circ}\text{C}$<br>$T_{vj} = 125^{\circ}\text{C}$<br>$T_{vj} = 150^{\circ}\text{C}$ | $t_r$               | 0,045<br>0,05<br>0,057  |      | $\mu\text{s}$<br>$\mu\text{s}$<br>$\mu\text{s}$ |
| Abschaltverzögerungszeit, induktive Last<br>Turn-off delay time, inductive load | $I_C = 35\text{ A}, V_{CE} = 600\text{ V}$<br>$V_{GE} = \pm 15\text{ V}$<br>$R_{Goff} = 47\ \Omega$  | $T_{vj} = 25^{\circ}\text{C}$<br>$T_{vj} = 125^{\circ}\text{C}$<br>$T_{vj} = 150^{\circ}\text{C}$ | $t_{doff}$          | 0,28<br>0,44<br>0,45    |      | $\mu\text{s}$<br>$\mu\text{s}$<br>$\mu\text{s}$ |
| Fallzeit, induktive Last<br>Fall time, inductive load                           | $I_C = 35\text{ A}, V_{CE} = 600\text{ V}$<br>$V_{GE} = \pm 15\text{ V}$<br>$R_{Goff} = 47\ \Omega$  | $T_{vj} = 25^{\circ}\text{C}$<br>$T_{vj} = 125^{\circ}\text{C}$<br>$T_{vj} = 150^{\circ}\text{C}$ | $t_f$               | 0,115<br>0,175<br>0,205 |      | $\mu\text{s}$<br>$\mu\text{s}$<br>$\mu\text{s}$ |
| Einschaltverlustenergie pro Puls<br>Turn-on energy loss per pulse               | $I_C = 35\text{ A}, V_{CE} = 600\text{ V}, L_S = 35\text{ nH}$<br>$V_{GE} = \pm 15\text{ V}$<br>$R_{Gon} = 47\ \Omega$                                   | $T_{vj} = 25^{\circ}\text{C}$<br>$T_{vj} = 125^{\circ}\text{C}$<br>$T_{vj} = 150^{\circ}\text{C}$ | $E_{on}$            | 5,00<br>6,50<br>7,00    |      | mJ<br>mJ<br>mJ                                  |
| Abschaltverlustenergie pro Puls<br>Turn-off energy loss per pulse               | $I_C = 35\text{ A}, V_{CE} = 600\text{ V}, L_S = 35\text{ nH}$<br>$V_{GE} = \pm 15\text{ V}$<br>$R_{Goff} = 47\ \Omega$                                  | $T_{vj} = 25^{\circ}\text{C}$<br>$T_{vj} = 125^{\circ}\text{C}$<br>$T_{vj} = 150^{\circ}\text{C}$ | $E_{off}$           | 2,10<br>3,05<br>3,35    |      | mJ<br>mJ<br>mJ                                  |
| Kurzschlußverhalten<br>SC data  | $V_{GE} \leq 15\text{ V}, V_{CC} = 900\text{ V}$<br>$V_{CEmax} = V_{CES} - L_{SCE} \cdot di/dt$ $t_P \leq 10\ \mu\text{s}, T_{vj} = 150^{\circ}\text{C}$ |   | $I_{SC}$            | 130                     |      | A   |
| Wärmewiderstand, Chip bis Gehäuse<br>Thermal resistance, junction to case       | pro IGBT / per IGBT  |   | $R_{thJC}$          | 0,60                    | 0,70 | K/W   |
| Wärmewiderstand, Gehäuse bis Kühlkörper<br>Thermal resistance, case to heatsink | pro IGBT / per IGBT<br>$\lambda_{Paste} = 1\text{ W}/(\text{m}\cdot\text{K})$ / $\lambda_{grease} = 1\text{ W}/(\text{m}\cdot\text{K})$                  |   | $R_{thCH}$          | 0,60                    |      | K/W   |
| Temperatur im Schaltbetrieb<br>Temperature under switching conditions           |  |   | $T_{vj\text{ op}}$  | -40                     | 150  | $^{\circ}\text{C}$                              |

|                 |                                 |
|-----------------|---------------------------------|
| prepared by: DK | date of publication: 2013-10-03 |
| approved by: MB | revision: 2.2                   |



**Vorläufige Daten  
Preliminary Data**

**Diode, Brems-Chopper / Diode, Brake-Chopper  
Höchstzulässige Werte / Maximum Rated Values**

|   |  |           |              |  |
|---|--|-----------|--------------|--|
| Periodische Spitzensperrspannung<br>Repetitive peak reverse voltage | $T_{vj} = 25^{\circ}\text{C}$  | $V_{RRM}$ | 1200         | V  |
| Dauergleichstrom<br>Continuous DC forward current                   |  | $I_F$     | 10           | A  |
| Periodischer Spitzenstrom<br>Repetitive peak forward current        | $t_P = 1\text{ ms}$  | $I_{FRM}$ | 20           | A  |
| Grenzlastintegral<br>$I^2t$ - value                                 | $V_R = 0\text{ V}, t_P = 10\text{ ms}, T_{vj} = 125^{\circ}\text{C}$<br>$V_R = 0\text{ V}, t_P = 10\text{ ms}, T_{vj} = 150^{\circ}\text{C}$ | $I^2t$    | 16,0<br>14,0 | $\text{A}^2\text{s}$<br>$\text{A}^2\text{s}$ |

**Charakteristische Werte / Characteristic Values**

|   |   |   | min.               | typ.                 | max. |   |
|---|---|---|--------------------|----------------------|------|---|
| Durchlassspannung<br>Forward voltage  | $I_F = 10\text{ A}, V_{GE} = 0\text{ V}$<br>$I_F = 10\text{ A}, V_{GE} = 0\text{ V}$<br>$I_F = 10\text{ A}, V_{GE} = 0\text{ V}$        | $T_{vj} = 25^{\circ}\text{C}$<br>$T_{vj} = 125^{\circ}\text{C}$<br>$T_{vj} = 150^{\circ}\text{C}$ | $V_F$              | 1,75<br>1,75<br>1,75 | 2,25 | V<br>V<br>V                                     |
| Rückstromspitze<br>Peak reverse recovery current                                | $I_F = 10\text{ A}, -di_F/dt = 500\text{ A}/\mu\text{s} (T_{vj}=150^{\circ}\text{C})$<br>$V_R = 600\text{ V}$                           | $T_{vj} = 25^{\circ}\text{C}$<br>$T_{vj} = 125^{\circ}\text{C}$<br>$T_{vj} = 150^{\circ}\text{C}$ | $I_{RM}$           | 12,0<br>10,0<br>8,00 |      | A<br>A<br>A                                     |
| Sperrverzögerungsladung<br>Recovered charge                                     | $I_F = 10\text{ A}, -di_F/dt = 500\text{ A}/\mu\text{s} (T_{vj}=150^{\circ}\text{C})$<br>$V_R = 600\text{ V}$                           | $T_{vj} = 25^{\circ}\text{C}$<br>$T_{vj} = 125^{\circ}\text{C}$<br>$T_{vj} = 150^{\circ}\text{C}$ | $Q_r$              | 0,90<br>1,70<br>1,90 |      | $\mu\text{C}$<br>$\mu\text{C}$<br>$\mu\text{C}$ |
| Abschaltenergie pro Puls<br>Reverse recovery energy                             | $I_F = 10\text{ A}, -di_F/dt = 500\text{ A}/\mu\text{s} (T_{vj}=150^{\circ}\text{C})$<br>$V_R = 600\text{ V}$                           | $T_{vj} = 25^{\circ}\text{C}$<br>$T_{vj} = 125^{\circ}\text{C}$<br>$T_{vj} = 150^{\circ}\text{C}$ | $E_{rec}$          | 0,24<br>0,52<br>0,59 |      | mJ<br>mJ<br>mJ                                  |
| Wärmewiderstand, Chip bis Gehäuse<br>Thermal resistance, junction to case       | pro Diode / per diode   |   | $R_{thJC}$         | 1,75                 | 1,95 | K/W   |
| Wärmewiderstand, Gehäuse bis Kühlkörper<br>Thermal resistance, case to heatsink | pro Diode / per diode<br>$\lambda_{Paste} = 1\text{ W}/(\text{m}\cdot\text{K}) / \lambda_{grease} = 1\text{ W}/(\text{m}\cdot\text{K})$ |   | $R_{thCH}$         | 1,30                 |      | K/W   |
| Temperatur im Schaltbetrieb<br>Temperature under switching conditions           |   |   | $T_{vj\text{ op}}$ | -40                  | 150  | $^{\circ}\text{C}$                              |

**NTC-Widerstand / NTC-Thermistor**

**Charakteristische Werte / Characteristic Values**

|  |   |  | min.         | typ. | max. |                  |
|--|---|--|--------------|------|------|------------------|
| Nennwiderstand<br>Rated resistance       | $T_C = 25^{\circ}\text{C}$                                    |  | $R_{25}$     | 5,00 |      | $\text{k}\Omega$ |
| Abweichung von R100<br>Deviation of R100 | $T_C = 100^{\circ}\text{C}, R_{100} = 493\ \Omega$            |  | $\Delta R/R$ | -5   | 5    | %                |
| Verlustleistung<br>Power dissipation     | $T_C = 25^{\circ}\text{C}$                                    |  | $P_{25}$     |      | 20,0 | mW               |
| B-Wert<br>B-value                        | $R_2 = R_{25} \exp [B_{25/50}(1/T_2 - 1/(298,15\text{ K}))]$  |  | $B_{25/50}$  | 3375 |      | K                |
| B-Wert<br>B-value                        | $R_2 = R_{25} \exp [B_{25/80}(1/T_2 - 1/(298,15\text{ K}))]$  |  | $B_{25/80}$  | 3411 |      | K                |
| B-Wert<br>B-value                        | $R_2 = R_{25} \exp [B_{25/100}(1/T_2 - 1/(298,15\text{ K}))]$ |  | $B_{25/100}$ | 3433 |      | K                |

Angaben gemäß gültiger Application Note.  
Specification according to the valid application note.

|                 |                                 |
|-----------------|---------------------------------|
| prepared by: DK | date of publication: 2013-10-03 |
| approved by: MB | revision: 2.2                   |



**Vorläufige Daten  
Preliminary Data**

**Modul / Module**

|   |   |  |                                |              |        |
|---|---|--|--------------------------------|--------------|--------|
| Isolations-Prüfspannung<br>Isolation test voltage   | RMS, f = 50 Hz, t = 1 min.  | V <sub>ISOL</sub>                            | 2,5                            |              | kV     |
| Innere Isolation<br>Internal isolation  | Basisisolation (Schutzklasse 1, EN61140)<br>basic insulation (class 1, IEC 61140)       |  | Al <sub>2</sub> O <sub>3</sub> |              |        |
| Kriechstrecke<br>Creepage distance  | Kontakt - Kühlkörper / terminal to heatsink<br>Kontakt - Kontakt / terminal to terminal |  | 11,5<br>6,3                    |              | mm     |
| Luftstrecke<br>Clearance  | Kontakt - Kühlkörper / terminal to heatsink<br>Kontakt - Kontakt / terminal to terminal |  | 10,0<br>5,0                    |              | mm     |
| Vergleichszahl der Kriechwegbildung<br>Comperative tracking index                         |   | CTI  | > 200                          |              |        |
|   |   |  | min.                           | typ.         | max.   |
| Modulstreuinduktivität<br>Stray inductance module   |   | L <sub>sCE</sub>                             |                                | 30           | nH     |
| Modulleitungswiderstand, Anschlüsse -<br>Chip<br>Module lead resistance, terminals - chip | T <sub>c</sub> = 25°C, pro Schalter / per switch  | R <sub>CC'+EE'</sub><br>R <sub>AA'+CC'</sub> |                                | 5,00<br>6,00 | mΩ     |
| Lagertemperatur<br>Storage temperature  |   | T <sub>stg</sub>                             | -40                            |              | 125 °C |
| Anpresskraft für mech. Bef. pro Feder<br>mounting force per clamp                         |   | F  | 40                             | -            | 80 N   |
| Gewicht<br>Weight   |   | G  |                                | 39           | g      |

Der Strom im Dauerbetrieb ist auf 30A effektiv pro Anschlusspin begrenzt.  
The current under continuous operation is limited to 30A rms per connector pin.

|                 |                                 |
|-----------------|---------------------------------|
| prepared by: DK | date of publication: 2013-10-03 |
| approved by: MB | revision: 2.2                   |

**Vorläufige Daten**  
**Preliminary Data**

**Ausgangskennlinie IGBT, Wechselrichter (typisch)**  
**output characteristic IGBT, Inverter (typical)**

$I_C = f(V_{CE})$   
 $V_{GE} = 15\text{ V}$

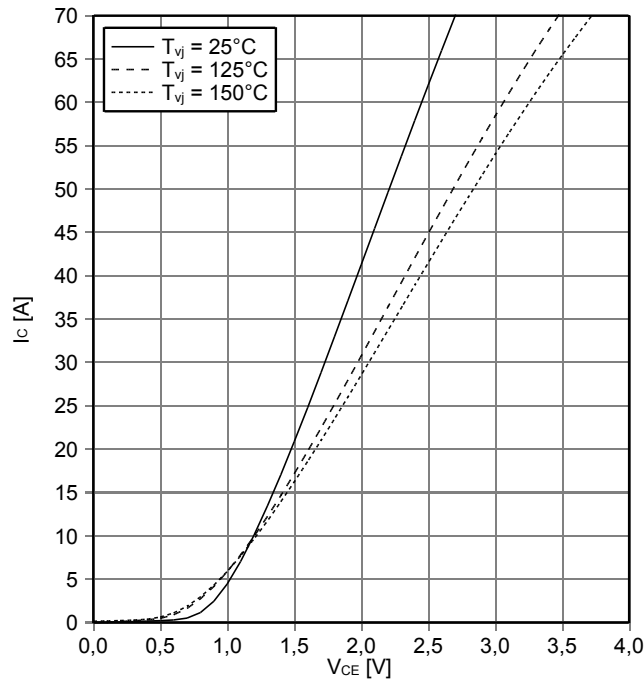

**Ausgangskennlinienfeld IGBT, Wechselrichter (typisch)**  
**output characteristic IGBT, Inverter (typical)**

$I_C = f(V_{CE})$   
 $T_{vj} = 150^\circ\text{C}$

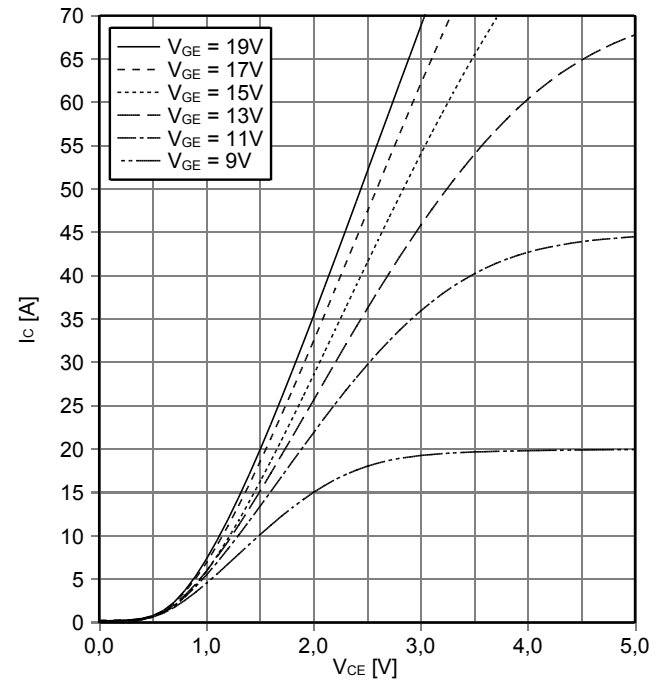

**Übertragungscharakteristik IGBT, Wechselrichter (typisch)**  
**transfer characteristic IGBT, Inverter (typical)**

$I_C = f(V_{GE})$   
 $V_{CE} = 20\text{ V}$

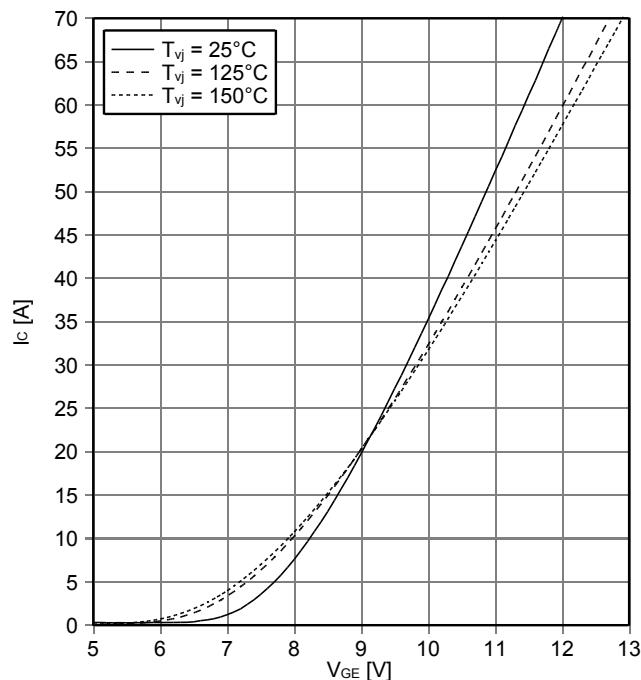

**Schaltverluste IGBT, Wechselrichter (typisch)**  
**switching losses IGBT, Inverter (typical)**

$E_{on} = f(I_C), E_{off} = f(I_C)$   
 $V_{GE} = \pm 15\text{ V}, R_{Gon} = 12\ \Omega, R_{Goff} = 12\ \Omega, V_{CE} = 600\text{ V}$

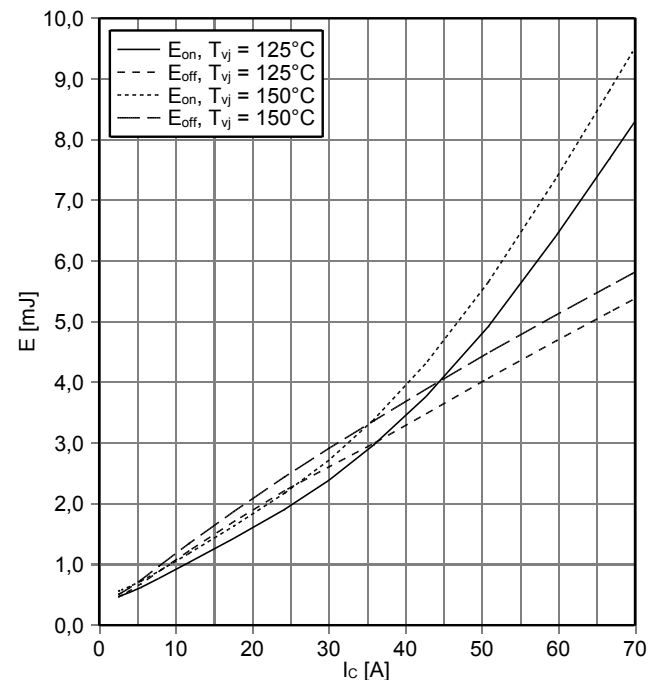

|                 |                                 |
|-----------------|---------------------------------|
| prepared by: DK | date of publication: 2013-10-03 |
| approved by: MB | revision: 2.2                   |



**Vorläufige Daten  
Preliminary Data**

**Schaltverluste IGBT, Wechselrichter (typisch)  
switching losses IGBT, Inverter (typical)**

$E_{on} = f(R_G), E_{off} = f(R_G)$   
 $V_{GE} = \pm 15 V, I_C = 35 A, V_{CE} = 600 V$

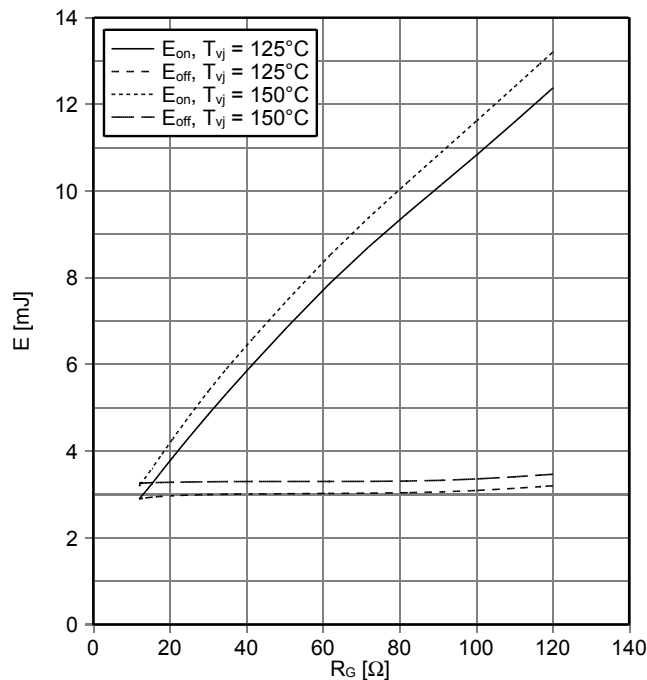

**Transienter Wärmewiderstand IGBT, Wechselrichter  
transient thermal impedance IGBT, Inverter**

$Z_{thJH} = f(t)$

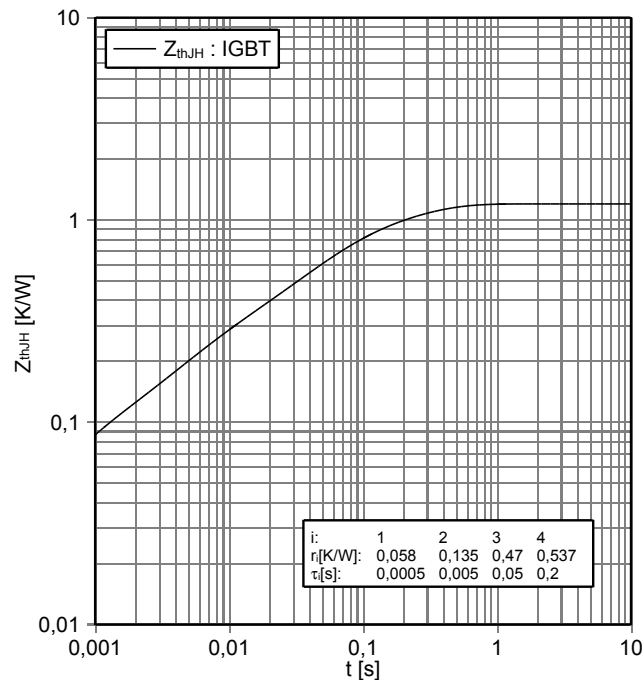

**Sicherer Rückwärts-Arbeitsbereich IGBT, Wechselrichter  
(RBSOA)**

**reverse bias safe operating area IGBT, Inverter (RBSOA)**

$I_C = f(V_{CE})$   
 $V_{GE} = \pm 15 V, R_{Goff} = 12 \Omega, T_{vj} = 150^\circ C$

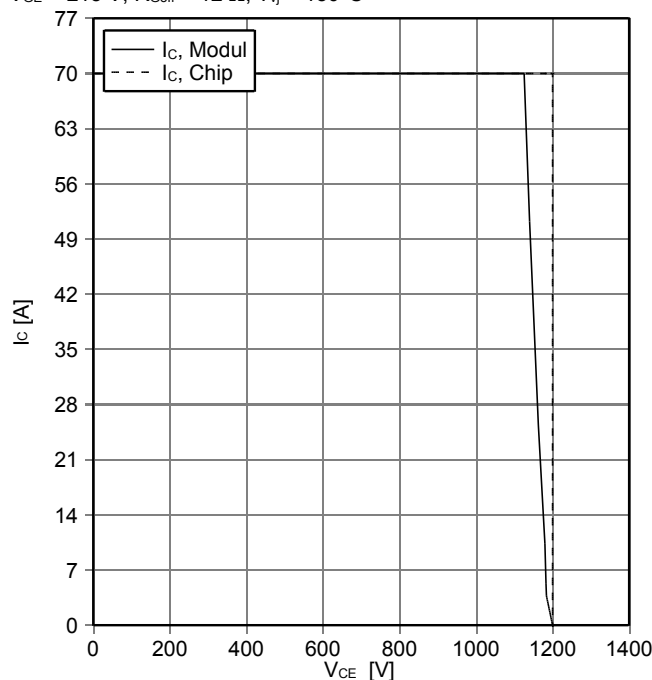

**Durchlasskennlinie der Diode, Wechselrichter (typisch)  
forward characteristic of Diode, Inverter (typical)**

$I_F = f(V_F)$

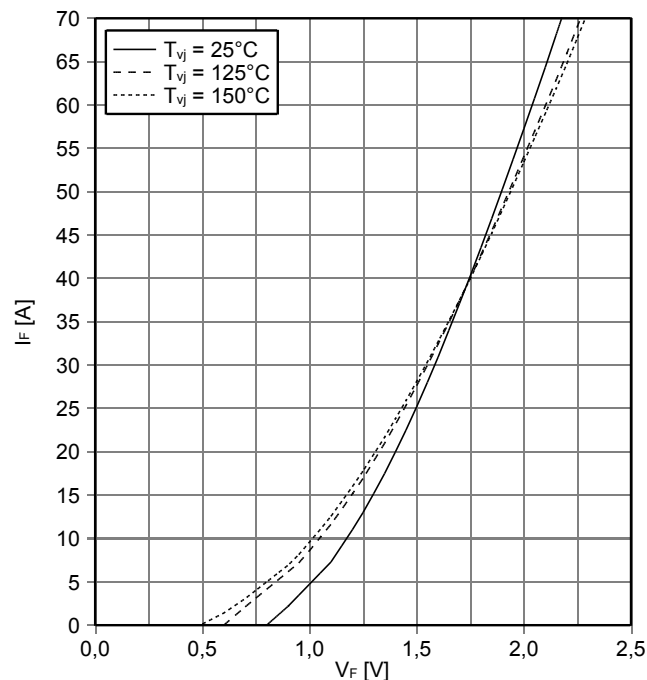

|                 |                                 |
|-----------------|---------------------------------|
| prepared by: DK | date of publication: 2013-10-03 |
| approved by: MB | revision: 2.2                   |





## Vorläufige Daten Preliminary Data

### Schaltverluste Diode, Wechselrichter (typisch) switching losses Diode, Inverter (typical)

$E_{rec} = f(I_F)$   
 $R_{Gon} = 12 \Omega, V_{CE} = 600 V$

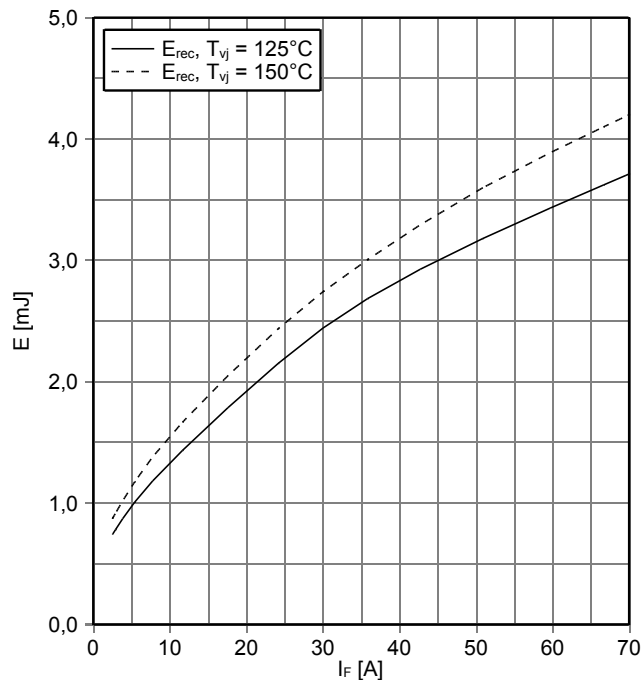

### Schaltverluste Diode, Wechselrichter (typisch) switching losses Diode, Inverter (typical)

$E_{rec} = f(R_G)$   
 $I_F = 35 A, V_{CE} = 600 V$

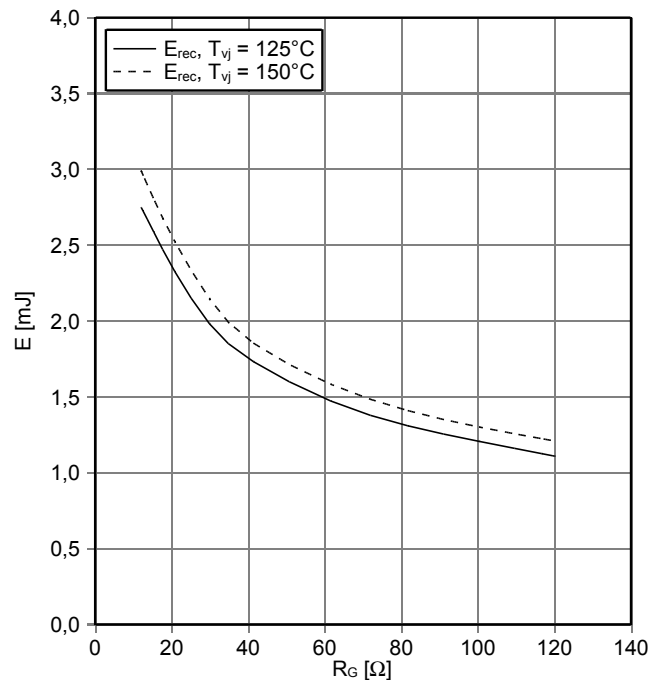

### Transienter Wärmewiderstand Diode, Wechselrichter transient thermal impedance Diode, Inverter

$Z_{thJH} = f(t)$

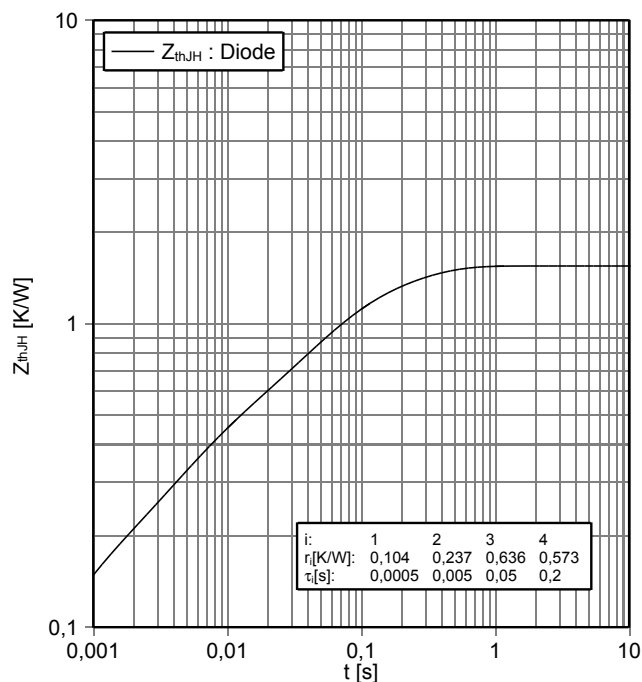

### Durchlasskennlinie der Diode, Gleichrichter (typisch) forward characteristic of Diode, Rectifier (typical)

$I_F = f(V_F)$

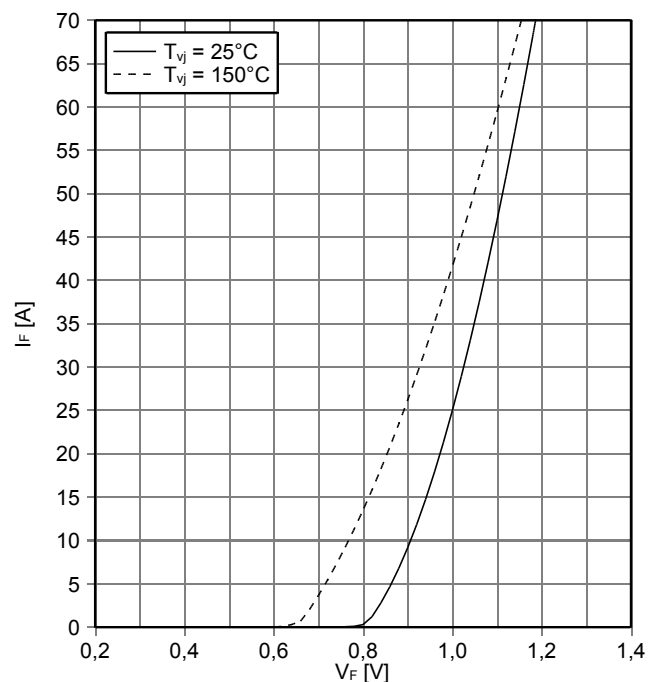

|                 |                                 |
|-----------------|---------------------------------|
| prepared by: DK | date of publication: 2013-10-03 |
| approved by: MB | revision: 2.2                   |

**Vorläufige Daten  
Preliminary Data**

**Ausgangskennlinie IGBT, Brems-Chopper (typisch)**  
**output characteristic IGBT, Brake-Chopper (typical)**

$I_C = f(V_{CE})$   
 $V_{GE} = 15\text{ V}$

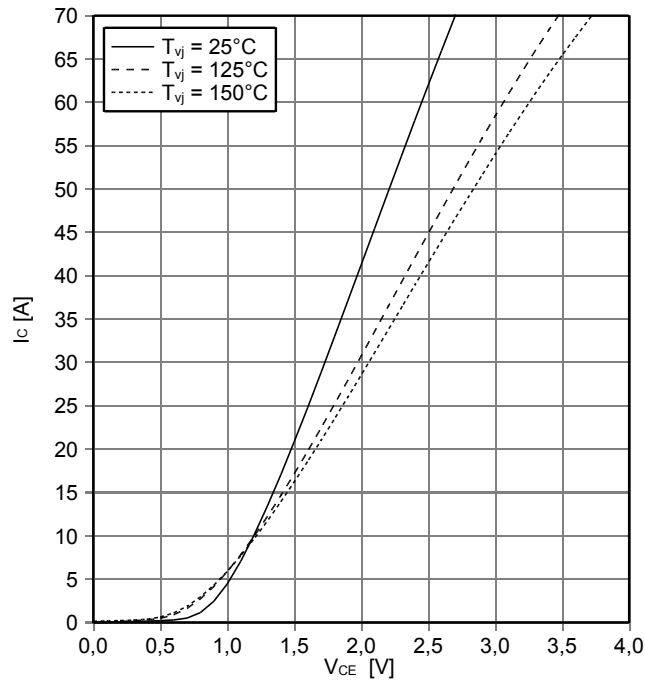

**Durchlasskennlinie der Diode, Brems-Chopper (typisch)**  
**forward characteristic of Diode, Brake-Chopper (typical)**

$I_F = f(V_F)$

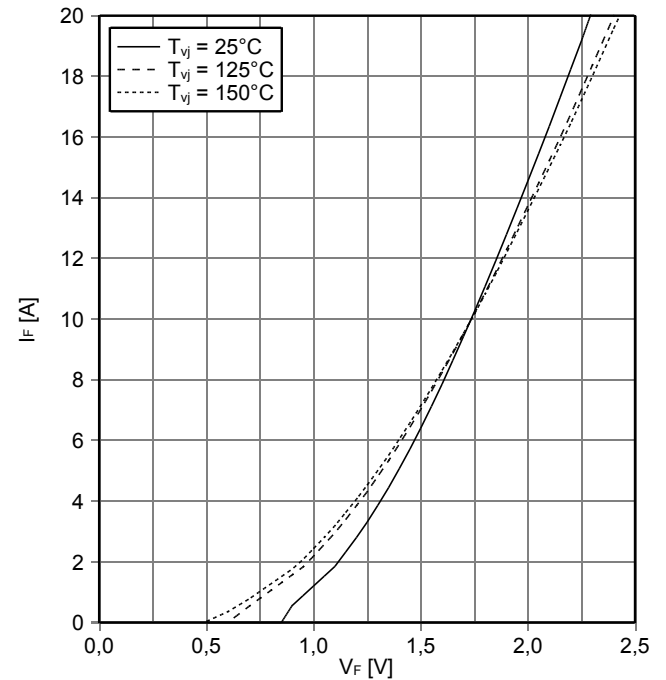

**NTC-Widerstand-Temperaturkennlinie (typisch)**  
**NTC-Thermistor-temperature characteristic (typical)**

$R = f(T)$



|                 |                                 |
|-----------------|---------------------------------|
| prepared by: DK | date of publication: 2013-10-03 |
| approved by: MB | revision: 2.2                   |

**Vorläufige Daten**  
**Preliminary Data**

### Schaltplan / circuit\_diagram\_headline

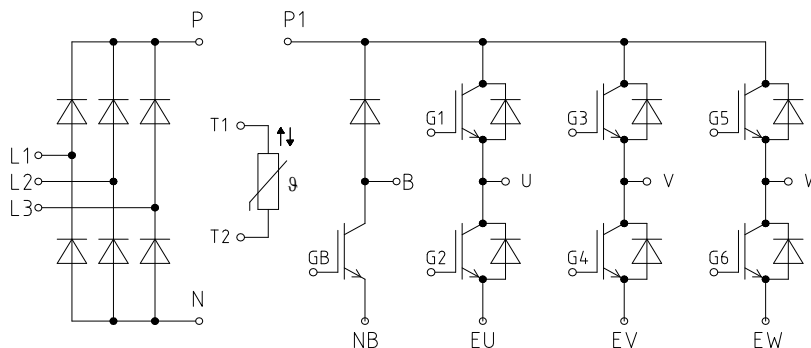

### Gehäuseabmessungen / package outlines

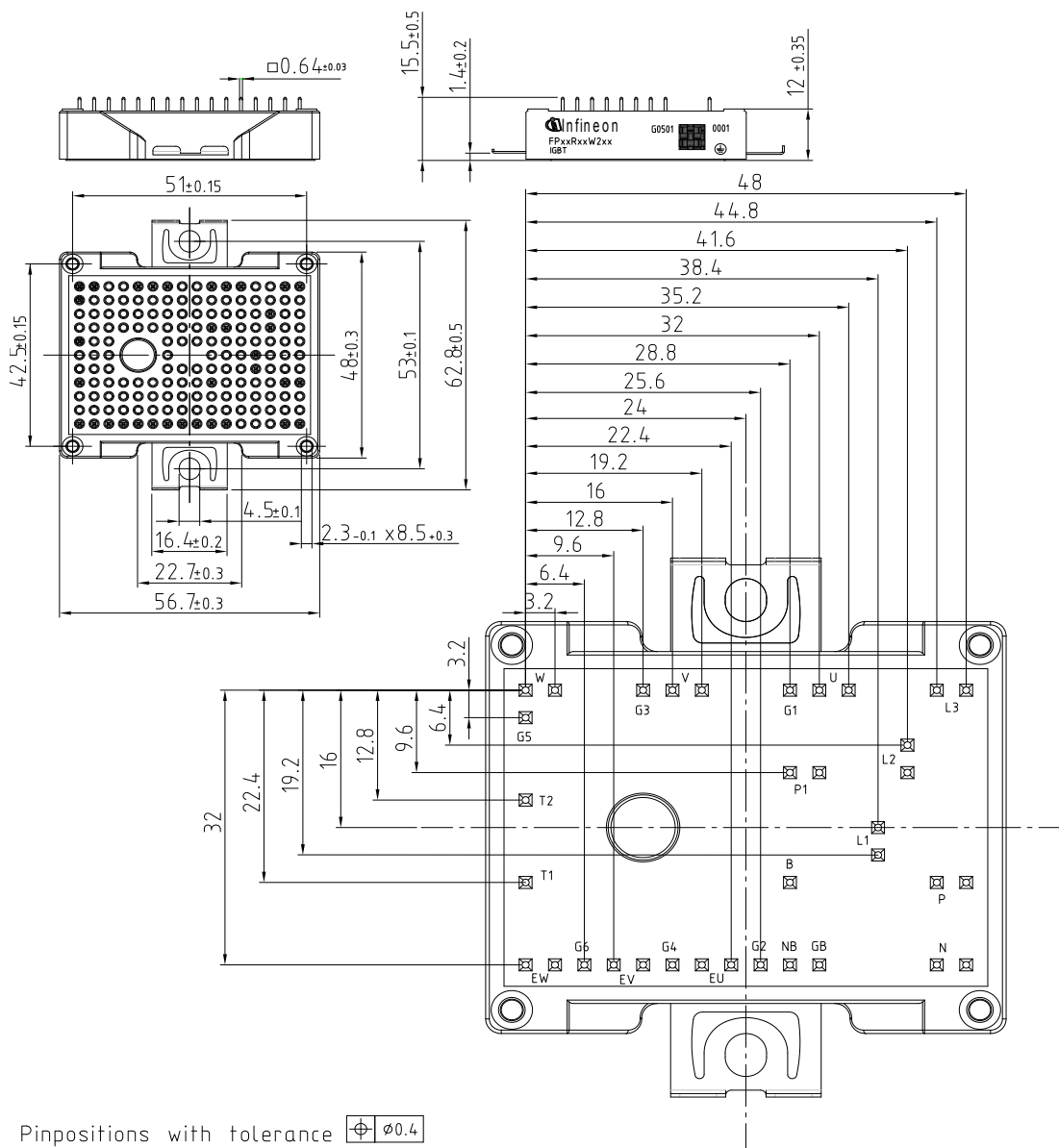

|                 |                                 |
|-----------------|---------------------------------|
| prepared by: DK | date of publication: 2013-10-03 |
| approved by: MB | revision: 2.2                   |



**Vorläufige Daten  
Preliminary Data**

**Nutzungsbedingungen**

Die in diesem Produktdatenblatt enthaltenen Daten sind ausschließlich für technisch geschultes Fachpersonal bestimmt. Die Beurteilung der Eignung dieses Produktes für Ihre Anwendung sowie die Beurteilung der Vollständigkeit der bereitgestellten Produktdaten für diese Anwendung obliegt Ihnen bzw. Ihren technischen Abteilungen.

In diesem Produktdatenblatt werden diejenigen Merkmale beschrieben, für die wir eine liefervertragliche Gewährleistung übernehmen. Eine solche Gewährleistung richtet sich ausschließlich nach Maßgabe der im jeweiligen Liefervertrag enthaltenen Bestimmungen. Garantien jeglicher Art werden für das Produkt und dessen Eigenschaften keinesfalls übernommen. Die Angaben in den gültigen Anwendungs- und Montagehinweisen des Moduls sind zu beachten.

Sollten Sie von uns Produktinformationen benötigen, die über den Inhalt dieses Produktdatenblatts hinausgehen und insbesondere eine spezifische Verwendung und den Einsatz dieses Produktes betreffen, setzen Sie sich bitte mit dem für Sie zuständigen Vertriebsbüro in Verbindung (siehe [www.infineon.com](http://www.infineon.com), Vertrieb&Kontakt). Für Interessenten halten wir Application Notes bereit.

Aufgrund der technischen Anforderungen könnte unser Produkt gesundheitsgefährdende Substanzen enthalten. Bei Rückfragen zu den in diesem Produkt jeweils enthaltenen Substanzen setzen Sie sich bitte ebenfalls mit dem für Sie zuständigen Vertriebsbüro in Verbindung.

Sollten Sie beabsichtigen, das Produkt in Anwendungen der Luftfahrt, in gesundheits- oder lebensgefährdenden oder lebenserhaltenden Anwendungsbereichen einzusetzen, bitten wir um Mitteilung. Wir weisen darauf hin, dass wir für diese Fälle

- die gemeinsame Durchführung eines Risiko- und Qualitätsassessments;
- den Abschluss von speziellen Qualitätssicherungsvereinbarungen;
- die gemeinsame Einführung von Maßnahmen zu einer laufenden Produktbeobachtung dringend empfehlen und gegebenenfalls die Belieferung von der Umsetzung solcher Maßnahmen abhängig machen.

Soweit erforderlich, bitten wir Sie, entsprechende Hinweise an Ihre Kunden zu geben.

Inhaltliche Änderungen dieses Produktdatenblatts bleiben vorbehalten.

**Terms & Conditions of usage**

The data contained in this product data sheet is exclusively intended for technically trained staff. You and your technical departments will have to evaluate the suitability of the product for the intended application and the completeness of the product data with respect to such application.

This product data sheet is describing the characteristics of this product for which a warranty is granted. Any such warranty is granted exclusively pursuant the terms and conditions of the supply agreement. There will be no guarantee of any kind for the product and its characteristics. The information in the valid application- and assembly notes of the module must be considered.

Should you require product information in excess of the data given in this product data sheet or which concerns the specific application of our product, please contact the sales office, which is responsible for you ( see [www.infineon.com](http://www.infineon.com) ). For those that are specifically interested we may provide application notes.

Due to technical requirements our product may contain dangerous substances. For information on the types in question please contact the sales office, which is responsible for you.

Should you intend to use the Product in aviation applications, in health or live endangering or life support applications, please notify. Please note, that for any such applications we urgently recommend

- to perform joint Risk and Quality Assessments;
- the conclusion of Quality Agreements;
- to establish joint measures of an ongoing product survey, and that we may make delivery depended on the realization of any such measures.

If and to the extent necessary, please forward equivalent notices to your customers.

Changes of this product data sheet are reserved.

|                 |                                 |
|-----------------|---------------------------------|
| prepared by: DK | date of publication: 2013-10-03 |
| approved by: MB | revision: 2.2                   |



Компания «ЭлектроПласт» предлагает заключение долгосрочных отношений при поставках импортных электронных компонентов на взаимовыгодных условиях!

Наши преимущества:

- Оперативные поставки широкого спектра электронных компонентов отечественного и импортного производства напрямую от производителей и с крупнейших мировых складов;
- Поставка более 17-ти миллионов наименований электронных компонентов;
- Поставка сложных, дефицитных, либо снятых с производства позиций;
- Оперативные сроки поставки под заказ (от 5 рабочих дней);
- Экспресс доставка в любую точку России;
- Техническая поддержка проекта, помощь в подборе аналогов, поставка прототипов;
- Система менеджмента качества сертифицирована по Международному стандарту ISO 9001;
- Лицензия ФСБ на осуществление работ с использованием сведений, составляющих государственную тайну;
- Поставка специализированных компонентов (Xilinx, Altera, Analog Devices, Intersil, Interpoint, Microsemi, Aeroflex, Peregrine, Syfer, Eurofarad, Texas Instrument, Miteq, Cobham, E2V, MA-COM, Hittite, Mini-Circuits, General Dynamics и др.);

Помимо этого, одним из направлений компании «ЭлектроПласт» является направление «Источники питания». Мы предлагаем Вам помощь Конструкторского отдела:

- Подбор оптимального решения, техническое обоснование при выборе компонента;
- Подбор аналогов;
- Консультации по применению компонента;
- Поставка образцов и прототипов;
- Техническая поддержка проекта;
- Защита от снятия компонента с производства.



#### Как с нами связаться

**Телефон:** 8 (812) 309 58 32 (многоканальный)

**Факс:** 8 (812) 320-02-42

**Электронная почта:** [org@eplast1.ru](mailto:org@eplast1.ru)

**Адрес:** 198099, г. Санкт-Петербург, ул. Калинина, дом 2, корпус 4, литера А.