



## **SMT inductors**

SIMID series, SIMID 0805-F

**Series/Type:**            **B82498F**

**Date:**                    September 2019

### SMD

**Size 0805 (EIA) and/or 2012 (IEC)**

**Rated inductance 2.7 ... 6800 nH**

**Rated current 80 ... 1000 mA**

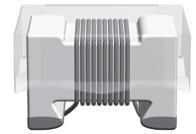

#### **Construction**

- Cubic coil with ceramic or ferrite core
- Epoxy-molded flat top for vacuum pickup
- Winding ends welded to terminals

#### **Features**

- High resonance frequency
- Narrow inductance tolerance
- Suitable for lead-free reflow soldering
- RoHS-compatible

#### **Applications**

Resonant circuits, impedance matching for

- Antenna amplifiers
- Multimedia
- Wireless communication systems

#### **Terminals**

- Base material Al<sub>2</sub>O<sub>3</sub> ceramic and ferrite
- Thick-film coating of Ag/Pd/Pt

#### **Marking**

- No marking on component
- Minimum data on reel:  
Manufacturer, ordering code, L value, quantity, date of packing

#### **Delivery mode and packing unit**

- 8-mm blister tape, wound on 180-mm reel
- Packing unit: 3000 pcs./reel

**SMD**

**Dimensional drawing and layout recommendation**

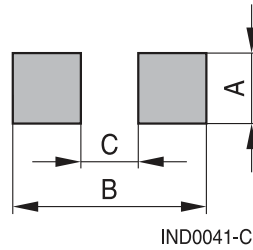
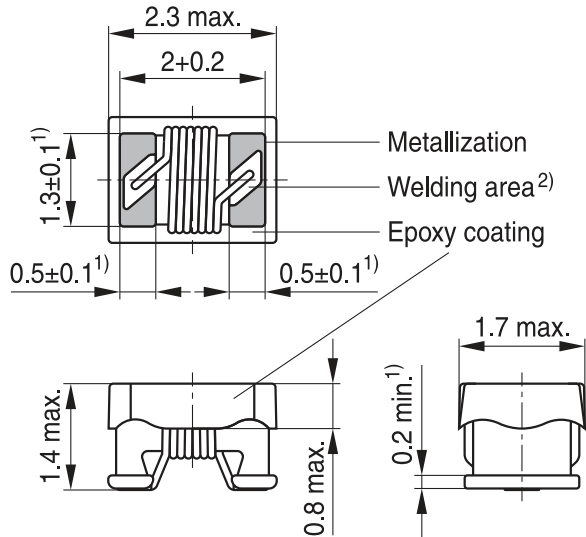

A	B	C
1.5 ±0.2	3.2 ±0.4	1.0 ±0.1

- 1) Soldering area
- 2) This area (30% of contact area) should not be used to assess solderability

IND0542-S-E

Dimensions in mm

**Taping and packing**

**Blister tape**

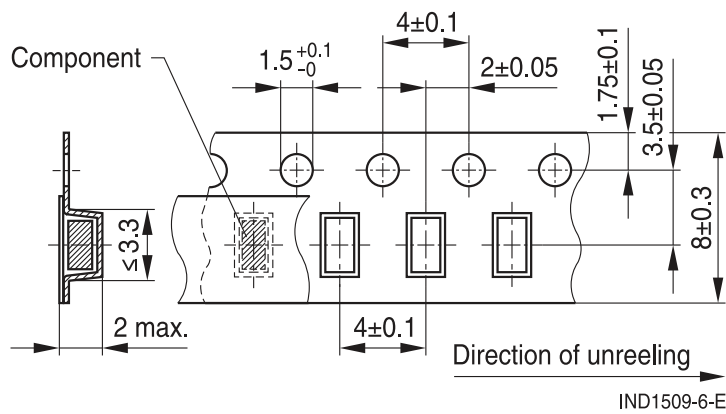

**Reel**



Dimensions in mm

**SMD**
**Technical data and measuring conditions**

Rated inductance $L_R$	Measured with impedance analyzer Agilent E4991A or equivalent at frequency $f_L$ , 0.1 V, +20 °C
Q factor $Q_{\min}$	Measured with impedance analyzer Agilent E4991A or equivalent at frequency $f_Q$ , +20 °C
Rated temperature $T_R$	+105 °C
Rated current $I_R$	Maximum permissible DC with inductance decrease $\Delta L/L_0 \leq 10\%$ and temperature increase of $\leq 20$ K at rated temperature
Self-resonance frequency $f_{\text{res},\min}$	Measured with network analyzer Agilent E8362B and/or Agilent E4991A or equivalent, +20 °C
DC resistance $R_{\max}$	Measured at +20 °C
Solderability (lead-free)	Sn95.5Ag3.8Cu0.7: +(245 ±5) °C, (5 ±0.3) s Wetting of soldering area $\geq 90\%$ (based on IEC 60068-2-58)
Resistance to soldering heat	+260 °C, 20 s
Climatic category	55/125/56 (to IEC 60068-1)
Storage conditions	Mounted: -55 °C ... +125 °C Packaged: -25 °C ... +40 °C, $\leq 75\%$ RH
Weight	Approx. 10 mg

**SMD**
**Characteristics and ordering codes**

$L_R$ nH	Tolerance	$f_L$ MHz	$Q_{min}$	$f_Q$ MHz	$I_R$ mA	$R_{max}$ $\Omega$	$f_{res,min}$ MHz	Ordering code <sup>1)</sup>
Core material: ceramic								
2.7	$\pm 10\% \triangleq K$	250	50	1500	1000	0.03	9000	B82498F3279K000
5.6		250	50	1000	900	0.04	7000	B82498F3569K000
6.8		250	50	1000	800	0.05	6000	B82498F3689K000
8.2		250	50	1000	700	0.09	5000	B82498F3829K000
10	$\pm 2\% \triangleq G$ $\pm 5\% \triangleq J$	250	50	500	700	0.09	5000	B82498F3100+000
12		250	50	500	700	0.09	4000	B82498F3120+000
15		250	50	500	650	0.13	3300	B82498F3150+000
18		250	60	500	700	0.08	3300	B82498F3180+000
22		250	60	500	700	0.08	2500	B82498F3220+000
27		250	60	500	700	0.09	2500	B82498F3270+000
33		250	65	500	600	0.11	2200	B82498F3330+000
39		250	65	500	600	0.12	2100	B82498F3390+000
47		200	65	500	600	0.13	2000	B82498F3470+000
56		200	60	500	600	0.14	1700	B82498F3560+000
68		200	60	500	500	0.18	1600	B82498F3680+000
82		150	60	500	500	0.19	1500	B82498F3820+000
100		150	55	500	450	0.28	1350	B82498F3101+000
120		150	50	250	440	0.31	1250	B82498F3121+000
150		100	45	250	400	0.42	1150	B82498F3151+000
180		100	45	250	340	0.53	1050	B82498F3181+000
220		100	45	250	320	0.70	950	B82498F3221+000
270		100	45	250	270	1.0	900	B82498F3271+000
330	100	45	250	220	1.5	800	B82498F3331+000	
390	100	40	250	210	1.6	700	B82498F3391+000	
470	50	30	100	190	1.9	650	B82498F3471+000	
560	25	23	50	230	1.3	400	B82498F3561+000	
680	25	23	50	190	1.7	300	B82498F3681+000	
820	25	23	50	180	1.9	300	B82498F3821+000	

1) Replace the + by the code letter for the required inductance tolerance.

**SMD**
**Characteristics and ordering codes**

$L_R$ nH	Tolerance	$f_L$ MHz	$Q_{min}$	$f_Q$ MHz	$I_R$ mA	$R_{max}$ $\Omega$	$f_{res,min}$ MHz	Ordering code
Core material: ferrite								
1000	$\pm 5\% \triangleq J$	7.96	20	7.96	240	0.55	440	B82498F1102J000
1200		7.96	20	7.96	220	0.65	420	B82498F1122J000
1500		7.96	20	7.96	200	0.70	380	B82498F1152J000
1800		7.96	20	7.96	190	0.98	350	B82498F1182J000
2200		7.96	20	7.96	130	1.60	330	B82498F1222J000
2700		7.96	20	7.96	120	2.0	270	B82498F1272J000
3300		7.96	20	7.96	100	3.3	250	B82498F1332J000
3900		7.96	20	7.96	95	3.6	230	B82498F1392J000
4700		7.96	20	7.96	90	3.8	210	B82498F1472J000
5600		7.96	20	7.96	85	4.3	180	B82498F1562J000
6800		7.96	20	7.96	80	4.7	140	B82498F1682J000

**SMD**

**Impedance  $|Z|$  vs. frequency  $f$  (ceramic core)**  
 measured with impedance analyzer  
 Agilent E4991A, typical values at +20 °C



**Impedance  $|Z|$  vs. frequency  $f$  (ferrite core)**  
 measured with impedance analyzer  
 Agilent E4991A, typical values at +20 °C



**Q factor versus frequency  $f$  (ceramic core)**  
 measured with impedance analyzer  
 Agilent E4991A, typical values at +20 °C

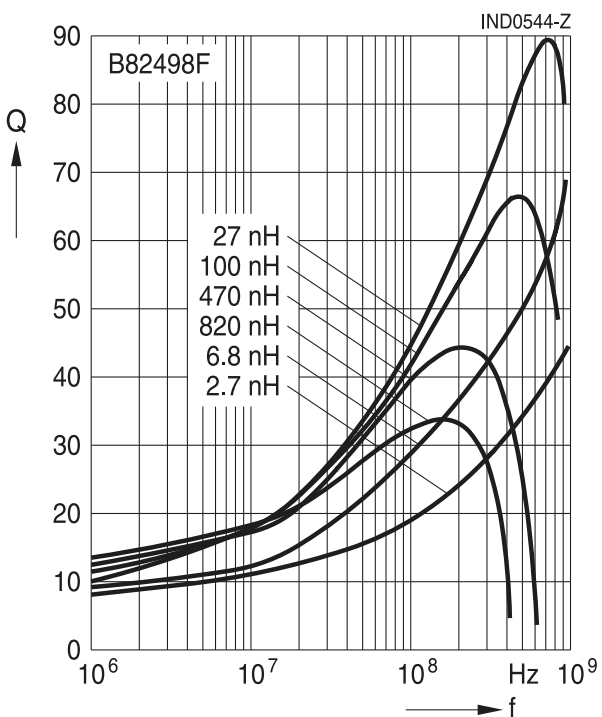

**Q factor versus frequency  $f$  (ferrite core)**  
 measured with impedance analyzer  
 Agilent E4991A, typical values at +20 °C

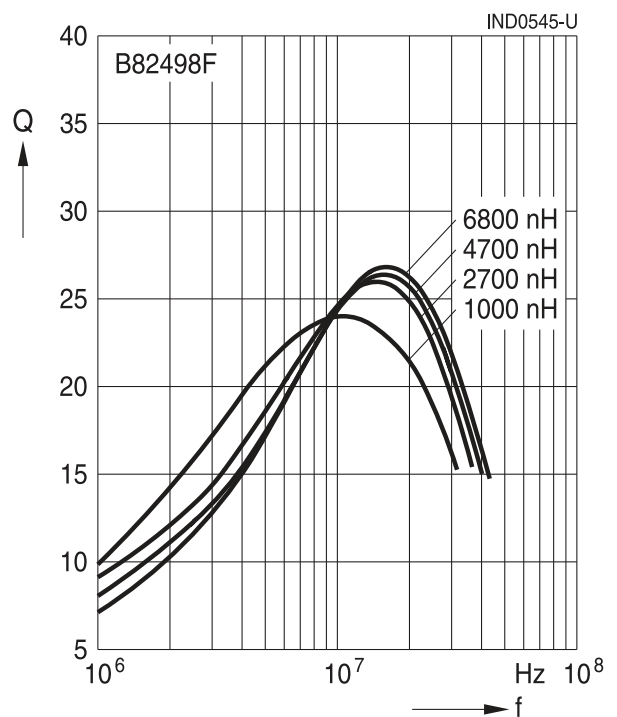

**SMD**

**Inductance L versus DC load current  $I_{DC}$**   
 measured with RF LCR meter  
 Agilent 4285A, typical values at +20 °C

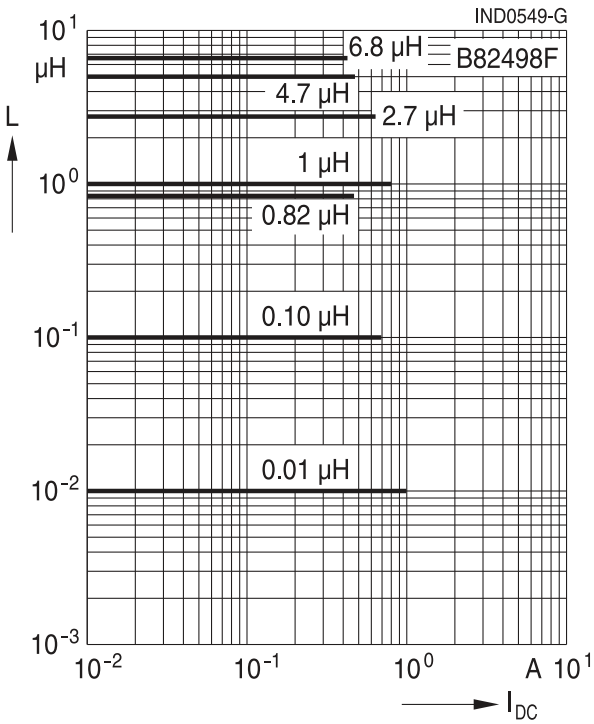

**Current derating  $I_{op}/I_R$**   
 versus ambient temperature  $T_A$   
 (rated temperature  $T_R = +105$  °C)

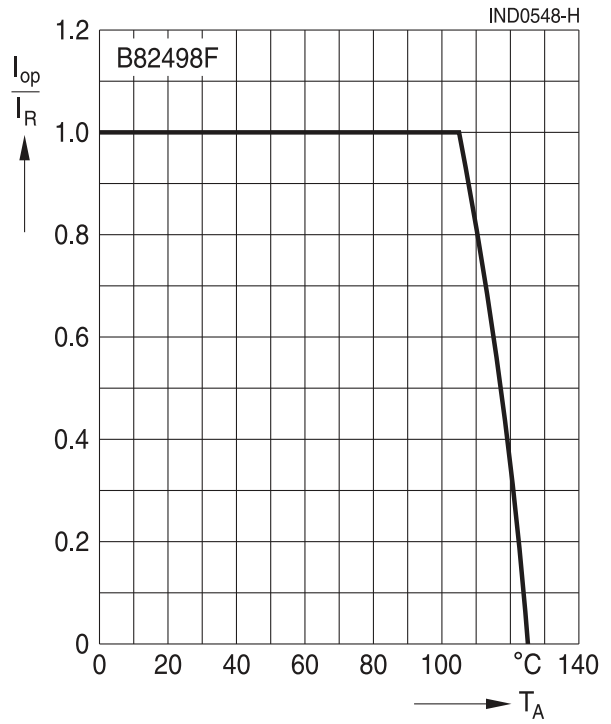



## Cautions and warnings

- Please note the recommendations in our Inductors data book (latest edition) and in the data sheets.
  - Particular attention should be paid to the derating curves given there.
  - The soldering conditions should also be observed. Temperatures quoted in relation to wave soldering refer to the pin, not the housing.
- If the components are to be washed varnished it is necessary to check whether the washing varnish agent that is used has a negative effect on the wire insulation, any plastics that are used, or on glued joints. In particular, it is possible for washing varnish agent residues to have a negative effect in the long-term on wire insulation.  
Washing processes may damage the product due to the possible static or cyclic mechanical loads (e.g. ultrasonic cleaning). They may cause cracks to develop on the product and its parts, which might lead to reduced reliability or lifetime.
- The following points must be observed if the components are potted in customer applications:
  - Many potting materials shrink as they harden. They therefore exert a pressure on the plastic housing or core. This pressure can have a deleterious effect on electrical properties, and in extreme cases can damage the core or plastic housing mechanically.
  - It is necessary to check whether the potting material used attacks or destroys the wire, wire insulation, plastics or glue.
  - The effect of the potting material can change the high-frequency behaviour of the components.
  - Many coating materials have a negative effect (chemically and mechanically) on the winding wires, insulation materials and connecting points. Customers are always obligated to determine whether and to what extent their coating materials influence the component.  
Customers are responsible and bear all risk for the use of the coating material. TDK Electronics does not assume any liability for failures of our components that are caused by the coating material.
- Ceramics / ferrites are sensitive to direct impact. This can cause the core material to flake, or lead to breakage of the core.
- Even for customer-specific products, conclusive validation of the component in the circuit can only be carried out by the customer.

### Display of ordering codes for TDK Electronics products

The ordering code for one and the same product can be represented differently in data sheets, data books, other publications, on the company website, or in order-related documents such as shipping notes, order confirmations and product labels. **The varying representations of the ordering codes are due to different processes employed and do not affect the specifications of the respective products.** Detailed information can be found on the Internet under [www.tdk-electronics.tdk.com/orderingcodes](http://www.tdk-electronics.tdk.com/orderingcodes).

## Important notes

The following applies to all products named in this publication:

1. Some parts of this publication contain **statements about the suitability of our products for certain areas of application**. These statements are based on our knowledge of typical requirements that are often placed on our products in the areas of application concerned. We nevertheless expressly point out **that such statements cannot be regarded as binding statements about the suitability of our products for a particular customer application**. As a rule, we are either unfamiliar with individual customer applications or less familiar with them than the customers themselves. For these reasons, it is always ultimately incumbent on the customer to check and decide whether a product with the properties described in the product specification is suitable for use in a particular customer application.
2. We also point out that **in individual cases, a malfunction of electronic components or failure before the end of their usual service life cannot be completely ruled out in the current state of the art, even if they are operated as specified**. In customer applications requiring a very high level of operational safety and especially in customer applications in which the malfunction or failure of an electronic component could endanger human life or health (e.g. in accident prevention or life-saving systems), it must therefore be ensured by means of suitable design of the customer application or other action taken by the customer (e.g. installation of protective circuitry or redundancy) that no injury or damage is sustained by third parties in the event of malfunction or failure of an electronic component.
3. **The warnings, cautions and product-specific notes must be observed.**
4. In order to satisfy certain technical requirements, **some of the products described in this publication may contain substances subject to restrictions in certain jurisdictions (e.g. because they are classed as hazardous)**. Useful information on this will be found in our Material Data Sheets on the Internet ([www.tdk-electronics.tdk.com/material](http://www.tdk-electronics.tdk.com/material)). Should you have any more detailed questions, please contact our sales offices.
5. We constantly strive to improve our products. Consequently, **the products described in this publication may change from time to time**. The same is true of the corresponding product specifications. Please check therefore to what extent product descriptions and specifications contained in this publication are still applicable before or when you place an order.  
We also **reserve the right to discontinue production and delivery of products**. Consequently, we cannot guarantee that all products named in this publication will always be available. The aforementioned does not apply in the case of individual agreements deviating from the foregoing for customer-specific products.
6. Unless otherwise agreed in individual contracts, **all orders are subject to our General Terms and Conditions of Supply**.

## Important notes

7. **Our manufacturing sites serving the automotive business apply the IATF 16949 standard.**  
The IATF certifications confirm our compliance with requirements regarding the quality management system in the automotive industry. Referring to customer requirements and customer specific requirements (“CSR”) TDK always has and will continue to have the policy of respecting individual agreements. Even if IATF 16949 may appear to support the acceptance of unilateral requirements, we hereby like to emphasize that **only requirements mutually agreed upon can and will be implemented in our Quality Management System.** For clarification purposes we like to point out that obligations from IATF 16949 shall only become legally binding if individually agreed upon.
8. The trade names EPCOS, CeraCharge, CeraDiode, CeraLink, CeraPad, CeraPlas, CSMP, CTVS, DeltaCap, DigiSiMic, ExoCore, FilterCap, FormFit, LeaXield, MiniBlue, MiniCell, MKD, MKK, MotorCap, PCC, PhaseCap, PhaseCube, PhaseMod, PhiCap, PowerHap, PQSine, PQvar, SIFERRIT, SIFI, SIKOREL, SilverCap, SIMDAD, SiMic, SIMID, SineFormer, SIOV, ThermoFuse, WindCap are **trademarks registered or pending** in Europe and in other countries. Further information will be found on the Internet at [www.tdk-electronics.tdk.com/trademarks](http://www.tdk-electronics.tdk.com/trademarks).

Release 2018-10

# Mouser Electronics

Authorized Distributor

Click to View Pricing, Inventory, Delivery & Lifecycle Information:

## EPCOS / TDK:

[B82498B1102J](#) [B82498F1102J](#) [B82498F1122J](#) [B82498F1152J](#) [B82498F1222J](#) [B82498F1332J](#) [B82498F1472J](#)  
[B82498F1562J](#) [B82498F1682J](#) [B82498F3100G000](#) [B82498F3120G000](#) [B82498F3150G000](#) [B82498F3180G000](#)  
[B82498F3220G000](#) [B82498F3270G000](#) [B82498F3330G000](#) [B82498F3390G000](#) [B82498F3470G000](#)  
[B82498F3560G000](#) [B82498F3680G000](#) [B82498F3820G000](#) [B82498F3101G000](#) [B82498F3121G000](#)  
[B82498F3151G000](#) [B82498F3181G000](#) [B82498F3221G000](#) [B82498F3271G000](#) [B82498F3331G000](#)  
[B82498F3391G000](#) [B82498F3471G000](#) [B82498F3561G000](#) [B82498F3681G000](#) [B82498F3821G000](#)  
[B82498F3181J000](#) [B82498F3271J000](#) [B82498F3391J000](#) [B82498F3561J000](#) [B82498F1102J001](#)  
[B82498F1182J001](#) [B82498F1392J001](#) [B82498F1472G001](#) [B82498F1472J001](#) [B82498F1681J000](#)  
[B82498F1392J000](#) [B82498F3330J000](#) [B82498F1182J000](#) [B82498F3560J000](#) [B82498F3829K000](#)  
[B82498F1272J000](#) [B82498F1821J000](#)



Компания «ЭлектроПласт» предлагает заключение долгосрочных отношений при поставках импортных электронных компонентов на взаимовыгодных условиях!

Наши преимущества:

- Оперативные поставки широкого спектра электронных компонентов отечественного и импортного производства напрямую от производителей и с крупнейших мировых складов;
- Поставка более 17-ти миллионов наименований электронных компонентов;
- Поставка сложных, дефицитных, либо снятых с производства позиций;
- Оперативные сроки поставки под заказ (от 5 рабочих дней);
- Экспресс доставка в любую точку России;
- Техническая поддержка проекта, помощь в подборе аналогов, поставка прототипов;
- Система менеджмента качества сертифицирована по Международному стандарту ISO 9001;
- Лицензия ФСБ на осуществление работ с использованием сведений, составляющих государственную тайну;
- Поставка специализированных компонентов (Xilinx, Altera, Analog Devices, Intersil, Interpoint, Microsemi, Aeroflex, Peregrine, Syfer, Eurofarad, Texas Instrument, Miteq, Cobham, E2V, MA-COM, Hittite, Mini-Circuits, General Dynamics и др.);

Помимо этого, одним из направлений компании «ЭлектроПласт» является направление «Источники питания». Мы предлагаем Вам помощь Конструкторского отдела:

- Подбор оптимального решения, техническое обоснование при выборе компонента;
- Подбор аналогов;
- Консультации по применению компонента;
- Поставка образцов и прототипов;
- Техническая поддержка проекта;
- Защита от снятия компонента с производства.



#### Как с нами связаться

**Телефон:** 8 (812) 309 58 32 (многоканальный)

**Факс:** 8 (812) 320-02-42

**Электронная почта:** [org@eplast1.ru](mailto:org@eplast1.ru)

**Адрес:** 198099, г. Санкт-Петербург, ул. Калинина, дом 2, корпус 4, литера А.