

### Product Description

Qorvo's TGA2514N-FL is a packaged Ku-band power amplifier operating from 13–16 GHz. Fabricated on Qorvo's production 0.25 um GaAs pHEMT process (QPHT25), the TGA2514N-FL delivers 6.5 W of saturated output power with 24 dB of small signal gain. Performance is ideal for VSAT transmitters, data links and point to point radios.

To support easy system integration, the TGA2514N-FL is offered in a 10-pin flange-mounted package, offering robust handling and good thermal management. In addition, both RF ports have integrated DC blocking capacitors and are fully matched to 50 ohms.

Lead free and RoHS compliant.

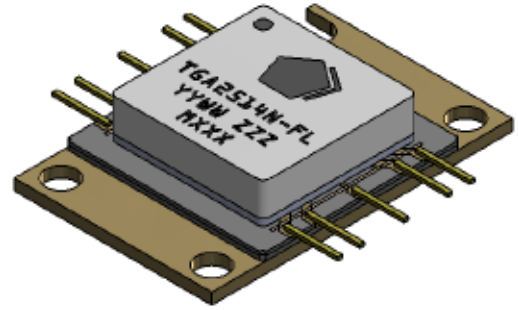

### Product Features

- Frequency Range: 13 – 16 GHz
- Saturated Output Power: 38 dBm
- Small Signal Gain: 24 dB
- Input and Output Return Loss: 14 dB
- Bias Condition (VD/IDQ): 8.0V/2.6 A
- Package Size: 0.448 x 0.682 x 0.120 inches (11.379 x 17.323 x 3.048 mm)

*Performance is typical across frequency. Please reference electrical specification table and data plots for more details*

### Functional Block Diagram

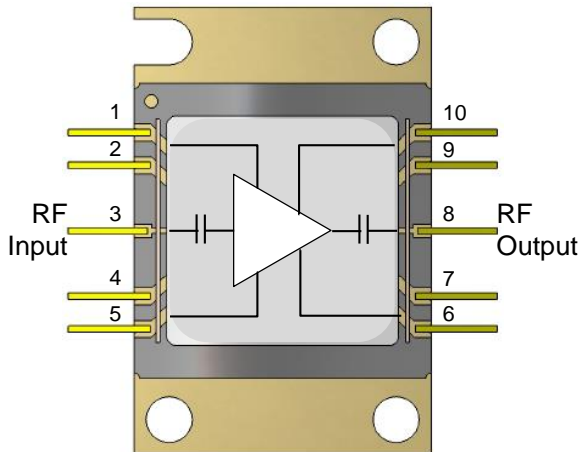

### Applications

- Ku Band VSAT Transmitter
- Point to Point Radio

### Ordering Information

Part No.	Description
TGA2514N-FL	13 – 16 GHz Power Amplifier
1127039	Evaluation Board



# TGA2514N-FL

## 13 – 18 GHz Power Amplifier

### Absolute Maximum Ratings

Parameter	Value / Range
Drain Voltage ( $V_D$ )	9.0 V
Drain Current ( $I_D$ )	3.8 A
Gate Voltage Range ( $V_G$ )	-5 to 0 V
Gate Current ( $I_G$ )	-18 to +18 mA
Input Power, CW ( $P_{IN}$ )	21 dBm
Power Dissipation ( $P_{DISS}$ )	33.3 W
Operating Channel Temperature	200 °C

Operation of this device outside the parameter ranges given above may cause permanent damage. These are stress ratings only, and functional operation of the device at these conditions is not implied.

### Recommended Operating Conditions

Parameter	Value / Range
Drain Voltage ( $V_D$ )	8.0 V
Gate Voltage ( $V_S$ )	-0.65 V
Drain Current ( $I_{DQ}$ )	2.6 A
Temperature Range	-40 to +85 °C

Electrical specifications are measured at specified test conditions. Specifications are not guaranteed over all recommended operating conditions.

### Electrical Specifications

Parameter	Min	Typ	Max	Units
Frequency Range	13		16	GHz
Small Signal Gain		24		dB
Saturated Output Power		38		dBm
Input Return Loss		14		dB
Output Return Loss		14		dB

Test conditions, unless otherwise noted: Temp = 25 °C,  $V_D$  = 8.0 V,  $I_{DQ}$  = 2.6 A

### Typical Performance – Small and Large Signal

Test conditions, unless otherwise noted: Temp = 25 °C,  $V_D = 8.0$  V,  $I_{DQ} = 2.6$  A

Gain and Return Loss vs. Frequency

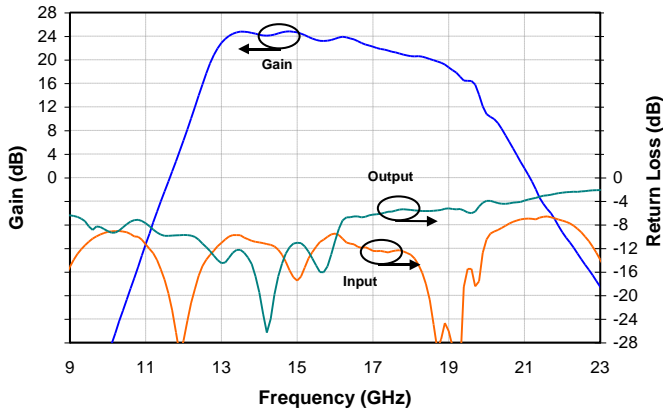

Gain vs. Frequency vs. Temperature

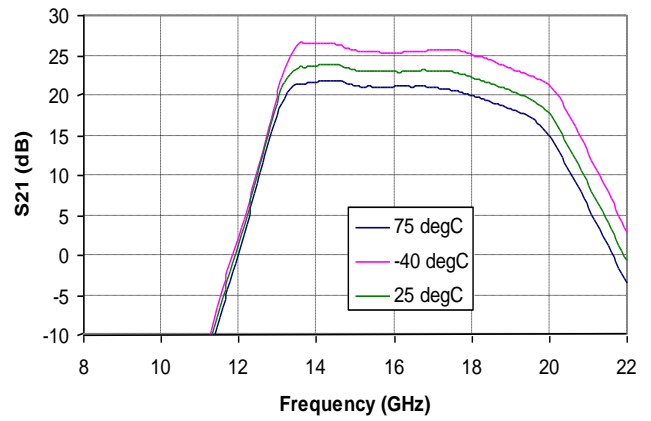

Saturated Output Power vs. Frequency

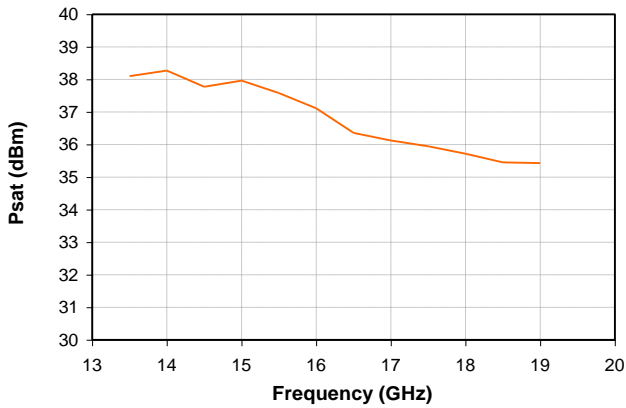

P1dB vs. Frequency vs. Temperature

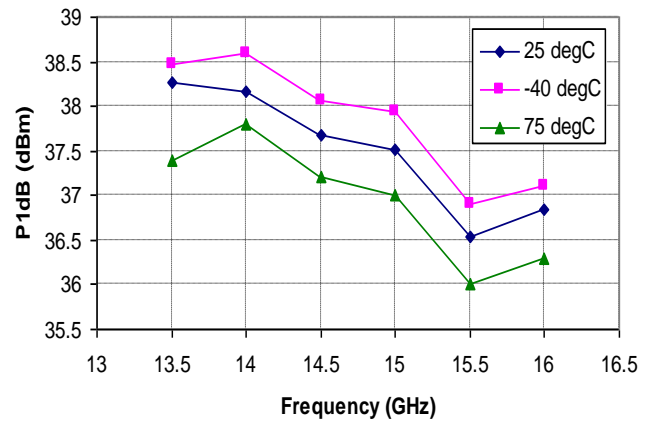

### Typical Performance – Large Signal

Test conditions, unless otherwise noted: Temp = 25 °C,  $V_D = 8.0$  V,  $I_{DQ} = 2.6$  A

Output Power vs. Input Power vs. Frequency

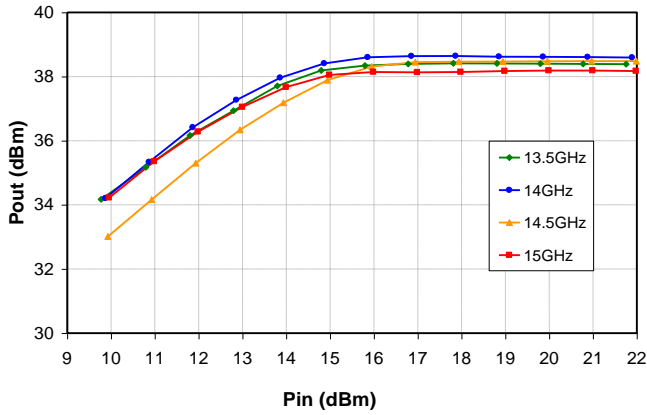

Gain vs. Input Power vs. Frequency

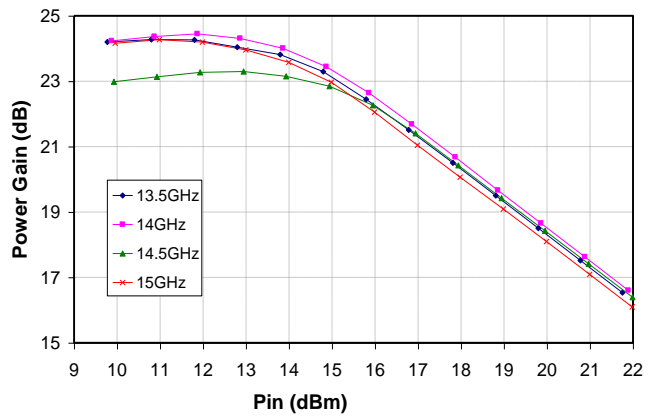

Drain Current vs. Input Power vs. Frequency

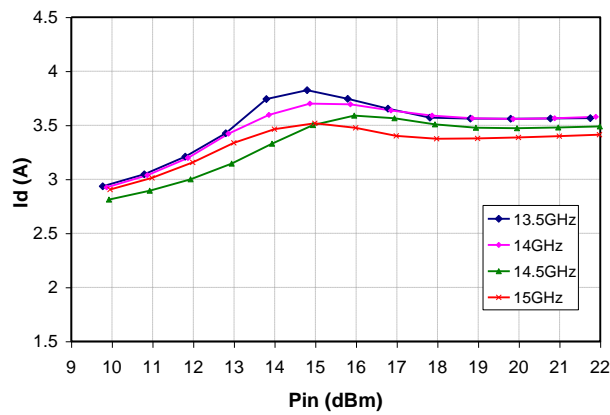

### Thermal and Reliability Information

Parameter	Test Conditions	Value	Units
Thermal Resistance ( $\theta_{JC}$ ) <sup>(1)</sup>	$T_{BASE} = 70\text{ }^{\circ}\text{C}$ , $V_D = 8\text{ V}$ $I_{DQ} = 2.6\text{ A}$ , $P_{DISS} = 20.8\text{ W}$	3.9	$^{\circ}\text{C/W}$
Channel Temperature ( $T_{CH}$ ) <sup>(1)</sup>		151	$^{\circ}\text{C}$
Median Lifetime ( $T_M$ )		9.3E5	Hrs
Thermal Resistance ( $\theta_{JC}$ ) <sup>(1)</sup>	$T_{BASE} = 70\text{ }^{\circ}\text{C}$ , $V_D = 8\text{ V}$ $I_{DQ} = 2.6\text{ A}$ , $P_{DISS} = 22.5\text{ W}$ (Under RF Drive)	3.9	$^{\circ}\text{C/W}$
Channel Temperature ( $T_{CH}$ ) <sup>(1)</sup>		158	$^{\circ}\text{C}$
Median Lifetime ( $T_M$ )		5.2E5	Hrs

Notes:

1. Thermal resistance is referenced to the back of package ( $70\text{ }^{\circ}\text{C}$ )

### Median Lifetime

Failure Criterion = 10% reduction in  $I_{D\text{ MAX}}$

Median Lifetime vs. Channel Temperature

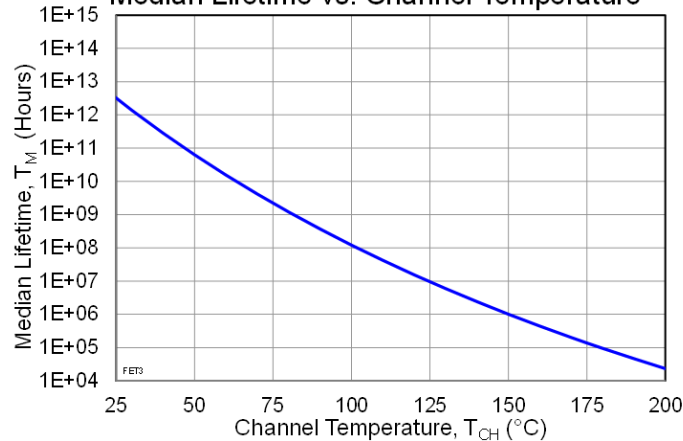

**Applications Circuit**

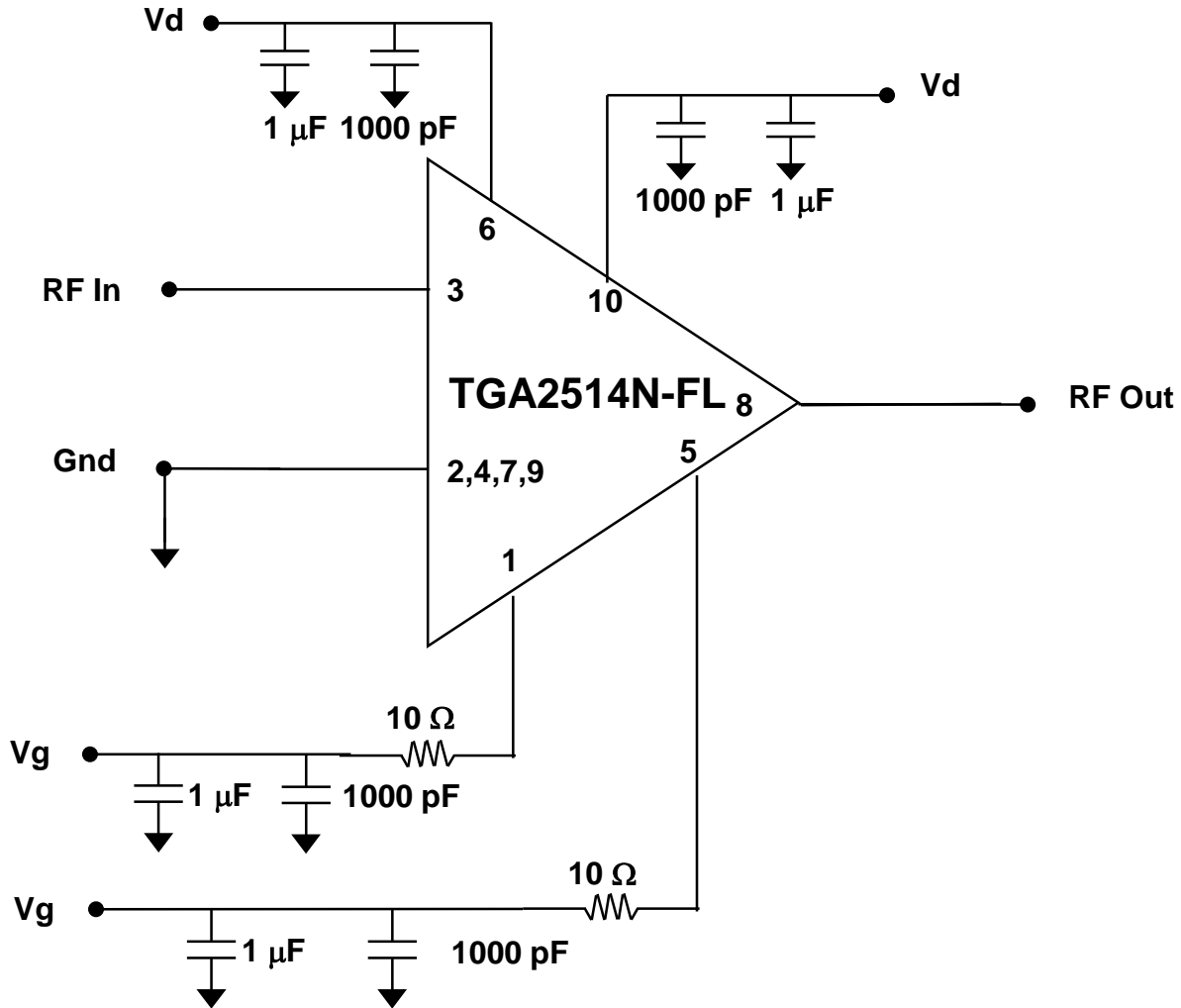

Notes:

1.  $V_G$  can be biased from either pin 1 or pin 5.
2.  $V_D$  must be biased from both sides (Pins 6 and 10)

**Bias Up Procedure**

1. Set  $I_D$  limit to 3.3 A,  $I_G$  limit to 18 mA
2. Apply  $-1.5\text{ V}$  to  $V_G$
3. Apply  $+8\text{ V}$  to  $V_D$ ; ensure  $I_{DQ}$  is approx. 0 mA
4. Adjust  $V_G$  until  $I_{DQ} = 2.6\text{ A}$  ( $V_G \sim -0.65\text{ V Typ.}$ ).
5. Turn on RF supply

**Bias Down Procedure**

1. Turn off RF supply
2. Reduce  $V_G$  to  $-1.5\text{ V}$ ; ensure  $I_{DQ}$  is approx. 0 mA
3. Set  $V_D$  to 0 V
4. Turn off  $V_D$  supply
5. Turn off  $V_G$  supply

## Evaluation Board (EVB) Assembly Drawing

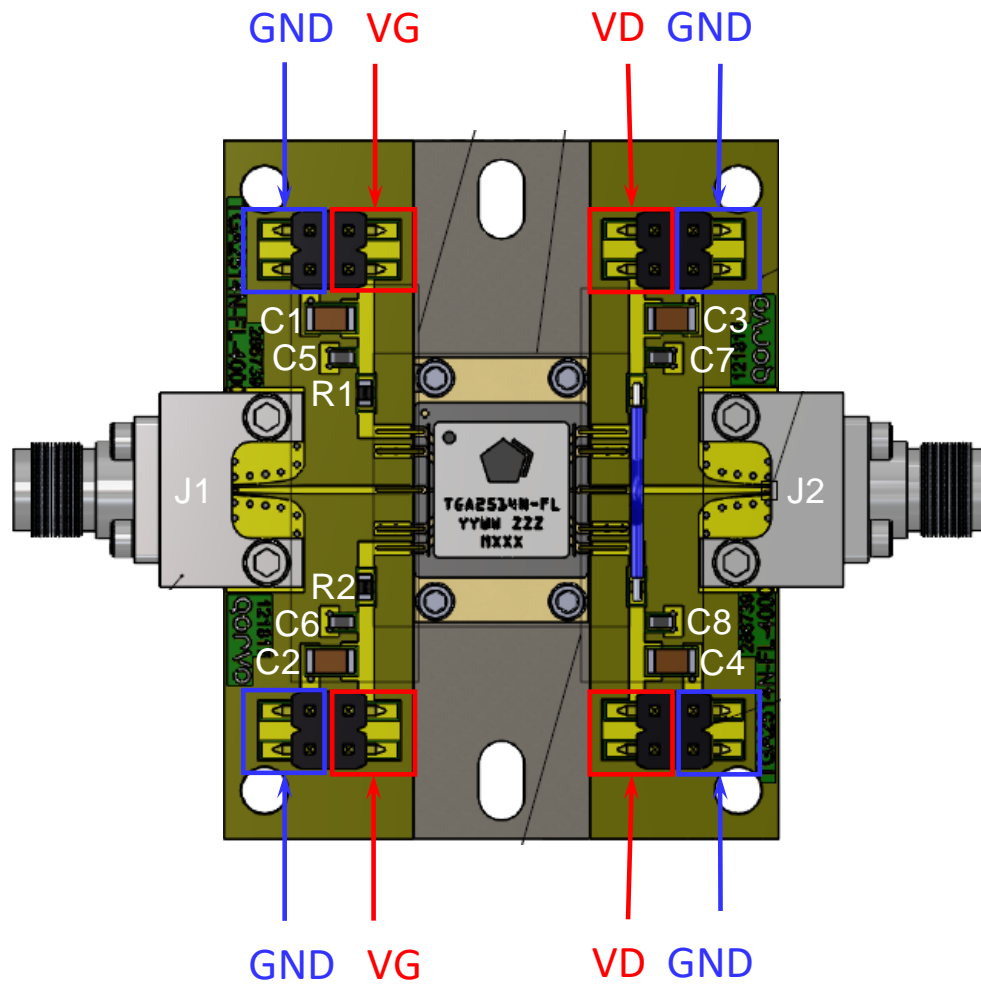

**PCB NOTES:**

1. RF Layer is 0.010" thick Rogers Corp. RO4350,  $\epsilon_r = 3.38$ . Metal layers are 0.5 oz. copper. The microstrip line at the connector interface is optimized for the Southwest Microwave end launch connector 1092-01A-5.

## Bill of Materials

Reference Des.	Value	Description	Manuf.	Part Number
C1, C2, C3, C4	1.0 uF	CAP, 1uF, 5% 50V, X7R, 1206	Various	–
C5, C6, C7, C8	1000 pF	CAP, 1000pF, 5%, 50V, NP0, 0603	Various	–
R1, R2	0 $\Omega$	RES, 0 OHM, 1/10W, 0603	Various	–
J1, J2	2.92 mm	CONNECTOR, FEMALE, ENDLAUNCH	Southwest Microwave	1092-01A-5



# TGA2514N-FL

## 13 – 18 GHz Power Amplifier

### Assembly Notes

---

1. Carefully clean the PC board and package leads with alcohol. Allow it to dry fully.
2. To improve the thermal and RF performance, Qorvo recommends attaching a heat sink to the bottom of the PCB and apply thermal compound (Arctic Silver 5 recommended) or a 4 mil indium shim between the heat sink and the package.
3. Apply no-flux solder to each pin of the TGA2514N-FL. The component leads should be manually soldered, and the package should not be subjected to conventional reflow processes. The use of no-clean solder to avoid washing after soldering is recommended.



### Mechanical Information

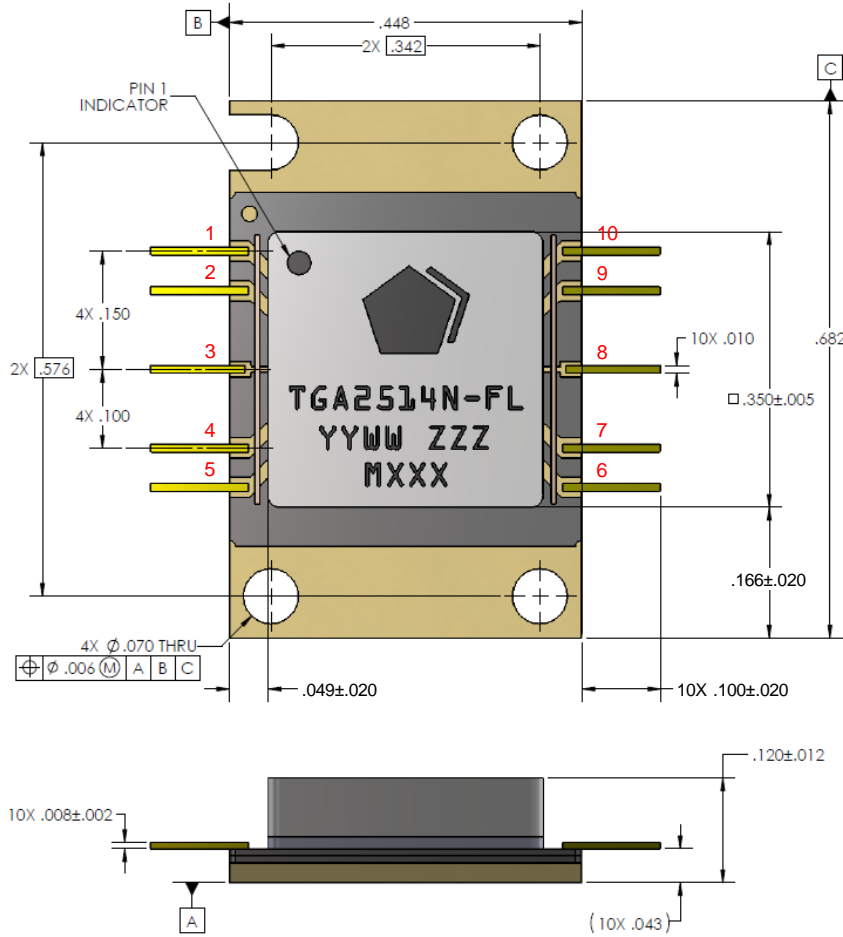

- NOTES:
1. **PACKAGE BASE:** CERAMIC ON METAL FLANGE.
  2. **PACKAGE LID:** PLASTIC.
  3. ALL METALIZED FEATURES ARE GOLD PLATED.
  4. THE PART IS EPOXY SEALED.
  5. **PART MARKING:**  
 TGA2514N-FL: PART NUMBER  
 YY: PART ASSY YEAR  
 WW: PART ASSY WEEK  
 ZZZ: SERIAL NUMBER  
 MXXX: BATCH ID

THE GENERAL TOLERANCE IS  $\pm .006$  UNLESS OTHERWISE SPECIFIED  
 ALL DIMENSIONS ARE IN INCHES

### Pin Description

Pad No.	Symbol	Description
1,5	$V_G$	Gate Voltage; bias network is required, part can be biased from either pin
2,4,7,9	GND	Ground
3	RF Input	RF Input; 50 $\Omega$ , AC coupled
6,10	$V_D$	Drain Voltage; bias network is required, part must be biased from both pins
8	RF Output	RF Output; 50 $\Omega$ , AC coupled

### Handling Precautions

Parameter	Rating	Standard
ESD – Human Body Model (HBM)	Class 0B	JEDEC Standard JESD22 A114
MSL – Moisture Sensitivity Level	3	JEDEC standard J-STD-020



Caution!  
ESD-Sensitive Device

### Solderability

The component leads should be manually soldered, and the package should not be subjected to conventional reflow processes. Soldering of the component leads is compatible with the latest version of J-STD-020, lead-free solder, 260 °C. The use of no-clean solder to avoid washing after soldering is recommended.

### RoHS Compliance

This product is compliant with the 2011/65/EU RoHS directive (Restrictions on the Use of Certain Hazardous Substances in Electrical and Electronic Equipment), as amended by Directive 2015/863/EU. This product also has the following attributes:

- Lead Free
- Halogen Free (Chlorine, Bromine)
- Antimony Free
- TBBP-A (C<sub>15</sub>H<sub>12</sub>Br<sub>4</sub>O<sub>2</sub>) Free
- PFOS Free
- SVHC Free

### Contact Information

For the latest specifications, additional product information, worldwide sales and distribution locations:

Web: [www.qorvo.com](http://www.qorvo.com)

Tel: 1-844-890-8163

Email: [customer.support@qorvo.com](mailto:customer.support@qorvo.com)

### Important Notice

The information contained herein is believed to be reliable; however, Qorvo makes no warranties regarding the information contained herein and assumes no responsibility or liability whatsoever for the use of the information contained herein. All information contained herein is subject to change without notice. Customers should obtain and verify the latest relevant information before placing orders for Qorvo products. The information contained herein or any use of such information does not grant, explicitly or implicitly, to any party any patent rights, licenses, or any other intellectual property rights, whether with regard to such information itself or anything described by such information. **THIS INFORMATION DOES NOT CONSTITUTE A WARRANTY WITH RESPECT TO THE PRODUCTS DESCRIBED HEREIN, AND QORVO HEREBY DISCLAIMS ANY AND ALL WARRANTIES WITH RESPECT TO SUCH PRODUCTS WHETHER EXPRESS OR IMPLIED BY LAW, COURSE OF DEALING, COURSE OF PERFORMANCE, USAGE OF TRADE OR OTHERWISE, INCLUDING THE IMPLIED WARRANTIES OF MERCHANTABILITY AND FITNESS FOR A PARTICULAR PURPOSE.**

Without limiting the generality of the foregoing, Qorvo products are not warranted or authorized for use as critical components in medical, life-saving, or life-sustaining applications, or other applications where a failure would reasonably be expected to cause severe personal injury or death.

Copyright 2019 © Qorvo, Inc. | Qorvo is a registered trademark of Qorvo, Inc.



Компания «ЭлектроПласт» предлагает заключение долгосрочных отношений при поставках импортных электронных компонентов на взаимовыгодных условиях!

Наши преимущества:

- Оперативные поставки широкого спектра электронных компонентов отечественного и импортного производства напрямую от производителей и с крупнейших мировых складов;
- Поставка более 17-ти миллионов наименований электронных компонентов;
- Поставка сложных, дефицитных, либо снятых с производства позиций;
- Оперативные сроки поставки под заказ (от 5 рабочих дней);
- Экспресс доставка в любую точку России;
- Техническая поддержка проекта, помощь в подборе аналогов, поставка прототипов;
- Система менеджмента качества сертифицирована по Международному стандарту ISO 9001;
- Лицензия ФСБ на осуществление работ с использованием сведений, составляющих государственную тайну;
- Поставка специализированных компонентов (Xilinx, Altera, Analog Devices, Intersil, Interpoint, Microsemi, Aeroflex, Peregrine, Syfer, Eurofarad, Texas Instrument, Miteq, Cobham, E2V, MA-COM, Hittite, Mini-Circuits, General Dynamics и др.);

Помимо этого, одним из направлений компании «ЭлектроПласт» является направление «Источники питания». Мы предлагаем Вам помощь Конструкторского отдела:

- Подбор оптимального решения, техническое обоснование при выборе компонента;
- Подбор аналогов;
- Консультации по применению компонента;
- Поставка образцов и прототипов;
- Техническая поддержка проекта;
- Защита от снятия компонента с производства.



#### Как с нами связаться

**Телефон:** 8 (812) 309 58 32 (многоканальный)

**Факс:** 8 (812) 320-02-42

**Электронная почта:** [org@eplast1.ru](mailto:org@eplast1.ru)

**Адрес:** 198099, г. Санкт-Петербург, ул. Калинина, дом 2, корпус 4, литера А.