

# POWER RELAY

## 1 POLE - 16A 80A Inrush type

### FTR-K1 Series

#### ■ FEATURES

- Peak 80A inrush current (1 form A type)
- Low profile (height: 15.7mm)
- High insulation  
Insulation distance (between coil and contacts): 10mm min.  
Dielectric strength: 5KV  
Surge strength: 10KV
- Class F coil wire
- Low coil power (400mW)
- Cadmium free contacts
- Safety standards  
UL, CSA, VDE, CQC approved  
UL, CSA TV-5 rating approved (1 form A type)
- Flux proof, RTII
- RoHS compliant  
Please see page 6 for more information

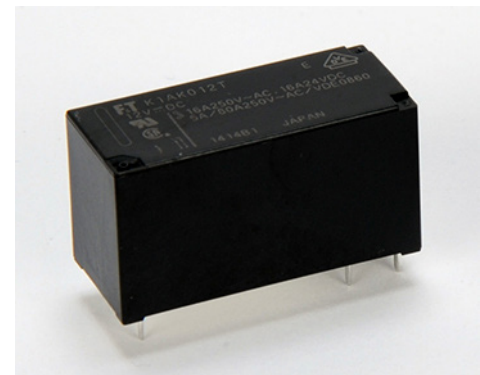

#### ■ PARTNUMBER INFORMATION

**[Example]**       $\frac{\text{FTR-K1}}{\text{(a)}} \quad \frac{\text{C}}{\text{(b)}} \quad \frac{\text{K}}{\text{(c)}} \quad \frac{\text{012}}{\text{(d)}} \quad \frac{\text{W}}{\text{(e)}} - \frac{\text{BG}}{\text{(f)}}$

(a)	Relay type	FTR-K1 : FTR-K1-Series
(b)	Contact configuration	A : 1 form A (SPST-NO) C : 1 form C (SPDT) (standard type "K" only)
(c)	Coil type / enclosure	K : Standard type (400mW) / flux proof
(d)	Coil rated voltage	012 : 5.....110 VDC Coil rating table at page 3
(e)	Contact material	W : AgSnO <sub>2</sub> (1 form C contact type only) T : AgSnO <sub>2</sub> / TV-5 rated (1 form A / TV-5 contact type only)
(f)	Special type	Nil : Standard type (without gold plate) BG : Gold plated 3 μm

Actual marking does not carry the type name : "FTR"  
E.g.: Ordering code: FTR-K1CK012W    Actual marking: K1CK012W

# FTR-K1 SERIES

## ■ SPECIFICATION

Item			FTR-K1 AK ( ) T Standard	FTR-K1 CK ( ) W Standard
Contact Data	Configuration		1 form A	1 form C
	Construction		Single	
	Material		AgSnO <sub>2</sub>	
	Resistance (initial)		Max. 100mΩ at 1A, 6VDC	
	Contact rating (resistive)		16A, 250VAC / 24VDC	
	Max. carrying current *1		20A	
	Max. inrush current		80A (20ms) 250VAC (only make contact)	
	Max. switching voltage		440VAC / 300VDC	
	Max. switching power		4,000VA / 384W	
	Min. switching load *2		100mA, 5VDC	
Life	Mechanical		Min. 20 x 10 <sup>6</sup> operations	
	Electrical	AC contact rating	Min. 100 x 10 <sup>3</sup> operations	Min. 50 x 10 <sup>3</sup> operations
		DC contact rating	Min. 100 x 10 <sup>3</sup> operations	Min. 30 x 10 <sup>3</sup> operations
		Peak Inrush (80A)	Min. 10 x 10 <sup>3</sup> operations (only make contact)	
	Lamp load (UL TV-5)	Min. 25 x 10 <sup>3</sup> operations	Min. 25 x 10 <sup>3</sup> operations (only make contact)	
Coil Data	Rated power (20 °C)		400mW (430mW at 48V coil)	
	Operate power (20 °C)		196mW (210mW at 48V coil)	
	Operating temperature range		-40 °C to +85 °C (no frost)	
Timing Data	Operate (at nominal voltage)		Max. 15ms (without bounce)	
	Release (at nominal voltage)		Max. 5ms (without bounce, no diode)	
Insulation	Resistance (initial)		Min. 1,000MΩ at 500VDC	
	Dielectric strength	Open contacts	1,000VAC (50/60Hz) 1min	
		Contacts to coil	5,000VAC (50/60Hz) 1min	
	Surge strength	Coil to contacts	10,000V / 1.2 x 50μs standard wave	
	Clearance		10mm	
	Creepage		10mm	
	EN61810-1, VDE0435	Voltage	250V	
		Pollution degree	3	
		Material group	III a	
	Category	C / 250V (Reference voltage) (VDE0110b)		
Other	Vibration resistance	Misoperation≥1us	10 to 55Hz double amplitude 0.7mm	
		Endurance	10 to 55Hz double amplitude 1.5mm	
	Shock	Misoperation≥1us	100m/s <sup>2</sup> (11 ± 1ms)	
		Endurance	1,000m/s <sup>2</sup> (6 ± 1ms)	
	Weight		Approximately 13g	
	Sealing		Flux proof, RTII	

\* 1: Need to consider the heat from PCB when max. current is more than 10A.

\* 2: Minimum switching loads mentioned above are reference values. Please perform the confirmation test with actual load before production since reference values may vary according to switching frequencies, environmental conditions and expected reliability levels.

# FTR-K1 SERIES

## ■ COIL RATING

Coil Code	Rated Coil Voltage (VDC)	Coil Resistance +/- 10% (Ohm)	Must Operate Voltage (VDC) *	Must Release-Voltage (VDC) *	Rated Power (mW)
005	5	62	3.5	0.5	400
006	6	90	4.2	0.6	
009	9	202	6.3	0.9	
012	12	360	8.4	1.2	
018	18	810	12.6	1.8	
022	22	1,210	15.4	2.2	
024	24	1,440	16.8	2.4	
028	28	1,960	19.6	2.8	430
048	48	5,360	33.6	4.8	
060	60	8,570	42.0	6.0	
110	110	28,800	77.0	11.0	420

Note: All values in the table are valid for 20°C and zero contact current.  
\* Specified operate values are valid for pulse wave voltage.

## ■ SAFETY STANDARDS

Type	Compliance	Contact rating	
		1a	1c
UL	UL 508 E63614	Flammability: UL 94-V0 (plastics)	
		FTR-K1AK ( ) T (-BG) 16A, 24VDC (resistive) 16A, 277VAC (resistive) 20A, 277VAC (resistive) 1 hp, 277VAC 1/2 hp, 125VAC TV-5, 120VAC 25,000 cycles Pilot duty: A300	FTR-K1CK ( ) W (-BG) 16A, 277VAC/24VDC (resistive) 20A, 277VAC (resistive) 1 hp 277VAC 1/2 hp, 125VAC 1/8 hp, 125VAC TV-5, 250VAC, 25,000 cycles (only make contact) Pilot duty: B300
CSA	C22.2 No. 14 LR 40304		FTR-K1CK ( ) W (-BG) 16A, 277VAC/24VDC (resistive) 20A, 277VAC (resistive) 1 hp 277VAC 1/2 hp, 125VAC 1/8 hp, 125VAC TV-5, 120VAC (only make contact) Pilot duty: B300
VDE	IEC/EN61810-1 EN60065 EN60335-1 clause 15.3; 16.3; 29.1; 29.2; 29.3 EN60730 clause 12.2; 13.2; 20.1; 20.2; 20.3,17.5; 17.7; 17.8	FTR-K1AK ( ) T (-BG) 16A, 250VAC (cosφ=1), 85°C 3.5A, 250VAC (cosφ=0.4), 85°C 16A, 24VDC (0ms), 85°C 5A/80A, 250VAC 10,000 times, 85°C	FTR-K1CK ( ) W (-BG) 16A, 250VAC (cosφ=1), 85°C 3.5A, 250VAC (cosφ=0.4), 85°C 16A, 24VDC (0ms), 85°C
CQC	GB/T21711.1 GB15092 12002083788	FTR-K1AK ( ) T 12A, 240VAC 72LRA/12FLA 240VAC	FTR-K1CK ( ) W 16A, 250VAC

# FTR-K1 SERIES

## CHARACTERISTIC DATA

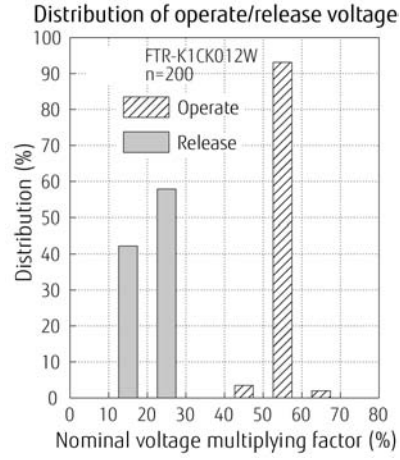
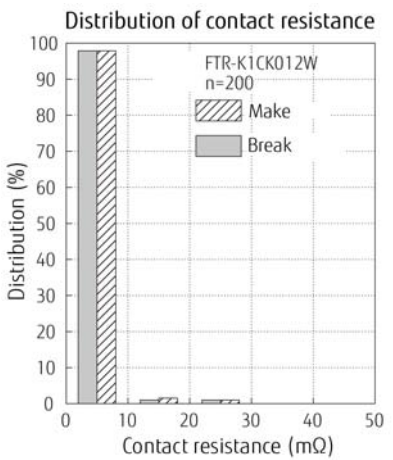
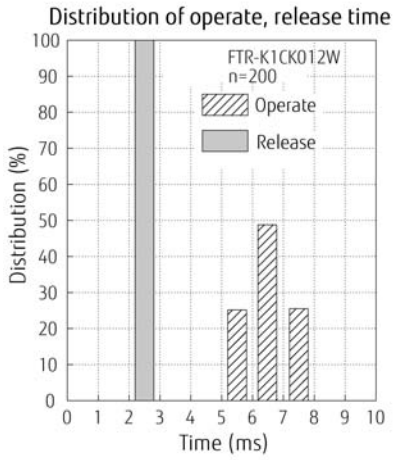
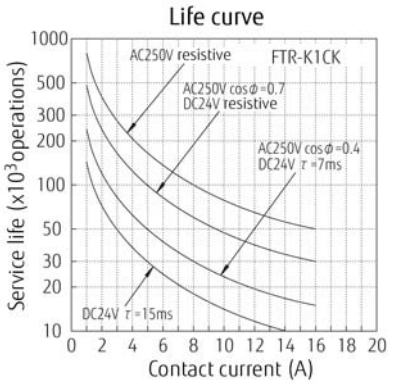
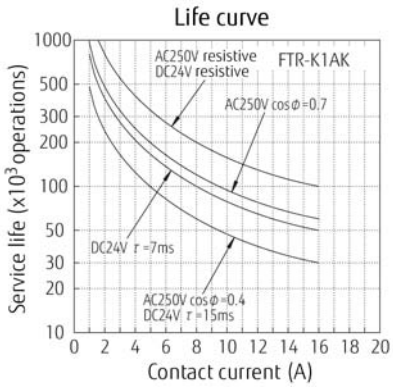
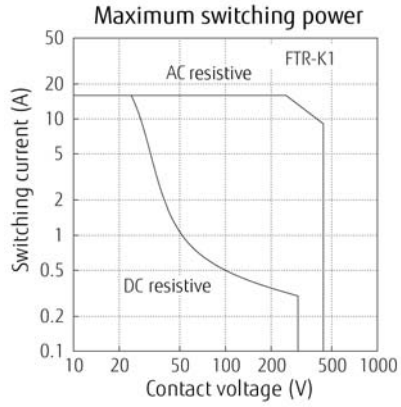
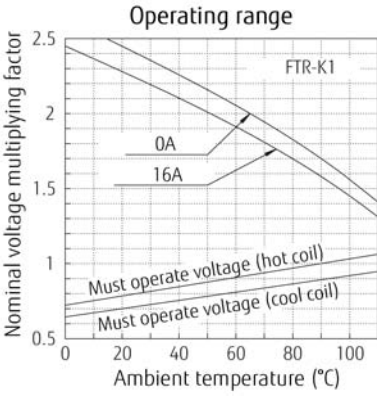
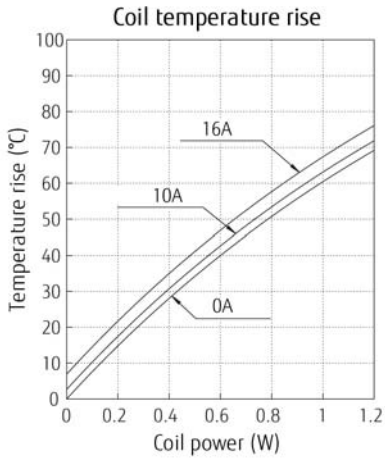

# FTR-K1 SERIES

## ■ DIMENSIONS

FTR-K1AK( )T

### ● Dimensions

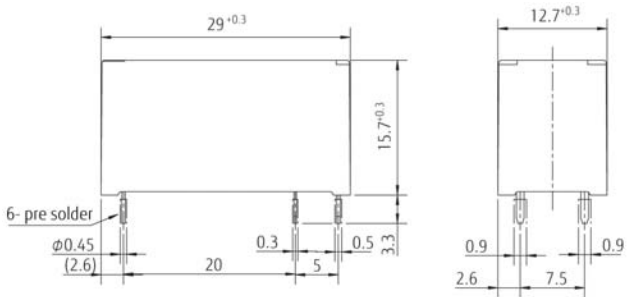

### ● Schematics

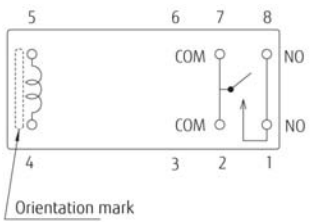

### ● PC board mounting hole layout (BOTTOM VIEW)

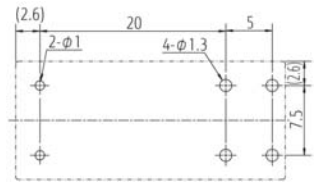

Connect terminal #1 and #8 on the PCB board

FTR-K1CK( )W

### ● Dimensions

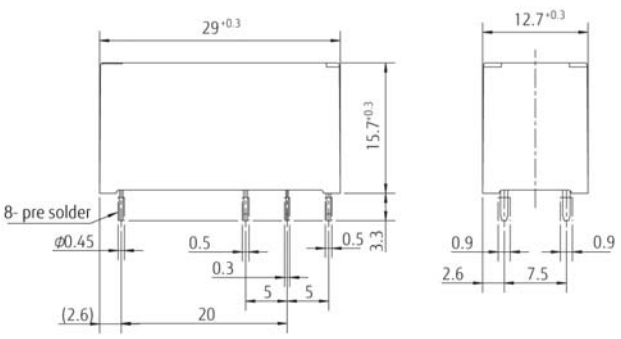

### ● Schematics

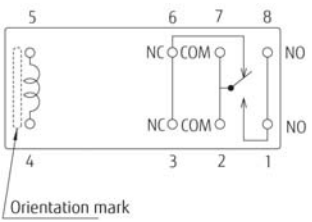

### ● PC board mounting hole layout (BOTTOM VIEW)

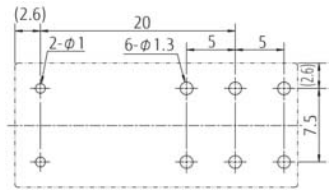

Connect terminal #1 and #8 on the PCB board

Unit: mm

## RoHS Compliance and Lead Free Information

### 1. General Information

- All relays produced by Fujitsu Components are compliant with RoHS directive 2011/65/EU including amendments.
- Cadmium as used in electrical contacts is exempted from the RoHS directives. As per Annex III of directive 2011/65/EU.
- All relays are lead-free. Please refer to Lead-Free Status Info for older date codes at: <http://www.fujitsu.com/downloads/MICRO/fcai/relays/lead-free-letter.pdf>
- Lead free solder plating on relay terminals is Sn-3.0Ag-0.5Cu, unless otherwise specified. This material has been verified to be compatible with PbSn assembly process.

### 2. Recommended Lead Free Solder Condition

- Recommended solder Sn-3.0Ag-0.5Cu.

#### Flow Solder Condition:

Pre-heating: maximum 120 °C  
within 90 sec.  
Soldering: dip within 5 sec. at  
255 °C ± 5 °C solder bath  
Relay must be cooled by air immediately  
after soldering

#### Solder by Soldering Iron:

Soldering Iron 30-60W  
Temperature: maximum 350-360 °C  
Duration: maximum 3 sec.

**We highly recommend that you confirm your actual solder conditions**

### 3. Moisture Sensitivity

- Moisture Sensitivity Level standard is not applicable to electromechanical relays, unless otherwise indicated.

### 4. Tin Whiskers

- Dipped SnAgCu solder is known as presenting a low risk to tin whisker development. No considerable length whisker was found by our in house test.

## Fujitsu Components International Headquarter Offices

### Japan

Fujitsu Component Limited  
Gotanda-Chuo Building  
3-5, Higashigotanda 2-chome, Shinagawa-ku  
Tokyo 141, Japan  
Tel: (81-3) 5449-7010  
Fax: (81-3) 5449-2626  
Email: [promothq@ft.ed.fujitsu.com](mailto:promothq@ft.ed.fujitsu.com)  
Web: [www.fcl.fujitsu.com](http://www.fcl.fujitsu.com)

### North and South America

Fujitsu Components America, Inc.  
250 E. Caribbean Drive  
Sunnyvale, CA 94089 U.S.A.  
Tel: (1-408) 745-4900  
Fax: (1-408) 745-4970  
Email: [components@us.fujitsu.com](mailto:components@us.fujitsu.com)  
Web: <http://us.fujitsu.com/components>

### Europe

Fujitsu Components Europe B.V.  
Diamantlaan 25  
2132 WV Hoofddorp  
Netherlands  
Tel: (31-23) 5560910  
Fax: (31-23) 5560950  
Email: [info@fceu.fujitsu.com](mailto:info@fceu.fujitsu.com)  
Web: [emea.fujitsu.com/components/](http://emea.fujitsu.com/components/)

### Asia Pacific

Fujitsu Components Asia Ltd.  
102E Pasir Panjang Road  
#01-01 Citilink Warehouse Complex  
Singapore 118529  
Tel: (65) 6375-8560  
Fax: (65) 6273-3021  
Email: [fcsl@fcal.fujitsu.com](mailto:fcsl@fcal.fujitsu.com)  
Web: <http://www.fujitsu.com/sg/services/micro/components/>

©2014 Fujitsu Components Europe B.V. All rights reserved. All trademarks or registered trademarks are the property of their respective owners.

The contents, data and information in this datasheet are provided by Fujitsu Component Ltd. as a service only to its user and only for general information purposes.

The use of the contents, data and information provided in this datasheet is at the users' own risk.

Fujitsu has assembled this datasheet with care and will endeavor to keep the contents, data and information correct, accurate, comprehensive, complete and up to date.

Fujitsu Components Europe B.V. and affiliated companies do however not accept any responsibility or liability on their behalf, nor on behalf of its employees, for any loss or damage, direct, indirect or consequential, with respect to this datasheet, its contents, data, and information and related graphics and the correctness, reliability, accuracy, comprehensiveness, usefulness, availability and completeness thereof.

Nor do Fujitsu Components Europe B.V. and affiliated companies accept on their behalf, nor on behalf of its employees, any responsibility or liability for any representation or warrant of any kind, express or implied, including warranties of any kind for merchantability or fitness for particular use, with respect to these datasheets, its contents, data, information and related graphics and the correctness, reliability, accuracy, comprehensiveness, usefulness, availability and completeness thereof. Rev. May 08, 2014



Компания «ЭлектроПласт» предлагает заключение долгосрочных отношений при поставках импортных электронных компонентов на взаимовыгодных условиях!

Наши преимущества:

- Оперативные поставки широкого спектра электронных компонентов отечественного и импортного производства напрямую от производителей и с крупнейших мировых складов;
- Поставка более 17-ти миллионов наименований электронных компонентов;
- Поставка сложных, дефицитных, либо снятых с производства позиций;
- Оперативные сроки поставки под заказ (от 5 рабочих дней);
- Экспресс доставка в любую точку России;
- Техническая поддержка проекта, помощь в подборе аналогов, поставка прототипов;
- Система менеджмента качества сертифицирована по Международному стандарту ISO 9001;
- Лицензия ФСБ на осуществление работ с использованием сведений, составляющих государственную тайну;
- Поставка специализированных компонентов (Xilinx, Altera, Analog Devices, Intersil, Interpoint, Microsemi, Aeroflex, Peregrine, Syfer, Eurofarad, Texas Instrument, Miteq, Cobham, E2V, MA-COM, Hittite, Mini-Circuits, General Dynamics и др.);

Помимо этого, одним из направлений компании «ЭлектроПласт» является направление «Источники питания». Мы предлагаем Вам помощь Конструкторского отдела:

- Подбор оптимального решения, техническое обоснование при выборе компонента;
- Подбор аналогов;
- Консультации по применению компонента;
- Поставка образцов и прототипов;
- Техническая поддержка проекта;
- Защита от снятия компонента с производства.



#### Как с нами связаться

**Телефон:** 8 (812) 309 58 32 (многоканальный)

**Факс:** 8 (812) 320-02-42

**Электронная почта:** [org@eplast1.ru](mailto:org@eplast1.ru)

**Адрес:** 198099, г. Санкт-Петербург, ул. Калинина, дом 2, корпус 4, литера А.