

SOP-8



Pin Definition:

- | | |
|-------------|------------|
| 1. Source 1 | 8. Drain 1 |
| 2. Gate 1 | 7. Drain 1 |
| 3. Source 2 | 6. Drain 2 |
| 4. Gate 2 | 5. Drain 2 |

PRODUCT SUMMARY

| V_{DS} (V) | $R_{DS(on)}$ (m Ω) | I_D (A) |
|--------------|----------------------------|-----------|
| -30 | 25 @ $V_{GS} = -10V$ | -7.1 |
| | 41 @ $V_{GS} = -4.5V$ | -5.5 |

Features

- Advance Trench Process Technology
- High Density Cell Design for Ultra Low On-resistance

Application

- Load Switches
- Notebook PCs
- Desktop PCs

Ordering Information

| Part No. | Package | Packing |
|---------------|---------|--------------------|
| TSM4925DCS RL | SOP-8 | 2.5Kpcs / 13" Reel |

Block Diagram

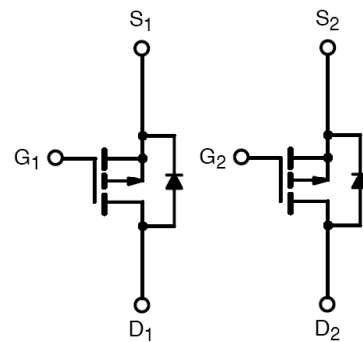

Dual P-Channel MOSFET

Absolute Maximum Rating (Ta = 25°C unless otherwise noted)

| Parameter | Symbol | Limit | Unit |
|---|----------------|--------------|------|
| Drain-Source Voltage | V_{DS} | -30 | V |
| Gate-Source Voltage | V_{GS} | ± 20 | V |
| Continuous Drain Current | I_D | -7.1 | A |
| Pulsed Drain Current | I_{DM} | -40 | A |
| Continuous Source Current (Diode Conduction) ^{a,b} | I_S | -1.7 | A |
| Maximum Power Dissipation | P_D | Ta = 25°C | 2.0 |
| | | Ta = 75°C | 1.3 |
| Operating Junction Temperature | T_J | +150 | °C |
| Operating Junction and Storage Temperature Range | T_J, T_{STG} | - 55 to +150 | °C |

Thermal Performance

| Parameter | Symbol | Limit | Unit |
|--|----------------|-------|------|
| Junction to Case Thermal Resistance | $R\theta_{JC}$ | 30 | °C/W |
| Junction to Ambient Thermal Resistance (PCB mounted) | $R\theta_{JA}$ | 50 | °C/W |

Notes:

- Pulse width limited by the Maximum junction temperature
- Surface Mounted on FR4 Board, $t \leq 10$ sec.

Electrical Specifications (Ta = 25°C unless otherwise noted)

| Parameter | Conditions | Symbol | Min | Typ | Max | Unit |
|---|---|--------------|-----|------|-----------|------------|
| Static | | | | | | |
| Drain-Source Breakdown Voltage | $V_{GS} = 0V, I_D = -250\mu A$ | BV_{DSS} | -30 | -- | -- | V |
| Gate Threshold Voltage | $V_{DS} = V_{GS}, I_D = -250\mu A$ | $V_{GS(TH)}$ | -1 | -- | -3 | V |
| Gate Body Leakage | $V_{GS} = \pm 20V, V_{DS} = 0V$ | I_{GSS} | -- | -- | ± 100 | nA |
| Zero Gate Voltage Drain Current | $V_{DS} = -30V, V_{GS} = 0V$ | I_{DSS} | -- | -- | -1.0 | μA |
| On-State Drain Current ^a | $V_{DS} = -5V, V_{GS} = -10V$ | $I_{D(ON)}$ | -40 | -- | -- | A |
| Drain-Source On-State Resistance ^a | $V_{GS} = -10V, I_D = -7.1A$ | $R_{DS(ON)}$ | -- | 20 | 25 | m Ω |
| | $V_{GS} = -4.5V, I_D = -5.5A$ | | -- | 33 | 41 | |
| Forward Transconductance ^a | $V_{DS} = -10V, I_D = -7.1A$ | g_{fs} | -- | 24 | -- | S |
| Diode Forward Voltage | $I_S = -1.7A, V_{GS} = 0V$ | V_{SD} | -- | -0.8 | -1.2 | V |
| Dynamic^b | | | | | | |
| Total Gate Charge | $V_{DS} = -15V, I_D = -7.1A, V_{GS} = -10V$ | Q_g | -- | 33 | 70 | nC |
| Gate-Source Charge | | Q_{gs} | -- | 5.8 | -- | |
| Gate-Drain Charge | | Q_{gd} | -- | 8.6 | -- | |
| Input Capacitance | $V_{DS} = -15V, V_{GS} = 0V, f = 1.0MHz$ | C_{iss} | -- | 1573 | 1900 | pF |
| Output Capacitance | | C_{oss} | -- | 319 | -- | |
| Reverse Transfer Capacitance | | C_{rss} | -- | 211 | 295 | |
| Switching^c | | | | | | |
| Turn-On Delay Time | $V_{DD} = -15V, R_L = 15\Omega, I_D = -1A, V_{GEN} = -10V, R_G = 6\Omega$ | $t_{d(on)}$ | -- | 10 | 15 | nS |
| Turn-On Rise Time | | t_r | -- | 15 | 25 | |
| Turn-Off Delay Time | | $t_{d(off)}$ | -- | 110 | 170 | |
| Turn-Off Fall Time | | t_f | -- | 70 | 110 | |

Notes:

a. pulse test: PW $\leq 300\mu s$, duty cycle $\leq 2\%$

b. For DESIGN AID ONLY, not subject to production testing.

c. Switching time is essentially independent of operating temperature.

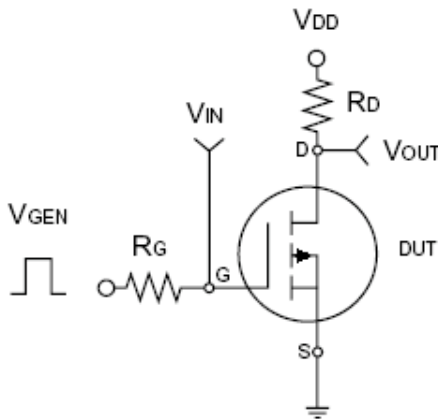

Switching Test Circuit

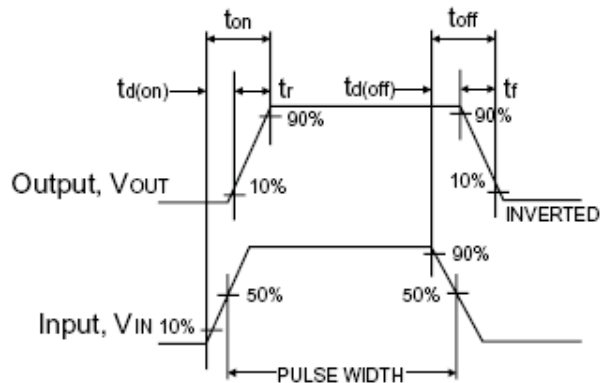

Switchin Waveforms

Electrical Characteristics Curve (Ta = 25°C, unless otherwise noted)

Output Characteristics

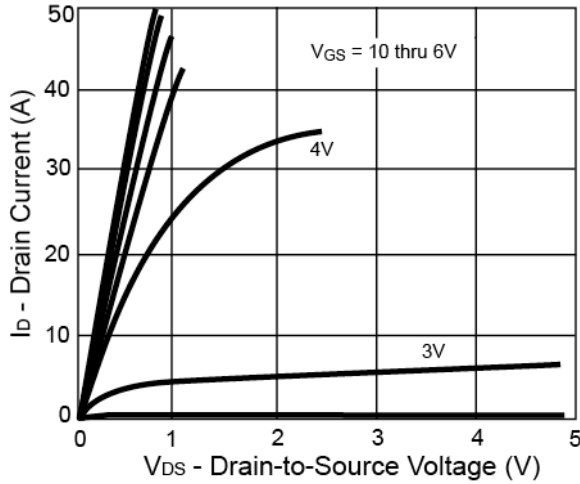

Transfer Characteristics

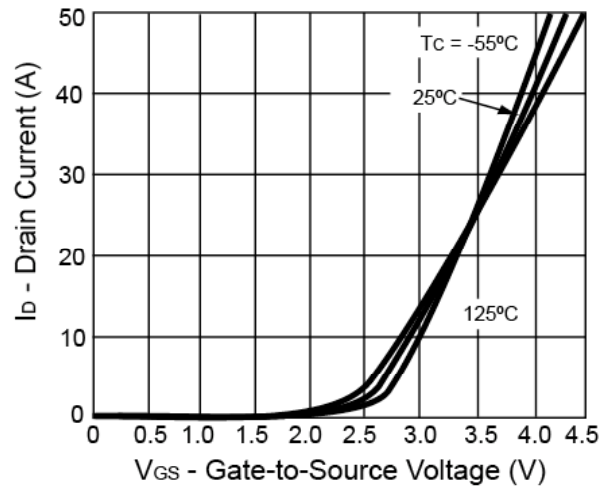

On-Resistance vs. Drain Current

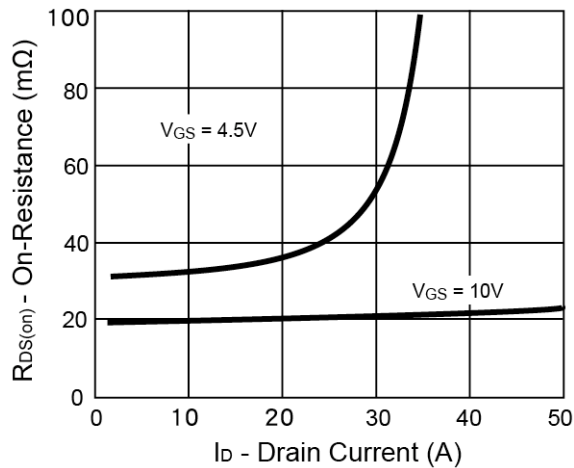

Gate Charge

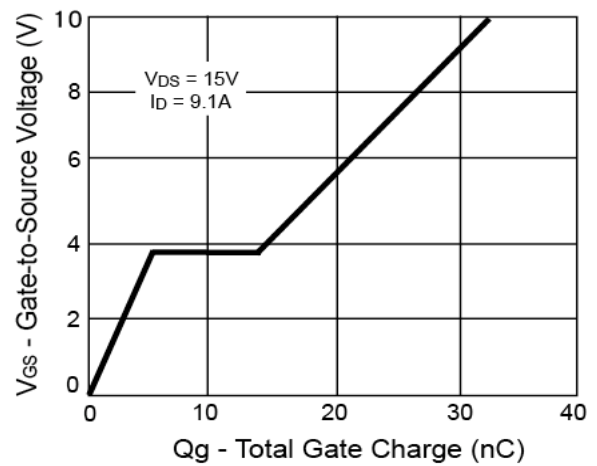

On-Resistance vs. Junction Temperature

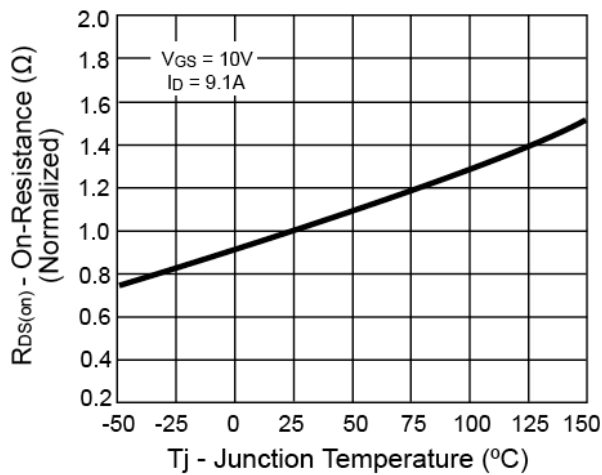

Source-Drain Diode Forward Voltage

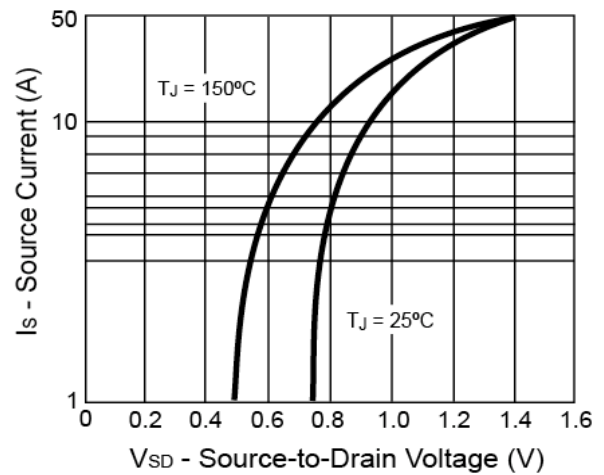

Electrical Characteristics Curve (Ta = 25°C, unless otherwise noted)

On-Resistance vs. Gate-Source Voltage

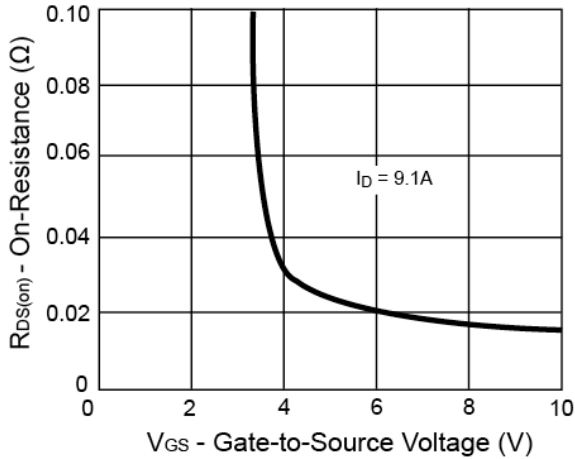

Threshold Voltage

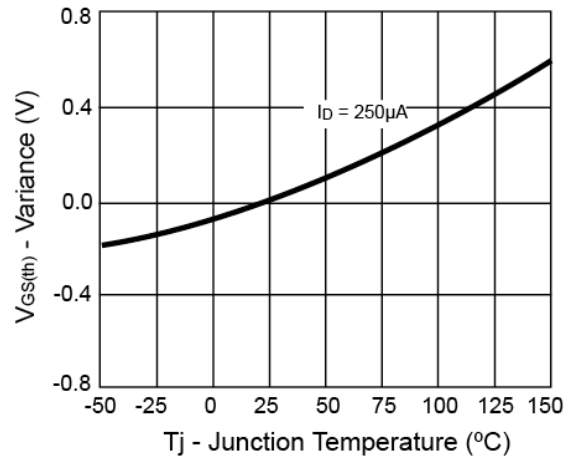

Single Pulse Power

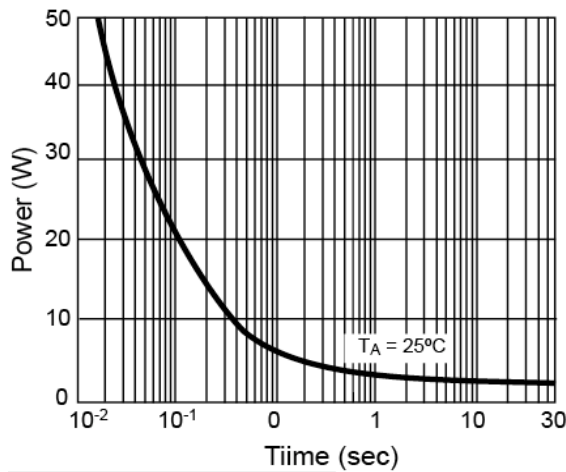

Normalized Thermal Transient Impedance, Junction-to-Ambient

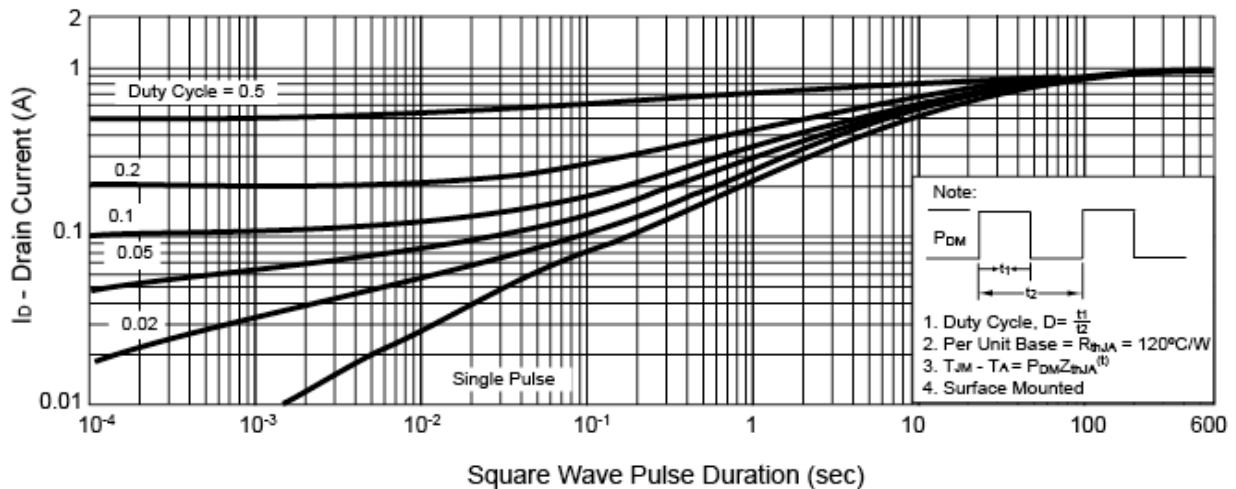

SOP-8 Mechanical Drawing

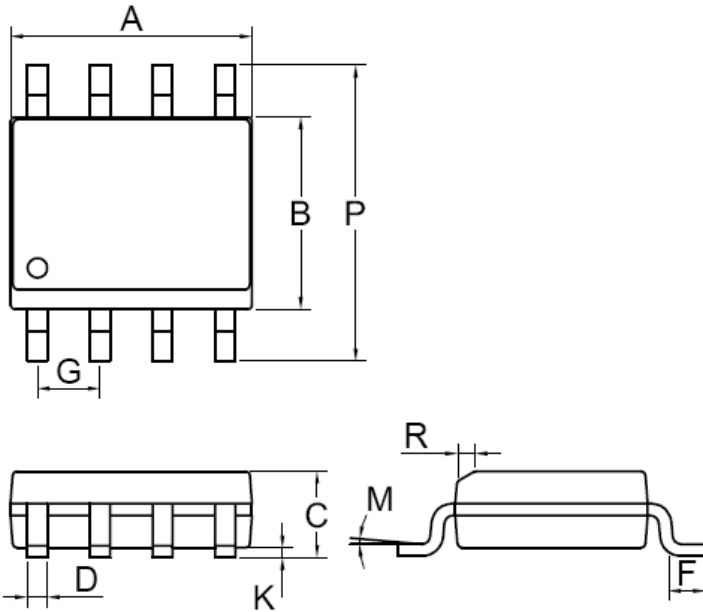

| SOP-8 DIMENSION | | | | |
|-----------------|-------------|------|---------|-------|
| DIM | MILLIMETERS | | INCHES | |
| | MIN | MAX | MIN | MAX. |
| A | 4.80 | 5.00 | 0.189 | 0.196 |
| B | 3.80 | 4.00 | 0.150 | 0.157 |
| C | 1.35 | 1.75 | 0.054 | 0.068 |
| D | 0.35 | 0.49 | 0.014 | 0.019 |
| F | 0.40 | 1.25 | 0.016 | 0.049 |
| G | 1.27BSC | | 0.05BSC | |
| K | 0.10 | 0.25 | 0.004 | 0.009 |
| M | 0° | 7° | 0° | 7° |
| P | 5.80 | 6.20 | 0.229 | 0.244 |
| R | 0.25 | 0.50 | 0.010 | 0.019 |

Marking Diagram

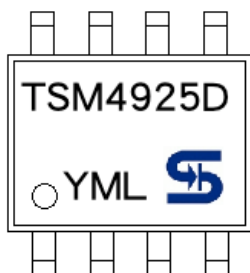

- Y** = Year Code
- M** = Month Code
(A=Jan, B=Feb, C=Mar, D=Apl, E=May, F=Jun, G=Jul, H=Aug, I=Sep, J=Oct, K=Nov, L=Dec)
- L** = Lot Code

Notice

Specifications of the products displayed herein are subject to change without notice. TSC or anyone on its behalf, assumes no responsibility or liability for any errors or inaccuracies.

Information contained herein is intended to provide a product description only. No license, express or implied, to any intellectual property rights is granted by this document. Except as provided in TSC's terms and conditions of sale for such products, TSC assumes no liability whatsoever, and disclaims any express or implied warranty, relating to sale and/or use of TSC products including liability or warranties relating to fitness for a particular purpose, merchantability, or infringement of any patent, copyright, or other intellectual property right.

The products shown herein are not designed for use in medical, life-saving, or life-sustaining applications. Customers using or selling these products for use in such applications do so at their own risk and agree to fully indemnify TSC for any damages resulting from such improper use or sale.



Компания «ЭлектроПласт» предлагает заключение долгосрочных отношений при поставках импортных электронных компонентов на взаимовыгодных условиях!

Наши преимущества:

- Оперативные поставки широкого спектра электронных компонентов отечественного и импортного производства напрямую от производителей и с крупнейших мировых складов;
- Поставка более 17-ти миллионов наименований электронных компонентов;
- Поставка сложных, дефицитных, либо снятых с производства позиций;
- Оперативные сроки поставки под заказ (от 5 рабочих дней);
- Экспресс доставка в любую точку России;
- Техническая поддержка проекта, помощь в подборе аналогов, поставка прототипов;
- Система менеджмента качества сертифицирована по Международному стандарту ISO 9001;
- Лицензия ФСБ на осуществление работ с использованием сведений, составляющих государственную тайну;
- Поставка специализированных компонентов (Xilinx, Altera, Analog Devices, Intersil, Interpoint, Microsemi, Aeroflex, Peregrine, Syfer, Eurofarad, Texas Instrument, Miteq, Cobham, E2V, MA-COM, Hittite, Mini-Circuits, General Dynamics и др.);

Помимо этого, одним из направлений компании «ЭлектроПласт» является направление «Источники питания». Мы предлагаем Вам помощь Конструкторского отдела:

- Подбор оптимального решения, техническое обоснование при выборе компонента;
- Подбор аналогов;
- Консультации по применению компонента;
- Поставка образцов и прототипов;
- Техническая поддержка проекта;
- Защита от снятия компонента с производства.



Как с нами связаться

Телефон: 8 (812) 309 58 32 (многоканальный)

Факс: 8 (812) 320-02-42

Электронная почта: org@eplast1.ru

Адрес: 198099, г. Санкт-Петербург, ул. Калинина, дом 2, корпус 4, литера А.