

## General Description

The MAX9278/MAX9282 gigabit multimedia serial link (GMSL) deserializers receive data from a GMSL serializer over 50Ω coax or 100Ω shielded twisted-pair (STP) cable and output deserialized data on 3 of 4 data-lane LVDS outputs (oLDI).

The MAX9282 has HDCP content protection but otherwise is the same as the MAX9278. The deserializers pair with any GMSL serializer capable of coax output. When programmed for STP input, they are backward compatible with any GMSL serializer.

The audio channel supports L-PCM I<sup>2</sup>S stereo and up to eight channels of L-PCM in TDM mode. Sample rates of 32kHz to 192kHz are supported with sample depth up to 32 bits.

The embedded control channel operates at 9.6kbps to 1Mbps in UART-to-UART and UART-to-I<sup>2</sup>C modes, and up to 1Mbps in I<sup>2</sup>C-to-I<sup>2</sup>C mode. Using the control channel, a μC can program serializer, deserializer, and peripheral device registers at any time, independent of video timing, and manage HDCP operation (MAX9282). Two GPIO ports are included, allowing display power-up and switching of the backlight among other uses. A continuously sampled GPI input supports touch-screen controller interrupt requests in display applications.

For use with longer cables, the deserializers have a programmable cable equalizer. Programmable spread spectrum is available on the LVDS output. The serial input and LVDS output meet ISO 10605 and IEC 61000-4-2 ESD standards. The core supply is 3.0V to 3.6V and the I/O supply is 1.7V to 3.6V.

The devices are in lead-free, 48-pin, 7mm x 7mm TQFN and QFND packages with exposed pad and 0.5mm lead pitch.

## Applications

- High-Resolution Automotive Navigation
- Rear-Seat Infotainment
- Megapixel Camera Systems

## Simplified Diagram



## Benefits and Features

- Ideal for High-Definition Video Applications
  - 104MHz High-Bandwidth Mode Supports 1920 x 720p/60Hz Display with 24-Bit Color
  - Works with Low-Cost 50Ω Coax Cable and FAKRA Connectors or 100Ω STP
  - Equalization Allows 15m Cable at Full Speed
  - Up to 192kHz Sample Rate and 32-Bit Sample Depth for 7.1 Channel HD Audio
  - Audio Clock from Audio Source or Audio Sink
  - Color Lookup Table for Gamma Correction
  - CNTL[3:0] Control Outputs
- Multiple Data Rates for System Flexibility
  - Up to 3.12Gbps Serial-Bit Rate
  - 6.25MHz to 104MHz Pixel Clock
  - 9.6kbps to 1Mbps Control Channel in UART, UART-to-UART, UART-to-I<sup>2</sup>C, or I<sup>2</sup>C-to-I<sup>2</sup>C Modes with Clock Stretch Capability
- Reduces EMI and Shielding Requirements
  - Programmable Spread Spectrum Reduces EMI
  - Tracks Spread Spectrum on Input
  - High-Immunity Mode for Maximum Control-Channel Noise Rejection
- Peripheral Features for System Power-Up and Verification
  - Built-In PRBS Tester for BER Testing of the Serial Link
  - Programmable Choice of Nine Default Device Addresses
  - Two Dedicated GPIO Ports
  - Dedicated “Up/Down” GPI for Touch-Screen Interrupt and Other Uses
  - Remote/Local Wake-Up from Sleep Mode
- Meets Rigorous Automotive and Industrial Requirements
  - -40°C to +105°C Operating Temperature
  - ±8kV Contact and ±15kV Air ISO 10605 and IEC 61000-4-2 ESD Protection

*Ordering Information appears at end of data sheet.*

Functional Diagram



---

**TABLE OF CONTENTS**

---

General Description . . . . .	1
Applications . . . . .	1
Benefits and Features . . . . .	1
Functional Diagram . . . . .	2
Absolute Maximum Ratings . . . . .	8
Package Thermal Characteristics . . . . .	8
DC Electrical Characteristics . . . . .	8
AC Electrical Characteristics . . . . .	12
Typical Operating Characteristics . . . . .	16
Pin Configuration . . . . .	18
Pin Description . . . . .	18
Detailed Description . . . . .	26
Register Mapping . . . . .	26
Output Bit Map . . . . .	27
Serial Link Signaling and Data Format . . . . .	27
High-Bandwidth Mode . . . . .	31
Audio Channel . . . . .	31
Audio Channel Input . . . . .	31
Audio Channel Output . . . . .	34
Additional MCLK Output for Audio Applications . . . . .	35
Audio Output Timing Sources . . . . .	35
Reverse Control Channel . . . . .	35
Control Channel and Register Programming . . . . .	36
UART Interface . . . . .	36
Interfacing Command-Byte-Only I <sup>2</sup> C Devices with UART . . . . .	38
UART Bypass Mode . . . . .	38
I <sup>2</sup> C Interface . . . . .	39
START and STOP Conditions . . . . .	39
Bit Transfer . . . . .	39
Acknowledge . . . . .	40
Slave Address . . . . .	40
Bus Reset . . . . .	40
Format for Writing . . . . .	41
Format for Reading . . . . .	42
I <sup>2</sup> C Communication with Remote-Side Devices . . . . .	42
I <sup>2</sup> C Address Translation . . . . .	42
GPO/GPI Control . . . . .	43
Line Equalizer . . . . .	43

**TABLE OF CONTENTS (continued)**

Spread Spectrum . . . . .	43
Manual Programming of the Spread-Spectrum Divider . . . . .	43
HS/VS/DE Tracking . . . . .	44
Serial Input . . . . .	44
Coax Splitter Mode . . . . .	44
Cable Type Configuration Input . . . . .	44
Color Lookup Tables . . . . .	45
Programming and Verifying LUT Data . . . . .	45
LUT Color Translation . . . . .	45
LUT Bit Width . . . . .	45
Recommended LUT Program Procedure . . . . .	46
High-Immunity Reverse Control-Channel Mode . . . . .	47
Sleep Mode . . . . .	47
Power-Down Mode . . . . .	47
Configuration Link . . . . .	47
Link Startup Procedure . . . . .	48
High-Bandwidth Digital Content Protection (HDCP) . . . . .	51
Encryption Enable . . . . .	51
Synchronization of Encryption . . . . .	51
Repeater Support . . . . .	51
HDCP Authentication Procedures . . . . .	52
HDCP Protocol Summary . . . . .	52
Example Repeater Network—Two $\mu$ Cs . . . . .	56
Detection and Action Upon New Device Connection . . . . .	59
Notification of Start of Authentication and Enable of Encryption to Downstream Links . . . . .	59
Applications Information . . . . .	60
Self PRBS Test . . . . .	60
Error Checking . . . . .	60
$\overline{\text{ERR}}$ Output . . . . .	60
Auto Error Reset . . . . .	60
Dual $\mu$ C Control . . . . .	60
Changing the Clock Frequency . . . . .	60
Fast Detection of Loss of Synchronization . . . . .	61
Providing a Frame Sync (Camera Applications) . . . . .	61
Software Programming of the Device Addresses . . . . .	61
3-Level Configuration Inputs . . . . .	61
Configuration Blocking . . . . .	61

**TABLE OF CONTENTS (continued)**

Compatibility with Other GMSL Devices . . . . .	61
Key Memory . . . . .	61
HS/VS/DE Inversion . . . . .	61
WS/SCK Inversion . . . . .	62
GPIOs . . . . .	62
Internal Input Pulldowns . . . . .	62
Choosing I <sup>2</sup> C/UART Pullup Resistors . . . . .	62
AC-Coupling . . . . .	62
Selection of AC-Coupling Capacitors . . . . .	62
Power-Supply Circuits and Bypassing . . . . .	63
Power-Supply Table . . . . .	63
Cables and Connectors . . . . .	63
Board Layout . . . . .	63
ESD Protection . . . . .	64
Typical Application Circuit . . . . .	74
Ordering Information . . . . .	74
Chip Information . . . . .	74
Package Information . . . . .	74
Revision History . . . . .	75

**LIST OF FIGURES**

Figure 1. Reverse Control-Channel Output Parameters . . . . .	21
Figure 2. Test Circuit for Differential Input Measurement . . . . .	21
Figure 3. Test Circuit for Single-Ended Input Measurement . . . . .	21
Figure 4. LVDS Output Parameters . . . . .	22
Figure 5. Worst-Case Pattern Output . . . . .	22
Figure 6. I <sup>2</sup> C Timing Parameters . . . . .	23
Figure 7. Parallel Clock Output Requirements . . . . .	23
Figure 8. Output Pulse Positions . . . . .	24
Figure 9. Enable and Disable Time Test Circuit . . . . .	24
Figure 10. LVDS Enable and Disable Time . . . . .	24
Figure 11. Deserializer Delay . . . . .	25
Figure 12. GPI-to-GPO Delay . . . . .	25
Figure 13. Lock Time . . . . .	26

**LIST OF FIGURES (continued)**

Figure 14. Power-Up Delay . . . . .	26
Figure 15. Output I <sup>2</sup> S Timing Parameters . . . . .	26
Figure 16. LVDS Input Timing . . . . .	28
Figure 17. LVDS Clock and Bit Assignment . . . . .	29
Figure 18. 24-Bit Mode Serial-Data Format . . . . .	29
Figure 19. 32-Bit Mode Serial-Data Format . . . . .	30
Figure 20. High-Bandwidth Mode Serial-Data Format . . . . .	30
Figure 21. Audio Channel Input Format . . . . .	31
Figure 22. 8-Channel TDM (24-Bit Samples, Padded with Zeros) . . . . .	33
Figure 23. 6-Channel TDM (24-Bit Samples, No Padding) . . . . .	33
Figure 24. Stereo I <sup>2</sup> S (24-Bit Samples, Padded with Zeros) . . . . .	33
Figure 25. Stereo I <sup>2</sup> S (16-Bit Samples, No Padding) . . . . .	34
Figure 26. Audio Channel Output Format . . . . .	34
Figure 27. GMSL UART Protocol for Base Mode . . . . .	36
Figure 28. GMSL UART Data Format for Base Mode . . . . .	37
Figure 29. Sync Byte (0x79) . . . . .	37
Figure 30. ACK Byte (0xC3) . . . . .	37
Figure 31. Format Conversion Between GMSL UART and I <sup>2</sup> C with Register Address (I2CMETHOD = 0) . . . . .	37
Figure 32. Format Conversion Between GMSL UART and I <sup>2</sup> C with Register Address (I2CMETHOD = 1) . . . . .	38
Figure 33. START and STOP Conditions . . . . .	39
Figure 34. Bit Transfer . . . . .	39
Figure 35. Acknowledge . . . . .	40
Figure 36. Slave Address . . . . .	40
Figure 37. Format for I <sup>2</sup> C Write . . . . .	41
Figure 38. Format for Write to Multiple Registers . . . . .	41
Figure 39. Format for I <sup>2</sup> C Read . . . . .	42
Figure 40. 2:1 Coax Splitter Connection Diagram . . . . .	44
Figure 41. Coax Connection Diagram . . . . .	44
Figure 42. LUT Dataflow . . . . .	46
Figure 43. State Diagram, CDS = Low (Display Application) . . . . .	49
Figure 44. State Diagram, CDS = High (Camera Application) . . . . .	50
Figure 45. Example Network with One Repeater and Two $\mu$ Cs (Tx = GMSL Serializer's, Rx = Deserializer's) . . . . .	56
Figure 46. Human Body Model ESD Test Circuit . . . . .	64
Figure 47. IEC 61000-4-2 Contact Discharge ESD Test Circuit . . . . .	64
Figure 48. ISO 10605 Contact Discharge ESD Test Circuit . . . . .	64

**LIST OF TABLES**

Table 1. Device Address Defaults (Register 0x00, 0x01) . . . . .	27
Table 2. Output Map (See <a href="#">Figure 16</a> and <a href="#">Figure 17</a> ) . . . . .	28
Table 3. Data-Rate Selection Table . . . . .	31
Table 4. Maximum Audio WS Frequency (kHz) for Various TXCLKOUT Frequencies . . . . .	32
Table 5. fSRC Settings . . . . .	35
Table 6. I <sup>2</sup> C Bit Rate Ranges . . . . .	42
Table 7. Cable Equalizer Boost Levels. . . . .	43
Table 8. Output Spread . . . . .	43
Table 9. Modulation Coefficients and Maximum SDIV Settings . . . . .	43
Table 10. Configuration Input Map. . . . .	44
Table 11. Pixel Data Format. . . . .	45
Table 12. Reverse Control-Channel Modes. . . . .	47
Table 13. Fast High-Immunity Mode Requirements. . . . .	47
Table 14. Startup Procedure for Video-Display Applications (CDS = Low). . . . .	48
Table 15. Startup Procedure for Image-Sensing Applications (CDS = High) . . . . .	50
Table 16. Startup, HDCP Authentication, and Normal Operation (Deserializer is Not a Repeater) —First Part of the HDCP Authentication Protocol . . . . .	52
Table 17. Link Integrity Check (Normal)—Performed Every 128 Frames After Encryption is Enabled . . . . .	54
Table 18. Optional Enhanced Link Integrity Check—Performed Every 16 Frames After Encryption is Enabled . . . . .	55
Table 19. HDCP Authentication and Normal Operation (One Repeater, Two $\mu$ Cs) —First and Second Parts of the HDCP Authentication Protocol . . . . .	56
Table 20. MAX9278/MAX9282 Feature Compatibility . . . . .	61
Table 21. Additional Supply Current from HDCP (MAX9282 Only) . . . . .	63
Table 22. Suggested Connectors and Cables for GMSL . . . . .	63
Table 23. Register Table . . . . .	65
Table 24. HDCP Register Table (MAX9282 Only) . . . . .	72

**Absolute Maximum Ratings (Note 1)**

AVDD to EP .....-0.5V to +3.9V  
 DVDD to EP .....-0.5V to +3.9V  
 IOVDD to EP .....-0.5V to +3.9V  
 IN+, IN- to EP .....-0.5V to +1.9V  
 TXOUT\_, TCLKOUT\_ to EP.....-0.5V to +3.9V  
 All Other Pins to EP .....-0.5V to (V<sub>IOVDD</sub> + 0.5V)  
 IN+, IN- Short Circuit to Ground or Supply ..... Continuous

Continuous Power Dissipation (T<sub>A</sub> = +70°C)  
 TQFN (derate 47.6mW/°C above +70°C).....3200mW  
 QFND (derate 38.5mW/°C above +70°C).....3076.9mW  
 Operating Temperature Range..... -40°C to +105°C  
 Junction Temperature.....+150°C  
 Storage Temperature Range..... -65°C to +150°C  
 Lead Temperature (soldering, 10s) .....+300°C  
 Soldering Temperature (reflow).....+260°C

**Note 1:** EP connected to PCB ground.

*Stresses beyond those listed under "Absolute Maximum Ratings" may cause permanent damage to the device. These are stress ratings only, and functional operation of the device at these or any other conditions beyond those indicated in the operational sections of the specifications is not implied. Exposure to absolute maximum rating conditions for extended periods may affect device reliability.*

**Package Thermal Characteristics (Note 2)**

TQFN	Junction-to-Ambient Thermal Resistance (θ <sub>JA</sub> ) .....25°C/W	QFND	Junction-to-Ambient Thermal Resistance (θ <sub>JA</sub> ) .....26°C/W
	Junction-to-Case Thermal Resistance (θ <sub>JC</sub> ).....1°C/W		Junction-to-Case Thermal Resistance (θ <sub>JC</sub> ).....1°C/W

**Note 2:** Package thermal resistances were obtained using the method described in JEDEC specification JESD51-7, using a four-layer board. For detailed information on package thermal considerations, refer to [www.maximintegrated.com/thermal-tutorial](http://www.maximintegrated.com/thermal-tutorial).

**DC Electrical Characteristics**

(V<sub>AVDD</sub> = V<sub>DVDD</sub> = 3.0V to 3.6V, V<sub>IOVDD</sub> = 1.7V to 3.6V, R<sub>L</sub> = 100Ω ±1% (differential), EP connected to PCB ground (GND), T<sub>A</sub> = -40°C to +105°C, unless otherwise noted. Typical values are at V<sub>AVDD</sub> = V<sub>DVDD</sub> = V<sub>IOVDD</sub> = 3.3V, T<sub>A</sub> = +25°C.) (Note 3)

PARAMETER	SYMBOL	CONDITIONS		MIN	TYP	MAX	UNITS
<b>SINGLE-ENDED INPUTS (GPI, CDS, HIM, EQS, PWDN, OEN, I2CSEL, MS, SSEN, DRS, WS, SCK)</b>							
High-Level Input Voltage	V <sub>IH1</sub>			0.65 x V <sub>IOVDD</sub>			V
Low-Level Input Voltage	V <sub>IL1</sub>				0.35 x V <sub>IOVDD</sub>		V
Input Current	I <sub>IN1</sub>	V <sub>IN</sub> = 0V to V <sub>IOVDD</sub>		-10		+20	μA
<b>SINGLE-ENDED OUTPUTS (MCLK, WS, SCK, SD, CNTL_, INTOUT)</b>							
High-Level Output Voltage	V <sub>OH1</sub>	I <sub>OUT</sub> = -2mA	DCS = 0	V <sub>IOVDD</sub> - 0.3			V
			DCS = 1	V <sub>IOVDD</sub> - 0.2			
Low-Level Output Voltage	V <sub>OL1</sub>	I <sub>OUT</sub> = 2mA	DCS = 0		0.3		V
			DCS = 1		0.2		
Output Short-Circuit Current	I <sub>OS</sub>	V <sub>O</sub> = 0V, DCS = 0	V <sub>IOVDD</sub> = 3.0V to 3.6V	15	25	39	mA
			V <sub>IOVDD</sub> = 1.7V to 1.9V	3	7	13	
			V <sub>IOVDD</sub> = 3.0V to 3.6V	20	35	63	
			V <sub>IOVDD</sub> = 1.7V to 1.9V	5	10	21	



**DC Electrical Characteristics (continued)**

( $V_{AVDD} = V_{DVDD} = 3.0V$  to  $3.6V$ ,  $V_{IOVDD} = 1.7V$  to  $3.6V$ ,  $R_L = 100\Omega \pm 1\%$  (differential), EP connected to PCB ground (GND),  $T_A = -40^\circ C$  to  $+105^\circ C$ , unless otherwise noted. Typical values are at  $V_{AVDD} = V_{DVDD} = V_{IOVDD} = 3.3V$ ,  $T_A = +25^\circ C$ .) (Note 3)

PARAMETER	SYMBOL	CONDITIONS		MIN	TYP	MAX	UNITS
<b>OPEN-DRAIN INPUT/OUTPUT (GPIO0, GPIO1, RX/SDA, TX/SCL, ERR, LOCK)</b>							
High-Level Input Voltage	$V_{IH2}$			0.7 x $V_{IOVDD}$			V
Low-Level Input Voltage	$V_{IL2}$					0.3 x $V_{IOVDD}$	V
Input Current	$I_{IN2}$	(Note 4)	RX/SDA, TX/SCL	-100		+5	$\mu A$
			LOCK, ERR, GPIO_	-80		+5	
Low-Level Output Voltage	$V_{OL2}$	$I_{OUT} = 3mA$	$V_{IOVDD} = 1.7V$ to $1.9V$			0.4	V
			$V_{IOVDD} = 3.0V$ to $3.6V$			0.3	
Input Capacitance	$C_{IN}$	Each pin (Note 5)				10	pF
<b>OUTPUT FOR REVERSE CONTROL CHANNEL (IN+, IN-)</b>							
Differential High Output Peak Voltage ( $V_{IN+}$ ) - ( $V_{IN-}$ )	$V_{RODH}$	Forward channel disabled, Figure 1	Legacy reverse control-channel mode	30		60	mV
			High immunity mode	50		100	
Differential Low Output Peak Voltage ( $V_{IN+}$ ) - ( $V_{IN-}$ )	$V_{RODL}$	Forward channel disabled, Figure 1	Legacy reverse control-channel mode	-60		-30	mV
			High immunity mode	-100		-50	
Single-Ended High Output Peak Voltage	$V_{ROSH}$	Forward channel disabled	Legacy reverse control-channel mode	30		60	mV
			High immunity mode	50		100	
Single-Ended Low Output Peak Voltage	$V_{ROSL}$	Forward channel disabled	Legacy reverse control-channel mode	-60		-30	mV
			High immunity mode	-100		-50	
<b>DIFFERENTIAL INPUTS (IN+, IN-)</b>							
Differential High Input Threshold (Peak) Voltage ( $V_{IN+}$ ) - ( $V_{IN-}$ )	$V_{IDH(P)}$	Figure 2	Activity detector medium threshold, (0x0B D[6:5] = 01)			60	mV
			Activity detector low threshold, (0x0B D[6:5] = 00)			47.5	
Differential Low Input Threshold (Peak) Voltage ( $V_{IN+}$ ) - ( $V_{IN-}$ )	$V_{IDL(P)}$	Figure 2	Activity detector medium threshold, (0x0B D[6:5] = 01)	-60			mV
			Activity detector medium threshold, (0x0B D[6:5] = 00)	-47.5			
Input Common-Mode Voltage ( $(V_{IN+}) + (V_{IN-})/2$ )	$V_{CMR}$			1	1.3	1.6	V

**DC Electrical Characteristics (continued)**

( $V_{AVDD} = V_{DVDD} = 3.0V$  to  $3.6V$ ,  $V_{IOVDD} = 1.7V$  to  $3.6V$ ,  $R_L = 100\Omega \pm 1\%$  (differential), EP connected to PCB ground (GND),  $T_A = -40^\circ C$  to  $+105^\circ C$ , unless otherwise noted. Typical values are at  $V_{AVDD} = V_{DVDD} = V_{IOVDD} = 3.3V$ ,  $T_A = +25^\circ C$ .) (Note 3)

PARAMETER	SYMBOL	CONDITIONS	MIN	TYP	MAX	UNITS
Differential Input Resistance (Internal)	$R_{IN}$		80	100	130	$\Omega$
<b>SINGLE-ENDED INPUTS (IN+, IN-)</b>						
Single-Ended High Input Threshold (Peak) Voltage	$V_{ISH(P)}$	Activity detector medium threshold, (0x0B D[6:5] = 01)			43	mV
		Activity detector low threshold, (0x0B D[6:5] = 00)			33	
Single-Ended Low Input Threshold (Peak) Voltage	$V_{ISL(P)}$	Activity detector medium threshold, (0x0B D[6:5] = 01)	-43			mV
		Activity detector medium threshold, (0x0B D[6:5] = 00)	-33			
Input Resistance (Internal)	$R_I$		40	50	65	$\Omega$
<b>THREE-LEVEL LOGIC INPUTS (BWS, ADD_, CX/TP)</b>						
High-Level Input Voltage	$V_{IH}$		0.7 x $V_{IOVDD}$			V
Low-Level Input Voltage	$V_{IL}$			0.3 x $V_{IOVDD}$		V
Mid-Level Input Current	$I_{INM}$	(Note 6)	-10		10	$\mu A$
Input Current	$I_{IN}$		-150		150	$\mu A$
<b>LVDS OUTPUTS (TXOUT_, TXCLKOUT_ (Figure 4))</b>						
Differential Output Voltage	$V_{OD}$		250		450	mV
Change in $V_{OS}$ Between Complementary Output States	$\Delta V_{OD}$				25	mV
Output Offset Voltage	$V_{OS}$		1.125		1.375	V
Cange in $V_{OS}$ Between Complementary Output States	$\Delta V_{OS}$				25	mV
Output Short-Circuit Current	$I_{OS}$	$V_{OUT} = 0$ or $3.6V$	3.5mA LVDS output	-7.5	+7.5	mA
			7mA LVDS output	-15	+15	
Magnitude of Differential Output Short-Circuit Current	$I_{OSD}$	3.5mA LVDS output			7.5	mA
		7mA LVDS output			15	
Output High-Impedance Current	$I_{OZ}$	Power-off or $PWDN = low$ , $V_{OUT+} = 0$ or $3.6V$ , $V_{OUT-} = 0$ or $3.6V$	-0.5		+0.5	$\mu A$

**DC Electrical Characteristics (continued)**

( $V_{AVDD} = V_{DVDD} = 3.0V$  to  $3.6V$ ,  $V_{IOVDD} = 1.7V$  to  $3.6V$ ,  $R_L = 100\Omega \pm 1\%$  (differential), EP connected to PCB ground (GND),  $T_A = -40^\circ C$  to  $+105^\circ C$ , unless otherwise noted. Typical values are at  $V_{AVDD} = V_{DVDD} = V_{IOVDD} = 3.3V$ ,  $T_A = +25^\circ C$ .) (Note 3)

PARAMETER	SYMBOL	CONDITIONS		MIN	TYP	MAX	UNITS	
<b>POWER SUPPLY</b>								
Total Supply Current (AVDD + DVDD + IOVDD) (Note 7) (Worst-Case Pattern, Figure 5)	$I_{WCS}$	BWS = low, DRS = low, $f_{TXCLKOUT} = 33.33MHz$	$I_{AVDD} + I_{DVDD}$ , 2% spread enabled or disabled	162	190		mA	
			$I_{IOVDD}$	$V_{IOVDD} = 3.6V$	9	10		
				$V_{IOVDD} = 1.9V$	4.8	5.1		
		BWS = low, DRS = low, $f_{TXCLKOUT} = 104MHz$	$I_{AVDD} + I_{DVDD}$ , 2% spread enabled or disabled	$I_{AVDD} + I_{DVDD}$ , 2% spread enabled or disabled	240	280		
				$I_{IOVDD}$	$V_{IOVDD} = 3.6V$	9		10
					$V_{IOVDD} = 1.9V$	4.8		5.1
		BWS = open, DRS = low, $f_{TXCLKOUT} = 36.66MHz$	$I_{AVDD} + I_{DVDD}$ , 2% spread enabled or disabled	$I_{AVDD} + I_{DVDD}$ , 2% spread enabled or disabled	178	210		
				$I_{IOVDD}$	$V_{IOVDD} = 3.6V$	10		11
					$V_{IOVDD} = 1.9V$	5.3		5.6
Total Supply Current (AVDD + DVDD + IOVDD) (Note 7) (Worst-Case Pattern, Figure 5)	$I_{WCS}$	BWS = open, DRS = low, $f_{TXCLKOUT} = 104MHz$	$I_{AVDD} + I_{DVDD}$ , 2% spread enabled or disabled	258	300		mA	
			$I_{IOVDD}$	$V_{IOVDD} = 3.6V$	11.5	12.5		
				$V_{IOVDD} = 1.9V$	6.2	6.5		
		BWS = high, DRS = low, $f_{TXCLKOUT} = 33.33MHz$	$I_{AVDD} + I_{DVDD}$ , 2% spread enabled or disabled	$I_{AVDD} + I_{DVDD}$ , 2% spread enabled or disabled	175	210		
				$I_{IOVDD}$	$V_{IOVDD} = 3.6V$	10.7		11.7
					$V_{IOVDD} = 1.9V$	5.7		6
		BWS = high, DRS = low, $f_{TXCLKOUT} = 78MHz$	$I_{AVDD} + I_{DVDD}$ , 2% spread enabled or disabled	$I_{AVDD} + I_{DVDD}$ , 2% spread enabled or disabled	231	280		
				$I_{IOVDD}$	$V_{IOVDD} = 3.6V$	13		14.1
					$V_{IOVDD} = 1.9V$	7		7.4
Sleep Mode Supply Current	$I_{CCS}$			64	300		$\mu A$	
Power-Down Current	$I_{CCZ}$	PWDN = GND		27	250		$\mu A$	
<b>ESD PROTECTION</b>								
IN+, IN- (Note 8)	$V_{ESD}$	Human Body Model, $R_D = 1.5k\Omega$ , $C_S = 100pF$		±8			kV	
		IEC 61000-4-2, $R_D = 330\Omega$ , $C_S = 150pF$	Contact discharge	±10				
			Air discharge	±12				
		ISO 10605, $R_D = 2k\Omega$ , $C_S = 330pF$	Contact discharge	±8				
			Air discharge	±15				

**DC Electrical Characteristics (continued)**

( $V_{AVDD} = V_{DVDD} = 3.0V$  to  $3.6V$ ,  $V_{IOVDD} = 1.7V$  to  $3.6V$ ,  $R_L = 100\Omega \pm 1\%$  (differential), EP connected to PCB ground (GND),  $T_A = -40^\circ C$  to  $+105^\circ C$ , unless otherwise noted. Typical values are at  $V_{AVDD} = V_{DVDD} = V_{IOVDD} = 3.3V$ ,  $T_A = +25^\circ C$ .) (Note 3)

PARAMETER	SYMBOL	CONDITIONS	MIN	TYP	MAX	UNITS
TXOUT_, TXCLKOUT_	$V_{ESD}$	Human Body Model, $R_D = 1.5k\Omega$ , $C_S = 100pF$		$\pm 8$		kV
		IEC 61000-4-2, $R_D = 330\Omega$ , $C_S = 150pF$	Contact discharge	$\pm 8$		
			Air discharge	$\pm 20$		
		ISO 10605, $R_D = 2k\Omega$ , $C_S = 330pF$	Contact discharge	$\pm 8$		
Air discharge	$\pm 30$					
All Other Pins (Note 9)	$V_{ESD}$	Human Body Model, $R_D = 1.5k\Omega$ , $C_S = 100pF$		$\pm 4$		kV

**AC Electrical Characteristics**

( $V_{AVDD} = V_{DVDD} = 3.0V$  to  $3.6V$ ,  $V_{IOVDD} = 1.7V$  to  $3.6V$ ,  $R_L = 100\Omega \pm 1\%$  (differential), EP connected to PCB ground (GND),  $T_A = -40^\circ C$  to  $+105^\circ C$ , unless otherwise noted. Typical values are at  $V_{AVDD} = V_{DVDD} = V_{IOVDD} = 3.3V$ ,  $T_A = +25^\circ C$ .) (Note 10)

PARAMETER	SYMBOL	CONDITIONS	MIN	TYP	MAX	UNITS
<b>LVDS CLOCK OUTPUT (TXCLKOUT_)</b>						
Clock Frequency	$f_{TXCLKOUT\_}$	BWS = low, DRS = high	8.33		16.66	MHz
		BWS = low, DRS = low	16.66		104	
		BWS = mid, DRS = high	18.33		36.66	
		BWS = mid, DRS = low	36.66		104	
		BWS = high, DRS = high	6.25		12.5	
		BWS = high, DRS = low	12.5		78	
<b>I<sup>2</sup>C/UART PORT TIMING</b>						
I <sup>2</sup> C/UART Bit Rate			9.6		1000	kbps
Output Rise Time	$t_R$	30% to 70%, $C_L = 10pF$ to $100pF$ , $1k\Omega$ pullup to $V_{IOVDD}$	20		150	ns
Output Fall Time	$t_F$	70% to 30%, $C_L = 10pF$ to $100pF$ , $1k\Omega$ pullup to $V_{IOVDD}$	20		150	ns
<b>I<sup>2</sup>C TIMING (Figure 6)</b>						
SCL Clock Frequency	$f_{SCL}$	Low $f_{SCL}$ range: (I2CMSTBT = 010, I2CSLVSH = 10)	9.6		100	kHz
		Mid $f_{SCL}$ range: (I2CMSTBT 101, I2CSLVSH = 01)	> 100		400	
		High $f_{SCL}$ range: (I2CMSTBT = 111, I2CSLVSH = 00)	> 400		1000	
START Condition Hold Time	$t_{HD:STA}$	$f_{SCL}$ range				$\mu s$
		Low	4.0			
		Mid	0.6			
		High	0.26			

**AC Electrical Characteristics (continued)**

( $V_{AVDD} = V_{DVDD} = 3.0V$  to  $3.6V$ ,  $V_{IOVDD} = 1.7V$  to  $3.6V$ ,  $R_L = 100\Omega \pm 1\%$  (differential), EP connected to PCB ground (GND),  $T_A = -40^\circ C$  to  $+105^\circ C$ , unless otherwise noted. Typical values are at  $V_{AVDD} = V_{DVDD} = V_{IOVDD} = 3.3V$ ,  $T_A = +25^\circ C$ .) (Note 10)

PARAMETER	SYMBOL	CONDITIONS		MIN	TYP	MAX	UNITS
Low Period of SCL Clock	$t_{LOW}$	$f_{SCL}$ range	Low	4.7			$\mu s$
			Mid	1.3			
			High	0.5			
High Period of SCL Clock	$t_{HIGH}$	$f_{SCL}$ range	Low	4.0			$\mu s$
			Mid	0.6			
			High	0.26			
Repeated START Condition Setup Time	$t_{SU:STA}$	$f_{SCL}$ range	Low	4.7			$\mu s$
			Mid	0.6			
			High	0.26			
Data Hold Time	$t_{HD:DAT}$	$f_{SCL}$ range	Low	0			$\mu s$
			Mid	0			
			High	0			
Data Setup Time	$t_{SU:DAT}$	$f_{SCL}$ range	Low	250			$\mu s$
			Mid	100			
			High	50			
Setup Time for STOP Condition	$t_{SU:STO}$	$f_{SCL}$ range	Low	4.0			$\mu s$
			Mid	0.6			
			High	0.26			
Bus Free Time	$t_{BUF}$	$f_{SCL}$ range	Low	4.7			$\mu s$
			Mid	1.3			
			High	0.5			
Data Valid Time	$t_{VD:DAT}$	$f_{SCL}$ range	Low		3.45		$\mu s$
			Mid		0.9		
			High		0.45		
Data Valid Acknowledge Time	$t_{VD:ACK}$	$f_{SCL}$ range	Low		3.45		$\mu s$
			Mid		0.9		
			High		0.45		
Pulse Width of Spikes Suppressed	$t_{SP}$	$f_{SCL}$ range	Low		50		ns
			Mid		50		
			High		50		
Capacitive Load Each Bus Line	$C_b$					100	pF

**AC Electrical Characteristics (continued)**

( $V_{AVDD} = V_{DVDD} = 3.0V$  to  $3.6V$ ,  $V_{IOVDD} = 1.7V$  to  $3.6V$ ,  $R_L = 100\Omega \pm 1\%$  (differential), EP connected to PCB ground (GND),  $T_A = -40^\circ C$  to  $+105^\circ C$ , unless otherwise noted. Typical values are at  $V_{AVDD} = V_{DVDD} = V_{IOVDD} = 3.3V$ ,  $T_A = +25^\circ C$ .) (Note 10)

PARAMETER	SYMBOL	CONDITIONS		MIN	TYP	MAX	UNITS
<b>SWITCHING CHARACTERISTICS</b>							
CNTL3–CNL0, MCLK Output Rise-and-Fall Time (Figure 7)	$t_R, t_F$	20% to 80%, DCS = 1, $C_L = 10pF$	DCS = 1, $C_L = 10pF$	0.5		3.1	ns
			DCS = 0, $C_L = 5pF$	0.3		2.2	
		20% to 80%, DCS = 0, $C_L = 5pF$	$V_{IOVDD} = 1.7V$ to $1.9V$	0.6		3.8	
			$V_{IOVDD} = 3.0V$ to $3.6V$	0.4		2.4	
LVDS Output Rise Time	$t_R$	20% to 80%, $R_L = 100\Omega$			200	350	ps
LVDS Output Fall Time	$t_F$	80% to 20%, $R_L = 100\Omega$			200	350	ps
LVDS Output Pulse Position (Figure 8)	$t_{PPOSN}$	N = 0 to 6, $t_{CLK} = 1/$ $f_{TXCLKOUT\_}$	$f_{TXCLKOUT\_} = 6.25MHz$	$N/7 \times$ $t_{CLK -}$ 400	$N/7 \times$ $t_{CLK}$	$N/7 \times$ $t_{CLK +}$ 400	ps
			$f_{TXCLKOUT\_} = 12.5MHz$	$N/7 \times$ $t_{CLK -}$ 250	$N/7 \times$ $t_{CLK}$	$N/7 \times$ $t_{CLK +}$ 250	
			$f_{TXCLKOUT\_} = 33MHz$	$N/7 \times$ $t_{CLK -}$ 200	$N/7 \times$ $t_{CLK}$	$N/7 \times$ $t_{CLK}$ 200	
			$f_{TXCLKOUT\_} = 78MHz$	$N/7 \times$ $t_{CLK -}$ 125	$N/7 \times$ $t_{CLK}$	$N/7 \times$ $t_{CLK +}$ 125	
			$f_{TXCLKOUT\_} = 104MHz$	$N/7 \times$ $t_{CLK -}$ 100	$N/7 \times$ $t_{CLK}$	$N/7 \times$ $t_{CLK +}$ 100	
LVDS Output Enable Time	$t_{LVEN}$	From last bit of the enable UART packet to $V_{OS} = 1.25V$ (Figure 9, 10)				50	$\mu s$
LVDS Output Disable Time	$t_{LVDS}$	From last bit of the enable UART packet to $V_{OS} = 0V$ (Figure 9, 10)				50	$\mu s$
Deserializer Delay	$t_{SD}$	(Note 11) Figure 11		38		48	$t_{PCLK}$
Reverse Control-Channel Output Rise Time	$t_R$	No forward channel data transmission, Figure 1		180		400	ns
Reverse Control-Channel Output Fall Time	$t_F$	No forward channel data transmission, Figure 1		180		400	ns
GPI-to-GPO Delay	$t_{GPIO}$	Deserializer GPI to serializer GPO (cable delay not included), Figure 12				350	$\mu s$
Lock Time	$t_{LOCK}$	Figure 13				3.6	ms
Power-Up Time	$t_{PU}$	Figure 14				9.4	ms

## AC Electrical Characteristics (continued)

( $V_{AVDD} = V_{DVDD} = 3.0V$  to  $3.6V$ ,  $V_{IOVDD} = 1.7V$  to  $3.6V$ ,  $R_L = 100\Omega \pm 1\%$  (differential), EP connected to PCB ground (GND),  $T_A = -40^\circ C$  to  $+105^\circ C$ , unless otherwise noted. Typical values are at  $V_{AVDD} = V_{DVDD} = V_{IOVDD} = 3.3V$ ,  $T_A = +25^\circ C$ .) (Note 10)

PARAMETER	SYMBOL	CONDITIONS	MIN	TYP	MAX	UNITS
<b>I<sup>2</sup>S/TDM OUTPUT TIMING (Note 6)</b>						
WS Jitter	$t_{jWS}$	$t_{WS} = 1/f_{WS}$ , (cycle-to-cycle), rising-to-falling edge or falling-to-rising edge	$f_{WS} = 48kHz$ or $44.1kHz$	1.2e-3 x $t_{WS}$	1.5e-3 x $t_{WS}$	ns
			$f_{WS} = 96kHz$	1.6e-3 x $t_{WS}$	2e-3 x $t_{WS}$	
			$f_{WS} = 192kHz$	1.6e-3 x $t_{WS}$	2e-3 x $t_{WS}$	
SCK Jitter (2-Channel I <sup>2</sup> S)	$t_{jSCK1}$	$t_{SCK} = 1/f_{SCK}$ , (cycle-to-cycle), rising-to-rising edge	$n_{SCK} = 16$ bits, $f_{WS} = 48kHz$ or $44.1kHz$	13e-3 x $t_{SCK}$	16e-3 x $t_{SCK}$	ns
			$n_{SCK} = 24$ bits, $f_{WS} = 96kHz$	39e-3 x $t_{SCK}$	48e-3 x $t_{SCK}$	
			$n_{SCK} = 32$ bits, $f_{WS} = 192kHz$	0.1 x $t_{SCK}$	0.13 x $t_{SCK}$	
SCK Jitter (8-Channel TDM)	$t_{jSCK2}$	$t_{SCK} = 1/f_{SCK}$ , (cycle-to-cycle), rising-to-rising edge	$n_{SCK} = 16$ bits, $f_{WS} = 48kHz$ or $44.1kHz$	52e-3 x $t_{SCK}$	64e-3 x $t_{SCK}$	ns
			$n_{SCK} = 24$ bits, $f_{WS} = 96kHz$	156e-3 x $t_{SCK}$	192e-3 x $t_{SCK}$	
			$n_{SCK} = 32$ bits, $f_{WS} = 192kHz$	0.4 x $t_{SCK}$	0.52 x $t_{SCK}$	
Audio Skew Relative to Video	$t_{ASK}$	Video and audio synchronized		3 x $t_{WS}$	4 x $t_{WS}$	$\mu s$
SCK, SD, WS Rise-and-Fall Time	$t_R, t_F$	20% to 80%	$C_L = 10pF$ , DCS = 1	0.3	3.1	ns
			$C_L = 5pF$ , DCS = 0	0.4	3.8	
SD, WS Valid Time Before SCK (2-Channel I <sup>2</sup> S)	$t_{DVB1}$	$t_{SCK} = 1/f_{SCK}$ , Figure 15	0.20 x $t_{SCK}$	0.5 x $t_{SCK}$		ns
SD, WS Valid Time After SCK (2-Channel I <sup>2</sup> S)	$t_{DVA1}$	$t_{SCK} = 1/f_{SCK}$ , Figure 15	0.20 x $t_{SCK}$	0.5 x $t_{SCK}$		ns
SD, WS Valid Time Before SCK (8-Channel TDM)	$t_{DVB2}$	$t_{SCK} = 1/f_{SCK}$ , Figure 15	0.20 x $t_{SCK}$	0.5 x $t_{SCK}$		ns
SD, WS Valid Time After SCK (8-Channel TDM)	$t_{DVA2}$	$t_{SCK} = 1/f_{SCK}$ , Figure 15	0.20 x $t_{SCK}$	0.5 x $t_{SCK}$		ns

**Note 3:** Limits are 100% production tested at  $T_A = +25^\circ C$ . Limits over the operating temperature range are guaranteed by design and characterization, unless otherwise noted.

**Note 4:**  $I_{IN}$  MIN due to voltage drop across the internal pullup resistor.

**Note 5:** Not production tested. Guaranteed by design.

**Note 6:** To provide a mid level, leave the input open, or, if driven, put driver in high impedance. High-impedance leakage current must be less than  $\pm 10\mu A$ .

**Note 7:**  $I_{IOVDD}$  not production tested. HDCP not enabled (MAX9282 only). See [Table 21](#) for additional supply current when HDCP is enabled

**Note 8:** Specified pin to ground.

**Note 9:** Specified pin to all supply/ground.

**Note 10:** Not production tested, guaranteed by bench characterization.

**Note 11:** Measured in pixel clock bit times.  $t_{PCLK} = 1/x \times f_{TXCLKOUT\_}$ .

Typical Operating Characteristics

( $V_{AVDD} = V_{DVDD} = V_{IOVDD} = 3.3V$ ,  $T_A = +25^\circ C$ , unless otherwise noted.)

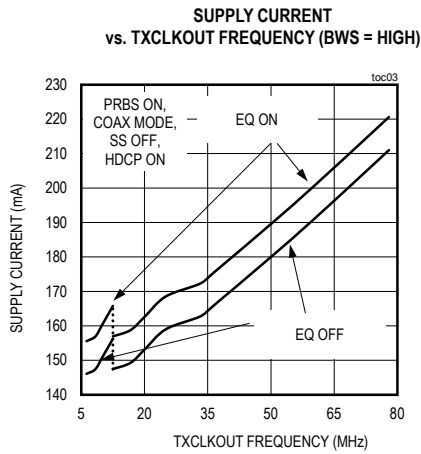



Typical Operating Characteristics (continued)

( $V_{AVDD} = V_{DVDD} = V_{IOVDD} = 3.3V$ ,  $T_A = +25^\circ C$ , unless otherwise noted.)



Pin Configuration

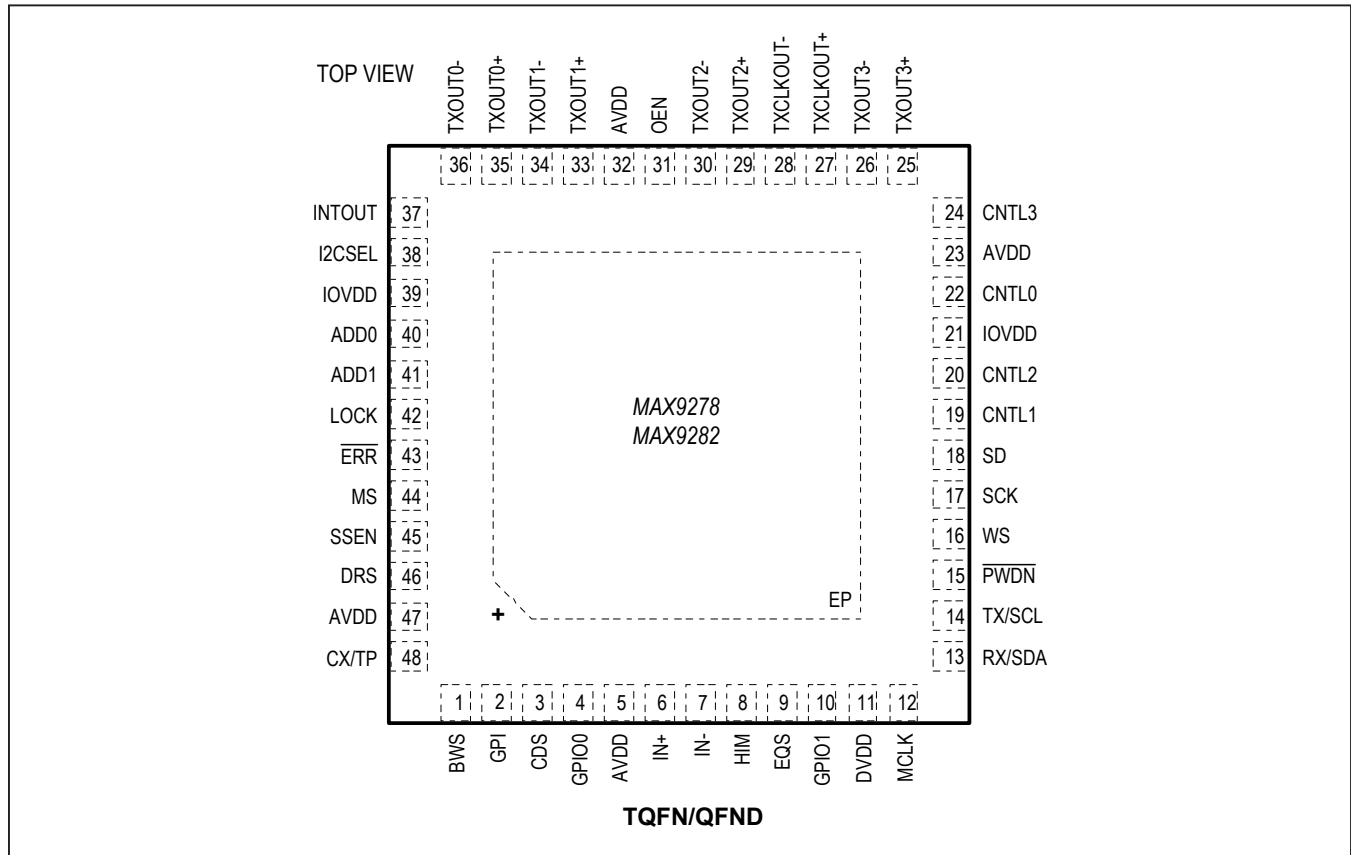

Pin Description

PIN	NAME	FUNCTION
1	BWS	Three-Level Bus Width Select Input. Set BWS to the same level on both sides of the serial link. Set BWS = low for 3-channel mode. Set BWS = high for 4-channel mode. Set BWS = open for high-bandwidth mode.
2	GPI	General-Purpose Input with Internal Pulldown to EP. The serializer GPO (or INT) output follows GPI.
3	CDS	Control Channel Direction Select Input with Internal Pulldown to EP. Set CDS = high when a control-channel master $\mu$ C is connected at the deserializer. set CDS = low when a control-channel master $\mu$ C is connected at the serializer.
4	GPIO0	Open-Drain, General-Purpose Input/Output with Internal 60k $\Omega$ Pullup to IOVDD
5, 23, 32, 47	AVDD	3.3V Analog Power Supply. Bypass AVDD to EP with 0.1 $\mu$ F and 0.001 $\mu$ F capacitors as close as possible to the device with the smaller capacitor closest to AVDD.
6	IN+	Noninverting Coax/Twisted-Pair Serial Input
7	IN-	Inverting Coax/Twisted-Pair Serial Input
8	HIM	High-Immunity Mode Input with Internal Pulldown to EP. Default HIGHIMM bit value is latched at power-up or when resuming from power-down mode (P $\overline$ WDN = low) and is active-high. HIGHIMM can be programmed to a different value after power-up. HIGHIMM in the serializer must be set to the same value.

## Pin Description (continued)

PIN	NAME	FUNCTION
9	EQS	Equalizer Select Input with Internal Pulldown to EP. The state of EQS is latched at power-up or when resuming from power-down mode ( $\overline{\text{PWDN}}$ = low). EQS = low selects 10.7dB boost. EQS = high selects 5.7dB boost.
10	GPIO1	Open-Drain, General-Purpose Input/Output with Internal 60k $\Omega$ Pullup to IOVDD
11	DVDD	3.3V Digital Power Supply. Bypass DVDD to EP with 0.1 $\mu\text{F}$ and 0.001 $\mu\text{F}$ capacitors as close as possible to the device with the smaller value capacitor closest to DVDD.
12	MCLK	Master Clock Output. See the <i>Additional MCLK Output for Audio Applications</i> section.
13	RX/SDA	UART Receive/I <sup>2</sup> C Serial-Data Input/Output with Internal 30k $\Omega$ Pullup to IOVDD. Function is determined by the state of I2CSEL at power-up. RX/SDA has an open-drain driver and requires a pullup resistor. RX: Input of the serializer's UART. SDA: Data input/output of the serializer's I <sup>2</sup> C master/slave.
14	TX/SCL	UART Transmit/I <sup>2</sup> C Serial-Clock Input/Output with Internal 30k $\Omega$ Pullup to IOVDD. Function is determined by the state of I2CSEL at power-up. TX/SCL has an open-drain driver and requires a pullup resistor. TX: Output of the serializer's UART. SCL: Clock input/output of the serializer's I <sup>2</sup> C master/slave.
15	$\overline{\text{PWDN}}$	Active-Low, Power-Down Input with Internal Pulldown to EP. Set $\overline{\text{PWDN}}$ low to enter power-down mode to reduce power consumption.
16	WS	I <sup>2</sup> S/TDM Word-Select Input/Output. Powers up as an I <sup>2</sup> S output (deserializer-provided clock). Set AUDIOMODE bit = 1 to change WS to an input with internal pulldown to GND and supply WS externally (system provided clock).
17	SCK	I <sup>2</sup> S/TDM Serial-Clock Input/Output. Powers up as an I <sup>2</sup> S output (deserializer-provided clock). Set AUDIOMODE bit = 1 to change SCK to an input with internal pulldown to GND and supply SCK externally (system provided clock).
18	SD	I <sup>2</sup> S/TDM Serial-Data Output. Disable I <sup>2</sup> S/TDM encoding to serial data to use SD as an additional control/data output valid on the selected edge of TXCLKOUT_. Encrypted when HDCP is enabled (MAX9282 only).
19	CNTL1	Auxiliary Control-Signal Output. CNTL1 remains high impedance in 24-bit mode (BWS = low) CNTL1 used only in 32-bit or high-bandwidth mode (BWS = high or open). CNTL1 not encrypted when HDCP is enabled (MAX9282 only)
20	CNTL2	Auxiliary Control-Signal Output. CNTL2 remains high impedance in 24-bit mode (BWS = low). CNTL2 used only in 32-bit or high-bandwidth mode (BWS = high or open). CNTL2 not encrypted when HDCP is enabled (MAX9282 only).
21, 39	IOVDD	I/O Supply Voltage. 1.8V to 3.3V logic I/O power supply. Bypass IOVDD to EP with 0.1 $\mu\text{F}$ and 0.001 $\mu\text{F}$ capacitors as close as possible to the device with the smallest value capacitor closest to IOVDD.
22	CNTL0	Auxiliary Control-Signal Output. CNTL0: Used only in high-bandwidth mode (BWS = open). CNTL0 not encrypted when HDCP is enabled (MAX9282 only).
24	CNTL3	Auxiliary Control-Signal Output. CNTL3: Used only in high-bandwidth mode (BWS = open). CNTL3 not encrypted when HDCP is enabled (MAX9282 only).

## Pin Description (continued)

PIN	NAME	FUNCTION
25, 26, 29, 30, 33–36	TXOUT_+, TXOUT_-	LVDS Data Output. Output use depends on BWS pin setting (Table 3). Certain data bits encrypted when HDCP is enabled (MAX9282 only).
27, 28	TXCLKOUT+, TXCLKOUT-	LVDS Clock Output
31	OEN	CMOS Output-Enable Input with Internal Pulldown to EP. Set OEN high to enable MCLK, CNTL0, CNTL3, and INTOUT. Set OEN = low to put MCLK CNTL0, CNTL3, and INTOUT into high impedance.
37	INTOUT	A/V Status Register Interrupt Output. Indicates new data in the A/V status registers. INTOUT is reset when the A/V status registers are read.
38	I2CSEL	I <sup>2</sup> C Select. Control-channel interface protocol select input with internal pulldown to EP. Set I2CSEL = high to select I <sup>2</sup> C-to-I <sup>2</sup> C interface. Set I2CSEL = low to select UART-to-UART or UART-to-I <sup>2</sup> C interface.
40	ADD0	Three-Level Address Selection Input with Internal Pulldown to EP. The state of ADD0 is latched at power-up or when resuming from power-down mode ( $\overline{\text{PWDN}}$ = low). See Table 1.
41	ADD1	Three-Level Address Selection Input with Internal Pulldown to EP. The state of ADD1 is latched at power-up or when resuming from power-down mode ( $\overline{\text{PWDN}}$ = low). See Table 1.
42	LOCK	Open-Drain Lock Output with Internal 30k $\Omega$ Pullup to IOVDD. LOCK = high indicates that PLLs are locked with correct serial-word-boundary alignment. LOCK = low indicates that PLLs are not locked or an incorrect serial-word-boundary alignment. LOCK is high when $\overline{\text{PWDN}}$ = low.
43	$\overline{\text{ERR}}$	Error Output. Open-drain data error detection and/or correction indication output with internal 30k $\Omega$ pullup to IOVDD. $\overline{\text{ERR}}$ is high when $\overline{\text{PWDN}}$ is low.
44	MS	Mode Select with Internal Pulldown to EP. MS sets the control-link mode when CDS = high. Set MS = low to select base mode. Set MS = high to select bypass mode. MS sets the power-up state when CDS = low (see Figure 41).
45	SSEN	Spread-Spectrum Enable Input with Internal Pulldown to EP (Default). The state of SSEN is latched at power-up or when resuming from power-down mode ( $\overline{\text{PWDN}}$ = low). Set SSEN = high for 2% spread spectrum on the LVDS and control outputs. Set SSEN = low to use the LVDS and control outputs without spread spectrum.
46	DRS	Data-Rate Select Input with Internal Pulldown to EP (Default). The state of DRS is latched at power-up or when resuming from power-down mode ( $\overline{\text{PWDN}}$ = low). Set DRS = high for slow TXCLKOUT_ frequencies (Table 4). Set SSEN = low for fast TXCLKOUT_ frequencies.
48	CX/TP	Three-Level Coax/Twisted-Pair Select Input. See Table 10 for function.
—	EP	Exposed Pad. EP is internally connected to device ground. <b>MUST</b> connect EP to the PCB ground plane through an array of vias for proper thermal and electrical performance.



Figure 1. Reverse Control-Channel Output Parameters



Figure 2. Test Circuit for Differential Input Measurement



Figure 3. Test Circuit for Single-Ended Input Measurement

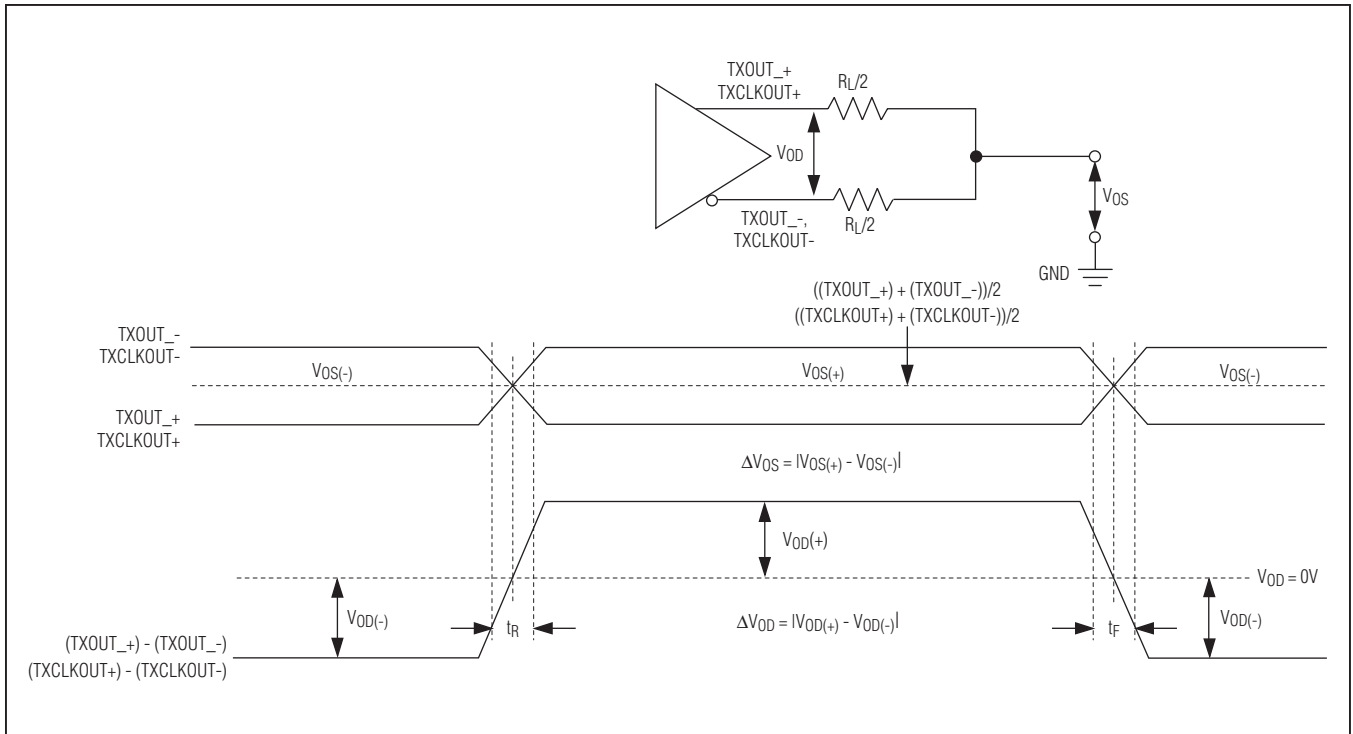

Figure 4. LVDS Output Parameters

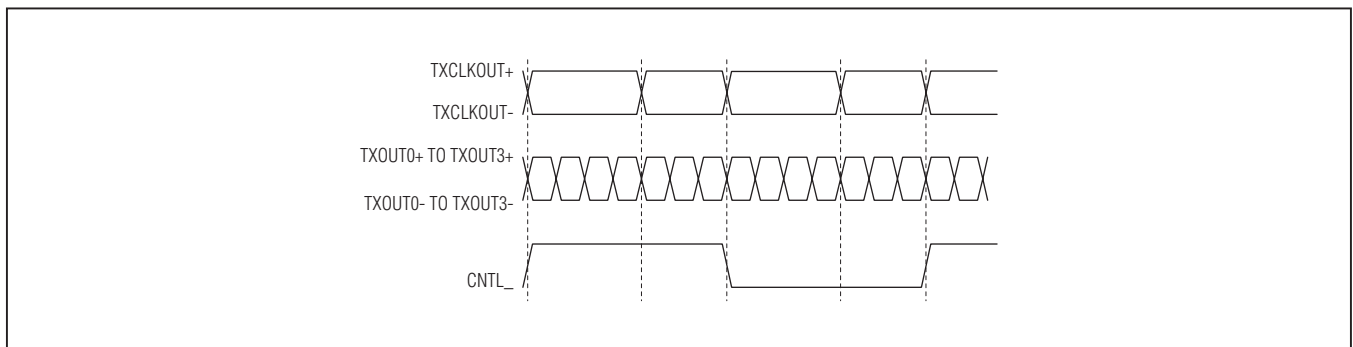

Figure 5. Worst-Case Pattern Output



Figure 6. I<sup>2</sup>C Timing Parameters



Figure 7. Parallel Clock Output Requirements



Figure 8. Output Pulse Positions



Figure 9. Enable and Disable Time Test Circuit



Figure 10. LVDS Enable and Disable Time





Figure 11. Deserializer Delay



Figure 12. GPI-to-GPO Delay



Figure 13. Lock Time



Figure 14. Power-Up Delay



Figure 15. Output I2S Timing Parameters

### Detailed Description

The MAX9278/MAX9282 deserializers, when paired with the MAX9275/MAX9277/MAX9279/MAX9281 serializers, provide the full set of operating features, but are backward compatible with the MAX9249–MAX9270 family of gigabit multimedia serial link (GMSL) devices, and have basic functionality when paired with any GMSL device. The MAX9282 has high-bandwidth digital content protection (HDCP), while the MAX9278 does not.

The deserializers have a maximum serial-bit rate of 3.12Gbps for up to 15m of cable and operates up to a maximum output clock of 104MHz in 24-bit 3-channel mode and 27-bit high-bandwidth mode, or 78MHz in 32-bit 4-channel mode. This bit rate and output flexibility support a wide range of displays, from QVGA (320 x 240) to 1920 x 720 and higher with 24-bit color, as well as megapixel image sensors. An encoded audio channel supports L-PCM I2S stereo and up to eight channels of L-PCM in TDM mode. Sample rates of 32kHz to 192kHz are supported with sample depth from 8 to 32 bits. Input equalization, combined with GMSL serializer pre/deemphasis, extends the cable length and enhances link reliability.

The control channel enables a  $\mu$ C to program the serializer and deserializer registers and program registers on peripherals. The control channel is also used to perform HDCP functions (MAX9282 only). The  $\mu$ C can be located at either end of the link, or when using two  $\mu$ Cs, at both ends. Two modes of control-channel operation are available. Base mode uses either I2C or GMSL UART protocol, while bypass mode uses a user-defined UART protocol. UART protocol allows full-duplex communication, while I2C allows half-duplex communication.

Spread spectrum is available to reduce EMI on the LVDS output. The serial input complies with ISO 10605 and IEC 61000-4-2 ESD protection standards.

### Register Mapping

Registers set the operating conditions of the deserializers and are programmed using the control channel in base mode. The MAX9278/MAX9282 holds its own device address and the device address of the serializer it is paired with. Similarly, the serializer holds its own device address and the address of the MAX9278/MAX9282. Whenever a device address is changed, be sure to write the new address to both devices. The default device address of the deserializer is set by the ADD[1:0] and CX/TP inputs (see Table 1). Registers 0x00 and 0x01 in both devices hold the device addresses.

**Table 1. Device Address Defaults (Register 0x00, 0x01)**

PIN			DEVICE ADDRESS (BIN)								SERIALIZER DEVICE ADDRESS (hex)	DESERIALIZER DEVICE ADDRESS (hex)
CX/TP**	ADD1	ADD0	D7	D6	D5	D4	D3	D2	D1	D0		
High/Low	Low	Low	1	0	0	X*	0	0	0	R $\overline{W}$	80	90
High/Low	Low	High	1	0	0	X*	0	1	0	R $\overline{W}$	84	94
High/Low	Low	Open	1	0	0	X*	1	0	0	R $\overline{W}$	88	98
High/Low	High	Low	1	1	0	X*	0	0	0	R $\overline{W}$	C0	D0
High/Low	High	High	1	1	0	X*	0	1	0	R $\overline{W}$	C4	D4
High/Low	High	Open	1	1	0	X*	1	0	0	R $\overline{W}$	C8	D8
High/Low	Open	Low	0	1	0	X*	0	0	0	R $\overline{W}$	40	50
High/Low	Open	High	0	1	0	X*	0	1	0	R $\overline{W}$	44	54
High/Low	Open	Open	0	1	0	X*	1	0	0	R $\overline{W}$	48	58
Open	Low	Low	1	0	0	X*	0	0	X*	R $\overline{W}$	80	92
Open	Low	High	1	0	0	X*	0	1	X*	R $\overline{W}$	84	96
Open	Low	Open	1	0	0	X*	1	0	X*	R $\overline{W}$	88	9A
Open	High	Low	1	1	0	X*	0	0	X*	R $\overline{W}$	C0	D2
Open	High	High	1	1	0	X*	0	1	X*	R $\overline{W}$	C4	D6
Open	High	Open	1	1	0	X*	1	0	X*	R $\overline{W}$	C8	DA
Open	Open	Low	0	1	0	X*	0	0	X*	R $\overline{W}$	40	52
Open	Open	High	0	1	0	X*	0	1	X*	R $\overline{W}$	44	56
Open	Open	Open	0	1	0	X*	1	0	X*	R $\overline{W}$	48	5A

\*X = 0 for the serializer address; X = 1 for the deserializer address.

\*\*CX/TP determine the serial cable type; CX/TP = open addresses only for coax mode.

### Output Bit Map

The output bit width depends on settings of the bus width (BWS) pin. [Table 2](#) lists the bit map. Unused output bits are pulled low.

### Serial Link Signaling and Data Format

The serializer uses differential CML signaling to drive twisted-pair cable and single-ended CML to drive coaxial cable with programmable pre/deemphasis and AC-coupling. The deserializer uses AC-coupling and programmable channel equalization.

Input data is scrambled and then 8b/10b coded (9b/10b in high-bandwidth mode). The deserializer recovers the embedded serial clock, then samples, decodes, and descrambles the data. In 3-channel mode, the first 21 bits contain video data. In 4-channel mode, the first 29 bits contain video data. In high-bandwidth mode, the first 24 bits contain video data, or special control signal packets. The last 3 bits contain the embedded audio channel, the embedded forward control channel, and the parity bit of the serial word ([Figure 18](#), [Figure 19](#), [Figure 20](#)).

**Table 2. Output Map (See Figure 16 and Figure 17)**

SIGNAL	INPUT PIN/BIT POSITION	MODE		
		3-CHANNEL MODE (BWS = LOW)	HIGH-BANDWIDTH MODE (BWS = OPEN)	4-CHANNEL MODE (BWS = HIGH)
R[5:0]	DOUT[5:0]	Used	Used	Used
G[5:0]	DOUT [11:6]	Used	Used	Used
B[5:0]	DOUT [17:12]	Used	Used	Used
HS, VS, DE	DOUT18/HS, DOUT19/VS, DOUT20/DE	Used**	Used**	Used**
R[7:6]	DOUT [22:21]	Used+	Used	Used
G[7:6]	DOUT [24:23]	Used+	Used	Used
B[7:6]	DOUT [26:25]	Used+	Used	Used
RES, CNTL[2:1]	RES, CNTL[2:1]	Not used	Used*/**	Used**
CNTL3, CNTL0	CNTL3, CNTL0	Not used	Used*/**	Not used
I <sup>2</sup> S/TDM	WS, SCK, SD	Used	Used	Used
AUX SIGNAL		Used	Used	Used

\*See the *High-Bandwidth Mode* section for details on timing requirements.

+Outputs used only when the respective color lookup tables are enabled.

\*\*Not encrypted when HDCP is enabled (MAX9282 only).



Figure 16. LVDS Input Timing



Figure 17. LVDS Clock and Bit Assignment



Figure 18. 24-Bit Mode Serial-Data Format



Figure 19. 32-Bit Mode Serial-Data Format



Figure 20. High-Bandwidth Mode Serial-Data Format

**Table 3. Data-Rate Selection Table**

DRS BIT SETTING	BWS PIN SETTING	PCLKOUT RANGE (MHz)
0 (high data rate)	Low (24-bit mode)	16.66 to 104
	Mid (high bandwidth mode)	36.66 to 104
	High (32-bit mode)	12.5 to 78
1 (low data rate)	Low	8.33 to 16.66
	Mid	18.33 to 36.66
	High	6.25 to 12.5

The deserializer uses the DRS bit and the BWS input to set the TXCLKOUT frequency range (Table 3). Set DRS = 1 for low data rate TXCLKOUT frequency range. Set DRS = 0 for high data rate TXCLKOUT frequency range.

**High-Bandwidth Mode**

The deserializer uses a 27-bit high-bandwidth mode to support 24-bit RGB at 104MHz pixel clock. Set BWS = open in both the serializer and deserializer to use high-bandwidth mode. In high-bandwidth mode, the deserializer decodes HS, VS, DE, and CNTL[3:0] from special packets. Packets are sent by replacing a pixel before the rising edge and after the falling edge of the HS, VS, and DE signals. However, for CNTL[3:0], packets always replace a pixel before the transition of CNTL[3:0]. Keep HS, VS, and DE low pulse widths at least 2 pixel clock cycles. By default, CNTL[3:0] are sampled continuously when DE is low. CNTL[3:0] are sampled only on HS/VS transitions when DE is high. If DE triggering of encoded packets is not desired, set the serializer’s DISDETRIG = 0 and the CNTLTRIG bits to their desired value (register 0x15) to change the CNTL triggering behavior. Set DETREN = 0 on the deserializer when DE is not periodic.

**Audio Channel**

The audio channel supports 8kHz to 192kHz audio sampling rates and audio word lengths from 8 bits to 32 bits (2-channel I<sup>2</sup>S) or 64 to 256 bits (TDM64 to TDM256). The audio bit clock (SCK) does not have to be synchronized with TXCLKOUT. The serializer automatically encodes audio data into a single-bit stream synchronous with TXCLKOUT. The deserializer decodes the audio stream and stores audio words in a FIFO. Audio

rate detection uses an internal oscillator to continuously determine the audio data rate and output the audio in I<sup>2</sup>S format. The audio channel is enabled by default. When the audio channel is disabled, the SD/HIM is treated as an auxiliary control signal.

Since the encoded audio data sent through the serial link is synchronized with TXCLKOUT (through ACB), low TXCLKOUT frequencies limit the maximum audio sampling rate. Table 3 lists the maximum audio sampling rate for various TXCLKOUT frequencies. Spread-spectrum settings do not affect the I<sup>2</sup>S/TDM data rate or WS clock frequency.

**Audio Channel Input**

The audio channel input works with 8-channel TDM and stereo I<sup>2</sup>S, as well as nonstandard formats. The input format is shown in Figure 21.



Figure 21. Audio Channel Input Format

**Table 4. Maximum Audio WS Frequency (kHz) for Various TXCLKOUT Frequencies**

CHANNELS	BITS PER CHANNEL	TXCLKOUT FREQUENCY (DRS = 0*) (MHz)										
		12.5	15.0	16.6	20.0	25.0	30.0	35.0	40.0	45.0	50.0	100
2	8	+	+	+	+	+	+	+	+	+	+	+
	16	+	+	+	+	+	+	+	+	+	+	+
	18	185.5	+	+	+	+	+	+	+	+	+	+
	20	174.6	+	+	+	+	+	+	+	+	+	+
	24	152.2	182.7	+	+	+	+	+	+	+	+	+
	32	123.7	148.4	164.3	+	+	+	+	+	+	+	+
4	8	+	+	+	+	+	+	+	+	+	+	+
	16	123.7	148.4	164.3	+	+	+	+	+	+	+	+
	18	112.0	134.4	148.8	179.2	+	+	+	+	+	+	+
	20	104.2	125.0	138.3	166.7	+	+	+	+	+	+	+
	24	88.6	106.3	117.7	141.8	177.2	+	+	+	+	+	+
	32	69.9	83.8	92.8	111.8	139.7	167.6	+	+	+	+	+
6	8	152.2	182.7	+	+	+	+	+	+	+	+	+
	16	88.6	106.3	117.7	141.8	177.2	+	+	+	+	+	+
	18	80.2	93.3	106.6	128.4	160.5	+	+	+	+	+	+
	20	73.3	88.0	97.3	117.3	146.6	175.9	+	+	+	+	+
	24	62.5	75.0	83.0	100	125	150	175	+	+	+	+
	32	48.3	57.9	64.1	77.2	96.5	115.9	135.2	154.5	173.8	+	+
8	8	123.7	148.4	164.3	+	+	+	+	+	+	+	+
	16	69.9	83.8	92.8	111.8	139.7	167.6	+	+	+	+	+
	18	62.5	75.0	83.0	100.0	125.0	150.0	175.0	+	+	+	+
	20	57.1	68.5	75.8	91.3	114.2	137.0	159.9	182.7	+	+	+
	24	48.3	57.9	64.1	77.2	96.5	115.9	135.2	154.5	173.8	+	+
	32	37.1	44.5	49.3	59.4	74.2	89.1	103.9	118.8	133.6	148.4	+

COLOR CODING
< 48kHz
48kHz to 96kHz
96kHz to 192kHz
> 192kHz

+Max WS rate is greater than 192kHz.

\*DRS = 0 TXCLKOUT frequency is equal to 2x the DRS = 1 TXCLKOUT frequency.



The period of the WS can be 8 to 256 SCK periods. The WS frame starts with the falling edge and can be low for 1 to 255 SCK periods. SD is one SCK period, sampled on the rising edge. MSB/LSB order, zero padding or any other significance assigned to the serial data does not

affect operation of the audio channel. The polarity for WS and SCK edges is programmable.

Figure 22, Figure 23, Figure 24, and Figure 25 are examples of acceptable input formats.



Figure 22. 8-Channel TDM (24-Bit Samples, Padded with Zeros)



Figure 23. 6-Channel TDM (24-Bit Samples, No Padding)



Figure 24. Stereo I<sup>2</sup>S (24-Bit Samples, Padded with Zeros)



Figure 25. Stereo I<sup>2</sup>S (16-Bit Samples, No Padding)

**Audio Channel Output**

WS, SCK, and SD are output with the same timing relationship they had at the audio input, except that WS is always 50% duty cycle (regardless of the duty cycle of WS at the input).

The output format is shown in [Figure 26](#).

WS and SCK can be driven by the audio source (clock master) or the audio sink (clock slave). Buffer underflow and overflow flags are available to the sink as clock slave through I<sup>2</sup>C for clock-frequency adjustment. Data are sampled on the rising edge. WS and SCK polarity are programmable.



Figure 26. Audio Channel Output Format

**Additional MCLK Output for Audio Applications**

Some audio DACs, such as the MAX9850, do not require a synchronous main clock (MCLK), while other DACs require a separate MCLK for operation. For audio applications that cannot use WS or TXCLKOUT directly, the deserializer provides a divided MCLK output at either DOUT28/CNTL2 or CNTL0/ADD0 (determined by MCLKPIN bit setting) at the expense of one less control line. By default, MCLK is turned off. Set MCLKDIV (deserializer register 0x12, D[6:0]) to a nonzero value to enable the MCLK output. Set MCLKDIV to 0x00 to disable MCLK and set DOUT28/CNTL2 or CNTL0/ADD0 as a control output.

The output MCLK frequency is:

$$f_{MCLK} = \frac{f_{SRC}}{MCLKDIV}$$

where:

$f_{SRC}$  is the MCLK source frequency (see [Table 5](#))

MCLKDIV is the divider ratio from 1 to 127

Choose MCLKDIV values so that  $f_{MCLK}$  is not greater than 60MHz. MCLK frequencies derived from TXCLKOUT (MCLKSRC = 0) are not affected by spread-spectrum settings in the deserializer. Enabling spread spectrum in the serializer, however, introduces spread spectrum into MCLK. Spread-spectrum settings of either device do not affect MCLK frequencies derived from the internal oscillator. The internal oscillator frequency ranges from 100MHz to 150MHz over all process corners and operating conditions. Alternatively, set MCLKWS = 1 (0x15 D1) to output WS from MCLK.

**Table 5.  $f_{SRC}$  Settings**

MCLKWS SETTING (REGISTER 0x15, D1)	MCLKSRC SETTING (REGISTER 0x12, D7)	DATA RATE SETTING	BIT-WIDTH SETTING	MCLK SOURCE FREQUENCY ( $f_{SRC}$ )
0	0	High speed (DRS = 0)	24-bit or high-bandwidth mode	$3 \times f_{TXCLKOUT}$
			32-bit mode	$4 \times f_{TXCLKOUT}$
	Low speed (DRS = 1)	24-bit or high-bandwidth mode	$6 \times f_{TXCLKOUT}$	
		32-bit mode	$8 \times f_{TXCLKOUT}$	
	1	—	—	Internal oscillator (120MHz typ)
1	—	—	—	WS*

\*MCLK is not divided when using WS as the MCLK source. MCLK divider must still be set to a nonzero number for MCLK to be enabled.

**Audio Output Timing Sources**

The deserializer has multiple options for audio data output timing. By default, the deserializer provides the output timing based on the incoming data rate (through a FIFO) and an internal oscillator.

To use a system-sourced clock, set the AUDIOMODE bit to 1 (D5 of register 0x02) to set WS and SCK as inputs on the deserializer side. The deserializer uses a FIFO to smooth out the differences in input and output audio timing. Registers 0x78 and 0x79 store the FIFO overflow/underflow information for use with external WS/SCK timing. The FIFO drops data packets during FIFO overflow. By default, the FIFO repeats the last audio packet during FIFO underflow when no audio data is available. Set the AUDUFBEH bit (D2 of register 0x01D) to 1 to output all zeroes during underflow.

**Reverse Control Channel**

The serializer uses the reverse control channel to receive I<sup>2</sup>C/UART and GPO signals from the deserializer in the opposite direction of the video stream. The reverse control channel and forward video data coexist on the same serial cable forming a bidirectional link. The reverse control channel operates independently from the forward control channel. The reverse control channel is available 2ms after power-up. The serializer temporarily disables the reverse control channel for 500µs after starting/stopping the forward serial link.

**Control Channel and Register Programming**

The control channel is available for the  $\mu\text{C}$  to send and receive control data over the serial link simultaneously with the high-speed data. The  $\mu\text{C}$  controls the link from either the serializer or the deserializer side to support video-display or image-sensing applications. The control channel between the  $\mu\text{C}$  and serializer or deserializer runs in base mode or bypass mode according to the mode selection (MS) input of the device connected to the  $\mu\text{C}$ . Base mode is a half-duplex control channel and the bypass mode is a full-duplex control channel. The total maximum forward or reverse control-channel delay is  $2\mu\text{s}$  (UART) or 2-bit times ( $\text{I}^2\text{C}$ ) from the input of one device to the output of the other.  $\text{I}^2\text{C}$  delay is measured from a local START condition to a remote START condition.

**UART Interface**

In base mode, the  $\mu\text{C}$  is the host and can access the registers of both the serializer and deserializer from either side of the link using the GMSL UART protocol. The  $\mu\text{C}$  can also program the peripherals on the remote side by sending the UART packets to the serializer or deserializer, with the UART packets converted to  $\text{I}^2\text{C}$  by the device on the remote side of the link. The  $\mu\text{C}$  communicates with a UART peripheral in base mode (through INTTYPE register settings), using the half-duplex default GMSL UART protocol of the serializer/deserializer. The device addresses of the serializer and deserializer in base mode are programmable.

When the peripheral interface is  $\text{I}^2\text{C}$ , the serializer/deserializer converts UART packets to  $\text{I}^2\text{C}$  that have device addresses different from those of the serializer or deserializer. The converted  $\text{I}^2\text{C}$  bit rate is the same as the original UART bit rate.

The deserializer uses differential line coding to send signals over the reverse channel to the serializer. The bit rate of the control channel is 9.6kbps to 1Mbps in both directions. The serializer and deserializer automatically detect the control-channel bit rate in base mode. Packet bit-rate changes can be made in steps of up to 3.5 times higher or lower than the previous bit rate. See the [Changing the Clock Frequency](#) section for more information.

Figure 27 shows the UART protocol for writing and reading in base mode between the  $\mu\text{C}$  and the serializer/deserializer.

Figure 28 shows the UART data format. Even parity is used. Figure 29 and Figure 30 detail the formats of the SYNC byte (0x79) and the ACK byte (0xC3). The  $\mu\text{C}$  and the connected slave chip generate the SYNC byte and ACK byte, respectively. Events such as device wake-up and GPI generate transitions on the control channel that can be ignored by the  $\mu\text{C}$ . Data written to the deserializer registers do not take effect until after the acknowledge byte is sent. This allows the  $\mu\text{C}$  to verify that write commands are received without error, even if the result of the write command directly affects the serial link. The slave uses the SYNC byte to synchronize with the host UART's data rate. If the GPI or MS inputs of the deserializer toggle while there is control-channel communication, or if a line fault occurs, the control-channel communication will be corrupted. In the event of a missed or delayed acknowledge ( $\sim 1\text{ms}$  due to control-channel timeout), the  $\mu\text{C}$  should assume there was an error in the packet transmission or response. In base mode, the  $\mu\text{C}$  must keep the UART Tx/Rx lines high no more than 4 bit times between bytes in a packet. Keep the UART Tx/Rx lines high for at least 16 bit times before starting to send a new packet.



Figure 27. GMSL UART Protocol for Base Mode



Figure 28. GMSL UART Data Format for Base Mode

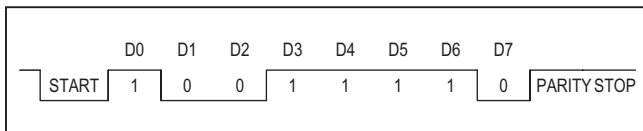

Figure 29. Sync Byte (0x79)

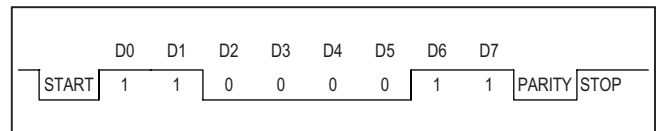

Figure 30. ACK Byte (0xC3)

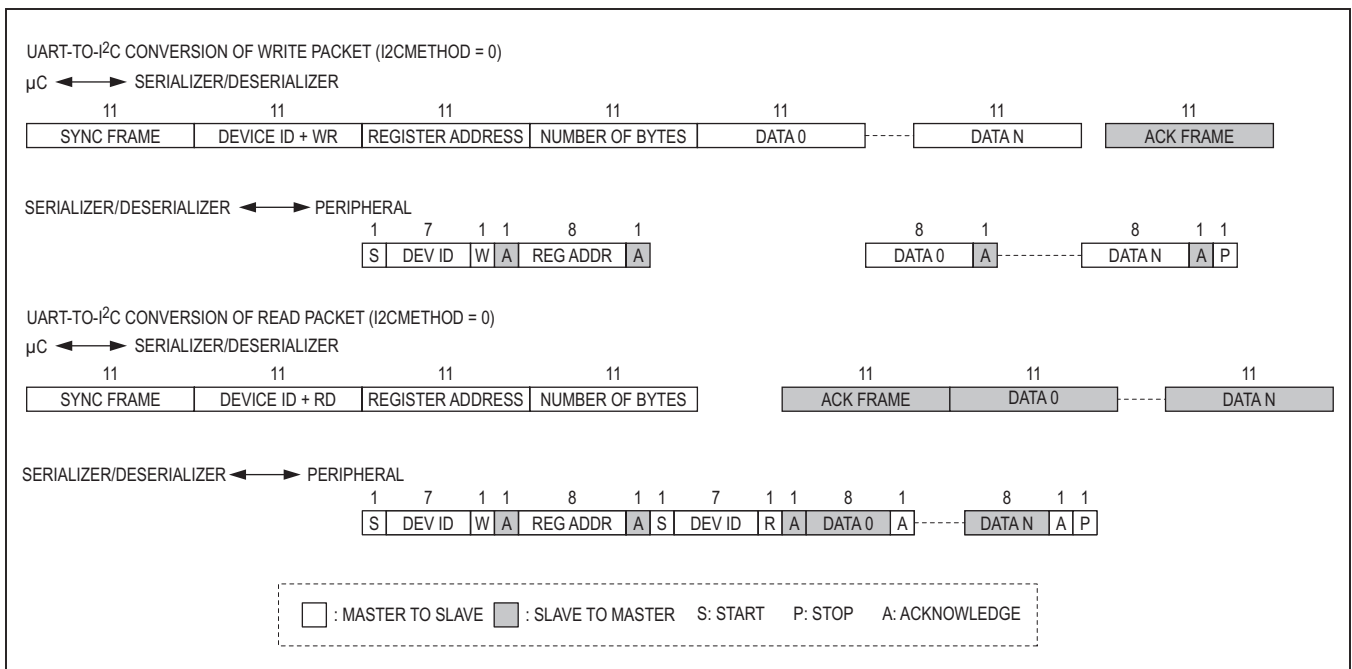

Figure 31. Format Conversion Between GMSL UART and I2C with Register Address (I2CMETHOD = 0)

As shown in Figure 31, the remote-side device converts packets going to or coming from the peripherals from UART format to I2C format and vice versa. The remote

device removes the byte number count and adds or receives the ACK between the data bytes of I2C. The I2C bit rate is the same as the UART bit rate.

**Interfacing Command-Byte-Only I<sup>2</sup>C Devices with UART**

The deserializers' UART-to-I<sup>2</sup>C conversion can interface with devices that do not require register addresses, such as the MAX7324 GPIO expander. In this mode, the I<sup>2</sup>C master ignores the register address byte and directly reads/writes the subsequent data bytes (Figure 32). Change the communication method of the I<sup>2</sup>C master using the I2CMETHOD bit. I2CMETHOD = 1 sets command-byte-only mode, while I2CMETHOD = 0 sets normal mode where the first byte in the data stream is the register address.

**UART Bypass Mode**

In bypass mode, the deserializers ignore UART commands from the μC and the μC communicates with the peripherals directly using its own defined UART protocol.

The μC cannot access the serializer/deserializer's registers in this mode. Peripherals accessed through the forward control channel using the UART interface need to handle at least one TXCLKOUT period ±10ns of jitter due to the asynchronous sampling of the UART signal by TXCLKOUT. Set MS/HVEN = high to put the control channel into bypass mode. For applications with the μC connected to the deserializer, there is a 1ms wait time between setting MS high and the bypass control channel being active. There is no delay time when switching to bypass mode when the μC is connected to the serializer. Do not send a logic-low value longer than 100μs to ensure proper GPO functionality. Bypass mode accepts bit rates down to 10kbps in either direction. See the [GPO/GPI Control](#) section for GPI functionality limitations. The control-channel data pattern should not be held low longer than 100μs if GPI control is used.



Figure 32. Format Conversion Between GMSL UART and I<sup>2</sup>C with Register Address (I2CMETHOD = 1)

**I<sup>2</sup>C Interface**

In I<sup>2</sup>C-to-I<sup>2</sup>C mode, the deserializer’s control-channel interface sends and receives data through an I<sup>2</sup>C-compatible 2-wire interface. The interface uses a serial-data line (SDA) and a serial-clock line (SCL) to achieve bidirectional communication between master and slave(s). A  $\mu$ C master initiates all data transfers to and from the device and generates the SCL clock that synchronizes the data transfer. When an I<sup>2</sup>C transaction starts on the local-side device’s control-channel port, the remote-side device’s control-channel port becomes an I<sup>2</sup>C master that interfaces with remote-side I<sup>2</sup>C peripherals. The I<sup>2</sup>C master must accept clock stretching that is imposed by the deserializer (holding SCL low). The SDA and SCL lines operate as both an input and an open-drain output. Pullup resistors are required on SDA and SCL. Each transmission consists of a START condition (Figure 6)

sent by a master, followed by the device’s 7-bit slave address plus a R/W bit, a register address byte, one or more data bytes, and finally a STOP condition.

**START and STOP Conditions**

Both SCL and SDA remain high when the interface is not busy. A master signals the beginning of a transmission with a START (S) condition by transitioning SDA from high to low while SCL is high (see Figure 33). When the master has finished communicating with the slave, it issues a STOP (P) condition by transitioning SDA from low to high while SCL is high. The bus is then free for another transmission.

**Bit Transfer**

One data bit is transferred during each clock pulse (Figure 34). The data on SDA must remain stable while SCL is high.



Figure 33. START and STOP Conditions



Figure 34. Bit Transfer

**Acknowledge**

The acknowledge bit is a clocked 9th bit that the recipient uses to handshake receipt of each byte of data (Figure 35). Thus, each byte transferred effectively requires nine bits. The master generates the 9th clock pulse, and the recipient pulls down SDA during the acknowledge clock pulse. The SDA line is stable low during the high period of the clock pulse. When the master is transmitting to the slave device, the slave device generates the acknowledge bit because the slave device is the recipient. When the slave device is transmitting to the master, the master generates the acknowledge bit because the master is the recipient. The device generates an acknowledge even when the forward control channel is not active. To prevent acknowledge generation when the forward control channel is not active, set the I2CLOCKACK bit low.

**Slave Address**

The deserializers have 7-bit long slave addresses. The bit following a 7-bit slave address is the R/W bit, which is low for a write command and high for a read command. The slave address for the deserializer is XX01XXX1 for read commands and XX01XXX0 for write commands. See Figure 36.

**Bus Reset**

The device resets the bus with the I<sup>2</sup>C START condition for reads. When the R/W bit is set to 1, the deserializers transmit data to the master, thus the master is reading from the device.



Figure 35. Acknowledge



Figure 36. Slave Address



**Format for Writing**

Writes to the deserializers comprise the transmission of the slave address with the R/W bit set to zero, followed by at least one byte of information. The first byte of information is the register address or command byte. The register address determines which register of the device is to be written by the next byte, if received. If a STOP (P) condition is detected after the register address is received, the

device takes no further action beyond storing the register address (Figure 37). Any bytes received after the register address are data bytes. The first data byte goes into the register selected by the register address, and subsequent data bytes go into subsequent registers (Figure 38). If multiple data bytes are transmitted before a STOP condition, these bytes are stored in subsequent registers because the register addresses autoincrements.



Figure 37. Format for I<sup>2</sup>C Write



Figure 38. Format for Write to Multiple Registers

**Format for Reading**

The deserializers are read using the internally stored register address as an address pointer, the same way the stored register address is used as an address pointer for a write. The pointer autoincrements after each data byte is read using the same rules as for a write. Thus, a read is initiated by first configuring the register address by performing a write (Figure 39). The master can now read consecutive bytes from the device, with the first data byte being read from the register address pointed by the previously written register address. Once the master sends a NACK, the device stops sending valid data.

**I<sup>2</sup>C Communication with Remote-Side Devices**

The deserializers support I<sup>2</sup>C communication with a peripheral on the remote side of the communication link using SCL clock stretching. While multiple masters can reside on either side of the communication link, arbitration is not provided. The connected masters need to support SCL clock stretching. The remote-side I<sup>2</sup>C bit-rate range must be set according to the local-side I<sup>2</sup>C bit rate. Supported remote-side bit rates can be found in Table 6. Set the I2CMSTBT (register 0x1C) to set the remote I<sup>2</sup>C bit rate. If using a bit rate different from 400kbps, local- and remote-side I<sup>2</sup>C setup and hold times should

be adjusted by setting the I2CSLVSH register settings on both sides.

**I<sup>2</sup>C Address Translation**

The deserializers support I<sup>2</sup>C address translation for up to two device addresses. Use address translation to assign unique device addresses to peripherals with limited I<sup>2</sup>C addresses. Source addresses (address to translate from) are stored in registers 0x18 and 0x1A. Destination addresses (address to translate to) are stored in registers 0x19 and 0x1B.

In a multilink situation where there are multiple deserializers and/or peripheral devices connected to these serializers, the deserializers support broadcast commands to control these multiple devices. Select an unused device address to use as a broadcast device address. Program all the remote-side serializer devices to translate the broadcast device address (source address stored in registers 0x0F, 0x11) to the peripherals' address (destination address stored in registers 0x10, 0x12). Any commands sent to the broadcast address (selected unused address) are sent to all deserializers and/or peripheral devices connected to the deserializers whose addresses match the translated broadcast address.



Figure 39. Format for I<sup>2</sup>C Read

**Table 6. I<sup>2</sup>C Bit Rate Ranges**

LOCAL BIT RATE	REMOTE BIT RATE RANGE	I2CMSTBT SETTING
f > 50kbps	Up to 1Mbps	Any
20kbps < f < 50kbps	Up to 400kbps	Up to 110
f < 20kbps	Up to 10kbps	000

### GPO/GPI Control

GPO on the serializer follows GPI transitions on the deserializer. This GPO/GPI function can be used to transmit signals such as a frame sync in a surround-view camera system. The GPI-to-GPO delay is 0.35ms max. Keep time between GPI transitions to a minimum 0.35ms. This includes transitions from the other deserializer in coax splitter mode. Bit D4 of register 0x06 in the deserializer stores the GPI input state. GPO is low after power-up. The  $\mu$ C can set GPO by writing to the SETGPO register bit. Do not send a logic-low value on the deserializer RX/SDA input (UART mode) longer than 100 $\mu$ s in either base or bypass mode to ensure proper GPO/GPI functionality.

**Table 7. Cable Equalizer Boost Levels**

BOOST SETTING (0x05 D[3:0])	TYPICAL BOOST GAIN (dB)
0000	2.1
0001	2.8
0010	3.4
0011	4.2
<b>0100</b>	5.2 <b>Power-up default when EQS = high</b>
0101	6.2
0110	7
0111	8.2
1000	9.4
<b>1001</b>	10.7 <b>Power-up default when EQS = low</b>
1010	11.7
1011	13

**Table 8. Output Spread**

SS	SPREAD (%)
00	No spread spectrum <b>Power-up default when SSEN = 0</b>
01	$\pm 2\%$ spread spectrum <b>Power-up default when SSEN = 1</b>
10	No spread spectrum
11	$\pm 4\%$ spread spectrum

**Table 9. Modulation Coefficients and Maximum SDIV Settings**

SPREAD-SPECTRUM SETTING (%)	MODULATION COEFFICIENT MOD (DECIMAL)	SDIV UPPER LIMIT (DECIMAL)
4	208	15
2	208	30

### Line Equalizer

The deserializer includes an adjustable line equalizer to further compensate cable attenuation at high frequencies. The cable equalizer has 11 selectable levels of compensation from 2.1dB to 13dB (Table 7). To select other equalization levels, set the corresponding register bits in the deserializer (0x05 D[3:0]). Use equalization in the deserializer, together with preemphasis in the serializer, to create the most reliable link for a given cable.

### Spread Spectrum

To reduce the EMI generated by the transitions on the serial link, the deserializer output is programmable for spread spectrum. If the serializer, paired with the MAX9278/MAX9282, has programmable spread spectrum, do not enable spread for both at the same time or their interaction will cancel benefits. The deserializer tracks the serializer spread and passes the spread to the deserializer output. The programmable spread-spectrum amplitudes are  $\pm 2\%$ , and  $\pm 4\%$  (Table 8).

The deserializer includes a sawtooth divider to control the spread-modulation rate. Autodetection of the TXCLKOUT operation range guarantees a spread-spectrum modulation frequency within 20kHz to 40kHz. Additionally, manual configuration of the sawtooth divider (SDIV: 0x03, D[5:0]) allows the user to set a modulation frequency according to the TXCLKOUT frequency. When ranges are manually selected, program the SDIV value for a fixed modulation frequency around 20kHz.

### Manual Programming of the Spread-Spectrum Divider

The modulation rate relates to the TXCLKOUT frequency as follows:

$$f_M = (1 + \text{DRS}) \frac{f_{\text{TXCLKOUT}}}{\text{MOD} \times \text{SDIV}}$$

where:

$f_M$  = Modulation frequency

DRS = DRS value (0 or 1)

$f_{\text{TXCLKOUT}}$  = TXCLKOUT frequency

MOD = Modulation coefficient given in Table 9

SDIV = 5-bit SDIV setting, manually programmed by the  $\mu$ C

To program the SDIV setting, first look up the modulation coefficient according to the desired bus-width and spread-spectrum settings. Solve the above equation for SDIV using the desired pixel clock and modulation frequencies. If the calculated SDIV value is larger than the maximum allowed SDIV value in Table 9, set SDIV to the maximum value.



Figure 40. 2:1 Coax Splitter Connection Diagram



Figure 41. Coax Connection Diagram

**Table 10. Configuration Input Map**

CX/TP	FUNCTION
High	Coax+ input. 7-bit device address is XXXXXX0 (bin).
Mid	Coax- input. 7-bit device address is XXXXXX1 (bin).
Low	Twisted pair input. 7-bit device address is XXXXXX0 (bin).

**HS/VS/DE Tracking**

The deserializer has tracking to filter out HS/VS/DE bit or packet errors. HS/VS/DE tracking is on by default when the device is in high-bandwidth mode (BWS = open), and off by default when in 3-channel or 4-channel mode (BWS = low or high). Set/clear HVTRM (D6 of register 0x15) to enable/disable HS/VS tracking. Set/clear DETREN (D5 of register 0x15) to enable/disable DE tracking. By default, the device uses a partial and full periodic tracking of

HS/DE. Set HVTRMODE = 0 (D4 of register 0x15) to disable full periodic tracking. HS/VS/DE tracking can be turned on in 3-channel and 4-channel modes to track and correct against bit errors in HS/VS/DE link bits.

**Serial Input**

The device can receive serial data from two kinds of cable: 100Ω twisted pair and 50Ω coax. (Contact the factory for devices compatible with 75Ω cables).

**Coax Splitter Mode**

In coax mode, OUT+ and OUT- of the serializer are active. This enables the use as a 1:2 splitter (Figure 40). In coax mode, connect OUT+ to IN+ of the deserializer. Connect OUT- to IN- of the second deserializer. Control-channel data is broadcast from the serializer to both deserializers and their attached peripherals. Assign a unique address to send control data to one deserializer. Leave all unused IN\_ pins unconnected, or connect them to ground through 50Ω and a capacitor for increased power-supply rejection. If OUT- is not used, connect OUT- to V<sub>DD</sub> through a 50Ω resistor (Figure 41). When there are μCs at the serializer, and at each deserializer, only one μC can communicate at a time. Disable forward and reverse channel links according to the communicating deserializer connection to prevent contention in I<sup>2</sup>C-to-I<sup>2</sup>C mode. Use ENREVP or ENREVN register bits to disable/enable the control-channel link. In UART mode, the serializer provides arbitration of the control-channel link.

**Cable Type Configuration Input**

CX/TP determine the power-up state of the serial input. In coax mode, CX/TP also determine which coax input is active, along with the default device address (Table 10).

**Color Lookup Tables**

The deserializer includes three color lookup tables (LUT) to support automatic translation of RGB pixel values. This feature can be used for color gamma correction, brightness/contrast or for other purposes. There are three lookup tables, each 8 bits wide and 256 entries deep, enabling a 1:1 translation of 8-bit input values to any 8-bit output value for each color (24 bits total).

**Programming and Verifying LUT Data**

The μC must set the LUTPROG register bit to 1 before programming and verifying the tables. To program a LUT, the μC generates a write packet with register address set to the assigned register address for respective LUT (0x7D, 0x7E, or 0x7F). The deserializer writes data in the packet to the respective LUT starting from the LUT address location set in LUTADDR register. Successive bytes in the data packet are written to the next LUT address location; however, each new data packet write starts from the address location stored in the LUTADDR register. Use 0x00 for LUTADDR and 0x00 as the number of bytes field in UART packet, when writing a 256 byte data block, because 8-bit wide number of bytes field cannot normally represent 9-bit wide “256” value. There is no number of bytes field in I<sup>2</sup>C-to-I<sup>2</sup>C modes.

To readback the contents of an LUT, the μC generates a read packet with register address set to the assigned register address for respective LUT (0x7D, 0x7E, or 0x7F). The deserializer outputs read data from the respective LUT starting from the LUT address location set in LUT\_ADDR register. Similar to the write operation, use

0x00 for LUTADDR and 0x00 as the number of bytes field in UART packet, when reading a 256-byte data block.

**LUT Color Translation**

After power-up or going out of sleep or power-down modes, LUT translation is disabled and LUT contents are unknown. After program and verify operations are finished, in order to enable LUT translations, set LUTPROG bit to 0 and set the respective LUT enable bits (RED\_LUT\_EN, GRN\_LUT\_EN, BLU\_LUT\_EN) to 1 to enable the desired LUT translation function. Only the selected colors are translated by the LUT (the other colors are not touched). The μC does not need to fill in all three color lookup tables if all three color translations are not needed.

After a pixel is deserialized, decoded, and decrypted (if necessary), it is segmented into its color components: red, green, and blue (RGB), according to [Table 11](#) and [Figure 42](#). If LUT translation is enabled, each 8-bit pretranslation color value is used as address to the respective LUT table to look up the corresponding (translated) 8-bit color value.

**LUT Bit Width**

In 4-channel mode and high-bandwidth mode, 24 bits are available for color data (8 bits per color) and each LUT is used for 8-bit to 8-bit color translation. In 3-channel mode, the deserializer can receive only up to 18-bit color (6 bits per color). The LUT tables can translate from 6-bit to 6-bit, using the first 64 locations (0x00 to 0x3F). Program the MSB 2 bits of each LUT value to 00. Alternatively, program full 8-bit values to each LUT for 6-bit to 8-bit color translation.

**Table 11. Pixel Data Format**

DOUT [5:0]	DOUT [11:6]	DOUT [17:12]	DOUT 18	DOUT 19	DOUT 20	DOUT [22:21]	DOUT [24:23]	DOUT [26:25]
R[5:0]	G[5:0]	B[5:0]	HS	VS	DE	R[7:6]	G[7:6]	B[7:6]



Figure 42. LUT Dataflow

**Recommended LUT Program Procedure**

- 1) Write LUTPROG = 1 to register 0x7C. Keep BLULUTEN = 0, GRNLUTEN = 0, REDLUTEN = 0 (write 0x08 to register 0x7C).
- 2) Write contents of red LUT with a single write packet. For 24-bit RGB, use 0x7D as register address and 0x00 as number of bytes (UART only) and write 256 bytes. For 18-bit RGB, use 0x7D as register address and 0x40 as number of bytes (UART only) and write 64 bytes. (Optional: Multiple write packets can be used if LUTADDR is set before each LUT write packet.)
- 3) Read contents of red LUT and verify that they are correct. Use the same register address and number of bytes used in the previous step.
- 4) Repeat steps 2 and 3 for the green LUT, using 0x7E as the register address
- 5) Repeat steps 2 and 3 for the blue LUT, using 0x7F as the register address
- 6a) To finish the program and verify routine, without enabling the LUT color translation, write LUTPROG = 0 (Write 0x00 to register 0x7C).
- 6b) To finish the program and verify routine, and start LUT color translation, write LUTPROG = 0, BLULUTEN = 1, GRNLUTEN = 1, REDLUTEN = 1 (Write 0x07 to register 0x7C).

**Table 12. Reverse Control-Channel Modes**

HIGHIMM BIT OR SD/HIM PIN SETTING	REVFAST BIT	REVERSE CONTROL-CHANNEL MODE	MAX UART/I <sup>2</sup> C BIT RATE (kbps)
LOW (1)	X	Legacy reverse control-channel mode (compatible with all GMSL devices)	1000
HIGH (1)	0	High-immunity mode	500
	1	Fast high-immunity mode	1000

X = Don't care.

**Table 13. Fast High-Immunity Mode Requirements**

BWS SETTING	ALLOWED TXCLKOUT FREQUENCY (MHz)
Low	> 41.66
High	> 30
Open	> 83.33

**Note:** Fast high-immunity mode requires DRS = 0.

### High-Immunity Reverse Control-Channel Mode

The deserializer contains a high-immunity reverse control-channel mode, which has increased robustness at half the bit rate over the standard GMSL reverse control-channel link (Table 12). Connect a 30kΩ resistor to GPO/HIM on the serializer, and SD/HIM on the deserializer to use high-immunity mode at power-up. Set the HIGHIMM bit high in both the serializer and deserializer to enable high-immunity mode at any time after power-up. Set the HIGHIMM bit low in both the serializer and deserializer to use the legacy reverse control-channel mode. The deserializer reverse control-channel mode is not available for 500μs/1.92ms after the reverse control-channel mode is changed through the serializer/deserializer's HIGHIMM bit setting, respectively. The user must set SD/HIM and GPO/HIM or the HIGHIMM bits to the same value for proper reverse control-channel communication.

In high-immunity mode, set HPFTUNE = 00 in the equalizer, if the serial bit rate = [TXCLKOUT x 30 (BWS = low or open) or 40 (BWS = high)] is larger than 1Gbps when BWS is low or high. When BWS = open, set HPFTUNE = 00 when the serial bit rate is larger than 2GBps. In addition, use 47nF AC-coupling capacitors. Note that legacy reverse control-channel mode may not function when using 47nF AC-coupling capacitors.

By default, high-immunity mode uses a 500kbps bit rate. Set REVFAST = 1 (D7 in register 0x1A in the serializer and register 0x11 in the deserializer) in both devices to use a 1Mbps bit rate. Certain limitations apply when using the fast high-immunity mode (Table 13).

### Sleep Mode

The deserializers have sleep mode to reduce power consumption. To power up the devices into sleep mode, set MS = high when CDS = high (display applications). The devices also enter or exit sleep mode by a command from a μC using the control channel. Set the SLEEP bit to 1 to initiate sleep mode. Entering sleep mode resets the HDCP registers, but not the configuration registers. The deserializer sleeps after serial link inactivity or 8ms (whichever arrives first) after setting its SLEEP = 1. Do not send serial data to the deserializer to prevent wakeup. See the [Link Startup Procedure](#) section for details on waking up the device for different μC and starting conditions.

To wake up from the local side, send an arbitrary control-channel command to deserializer, wait for 5ms for the chip to power up, and then write 0 to SLEEP register bit to make the wake-up permanent. To wake up from the remote side, enable serialization. The deserializer detects the activity on the serial link and then when it locks, it automatically sets its SLEEP register bit to 0.

### Power-Down Mode

The deserializers have a power-down mode that further reduces power consumption compared to sleep mode. Set PWDN low to enter power-down mode. In power-down, the LVDS outputs remain high impedance. Entering power-down resets the device's registers. Upon exiting power-down, the state of external pins ADD2–ADD0, CX/TP, I2CSEL, SD, HIM, and BWS are latched.

### Configuration Link

The control channel can operate in a low-speed mode called configuration link in the absence of a clock input. This allows a microprocessor to program configuration registers before starting the video link. An internal oscillator provides the clock for the configuration link. Set CLINKEN = 1 on the serializer to enable configuration link. Configuration link is active until the video link is enabled. The video link overrides the configuration link and attempts to lock when SEREN = 1.

**Link Startup Procedure**

Table 14 lists the startup procedure for display applications. Table 15 lists the startup procedure for image-sensing applications. The control channel is

available after the video link or the configuration link is established. If the deserializer powers up after the serializer, the control channel becomes unavailable for 2ms after power-up.

**Table 14. Startup Procedure for Video-Display Applications (CDS = Low)**

NO.	µC	SERIALIZER		DESERIALIZER
		(AUTOSTART ENABLED)	(AUTOSTART DISABLED)	
—	µC connected to serializer.	Sets all configuration inputs. If any configuration inputs are available on one end of the link but not the other, always connects that configuration input low.	Sets all configuration inputs. If any configuration inputs are available on one end of the link but not the other, always connects that configuration input low.	Sets all configuration inputs. If any configuration inputs are available on one end of the link but not the other, always connects that configuration input low.
1	Powers up.	Powers up and loads default settings. Establishes video link when valid TXCLK available.	Powers up and loads default settings.	Powers up and loads default settings. Locks to video link signal if available.
2	Enables serial link by setting SEREN = 1 or configuration link by setting SEREN = 0 and CLINKEN = 1 (if valid PCLK not available) and gets an acknowledge. Waits for link to be establish (~3ms).	—	Establishes configuration or video link.	Locks to configuration or video link signal.
3	Writes configuration bits in the serializer/deserializer and gets an acknowledge.	Configuration changed from default settings.		Configuration changed from default settings.
4	If not already enabled, sets SEREN = 1, gets an acknowledge and waits for video link to be established (~3ms).	Establishes video link when valid TXCLK available (if not already enabled).		Locks to video link signal (if not already locked).
5	Begin sending video data to input.	Video data serialized and sent across serial link.		Video data received and deserialized.





Figure 43. State Diagram, CDS = Low (Display Application)

**Table 15. Startup Procedure for Image-Sensing Applications (CDS = High)**

NO.	μC	SERIALIZER		DESERIALIZER
		(AUTOSTART ENABLED)	(AUTOSTART DISABLED)	
—	μC connected to deserializer.	Sets all configuration inputs.	Sets all configuration inputs.	Sets all configuration inputs.
1	Powers up.	Powers up and loads default settings. Establishes video link when valid TXCLK available.	Powers up and loads default settings. Goes to sleep after 8ms.	Powers up and loads default settings. Locks to video link signal if available.
2	Writes deserializer configuration bits and gets an acknowledge.	—	—	Configuration changed from default settings.
3	Wakes up the serializer by sending dummy packet, and then writing SLEEP = 0 within 8ms. May not get an acknowledge (or gets a dummy acknowledge) if not locked.	—	Wakes up.	—
4	Writes serializer configuration bits. May not get an acknowledge (or gets a dummy acknowledge) if not locked.	Configuration changed from default settings.		—
5	If not already enabled, sets SEREN = 1, gets an acknowledge and waits for serial link to be established (~3ms).	Establishes video link when valid TXCLK available (if not already enabled).		Locks to video link signal (if not already locked).
6	Begin sending video data to input.	Video data serialized and sent across serial link.		Video data received and deserialized.



Figure 44. State Diagram, CDS = High (Camera Application)

## High-Bandwidth Digital Content Protection (HDCP)

**Note:** The explanation of HDCP operation in this data sheet is provided as a guide for general understanding. Implementation of HDCP in a product must meet the requirements given in the HDCP System v1.3 Amendment for GMSL, which is available from DCP.

HDCP has two main phases of operation: authentication and the link integrity check. The  $\mu\text{C}$  starts authentication by writing to the START\_AUTHENTICATION bit in the GMSL serializer. The GMSL serializer generates a 64-bit random number. The host  $\mu\text{C}$  first reads the 64-bit random number from the GMSL serializer and writes it to the deserializer. The  $\mu\text{C}$  then reads the GMSL serializer public key selection vector (AKSV) and writes it to the deserializer. The  $\mu\text{C}$  then reads the deserializer KSV (BKSV) and writes it to the GMSL serializer. The  $\mu\text{C}$  begins checking BKSV against the revocation list. Using the cipher, the GMSL serializer and deserializer calculate a 16-bit response value,  $R_0$  and  $R_0'$ , respectively. The GMSL amendment for HDCP reduces the 100ms minimum wait time allowed for the receiver to generate  $R_0'$  (specified in HDCP rev 1.3) to 128 pixel clock cycles in the GMSL amendment.

There are two response-value comparison modes: internal comparison and  $\mu\text{C}$  comparison. Set EN\_INT\_COMP = 1 to select internal comparison mode. Set EN\_INT\_COMP = 0 to select  $\mu\text{C}$  comparison mode. In internal comparison mode, the  $\mu\text{C}$  reads the deserializer response  $R_0'$  and writes it to the GMSL serializer. The GMSL serializer compares  $R_0'$  to its internally generated response value  $R_0$ , and sets R0\_RI\_MATCHED. In  $\mu\text{C}$  comparison mode, the  $\mu\text{C}$  reads and compares the  $R_0/R_0'$  values from the GMSL serializer/deserializer.

During response-value generation and comparison, the host  $\mu\text{C}$  checks for a valid BKSV (having 20 1s and 20 0s is also reported in BKSV\_INVALID) and checks BKSV against the revocation list. If BKSV is not on the list and the response values match, the host authenticates the link. If the response values do not match, the  $\mu\text{C}$  resamples the response values (as described in HDCP rev 1.3, Appendix C). If resampling fails, the  $\mu\text{C}$  restarts authentication by setting the RESET\_HDCP bit in the GMSL serializer. If BKSV appears on the revocation list, the host cannot transmit data that requires protection. The host knows when the link is authenticated and decides when to output data requiring protection. The  $\mu\text{C}$  performs a link integrity check every 128 frames or every 2s  $\pm$ 0.5s. The GMSL serializer/deserializer generate response values

every 128 frames. These values are compared internally (internal comparison mode) or can be compared in the host  $\mu\text{C}$ .

In addition, the GMSL serializer/deserializer provide response values for the enhanced link verification. Enhanced link verification is an optional method of link verification for faster detection of loss-of-synchronization. For this option, the GMSL serializer and deserializer generate 8-bit enhanced link-verification response values (PJ and PJ') every 16 frames. The host must detect three consecutive PJ/PJ' mismatches before resampling.

### Encryption Enable

The GMSL link transfers either encrypted or nonencrypted data. To encrypt data, the host  $\mu\text{C}$  sets the encryption enable (ENCRYPTION\_ENABLE) bit in both the GMSL serializer and deserializer. The  $\mu\text{C}$  must set ENCRYPTION\_ENABLE in the same VSYNC cycle in both the GMSL serializer and deserializer (no internal VSYNC falling edges between the two writes). The same timing applies when clearing ENCRYPTION\_ENABLE to disable encryption.

**Note:** ENCRYPTION\_ENABLE enables/disables encryption on the GMSL irrespective of the content. To comply with HDCP, the  $\mu\text{C}$  must not allow content requiring encryption to cross the GMSL unencrypted.

The  $\mu\text{C}$  must complete the authentication process before enabling encryption. In addition, encryption must be disabled before starting a new authentication session.

### Synchronization of Encryption

The video vertical sync (VSYNC) synchronizes the start of encryption. Once encryption has started, the GMSL generates a new encryption key for each frame and each line, with the internal falling edge of VSYNC and HSYNC. Rekeying is transparent to data and does not disrupt the encryption of video or audio data.

### Repeater Support

The GMSL serializer/deserializer include features to build an HDCP repeater. An HDCP repeater receives and decrypts HDCP content and then encrypts and transmits on one or more downstream links. A repeater can also use decrypted HDCP content (e.g., to display on a screen). To support HDCP repeater-authentication protocol, the deserializer has a REPEATER register bit. This register bit must be set to 1 by a  $\mu\text{C}$  (most likely on the repeater module). Both the GMSL serializer and deserializer use SHA-1 hash-value calculation over the assembled KSV lists. HDCP GMSL links support a maximum of 15 receivers (total number including the ones in repeater modules).

If the total number of downstream receivers exceeds 14, the  $\mu\text{C}$  must set the MAX\_DEVS\_EXCEEDED register bit when it assembles the KSV list.

**HDCP Authentication Procedures**

The GMSL serializer generates a 64-bit random number exceeding the HDCP requirement. The GMSL serializer/deserializer internal one-time programmable (OTP) memories contain a unique HDCP keyset programmed at the factory. The host  $\mu\text{C}$  initiates and controls the HDCP authentication procedure. The GMSL serializer and deserializer generate HDCP authentication response values for the verification of authentication. Use the following procedures to authenticate the HDCP GMSL encryption

(refer to the HDCP 1.3 Amendment for GMSL for details). The  $\mu\text{C}$  must perform link integrity checks while encryption is enabled (see Table 17). Any event that indicates that the deserializer has lost link synchronization should retrigger authentication. The  $\mu\text{C}$  must first write 1 to the RESET\_HDCP bit in the GMSL serializer before starting a new authentication attempt.

**HDCP Protocol Summary**

Table 10, Table 11, and Table 12 list the summaries of the HDCP protocol. These tables serve as an implementation guide only. Meet the requirements in the GMSL amendment for HDCP to be in full compliance.

**Table 16. Startup, HDCP Authentication, and Normal Operation (Deserializer is Not a Repeater)—First Part of the HDCP Authentication Protocol**

NO.	$\mu\text{C}$	HDCP GMSL SERIALIZER	HDCP GMSL DESERIALIZER
1	Initial state after power-up.	Powers up waiting for HDCP authentication.	Powers up waiting for HDCP authentication.
2	Makes sure that A/V data not requiring protection (low-value content) is available at the GMSL serializer inputs (such as blue or informative screen). Alternatively, uses the FORCE_VIDEO and FORCE_AUDIO bits of the GMSL serializer to mask A/V data at the input of the GMSL serializer. Starts the link by writing SEREN = H or link starts automatically if AUTOS is low.	—	—
3	—	Starts serialization and transmits low-value content A/V data.	Locks to incoming data stream and outputs low-value content A/V data.
4	Reads the locked bit of the deserializer and makes sure the link is established.	—	—
5	Optionally writes a random-number seed to the GMSL serializer.	Combines seed with internally generated random number. If no seed provided, only internal random number is used.	—
6	If HDCP encryption is required, starts authentication by writing 1 to the START_AUTHENTICATION bit of the GMSL serializer.	Generates (stores) AN, and resets the START_AUTHENTICATION bit to 0.	—
7	Reads AN and AKSV from the GMSL serializer and writes to the deserializer.	—	Generates R0' triggered by the $\mu\text{C}$ 's write of AKSV.
8	Reads the BKSv and REPEATER bit from the deserializer and writes to the GMSL serializer.	Generates R0, triggered by the $\mu\text{C}$ 's write of BKSv.	—

**Table 16. Startup, HDCP Authentication, and Normal Operation (Deserializer is Not a Repeater)—First Part of the HDCP Authentication Protocol (continued)**

NO.	μC	HDCP GMSL SERIALIZER	HDCP GMSL DESERIALIZER
9	Reads the INVALID_BKSV bit of the GMSL serializer and continues with authentication if it is 0. Authentication can be restarted if it fails (set RESET_HDCP = 1 before restarting authentication).	—	—
10	Reads R0' from the deserializer and reads R0 from the GMSL serializer. If they match, continues with authentication; otherwise, retries up to two more times (optionally, GMSL serializer comparison can be used to detect if R0/R0' match). Authentication can be restarted if it fails (set RESET_HDCP = 1 before restarting authentication).	—	—
11	Waits for the VSYNC falling edge (internal to the GMSL serializer) and then sets the ENCRYPTION_ENABLE bit to 1 in the deserializer and GMSL serializer (if the FC is not able to monitor VSYNC, it can utilize the VSYNC_DET bit in the GMSL serializer).	Encryption enabled after the next VSYNC falling edge.	Decryption enabled after the next VSYNC falling edge.
12	Checks that BKSV is not in the Key Revocation list and continues if it is not. Authentication can be restarted if it fails. <b>Note:</b> Revocation list check can start after BKSV is read in step 8.	—	—
13	Starts transmission of A/V content that needs protection.	Performs HDCP encryption on high-value content A/V data.	Performs HDCP decryption on high-value content A/V data.

**Table 17. Link Integrity Check (Normal)—Performed Every 128 Frames After Encryption is Enabled**

NO.	μC	HDCP GMSL SERIALIZER	HDCP GMSL DESERIALIZER
1	—	Generates Ri and updates the RI register every 128 VSYNC cycles.	Generates Ri' and updates the RI' register every 128 VSYNC cycles.
2	—	Continues to encrypt and transmit A/V data.	Continues to receive, decrypt, and output A/V data.
3	Every 128 video frames (VSYNC cycles) or every 2s.	—	—
4	Reads RI from the GMSL serializer.	—	—
5	Reads RI' from the deserializer.	—	—
6	Reads RI again from the GMSL serializer and makes sure it is stable (matches the previous RI that it has read from the GMSL serializer). If RI is not stable, go back to step 5.	—	—
7	If RI matches RI', the link integrity check is successful; go back to step 3.	—	—
8	If RI does not match RI', the link integrity check fails. After the detection of failure of link integrity check, the FC makes sure that A/V data not requiring protection (low-value content) is available at the GMSL serializer inputs (such as blue or informative screen). Alternatively, the FORCE_VIDEO and FORCE_AUDIO bits of the GMSL serializer can be used to mask A/V data input of the GMSL serializer.	—	—
9	Writes 0 to the ENCRYPTION_ENABLE bit of the GMSL serializer and deserializer.	Disables encryption and transmits low-value content A/V data.	Disables decryption and outputs low-value content A/V data.
10	Restarts authentication by writing 1 to the RESET_HDCP bit followed by writing 1 to the START_AUTHENTICATION bit in the GMSL serializer.	—	—

**Table 18. Optional Enhanced Link Integrity Check—Performed Every 16 Frames After Encryption is Enabled**

NO.	μC	HDCP GMSL SERIALIZER	HDCP GMSL DESERIALIZER
1	—	Generates PJ and updates the PJ register every 16 VSYNC cycles.	Generates PJ' and updates the PJ' register every 16 VSYNC cycles.
2	—	Continues to encrypt and transmit A/V data.	Continues to receive, decrypt, and output A/V data.
3	Every 16 video frames, reads PJ from the GMSL serializer and PJ' from the deserializer.	—	—
4	If PJ matches PJ', the enhanced link integrity check is successful; go back to step 3.	—	—
5	If there is a mismatch, retry up to two more times from step 3. Enhanced link integrity check fails after 3 mismatches. After the detection of failure of enhanced link integrity check, the μC makes sure that A/V data not requiring protection (low-value content) is available at the GMSL serializer inputs (such as blue or informative screen). Alternatively, the FORCE_VIDEO and FORCE_AUDIO bits of the GMSL serializer can be used to mask A/V data input of the GMSL serializer.	—	—
6	Writes 0 to the ENCRYPTION_ENABLE bit of the GMSL serializer and deserializer.	Disables encryption and transmits low-value content A/V data.	Disables decryption and outputs low-value content A/V data.
7	Restarts authentication by writing 1 to the RESET_HDCP bit followed by writing 1 to the START_AUTHENTICATION bit in the GMSL serializer.	—	—

Example Repeater Network—Two  $\mu$ Cs

The example shown in Figure 44 has one repeater and two  $\mu$ Cs. Table 19 summarizes the authentication operation.



Figure 45. Example Network with One Repeater and Two  $\mu$ Cs (Tx = GMSL Serializer's, Rx = Deserializer's)

**Table 19. HDCP Authentication and Normal Operation (One Repeater, Two  $\mu$ Cs)—First and Second Parts of the HDCP Authentication Protocol**

NO.	$\mu$ C_B	$\mu$ C_R	HDCP GMSL SERIALIZER (TX_B1, TX_R1, TX_R2)	HDCP GMSL DESERIALIZER (RX_R1, RX_D1, RX_D2)
			TX_B1 CDS = 0 TX_R1 CDS = 0 TX_R2 CDS = 0	RX_R1 CDS = 1 RX_D1 CDS = 0 RX_D2 CDS = 0
1	Initial state after power-up.	Initial state after power-up.	All: Power-up waiting for HDCP authentication.	All: Power-up waiting for HDCP authentication.
2	—	Writes REPEATER = 1 in RX_R1. Retries until proper acknowledge frame received. <b>Note:</b> This step must be completed before the first part of authentication is started between TX_B1 and RX_R1 by the $\mu$ C_B (step 7). For example, to satisfy this requirement, RX_R1 can be held at power-down until $\mu$ C_R is ready to write the REPEATER bit, or $\mu$ C_B can poll $\mu$ C_R before starting authentication.	—	—



**Table 19. HDCP Authentication and Normal Operation (One Repeater, Two μCs)—First and Second Parts of the HDCP Authentication Protocol (continued)**

NO.	μC_B	μC_R	HDCP GMSL SERIALIZER (TX_B1, TX_R1, TX_R2)	HDCP GMSL DESERIALIZER (RX_R1, RX_D1, RX_D2)
			TX_B1 CDS = 0 TX_R1 CDS = 0 TX_R2 CDS = 0	RX_R1 CDS = 1 RX_D1 CDS = 0 RX_D2 CDS = 0
3	Makes sure that A/V data not requiring protection (low-value content) is available at the TX_B1 inputs (such as blue or informative screen). Alternatively, the FORCE_VIDEO and FORCE_AUDIO bits of TX_B1 can be used to mask A/V data input of TX_B1. Starts the link between TX_B1 and RX_R1 by writing SEREN = H to TX_B1, or link starts automatically if AUTOS is low.	—	TX_B1: Starts serialization and transmits low-value content A/V data.	RX_R1: Locks to incoming data stream and outputs low-value content A/V data.
4	—	Starts all downstream links by writing SEREN = H to TX_R1, TX_R2, or links start automatically if AUTOS of transmitters are low.	TX_R1, TX_R2: Starts serialization and transmits low-value content A/V data.	RX_D1, RX_D2: Locks to incoming data stream and outputs low-value content A/V data.
5	Reads the locked bit of RX_R1 and makes sure the link between TX_B1 and RX_R1 is established.	Reads the locked bit of RX_D1 and makes sure the link between TX_R1 and RX_D1 is established. Reads the locked bit of RX_D2 and makes sure the link between TX_R2 and RX_D2 is established.	—	—
6	Optionally, writes a random number seed to TX_B1.	Writes 1 to the GPIO_0_FUNCTION and GPIO_1_FUNCTION bits in RX_R1 to change GPIO functionality used for HDCP purpose. Optionally, writes a random-number seed to TX_R1 and TX_R2.	—	—
7	Starts and completes the first part of the authentication protocol between TX_B1, RX_R1 (see steps 6–10 in Table 11).	—	TX_B1: According to commands from μC_B, generates AN, computes R0.	RX_R1: According to commands from μC_B, computes R0'.

**Table 19. HDCP Authentication and Normal Operation (One Repeater, Two μCs)—First and Second Parts of the HDCP Authentication Protocol (continued)**

NO.	μC_B	μC_R	HDCP GMSL SERIALIZER (TX_B1, TX_R1, TX_R2)	HDCP GMSL DESERIALIZER (RX_R1, RX_D1, RX_D2)
			TX_B1 CDS = 0 TX_R1 CDS = 0 TX_R2 CDS = 0	RX_R1 CDS = 1 RX_D1 CDS = 0 RX_D2 CDS = 0
8	—	When GPIO_1 = 1 is detected, starts and completes the first part of the authentication protocol between the (TX_R1, RX_D1) and (TX_R2, RX_D2) links (see steps 6–10 in Table 11).	TX_R1, TX_R2: According to commands from μC_R, generates AN, computes R0.	RX_D1, RX_D2: According to commands from μC_R, computes R0'.
9	Waits for the VSYNC falling edge and then enables encryption on the (TX_B1, RX_R1) link. Full authentication is not complete yet so it makes sure A/V content that needs protection is not transmitted. Since REPEATER = 1 was read from RX_R1, the second part of authentication is required.	—	TX_B1: Encryption enabled after next VSYNC falling edge.	RX_R1: Decryption enabled after next VSYNC falling edge.
10	—	When GPIO_0 = 1 is detected, enables encryption on the (TX_R1, RX_D1) and (TX_R2, RX_D2) links.	TX_R1, TX_R2: Encryption enabled after next VSYNC falling edge.	RX_D1, RX_D2: Decryption enabled after next VSYNC falling edge.
11	—	Blocks control channel from μC_B side by setting REVCCEN = FWDCEN = 0 in RX_R1. Retries until proper acknowledge frame received.	—	RX_R1: Control channel from serializer side (TX_B1) is blocked after FWDCEN = REVCCEN = 0 is written.
12	Waits for some time to allow μC_R to make the KSV list ready in RX_R1. Then polls (reads) the KSV_LIST_READY bit of RX_R1 regularly until proper acknowledge frame is received and bit is read as 1.	Writes BKSVs of RX_D1 and RX_D2 to the KSV list in RX_R1. Then, calculates and writes the BINFO register of RX_R1.	—	RX_R1: Triggered by μC_R's write of BINFO, calculates hash value (V') on the KSV list, BINFO and the secret-value M0'.
13	—	Writes 1 to the KSV_LIST_READY bit of RX_R1 and then unblocks the control channel from the μC_B side by setting REVCCEN = FWDCEN = 1 in RX_R1.	—	RX_R1: Control channel from the serializer side (TX_B1) is unblocked after FWDCEN = REVCCEN = 1 is written.

**Table 19. HDCP Authentication and Normal Operation (One Repeater, Two μCs)—First and Second Parts of the HDCP Authentication Protocol (continued)**

NO.	μC_B	μC_R	HDCP GMSL SERIALIZER (TX_B1, TX_R1, TX_R2)	HDCP GMSL DESERIALIZER (RX_R1, RX_D1, RX_D2)
			TX_B1 CDS = 0 TX_R1 CDS = 0 TX_R2 CDS = 0	RX_R1 CDS = 1 RX_D1 CDS = 0 RX_D2 CDS = 0
14	Reads the KSV list and BINFO from RX_R1 and writes them to TX_B1. If any of the MAX_DEVS_EXCEEDED or MAX_CASCADE_EXCEEDED bits is 1, then authentication fails. <b>Note:</b> BINFO must be written after the KSV list.	—	TX_B1: Triggered by μC_B's write of BINFO, calculates hash value (V) on the KSV list, BINFO and the secret-value M0.	—
15	Reads V from TX_B1 and V' from RX_R1. If they match, continues with authentication; otherwise, retries up to two more times.	—	—	—
16	Searches for each KSV in the KSV list and BKSV of RX_R1 in the Key Revocation list.	—	—	—
17	If keys are not revoked, the second part of the authentication protocol is completed.	—	—	—
18	Starts transmission of A/V content that needs protection.	—	All: Perform HDCP encryption on high-value A/V data.	All: Perform HDCP decryption on high-value A/V data.

**Detection and Action Upon New Device Connection**

When a new device is connected to the system, the device must be authenticated and the device's KSV checked against the revocation list. The downstream μCs can set the NEW\_DEV\_CONN bit of the upstream receiver and invoke an interrupt to notify upstream μCs.

**Notification of Start of Authentication and Enable of Encryption to Downstream Links**

HDCP repeaters do not immediately begin authentication upon startup or detection of a new device, but instead wait for an authentication request from the upstream transmitter/repeaters.

Use the following procedure to notify downstream links of the start of a new authentication request:

- 1) Host μC begins authentication with the HDCP repeater's input receiver.
- 2) When AKSV is written to HDCP repeater's input receiver, its AUTH\_STARTED bit is automatically set and its GPIO1 goes high (if GPIO1\_FUNCTION is set to high).
- 3) HDCP repeater's μC waits for a low-to-high transition on HDCP repeater input receiver's AUTH\_STARTED bit and/or GPIO1 (if configured) and starts authentication downstream.
- 4) HDCP repeater's μC resets the AUTH\_STARTED bit.

Set GPIO0\_FUNCTION to high to have GPIO0 follow the ENCRYPTION\_ENABLE bit of the receiver. The repeater  $\mu$ C can use this function for notification when encryption is enabled/disabled by an upstream  $\mu$ C.

## Applications Information

### Self PRBS Test

The serializers include a PRBS pattern generator that works with bit-error verification in the deserializer. To run the PRBS test, first disable HDCP encryption. Next, set DISHSFILT, DISVSFILT, and DISDEFILT to 1, to disable glitch filter in the deserializer. Then, set PRBSEN = 1 (0x04, D5) in the serializer and then in the deserializer. To exit the PRBS test, set PRBSEN = 0 (0x04, D5) in the deserializer and then in the serializer.

The deserializer also includes a PRBS mode compatible with the MAX9271/MAX9273 serializers. To run the MAX9271/MAX9273 compatible PRBS test, first set PRBSTYPE = 1 (deserializer D7, Register 0x06). Next, set DISHSFILT, DISVSFILT, and DISDEFILT to 1, to disable glitch filter in the deserializer. Then, set PRBSEN = 1 (0x04, D5) in the deserializer and then in the serializer. To exit the PRBS test, set PRBSEN = 0 (0x04, D5) in the serializer (the deserializer PRBSEN should automatically clear).

### Error Checking

The deserializers check the serial link for errors and store the number of decoding errors in the 8-bit registers DECERR (0x0D). If a large number of decoding errors are detected within a short duration (error rate  $\geq 1/4$ ), the deserializers lose lock and stop the error counter. The deserializers then attempt to relock to the serial data. DECERR reset upon successful video link lock, successful readout of the register (through  $\mu$ C), or whenever auto error reset is enabled. The deserializers use a separate PRBS Register during the internal PRBS test, and DECERR are reset to 0x00.

### $\overline{\text{ERR}}$ Output

The deserializers have an open-drain  $\overline{\text{ERR}}$  output. This output asserts low whenever the number of decoding errors exceeds the error thresholds during normal operation, or when at least 1 PRBS error is detected during PRBS test.  $\overline{\text{ERR}}$  reasserts high whenever DECERR resets, due to DECERR readout, video link lock, or auto error reset.

### Auto Error Reset

The default method to reset errors is to read the respective error registers in the deserializers (0x0D and

0x0E). Auto error reset clears the error counters DECERR and the  $\overline{\text{ERR}}$  output  $\sim 1\mu\text{s}$  after  $\overline{\text{ERR}}$  goes low. Auto error reset is disabled on power-up. Enable auto error reset through AUTORST (0x06, D5). Auto error reset does not run when the device is in PRBS test mode.

### Dual $\mu$ C Control

Usually systems have one microcontroller to run the control channel, located on the serializer side for display applications or on the deserializer side for image-sensing applications. However, a  $\mu$ C can reside on each side simultaneously, and trade off running the control channel. In this case, each  $\mu$ C can communicate with the serializer and deserializer and any peripheral devices.

Contention occurs if both  $\mu$ Cs attempt to use the control channel at the same time. It is up to the user to prevent this contention by implementing a higher level protocol. In addition, the control channel does not provide arbitration between I<sup>2</sup>C masters on both sides of the link. An acknowledge frame is not generated when communication fails due to contention. If communication across the serial link is not required, the  $\mu$ Cs can disable the forward and reverse control channel using the FWCCEN and REVCCEN bits (0x04, D[1:0]) in the serializer/deserializer. Communication across the serial link is stopped and contention between  $\mu$ Cs cannot occur.

As an example of dual  $\mu$ C use in an image-sensing application, the serializer can be in sleep mode and waiting for wake-up by the  $\mu$ C on the deserializer side. After wake-up, the serializer-side  $\mu$ C assumes master control of the serializer's registers.

### Changing the Clock Frequency

It is recommended that the serial link be enabled after the video clock ( $f_{\text{TXCLKOUT}}$ ) and the control-channel clock ( $f_{\text{UART}}/f_{\text{I2C}}$ ) are stable. When changing the clock frequency, stop the video clock for  $5\mu\text{s}$ , apply the clock at the new frequency, then restart the serial link or toggle SEREN. On-the-fly changes in clock frequency are possible if the new frequency is immediately stable and without glitches. The reverse control channel remains unavailable for  $500\mu\text{s}$  after serial link start or stop. When using the UART interface, limit on-the-fly changes in  $f_{\text{UART}}$  to factors of less than 3.5 at a time to ensure that the device recognizes the UART sync pattern. For example, when lowering the UART frequency from 1Mbps to 100kbps, first send data at 333kbps then at 100kbps for reduction ratios of 3 and 3.333, respectively.

### Fast Detection of Loss of Synchronization

A measure of link quality is the recovery time from loss of synchronization. The host can be quickly notified of loss-of-lock by connecting the deserializer's LOCK output to the GPI input. If other sources use the GPI input, such as a touch-screen controller, the  $\mu$ C can implement a routine to distinguish between interrupts from loss-of-sync and normal interrupts. Reverse control-channel communication does not require an active forward link to operate and accurately tracks the LOCK status of the GMSL link. LOCK asserts for video link only and not for the configuration link.

### Providing a Frame Sync (Camera Applications)

The GPI/GPO provide a simple solution for camera applications that require a frame sync signal from the ECU (e.g., surround-view systems). Connect the ECU frame sync signal to the GPI input, and connect GPO output to the camera frame sync input. GPI/GPO has a typical delay of 275 $\mu$ s (350 $\mu$ s max). Skew between multiple GPI/GPO channels is 115 $\mu$ s max. If a lower skew signal is required, connect the camera's frame sync input to one of the deserializer's GPIOs and use an I<sup>2</sup>C broadcast write command to change the GPIO output state. This has a maximum skew of 1.5 $\mu$ s, independent from the used I<sup>2</sup>C bit rate.

### Software Programming of the Device Addresses

The serializers and deserializers have programmable device addresses. This allows multiple GMSL devices, along with I<sup>2</sup>C peripherals, to coexist on the same control channel. The serializer device address is in register 0x00 of each device, while the deserializer device address is in register 0x01 of each device. To change a device address, first write to the device whose address changes (register

0x00 of the serializer for serializer device address change, or register 0x01 of the deserializer for deserializer device address change). Then write the same address into the corresponding register on the other device (register 0x00 of the deserializer for serializer device address change, or register 0x01 of the serializer for deserializer device address change).

### 3-Level Configuration Inputs

ADD0[1:0], CX/TP and BWS are 3-level inputs that control the serial interface configuration and power-up defaults. Connect 3-level inputs through a pullup resistor to IOVDD to set a high level, a pulldown resistor to GND to set a low level, or open to set a mid level. For digital control, use three-state logic to drive the 3-level logic input.

### Configuration Blocking

The deserializers can block changes to registers. Set CFGBLOCK to make registers 0x00 to registers 0x1F as read only. Once set, the registers remain blocked until the supplies are removed or until PWDN is low.

### Compatibility with Other GMSL Devices

The deserializers are designed to pair with the MAX9275–MAX9281 serializers, but interoperate with any GMSL serializers. See [Table 20](#) for operating limitations.

### Key Memory

Each device has a unique HDCP key set that is stored in secure nonvolatile memory (NVM). The HDCP key set consists of 40 56-bit private keys and one 40-bit public key. The NVM is qualified for automotive applications.

### HS/VS/DE Inversion

The deserializer uses an active-high HS, VS, and DE for encoding and HDCP encryption. Set INVHSYNC, INVVSYNC, and INVDE in the serializer (registers 0x0D,

**Table 20. MAX9278/MAX9282 Feature Compatibility**

MAX9278/MAX9282 FEATURE	GMSL SERIALIZER
HDCP (MAX9282 only)	If feature not supported in serializer, must not be turned on in the MAX9282.
High-bandwidth mode	If feature not supported in serializer, must only use 24-bit and 32-bit modes.
I <sup>2</sup> C to I <sup>2</sup> C	If feature not supported in serializer, must use UART-to-I <sup>2</sup> C or UART-to-UART mode.
Coax	If feature not supported in serializer, must connect unused serial output through 200nF and 50 $\Omega$ in series to V <sub>DD</sub> and set the reverse control-channel amplitude to 100mV.
High-immunity control channel	If feature not supported in serializer, must use the legacy reverse control-channel mode.
TDM encoding	If feature not supported in serializer, must use I <sup>2</sup> S encoding (with 50% WS duty cycle), if supported.
I <sup>2</sup> S encoding	If feature not supported in serializer, must disable I <sup>2</sup> S in the MAX9278/MAX9282.

0x0E) to invert active-low input signals for use with the GMSL devices. Set INVHSYNC, INVVSYNC, and INVDE in the deserializer (register 0x0F, 0x14) to output active-low signals for use with downstream devices.

### WS/SCK Inversion

The deserializer uses standard polarities for I<sup>2</sup>S. Set INVWS, INVSCK in the serializer (register 0x1B) to invert opposite polarity signals for use with the GMSL devices. Set INVWS, INVSCK in the deserializer (register 0x1D) to output reverse-polarity signals for downstream use.

### GPIOs

The deserializers have two open-drain GPIOs available when not used for HDCP purposes (see the [Notification of Start of Authentication and Enable of Encryption to Downstream Links](#) section), GPIO1OUT and GPIO0OUT (0x06, D3 and D1) set the output state of the GPIOs. Setting the GPIO output bits to 0 low pulls the output low, while setting the bits to 1 leaves the output undriven, and pulled high through internal/external pullup resistors. The GPIO input buffers are always enabled. The input states are stored in GPIO1 and GPIO0 (0x06, D2 and D0). Set GPIO1OUT/GPIO0OUT to 1 when using GPIO1/GPIO0 as an input.

### Internal Input Pulldowns

The control and configuration inputs (except 3-level inputs) include a pulldown resistor to GND. External pulldown resistors are not needed.

### Choosing I<sup>2</sup>C/UART Pullup Resistors

I<sup>2</sup>C and UART open-drain lines require a pullup resistor to provide a logic-high level. There are tradeoffs between power dissipation and speed, and a compromise may be required when choosing pullup resistor values. Every device connected to the bus introduces some capacitance even when the device is not in operation. I<sup>2</sup>C specifies 300ns rise times (30% to 70%) for fast mode, which is defined for data rates up to 400kbps (see the I<sup>2</sup>C specifications in the [AC Electrical Characteristics](#) table

for details). To meet the fast-mode rise-time requirement, choose the pullup resistors so that rise time  $t_R = 0.85 \times R_{PULLUP} \times C_{BUS} < 300\text{ns}$ . The waveforms are not recognized if the transition time becomes too slow. The device supports I<sup>2</sup>C/UART rates up to 1Mbps.

### AC-Coupling

AC-coupling isolates the receiver from DC voltages up to the voltage rating of the capacitor. Capacitors at the serializer output and at the deserializer input are needed for proper link operation and to provide protection if either end of the cable is shorted to a battery. AC-coupling blocks low-frequency ground shifts and low-frequency common-mode noise.

### Selection of AC-Coupling Capacitors

Voltage droop and the digital sum variation (DSV) of transmitted symbols cause signal transitions to start from different voltage levels. Because the transition time is fixed, starting the signal transition from different voltage levels causes timing jitter. The time constant for an AC-coupled link needs to be chosen to reduce droop and jitter to an acceptable level. The RC network for an AC-coupled link consists of the CML/coax receiver termination resistor ( $R_{TR}$ ), the CML/coax driver termination resistor ( $R_{TD}$ ), and the series AC-coupling capacitors (C). The RC time constant for four equal-value series capacitors is  $(C \times (R_{TD} + R_{TR}))/4$ .  $R_{TD}$  and  $R_{TR}$  are required to match the transmission line impedance (usually 100Ω differential, 50Ω single ended). This leaves the capacitor selection to change the system time constant. Use at 0.22μF (using legacy reverse control channel), 47nF (using high-immunity reverse control channel), or larger high-frequency surface-mount ceramic capacitors, with sufficient voltage rating to withstand a short to battery, to pass the lower speed reverse control-channel signal. Use capacitors with a case size less than 3.2mm x 1.6mm to have lower parasitic effects to the high-speed signal.

**Power-Supply Circuits and Bypassing**

The deserializers use an AVDD and DVDD of 3.0V to 3.6V. All single-ended inputs and outputs except for the serial input derive power from an IOVDD of 1.7V to 3.6V, which scale with IOVDD. Proper voltage-supply bypassing is essential for high-frequency circuit stability.

**Power-Supply Table**

HDPCP operation (MAX9282 only) draws additional current. This is shown in [Table 21](#).

**Cables and Connectors**

Interconnect for CML typically has a differential impedance of 100Ω. Use cables and connectors that have matched differential impedance to minimize impedance discontinuities. Coax cables typically have a characteristic

impedance of 50Ω; contact the factory for 75Ω operation). [Table 22](#) lists the suggested cables and connectors used in the GMSL link.

**Board Layout**

Separate LVCMOS logic signals and CML/coax high-speed signals to prevent crosstalk. Use a four-layer PCB with separate layers for power, ground, CML/coax, and LVCMOS logic signals. Layout PCB traces close to each other for a 100Ω differential characteristic impedance for STP. The trace dimensions depend on the type of trace used (microstrip or stripline). Note that two 50Ω PCB traces do not have 100Ω differential impedance when brought close together—the impedance goes down when the traces are brought closer. Use a 50Ω trace for the single-ended output when driving coax.

**Table 21. Additional Supply Current from HDPCP (MAX9282 Only)**

$f_{TXCLKOUT}$ (MHz)	MAXIMUM HDPCP CURRENT (mA)
16.6	6
33.3	9
36.6	9
66.6	12
104	18

**Table 22. Suggested Connectors and Cables for GMSL**

VENDOR	CONNECTOR	CABLE	TYPE
Rosenberger	59S2AX-400A5-Y	RG174	Coax
Rosenberger	D4S10A-40ML5-Z	Dacar 538	STP
Nissei	GT11L-2S	F-2WME AWG28	STP
JAE	MX38-FF	A-BW-Lxxxxx	STP

Route the PCB traces for differential CML channel in parallel to maintain the differential characteristic impedance. Avoid vias. Keep PCB traces that make up a differential pair equal length to avoid skew within the differential pair.

**ESD Protection**

ESD tolerance is rated for Human Body Model, IEC 61000-4-2, and ISO 10605. The ISO 10605 and IEC 61000-4-2 standards specify ESD tolerance for electronic systems. The serial link inputs are rated for ISO 10605 ESD protection and IEC 61000-4-2 ESD protection. All pins are tested for the Human Body Model. The Human Body Model discharge components are  $C_S = 100\text{pF}$  and  $R_D = 1.5\text{k}\Omega$  (Figure 46). The IEC 61000-4-2 discharge components are  $C_S = 150\text{pF}$  and  $R_D = 330\Omega$  (Figure 47). The ISO 10605 discharge components are  $C_S = 330\text{pF}$  and  $R_D = 2\text{k}\Omega$  (Figure 48).



Figure 46. Human Body Model ESD Test Circuit



Figure 47. IEC 61000-4-2 Contact Discharge ESD Test Circuit



Figure 48. ISO 10605 Contact Discharge ESD Test Circuit



**Table 23. Register Table**

REGISTER ADDRESS	BITS	NAME	VALUE	FUNCTION	DEFAULT VALUE
0x00	D[7:1]	SERID	XXXXXXX	Serializer device address (power-up default value depends on latched address pin level)	XX00XX0
	D0	—	0	Reserved	0
0x01	D[7:1]	DESID	XXXXXXX	Deserializer device address (power-up default value depends on latched address pin level)	XX01XXX
	D0	CFGBLOCK	0 1	Normal operation Registers 0x00 to 0x1F are read only	0
0x02	D[7:6]	SS	00	No spread spectrum. <b>Power-up default when SSEN = low.</b>	00
			01	±2% spread spectrum. <b>Power-up default when SSEN = high.</b>	
			10	No spread spectrum	
			11	±4% spread spectrum	
	D5	AUDIOMODE	0	WS, SCK configured as output (deserializer sourced clock)	0
			1	WS, SCK configured as input (system sourced clock)	
	D4	AUDIOEN	0	Disable I <sup>2</sup> S/TDM channel	1
			1	Enable I <sup>2</sup> S/TDM channel	
	D[3:2]	PRNG	00	12.5MHz to 25MHz pixel clock	11
			01	25MHz to 50MHz pixel clock	
			10	50MHz to 104MHz pixel clock	
			11	Automatically detect the pixel clock range	
D[1:0]	SRNG	00	0.5 to 1Gbps serial-data rate	11	
		01	1 to 2Gbps serial-data rate		
		10	2 to 3.12Gbps serial-data rate		
		11	Automatically detect serial-data rate		
0x03	D[7:6]	AUTOFM	00	Calibrate spread modulation rate only once after locking	00
			01	Calibrate spread modulation rate every 2ms after locking	
			10	Calibrate spread modulation rate every 16ms after locking	
			11	Calibrate spread modulation rate every 256ms after locking	
	D5	—	0	Reserved	0
	D[4:0]	SDIV	00000	Auto calibrate sawtooth divider	00000
XXXXX			Manual SDIV setting. See the <i>Manual Programming of the Spread-Spectrum Divider</i> section.		

**Table 23. Register Table (continued)**

REGISTER ADDRESS	BITS	NAME	VALUE	FUNCTION	DEFAULT VALUE
0x04	D7	LOCKED	0	LOCK output is low	0 (read only)
			1	LOCK output is high	
	D6	OUTENB	0	Enable CNTL and I <sup>2</sup> S outputs	0
			1	Disable CNTL and I <sup>2</sup> S outputs	
	D5	PRBSEN	0	Disable PRBS test	0
			1	Enable PRBS test	
	D4	SLEEP	0	Normal mode (power-up default value depends on CDS and MS pin value at power-up)	0, 1
			1	Activate sleep mode (power-up default value depends on CDS and MS pin value at power-up)	
	D[3:2]	INTTYPE	00	Deserializer control channel uses UART-to-I <sup>2</sup> C when I <sup>2</sup> CSEL = 0	01
			01	Deserializer control channel uses UART-to UART when I <sup>2</sup> CSEL = 0	
			10, 11	Deserializer control channel disabled	
	D1	REVCCEN	0	Disable reverse control channel to serializer (sending)	1
1			Enable reverse control channel to serializer (sending)		
D0	FWDCCEN	0	Disable forward control channel from serializer (receiving)	1	
		1	Enable forward control channel from serializer (receiving)		
0x05	D7	I <sup>2</sup> CMETHOD	0	I <sup>2</sup> C conversion sends the register address when converting UART to I <sup>2</sup> C	0
			1	Disable sending of I <sup>2</sup> C register address when converting UART to I <sup>2</sup> C (command-byte-only mode)	
	D[6:5]	HPFTUNE	00	7.5MHz equalizer highpass filter cutoff frequency	01
			01	3.75MHz equalizer highpass filter cutoff frequency	
			10	2.5MHz equalizer highpass filter cutoff frequency	
			11	1.87MHz equalizer highpass filter cutoff frequency	
	D4	PDEQ	0	Enable equalizer	0
			1	Disable equalizer	
	D[3:0]	EQTUNE	0000	2.1dB equalizer boost gain	0100, 1001
			0001	2.8dB equalizer boost gain	
			0010	3.4dB equalizer boost gain	
			0011	4.2dB equalizer boost gain	
			<b>0100</b>	5.2dB equalizer boost gain. <b>Power-up default when SSEN = high.</b>	
			0101	6.2dB equalizer boost gain	
			0110	7dB equalizer boost gain	
0111			8.2dB equalizer boost gain		
1000			9.4dB equalizer boost gain		
<b>1001</b>			10.7dB equalizer boost gain. <b>Power-up default when SSEN = low.</b>		
1010			11.7dB equalizer boost gain		
1011			13dB equalizer boost gain		
11XX	Do not use				

Table 23. Register Table (continued)

REGISTER ADDRESS	BITS	NAME	VALUE	FUNCTION	DEFAULT VALUE
0x06	D7	PRBSTYPE	0	Deserializer uses standard PRBS test	0
			1	Deserializer uses MAX9271/MAX9273-compatible PRBS test	
	D6	AUTORST	0	No automatic reset of error registers and outputs	0
			1	Automatically reset DECERR register 1 $\mu$ s after ERR asserts	
	D5	DISGPI	0	Enable GPI to GPO signal transmission to serializer	0
			1	Disable GPI to GPO signal transmission to serializer	
	D4	GPIIN	0	GPI input is low	0 (read only)
			1	GPI input is high	
	D3	GPIO1OUT	0	Set GPIO1 to low	1
			1	Set GPIO1 to high	
	D2	GPIO1IN	0	GPIO1 input is low	0 (read only)
			1	GPIO1 input is high	
D1	GPIO0OUT	0	Set GPIO0 to low	1	
		1	Set GPIO0 to high		
D0	GPIO0IN	0	GPIO0 input is low	0 (read only)	
		1	GPIO0 input is high		
0x07	D[7:0]	—	01010100	Reserved	01010100
0x08	D[7:3]	—	00110	Reserved	00110
	D2	DISDEFILT	0	Enable DE glitch filter. <b>Power up default when BWS = low or high.</b>	0, 1
			1	Disable DE glitch filter. <b>Power-up default when BWS = open.</b>	
	D1	DISVSFILT	0	Enable VS glitch filter. <b>Power-up default when BWS = low or high.</b>	0, 1
			1	Disable VS glitch filter. <b>Power-up default when BWS = open.</b>	
	D0	DISHSFILT	0	Enable HS glitch filter. <b>Power-up default BwhnWS = low or high.</b>	0, 1
1			Disable HS glitch filter. <b>Power-up default when BWS = open.</b>		
0x09	D[7:0]	—	11001000	Reserved	11001000
0x0A	D[7:0]	—	00010XXX	Reserved	00010XXX
0x0B	D[7:0]	—	00100000	Reserved	00100000
0x0C	D[7:0]	ERRTHR	XXXXXXXX	Error threshold for decoding errors	00000000
0x0D	D[7:0]	DECERR	XXXXXXXX	Decoding error counter	00000000 (read only)
0x0E	D[7:0]	PRBSERR	XXXXXXXX	PRBS error counter	00000000 (read only)

Table 23. Register Table (continued)

REGISTER ADDRESS	BITS	NAME	VALUE	FUNCTION	DEFAULT VALUE
0x0F	D[7:3]	—	00000	Reserved	00000
	D2	INVDE	0	No DE inversion at the output	0
			1	Invert DE at the output	
	D1	DISRWAKE	0	Enable remote wake-up	0
			1	Disable remote wake-up	
	D0	INTOUT	0	Drive INTOUT low	0
1			Drive INTOUT high		
0x10	D[7:0]	—	XXXXXXXX	Reserved	(Read only)
0x11	D7	REVFAST	0	High-immunity reverse control-channel mode uses 500kbps bit rate	0
			1	High-immunity reverse control-channel mode uses 1Mbps bit rate	
	D[6:0]	—	0100010	Reserved	0100010
0x12	D7	MCLKSRC	0	MCLK derived from TXCLKOUT (see Table 6)	0
			1	MCLK derived from internal oscillator	
	D[6:0]	MCLKDIV	0000000 XXXXXXXX	MCLK disabled MCLK divider	0000000
0x13	D[7:0]	—	0X010000	Reserved	0X010000
0x14	D7	INVVSYNC	0	No VS inversion at the output	0
			1	Invert VS at the output	
	D6	INVHSYNC	0	No HS inversion at the output	0
			1	Invert HS at the output	
	D5	FORCELVDS	0	Normal LVDS output operation	0
			1	LVDS output forced low	
	D4	DCS	0	Normal CMOS output driver current	0
			1	Boosted CMOS output driver current	
	D3	DISCNTL	0	Serial-data bit 27 mapped to CNTL1 (when BWS = high)	1
			1	CNTL1 forced low (when BWS = high)	
	D2	DISRES	0	Serial-data bit 27 mapped to RES bit (when BWS = high)	0
			1	RES bit forced low (when BWS = high)	
	D[1:0]	ILVDS	00	1.75mA LVDS driver current	01
			01	3.5mA LVDS driver current	
10			5.25mA LVDS driver current		
11			7mA LVDS driver current		

Table 23. Register Table (continued)

REGISTER ADDRESS	BITS	NAME	VALUE	FUNCTION	DEFAULT VALUE
0x15	D7	AUTOINT	0	INTOUT pin output controlled by INTOUT bit above	1
			1	Writes to any AVINFO bytes sets INTOUT to high. Reads to any AVINFO bytes sets INTOUT to low.	
	D6	HVTREN	0	Disable HS/VS tracking (power-up default value depends on state of BWS input value at power-up)	0, 1
			1	Enable HS/VS tracking (power-up default value depends on state of BWS input value at power-up)	
	D5	DETREN	0	Disable DE tracking (power-up default value depends on state of BWS input value at power-up)	0, 1
			1	Enable DE tracking (power-up default value depends on state of BWS input value at power-up)	
	D4	HVTRMODE	0	Partial periodic HS/VS and DE tracking	1
			1	Partial and full periodic HS/VS and DE tracking	
	D[3:2]	—	00	Reserved	00
	D1	MCLKWS	0	MCLK output operates normally	0
1			WS is output from MCLK (MCLK mirrors WS)		
D0	MCLKPIN	0	MCLK output on CNTL2 (when OEN = low)	0	
		1	MCLK output on CNTL0 (when OEN = low)		
0x16	D7	HIGHIMM	0	Legacy reverse control-channel mode (power-up default value depends on SD/HIM at power-up)	0, 1
			1	High-immunity reverse control-channel mode (power-up default value depends on SD/HIM at power-up)	
	D[6:0]	—	1011010	Reserved	1011010
0x17	D[7:0]	—	0XXXXXXXX	Reserved	00000000
0x18	D[7:1]	I2CSRCA	XXXXXXXX	I <sup>2</sup> C address translator source A	00000000
	D0	—	0	Reserved	0
0x19	D[7:1]	I2CDSTA	XXXXXXXX	I <sup>2</sup> C address translator destination A	00000000
	D0	—	0	Reserved	0
0x1A	D[7:1]	I2CSRCA	XXXXXXXX	I <sup>2</sup> C address translator source B	00000000
	D0	—	0	Reserved	0
0x1B	D[7:1]	I2CDSTB	XXXXXXXX	I <sup>2</sup> C address translator destination B	00000000
	D0	—	0	Reserved	0

**Table 23. Register Table (continued)**

REGISTER ADDRESS	BITS	NAME	VALUE	FUNCTION	DEFAULT VALUE
0x1C	D7	I2CLOCKACK	0	Acknowledge not generated when forward channel is not available	1
			1	I2C-to-I2C slave generates local acknowledge when forward channel is not available	
	D[6:5]	I2CSLVSH	00	352ns/117ns I2C setup/hold time	01
			01	469ns/234ns I2C setup/hold time	
			10	938ns/352ns I2C setup/hold time	
			11	1046ns/469ns I2C setup/hold time	
	D[4:2]	I2CMSTBT	000	8.47kbps (typ) I2C-to-I2C master bit-rate setting	101
			001	28.3kbps (typ) I2C-to-I2C master bit-rate setting	
			010	84.7kbps (typ) I2C-to-I2C master bit-rate setting	
			011	105kbps (typ) I2C-to-I2C master bit-rate setting	
			100	173kbps (typ) I2C-to-I2C master bit-rate setting	
			101	339kbps (typ) I2C-to-I2C master bit-rate setting	
			110	533kbps (typ) I2C-to-I2C master bit-rate setting	
			111	837kbps (typ) I2C-to-I2C master bit-rate setting	
	D[1:0]	I2CSLVTO	00	64µs (typ) I2C-to-I2C slave remote timeout	10
			01	256µs (typ) I2C-to-I2C slave remote timeout	
10			1024µs (typ) I2C-to-I2C slave remote timeout		
11			No I2C-to-I2C slave remote timeout		
0x1D	D[7:6]	—	00	Reserved	00
	D5	DESEL	0	Normal DE operation	0
			1	HS copied to DE	
	D[4:3]	HVSRC	00	D18/D19 used for HS/VS (normal operation)	00
			01	D14/D15 used for HS/VS (D[19:16] shifted to D[17:14]), for use with the MAX9271	
			1X	D0/D1 used for HS/VS (D[19:2] shifted to D[17:0]), for use with the MAX9271/73 with HV inversion	
	D2	AUDUFBEH	0	Audio FIFO repeats last audio word when FIFO is empty	0
			1	Audio FIFO outputs all zeroes when FIFO is empty	
	D1	INVSK	0	Do not invert SCK at output	0
			1	Invert SCK at output	
	D0	INVWS	0	Do not invert WS at output	0
			1	Invert WS at output	

Table 23. Register Table (continued)

REGISTER ADDRESS	BITS	NAME	VALUE	FUNCTION	DEFAULT VALUE
0x1E	D[7:0]	ID	0010XX00	Device identifier (MAX9278 = 0x24) (MAX9282 = 0x28)	0010XX00 (read only)
0x1F	D[7:5]	—	000	Reserved	000 (read only)
	D4	CAPS	0	Not HDCP capable (MAX9278)	(Read only)
			1	HDCP capable (MAX9282)	
D[3:0]	REVISION	XXXX	Device revision	(Read only)	
0x40 to 0x59	D[7:0]	AVINFO	XXXXXXXX	Video/audio format/status/information bytes	All zeroes
0x77	D[7:0]	—	XXXXXXXX		(Read only)
0x78	D[7:0]	AUDOUOPER	XXXXXXXX	Audio FIFO last overflow/underflow period (AUDIOMODE = 1 only)	(Read only)
0x79	D7	AUDOU	0	Audio FIFO is in underflow (AUDIOMODE = 1 only)	(Read only)
			1	Audio FIFO is in overflow (AUDIOMODE = 1 only)	
	D[6:0]	—	0000XXX	Reserved	0000XXX (read only)
0x7B	D[7:0]	LUTADDR	XXXXXXXX	LUT start address for write and read	00000000
0x7C	D[7:5]	—	000	Reserved	000
	D4	EN4THLANE	0	Normal operation	0
			1	TXOUT3_ enabled (when BWS = 0)	
	D3	LUTPROG	0	Disable LUT write and read	0
			1	Enable LUT write and read	
	D2	BLULUTEN	0	Disable blue LUT	0
			1	Enable blue LUT	
	D1	GRNLUTEN	0	Disable green LUT	0
			1	Enable green LUT	
	D0	REDLUTEN	0	Disable red LUT	0
1			Enable red LUT		
0x7D	D[7:0]	REDLUT	XXXXXXXX	Red LUT value (see Table 12)	00000000
0x7E	D[7:0]	GREENLUT	XXXXXXXX	Green LUT value (see Table 12)	00000000
0x7F	D[7:0]	BLUELUT	XXXXXXXX	Blue LUT value (see Table 12)	00000000

X = Don't care

**Table 24. HDCP Register Table (MAX9282 Only)**

REGISTER ADDRESS	SIZE (Bytes)	NAME	READ/ WRITE	FUNCTION	DEFAULT VALUE (hex)
0X80 to 0x84	5	BKSV	Read only	HDCP receiver KSV	(Read only)
0X85 to 0x86	2	RI'	Read only	Link verification response	(Read only)
0X87	1	PJ'	Read only	Enhanced link verification response	(Read only)
0X88 to 0x8F	8	AN	Read/write	Session random number	0x0000000000000000
0X90 to 0x94	5	AKSV	Read/write	HDCP transmitter KSV	0x0000000000
0x95	1	BCTRL	Read/write	D7 = PD_HDCP 1 = Power down HDCP circuits 0 = HDCP circuits normal	0x00
				D[6:4] = Reserved	
				D3 = GPIO1_FUNCTION 1 = GPIO1 mirrors AUTH_STARTED 0 = Normal GPIO1 operation	
				D2 = GPIO0_FUNCTION 1 = GPIO0 mirrors ENCRYPTION_ENABLE 0 = Normal GPIO0 operation	
				D1 = AUTH_STARTED 1 = Authentication started (triggered by write to AKSV) 0 = Authentication not started	
				D0 = ENCRYPTION_ENABLE 1 = Enable encryption 0 = Disable encryption	
0x96	1	BSTATUS	Read/write	D[7:2] = Reserved	0x00
				D1 = NEW_DEV_CONN 1 = Set to 1 if a new connected device is detected 0 = Set to 0 if no new device is connected	
				D0 = KSV_LIST_READY 1 = Set to 1 if KSV list and BINFO is ready 0 = Set to 0 if KSV list or BINFO is not ready	
0x97	1	BCAPS	Read/write	D[7:1] = Reserved	0x00
				D0 = REPEATER 1 = Set to one if device is a repeater 0 = Set to zero if device is not a repeater	
0x98 to 0x9F	8	—	Read only	Reserved	0x0000000000000000 (Read only)
0XA0 to 0xA3	4	V'.H0	Read/write	H0 part of SHA-1 hash value	0x00000000
0XA4 to 0xA7	4	V'.H1	Read/write	H1 part of SHA-1 hash value	0x00000000
0XA8 to 0xAB	4	V'.H2	Read/write	H2 part of SHA-1 hash value	0x00000000
0XAC to 0xAF	4	V'.H3	Read/write	H3 part of SHA-1 hash value	0x00000000
0XB0 to 0xB3	4	V'.H4	Read/write	H4 part of SHA-1 hash value	0x00000000



**Table 24. HDCP Register Table (MAX9282 Only) (continued)**

REGISTER ADDRESS	SIZE (Bytes)	NAME	READ/WRITE	FUNCTION	DEFAULT VALUE (hex)
0xB4 to 0xB5	2	BINFO	Read/write	D[15:12] = Reserved	0x0000
				D11 = MAX_CASCADE_EXCEEDED 1 = Set to one if more than seven cascaded devices attached 0 = Set to zero if seven or fewer cascaded devices attached	
				D[10:8] = DEPTH Depth of cascaded devices	
				D7 = MAX_DEVS_EXCEEDED 1 = Set to one if more than 14 devices attached 0 = Set to zero if 14 or fewer devices attached	
				D[6:0] = DEVICE_COUNT Number of devices attached	
0xB6	1	GPMEM	Read/write	General-purpose memory byte	0x00
0xB7 to 0xB9	3	—	Read only	Reserved	0x000000
0xBA to 0xFF	70	KSV_LIST	Read/write	List of KSVs downstream repeaters and receivers (maximum of 14 devices)	All zero

Typical Application Circuit



Ordering Information

PART	TEMP RANGE	PIN-PACKAGE	HDCP
MAX9278GGM/VY+	-40°C to +105°C	48 QFND-EP**	No
MAX9278GTM+	-40°C to +105°C	48 TQFN-EP**	No
MAX9278GTM/V+	-40°C to +105°C	48 TQFN-EP**	No
MAX9282GGM/VY+	-40°C to +105°C	48 QFND-EP**	Yes***
MAX9282GTM+	-40°C to +105°C	48 TQFN-EP**	Yes***
MAX9282GTM/V+	-40°C to +105°C	48 TQFN-EP**	Yes***

+Denotes a lead(Pb)-free/RoHS-compliant package.

\*\*EP = Exposed pad.

/V denotes an automotive qualified product.

\*\*\*HDCP parts require registration with Digital Content Protection, LLC.

Package Information

For the latest package outline information and land patterns (footprints), go to [www.maximintegrated.com/packages](http://www.maximintegrated.com/packages). Note that a "+", "#", or "-" in the package code indicates RoHS status only. Package drawings may show a different suffix character, but the drawing pertains to the package regardless of RoHS status.

Chip Information

PROCESS: CMOS

PACKAGE TYPE	PACKAGE CODE	OUTLINE NO.	LAND PATTERN NO.
48 QFND-EP	G4877Y+3	<a href="#">21-0585</a>	<a href="#">90-0457</a>
48 TQFN-EP	T4877+4	<a href="#">21-0144</a>	<a href="#">90-0130</a>

## Revision History

REVISION NUMBER	REVISION DATE	DESCRIPTION	PAGES CHANGED
0	2/14	Initial release	—
1	9/14	Added simplified diagram, renumbered figure and tables, clarified functions, corrected typos, and removed future product references	1, 2, 10–12, 15, 18, 20–50, 52, 59, 61, 63–74

For pricing, delivery, and ordering information, please contact Maxim Direct at 1-888-629-4642, or visit Maxim Integrated's website at [www.maximintegrated.com](http://www.maximintegrated.com).

*Maxim Integrated cannot assume responsibility for use of any circuitry other than circuitry entirely embodied in a Maxim Integrated product. No circuit patent licenses are implied. Maxim Integrated reserves the right to change the circuitry and specifications without notice at any time. The parametric values (min and max limits) shown in the Electrical Characteristics table are guaranteed. Other parametric values quoted in this data sheet are provided for guidance.*



Компания «ЭлектроПласт» предлагает заключение долгосрочных отношений при поставках импортных электронных компонентов на взаимовыгодных условиях!

Наши преимущества:

- Оперативные поставки широкого спектра электронных компонентов отечественного и импортного производства напрямую от производителей и с крупнейших мировых складов;
- Поставка более 17-ти миллионов наименований электронных компонентов;
- Поставка сложных, дефицитных, либо снятых с производства позиций;
- Оперативные сроки поставки под заказ (от 5 рабочих дней);
- Экспресс доставка в любую точку России;
- Техническая поддержка проекта, помощь в подборе аналогов, поставка прототипов;
- Система менеджмента качества сертифицирована по Международному стандарту ISO 9001;
- Лицензия ФСБ на осуществление работ с использованием сведений, составляющих государственную тайну;
- Поставка специализированных компонентов (Xilinx, Altera, Analog Devices, Intersil, Interpoint, Microsemi, Aeroflex, Peregrine, Syfer, Eurofarad, Texas Instrument, Miteq, Cobham, E2V, MA-COM, Hittite, Mini-Circuits, General Dynamics и др.);

Помимо этого, одним из направлений компании «ЭлектроПласт» является направление «Источники питания». Мы предлагаем Вам помощь Конструкторского отдела:

- Подбор оптимального решения, техническое обоснование при выборе компонента;
- Подбор аналогов;
- Консультации по применению компонента;
- Поставка образцов и прототипов;
- Техническая поддержка проекта;
- Защита от снятия компонента с производства.



#### Как с нами связаться

**Телефон:** 8 (812) 309 58 32 (многоканальный)

**Факс:** 8 (812) 320-02-42

**Электронная почта:** [org@eplast1.ru](mailto:org@eplast1.ru)

**Адрес:** 198099, г. Санкт-Петербург, ул. Калинина, дом 2, корпус 4, литера А.