

# 7000 series

## Rocker and paddle switches

*Distinctive features*

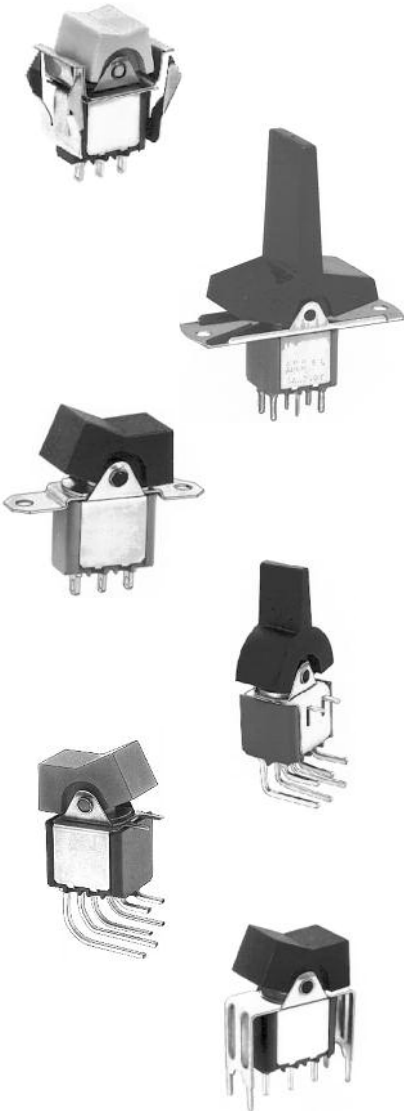

### ❑ **Wide variety of actuators**

Rockers and paddles in different sizes  
Available in 10 different colours  
Two bezel types

### ❑ **4 terminal types**

Solder lugs  
Quick-connect terminals  
Straight or right angle PC terminals

### ❑ **Many mounting styles for panel or PCB**

Snap-in  
By plate and screw  
PCB mounting with or without bracket

### ❑ **4 contact materials**

Silver and gold plated silver  
Gold plated and silver plated brass

### ❑ **8 electrical functions, maintained or momentary**

### ❑ **UL and CSA approved - for VDE refer to 57000**

The company reserves the right to change specifications without notice.

# 7000 series

## Rocker and paddle switches

### Specifications

#### ELECTRICAL SPECIFICATIONS

- Current/voltage rating with resistive load :

Contact	Maximum	Minimum	Level *
Silver A	4A 30VDC	50mA 10VDC	III and IV
Silver, gold plated AD	4A 30VDC Gold plating withstands up to 100mA 30VDC.	10mA 50mV 10 $\mu$ A 5V	I to IV
Brass, gold plated CD	0,4 VA at 20VAC or DC	10mA 50mV 10 $\mu$ A 5V	I and II

- For inductive, lamp or capacitive loads, consult factory. \* For details, see technical information, end of catalogue.
- Initial contact resistance : 10 m $\Omega$
- Insulation resistance : 1.000 M $\Omega$  min. at 500VDC
- Dielectric strength :
  - 1.000 Vrms 50 Hz min. between terminals
  - 1.500 Vrms 50 Hz min. between poles
  - 1.500 Vrms 50 Hz min. between terminals and frame
- Contact bounce : 2 ms max.
- Electrical life : 50.000 cycles at full load

#### MATERIALS

- Case : diallyphthalate (DAP) or high temperature plastic material (UL94-V0)
- Actuator : polyamide
- Housing : stainless steel or steel tin plated
- Bracket : steel, tin plated
- Contacts
  - A : silver
  - AD : silver, gold plated
  - CD : brass, gold plated
- Terminal seal : epoxy

#### GENERAL SPECIFICATIONS

- Low level or mechanical life : 100.000 cycles
- Panel thickness : 1 (.039) to 2,5 mm(.098)
- Operating temperature : -40°C to +85°C

#### AGENCY APPROVALS



3A 250VAC  
6A 125VAC

For VDE, refer to 57000 series.

**Availability** : consult factory for details of approved models.

**Marking** : to order switches marked UL or CSA, complete appropriate box of ordering format.

# 7000 series

## Rocker and paddle switches

### Overview

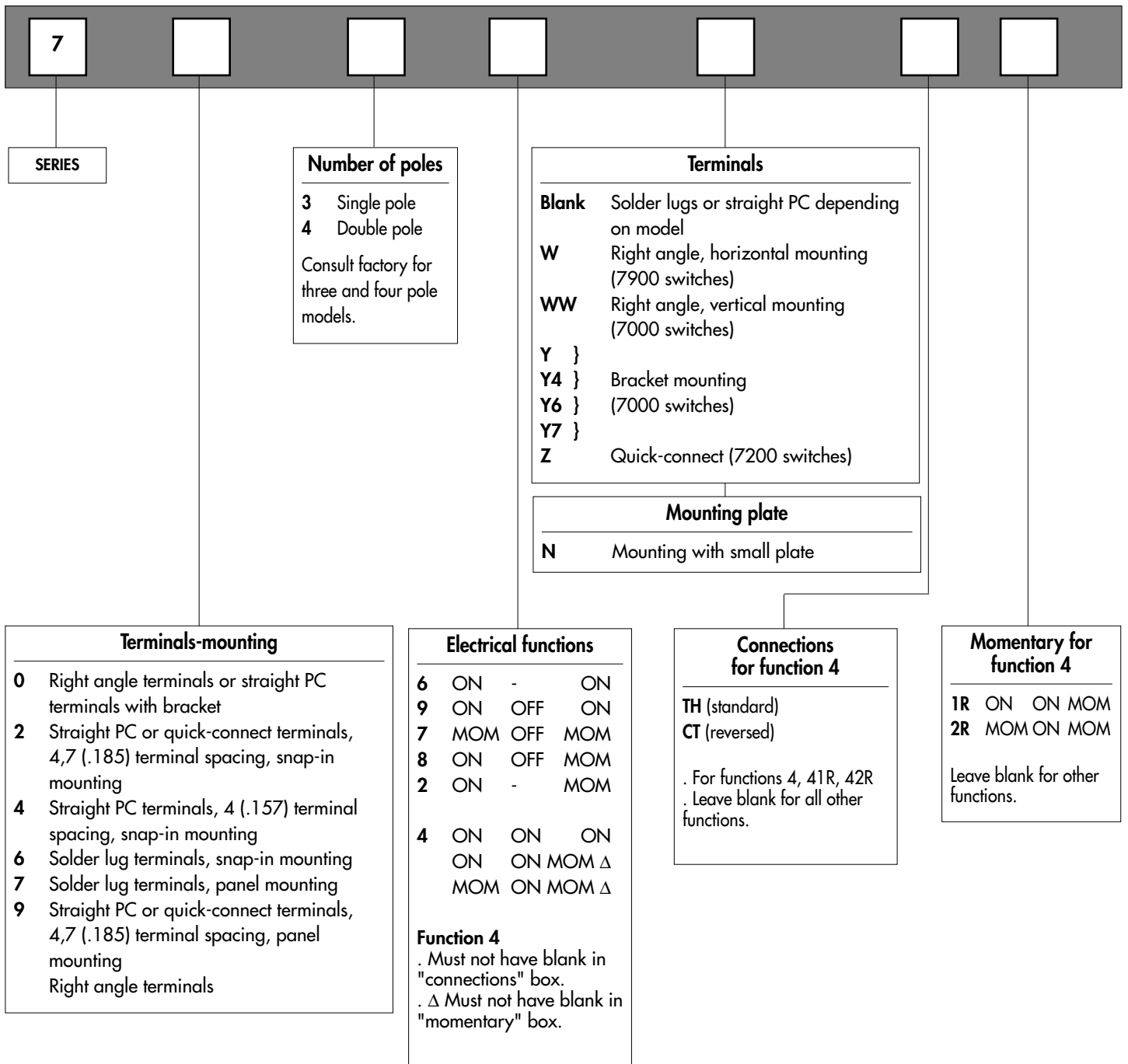

#### ABOUT THIS SERIES

On the following pages, you will find successively :

- model structure of switches
- options in the same order as in above chart

**Dimensions** : first dimensions are in mm while inches are shown as bracketed numbers.



**NOTICE** : please note that not all combinations of above numbers are available. Refer to the following pages for further information.



# 7000 series

## Rocker and paddle switches

Overview

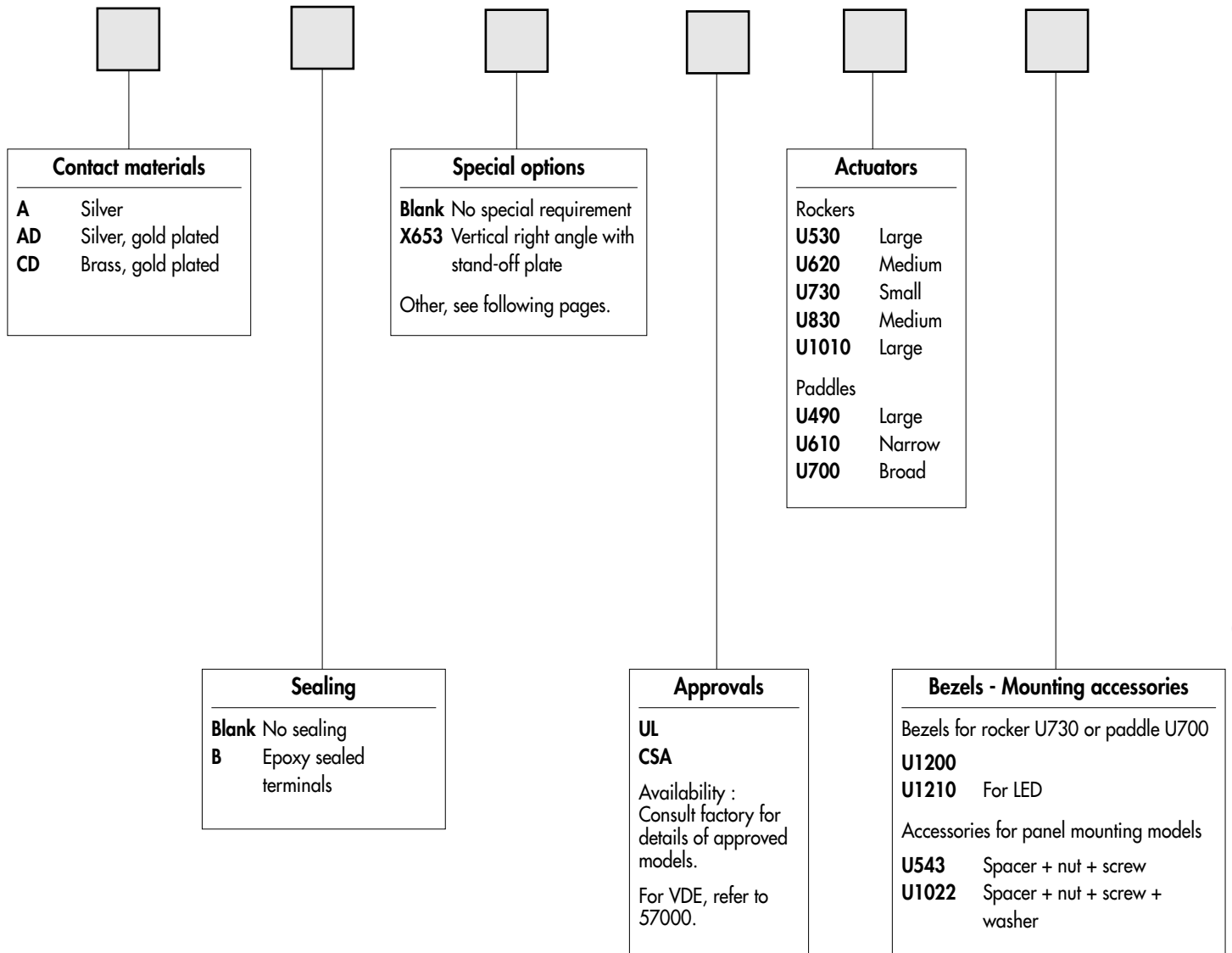

Packaging unit : 25 pieces.

# 7000 series

## Rocker and paddle switches

Snap-in mounting : 7600 - 7200 - 7400

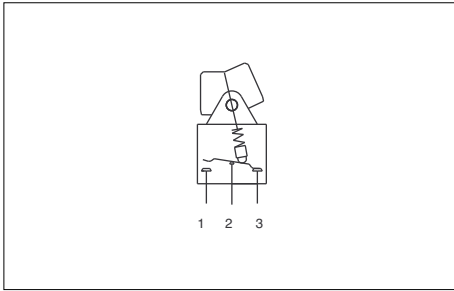

- Solder lug or straight PC terminals
- Epoxy sealing standard on models with straight PC terminals

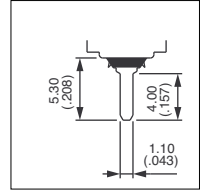
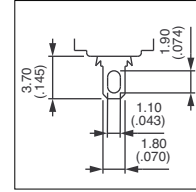

### MODEL STRUCTURE

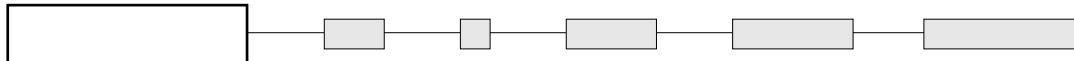

Shown with rocker U730 and bezel U1200

### Solder lug terminals : 7600



Single pole	Double pole
7636	7646
7639	7649
7637	7647
7638	7648
7632	7642
	7644*
	7644 1R*
	7644 2R*

III	II	I
2-3		1-2
5-6		4-5
ON	-	ON
ON	OFF	ON
MOM	OFF	MOM
ON	OFF	MOM
ON	-	MOM
ON	ON	ON
ON	ON	MOM
MOM	ON	MOM

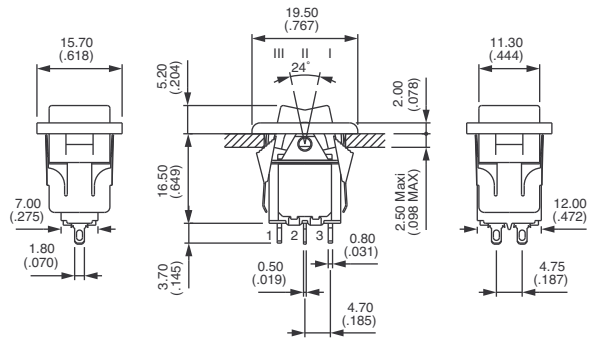

### Straight PC terminals - spacing 4,7 (.185) : 7200



Single pole	Double pole
7236 B	7246 B
7239 B	7249 B
7237 B	7247 B
7238 B	7248 B
7232 B	7242 B
	7244 B*
	7244 1R B*
	7244 2R B*

III	II	I
2-3		1-2
5-6		4-5
ON	-	ON
ON	OFF	ON
MOM	OFF	MOM
ON	OFF	MOM
ON	-	MOM
ON	ON	ON
ON	ON	MOM
MOM	ON	MOM

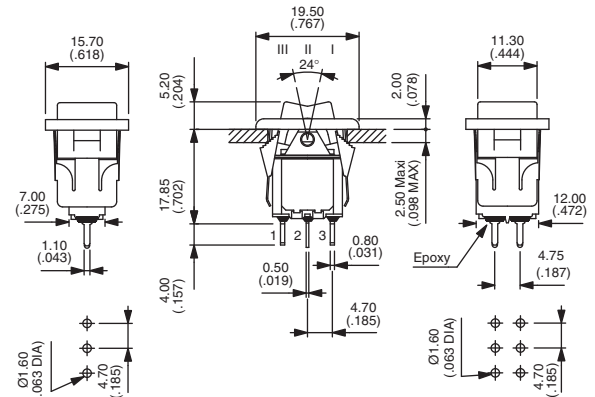

### Straight PC terminals - spacing 4 (.157) : 7400



Single pole	Double pole
7436 B	7446 B
7439 B	7449 B
7437 B	7447 B
7438 B	7448 B
7432 B	7442 B
	7444 B*
	7444 1R B*
	7444 2R B*

III	II	I
2-3		1-2
5-6		4-5
ON	-	ON
ON	OFF	ON
MOM	OFF	MOM
ON	OFF	MOM
ON	-	MOM
ON	ON	ON
ON	ON	MOM
MOM	ON	MOM

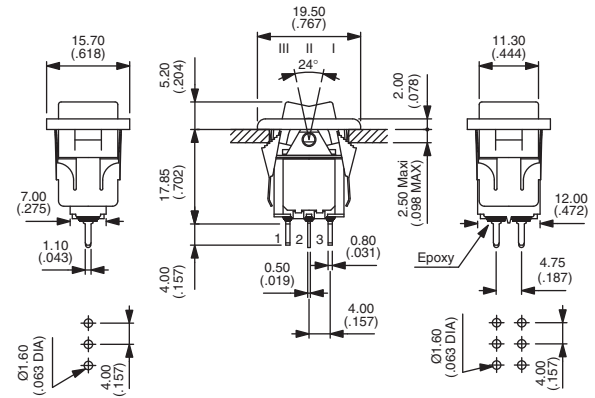

\* Function 4 : SP in DP case - specify CT or TH connections, see end of catalogue.



# 7000 series

## Rocker and paddle switches

Snap-in mounting : 7200Z

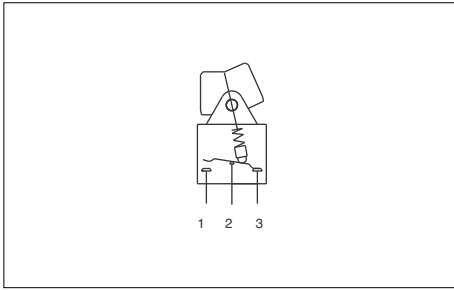

- Quick-connect terminals

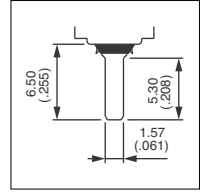

MODEL  
STRUCTURE

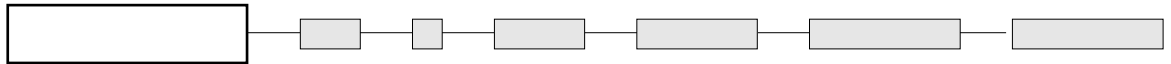

Shown with rocker U730 and bezel U1200

### Quick-connect terminals : 7200Z



Single pole	Double pole
7236Z	7246Z
7239Z	7249Z
7237Z	7247Z
7238Z	7248Z
7232Z	7242Z
	7244Z*
	7244Z 1R*
	7244Z 2R*

III	II	I
2-3		1-2
5-6		4-5
ON	-	ON
ON	OFF	ON
MOM	OFF	MOM
ON	OFF	MOM
ON	-	MOM
ON	ON	ON
ON	ON	MOM
MOM	ON	MOM

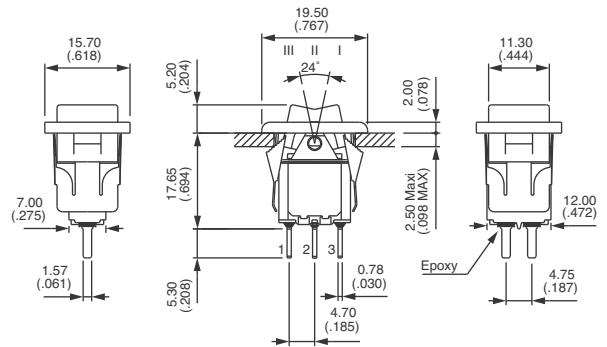

\* Function 4 : SP in DP case - specify CT or TH connections, see end of catalogue.

### PANEL CUT-OUT

7600 - 7200 - 7400 - 7200Z

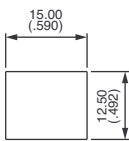

With or without bezel U1200

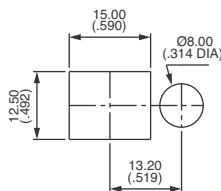

With bezel U1210

# 7000 series

## Rocker and paddle switches

Panel mounting : 7700 - 7900

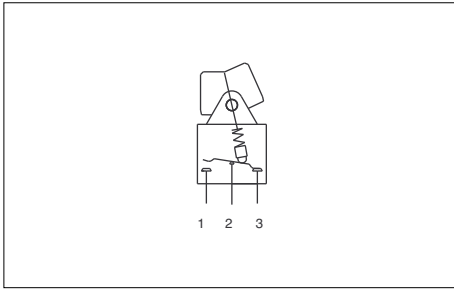

- Large rocker or paddle
- Solder lug or straight PC terminals
- Quick-connect terminals : on request
- Epoxy sealing standard on models with straight PC terminals

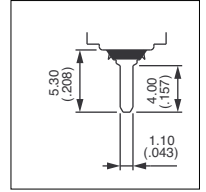
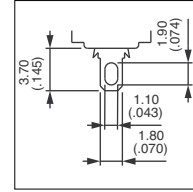

MODEL STRUCTURE

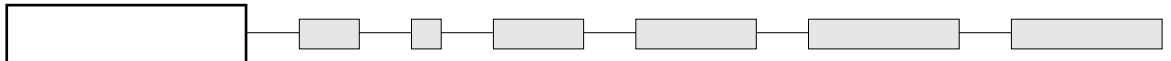

Shown with rocker U530

### Solder lug terminals : 7700

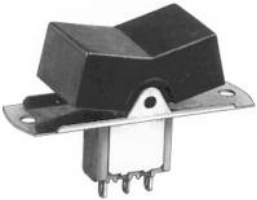

Single pole	Double pole
7736	7746
7739	7749
7737	7747
7738	7748
7732	7742
	7744*
	7744 1R*
	7744 2R*

III	II	I
2-3		1-2
5-6		4-5
ON	-	ON
ON	OFF	ON
MOM	OFF	MOM
ON	OFF	MOM
ON	-	MOM
ON	ON	ON
ON	ON	MOM
MOM	ON	MOM

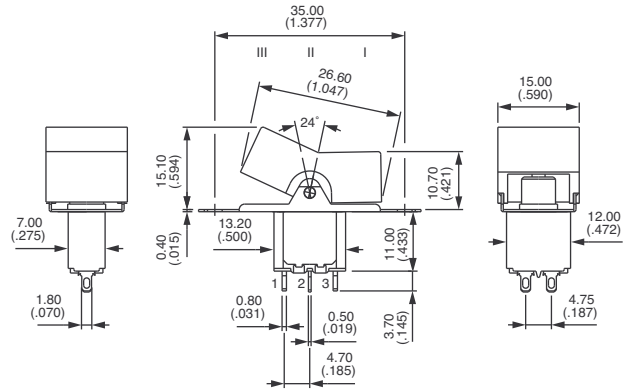

### Straight PC terminals : 7900



Single pole	Double pole
7936 B	7946 B
7939 B	7949 B
7937 B	7947 B
7938 B	7948 B
7932 B	7942 B
	7944 B*
	7944 1R B*
	7944 2R B*

III	II	I
2-3		1-2
5-6		4-5
ON	-	ON
ON	OFF	ON
MOM	OFF	MOM
ON	OFF	MOM
ON	-	MOM
ON	ON	ON
ON	ON	MOM
MOM	ON	MOM

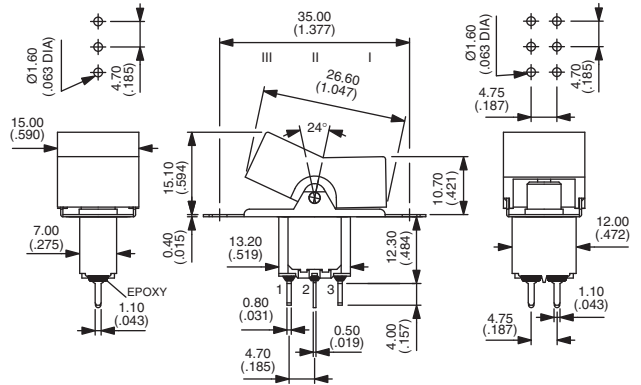

\* Function 4 : SP in DP case - specify CT or TH connections, see end of catalogue.

#### PANEL CUT-OUT

#### 7700 - 7900

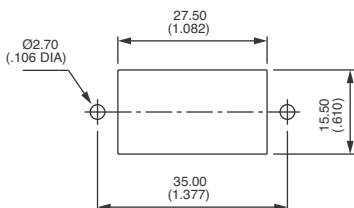



# 7000 series

## Rocker and paddle switches

Panel mounting : 7700N - 7900N

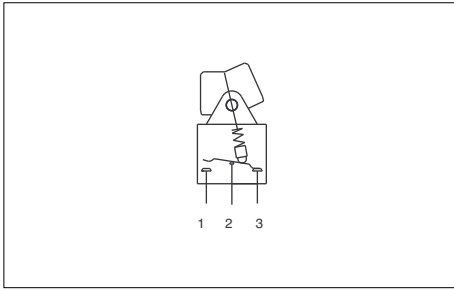

- Small or medium rocker or paddle
- Solder lug or straight PC terminals
- Quick-connect terminals : on request
- Epoxy sealing standard on models with straight PC terminals

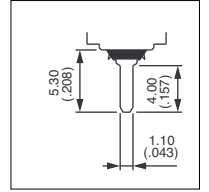
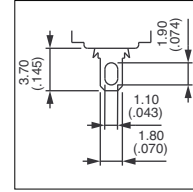

### MODEL STRUCTURE

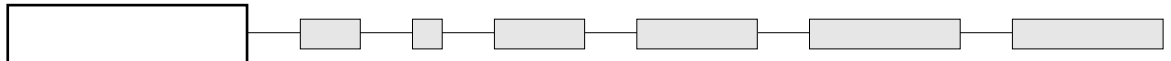

Shown with rocker U620

### Solder lug terminals : 7700N



Single pole	Double pole
7736N	7746N
7739N	7749N
7737N	7747N
7738N	7748N
7732N	7742N
	7744N*
	7744N 1R*
	7744N 2R*

III	II	I
2-3		1-2
5-6		4-5
ON	-	ON
ON	OFF	ON
MOM	OFF	MOM
ON	OFF	MOM
ON	-	MOM
ON	ON	ON
ON	ON	MOM
MOM	ON	MOM

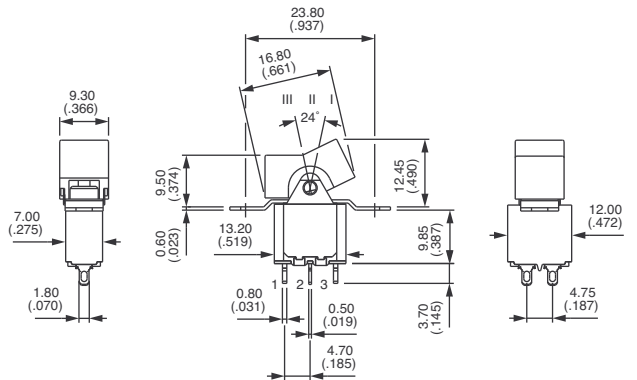

### Straight PC terminals : 7900N



Single pole	Double pole
7936N B	7946N B
7939N B	7949N B
7937N B	7947N B
7938N B	7948N B
7932N B	7942N B
	7944N B*
	7944N 1R B*
	7944N 2R B*

III	II	I
2-3		1-2
5-6		4-5
ON	-	ON
ON	OFF	ON
MOM	OFF	MOM
ON	OFF	MOM
ON	-	MOM
ON	ON	ON
ON	ON	MOM
MOM	ON	MOM

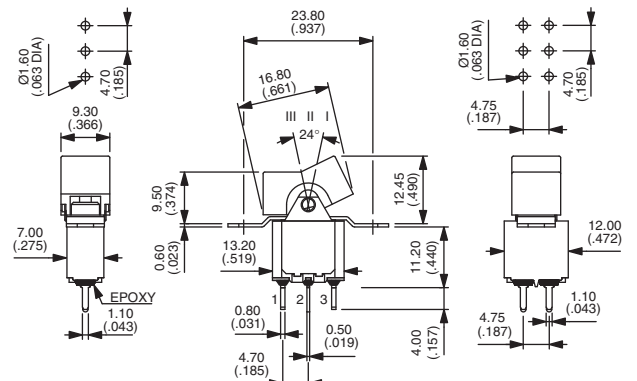

\* Function 4 : SP in DP case - specify CT or TH connections, see end of catalogue.

### PANEL CUT-OUT

#### 7700N - 7900N

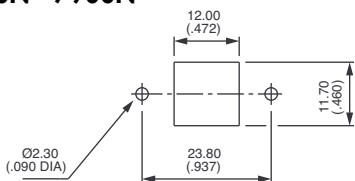

With small rocker **U730**  
or small paddle **U700**

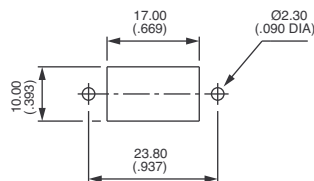

With medium rocker **U620**  
or medium paddle **U610**



# 7000 series

## Rocker and paddle switches

Right angle terminals - horizontal : 7900W

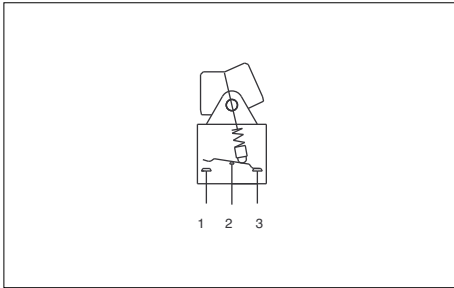

MODEL  
STRUCTURE

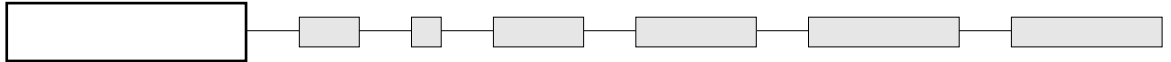

Shown with rocker U620

### Single pole



7936W  
7939W  
7937W  
7938W\*\*  
7932W\*\*

III	II	I
2-3		1-2
ON	-	ON
ON	OFF	ON
MOM	OFF	MOM
ON	OFF	MOM
ON	-	MOM

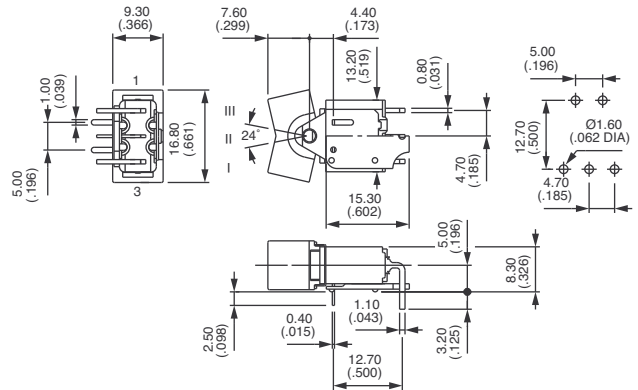

### Double pole



7946W  
7949W  
7947W  
7948W\*\*  
7942W\*\*  
7944W\*  
7944W 1R\*  
7944W 2R\*

III	II	I
2-3		1-2
5-6		4-5
ON	-	ON
ON	OFF	ON
MOM	OFF	MOM
ON	OFF	MOM
ON	-	MOM
ON	ON	ON
ON	ON	MOM
MOM	ON	MOM

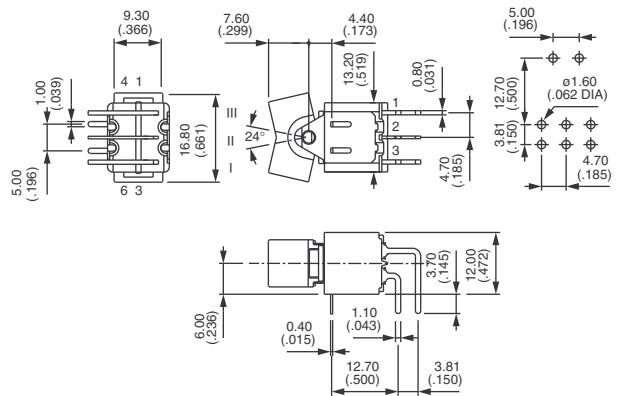

\* Function 4 : SP in DP case - specify CT or TH connections, see end of catalogue.

\*\* Functions 2 and 8 : standard connection (CT) shown on drawing - reversed connection available. Consult factory.

### PANEL CUT-OUT

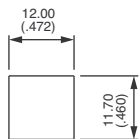

With small rocker **U730**  
or small paddle **U700**

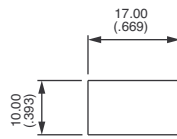

With medium rocker **U620**  
or medium paddle **U610**

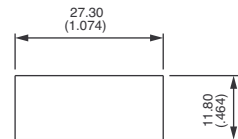

With large rocker **U1010**



# 7000 series

## Rocker and paddle switches

Right angle terminals - vertical : 7000WW

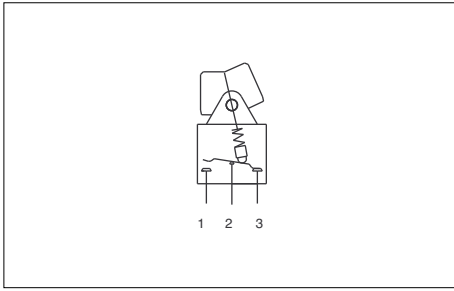

MODEL  
STRUCTURE

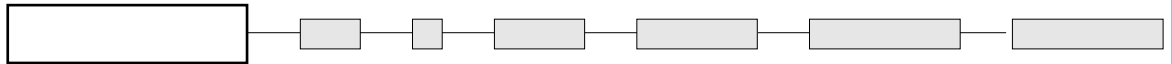

Shown with rocker U830

### Single pole



7036WW  
7039WW  
7037WW  
7038WW\*\*  
7032WW\*\*

III	II	I
2-3		1-2
ON	-	ON
ON	OFF	ON
MOM	OFF	MOM
ON	OFF	MOM
ON	-	MOM

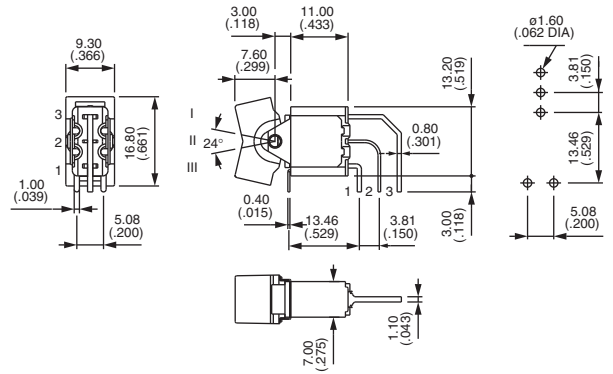

### Double pole



7046WW  
7049WW  
7047WW  
7048WW\*\*  
7042WW\*\*  
7044WW\*  
7044WW 1R\*  
7044WW 2R\*

III	II	I
2-3		1-2
5-6		4-5
ON	-	ON
ON	OFF	ON
MOM	OFF	MOM
ON	OFF	MOM
ON	-	MOM
ON	ON	ON
ON	ON	MOM
MOM	ON	MOM

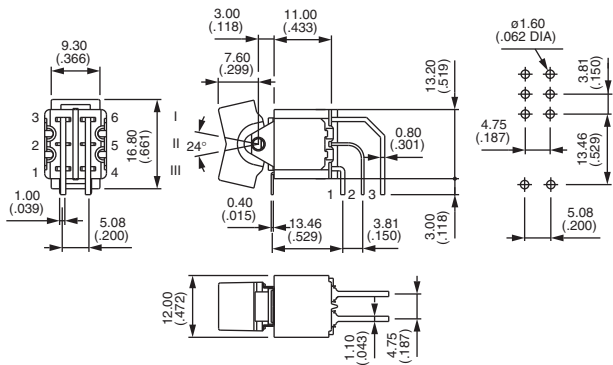

\* Function 4 : SP in DP case - specify CT or TH connections, see end of catalogue.

\*\* Functions 2 and 8 : standard connection (CT) shown on drawing - reversed connection available. Consult factory.

### PANEL CUT-OUT

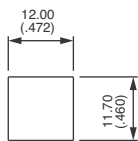

With small rocker **U730**

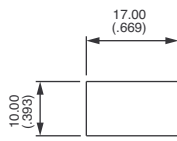

With medium rocker **U830**

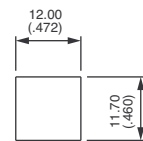

With broad paddle **U700**

# 7000 series

## Rocker and paddle switches

Straight PC terminals - bracket mounting : 7000Y

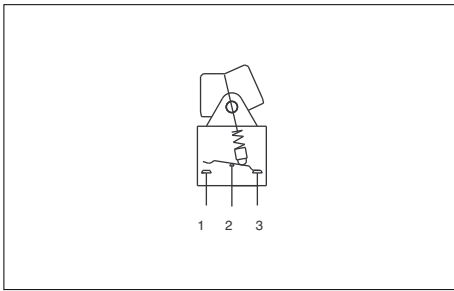

Brackets reduce mechanical stress on solder joints and increase the resistance to vibrations.

- Epoxy sealed terminals standard (B included in model structure)

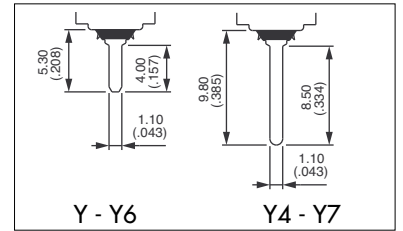

MODEL STRUCTURE

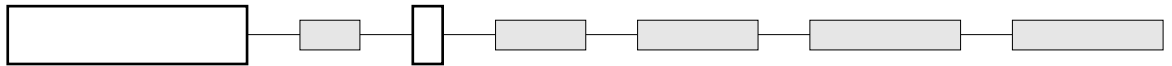

Shown with rocker U620

### Short bracket - width 15,75 (.620) - single pole : 7030Y



7036Y B  
7039Y B  
7037Y B  
7038Y B  
7032Y B

III	II	I
2-3		1-2
5-6		4-5
ON	-	ON
ON	OFF	ON
MOM	OFF	MOM
ON	OFF	MOM
ON	-	MOM

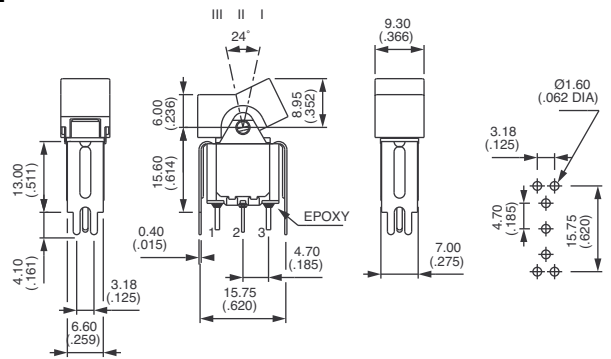

### Short bracket - width 15,75 (.620) - double pole : 7040Y



7046Y B  
7049Y B  
7047Y B  
7048Y B  
7042Y B  
7044Y\* B  
7044Y 1R\* B  
7044Y 2R\* B

III	II	I
2-3		1-2
5-6		4-5
ON	-	ON
ON	OFF	ON
MOM	OFF	MOM
ON	OFF	MOM
ON	-	MOM
ON	ON	ON
ON	ON	MOM
MOM	ON	MOM

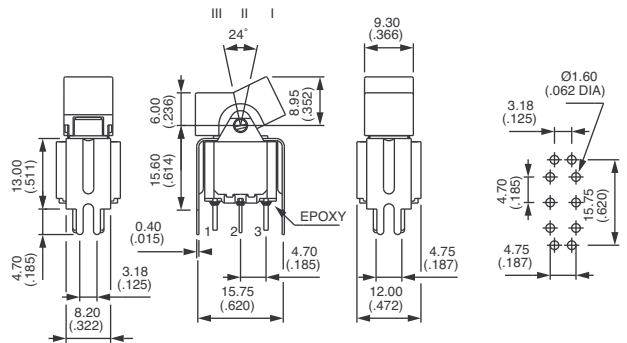

\* Function 4 : SP in DP case - specify CT or TH connections, see end of catalogue.



# 7000 series

## Rocker and paddle switches



### CONTACT MATERIALS

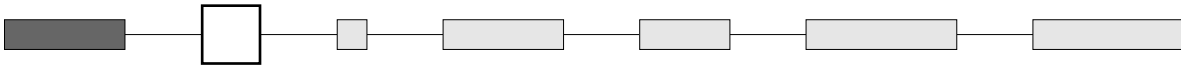

- A Silver
- AD Silver, gold plated
- CD Brass, gold plated

### SEALING

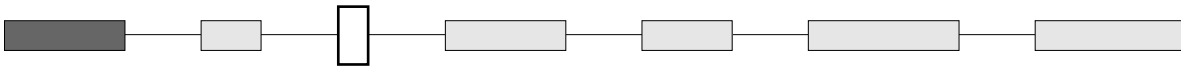

- Blank No sealing
- B Epoxy sealed terminals



### SPECIAL OPTIONS

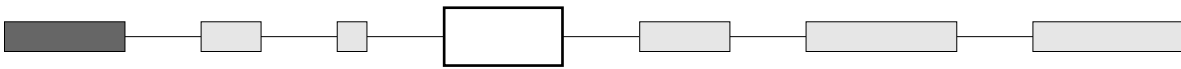

- Blank No special requirement
- X653 Vertical right angle with stand-off plate

Shown with rocker U620



	III	II	I
	2-3		1-2
	5-6		4-5
Single pole			
7036WW X653	7046WW X653	ON - ON	
7039WW X653	7049WW X653	ON OFF ON	
7037WW X653	7047WW X653	MOM OFF MOM	
7038WW X653	7048WW X653**	ON OFF MOM	
7032WW X653	7042WW X653**	ON - MOM	
	7044WW X653*	ON ON ON	
	7044 1RWW X653*	ON ON MOM	
	7044 2RWW X653*	MOM ON MOM	

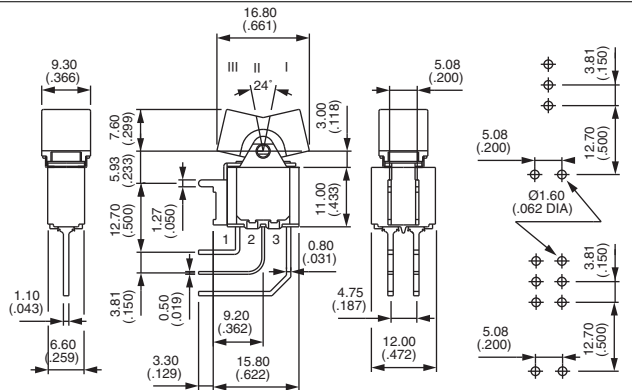

\* Function 4 : SP in DP case - specify CT or TH connections, see end of catalogue.

\*\* Functions 2 and 8 : reversed connection available. Consult factory.

Actuators for X653 : small rocker U730 and medium rocker U620, broad paddle U700 and narrow paddle U610.

- X601 Silver plated brass contacts  
Current voltage rating for an electrical life of 20.000 cycles : 0,5A 30VDC  
Minimum quantity : 5.000 pieces per model and shipment.



# 7000 series

## Rocker and paddle switches

### AGENCY APPROVALS

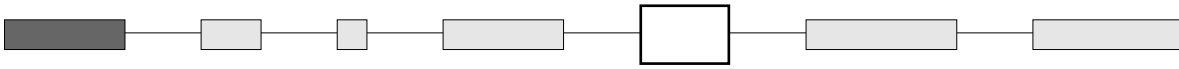

UL  
CSA

All standard models

**Availability :** consult factory for details of approved combinations or options.

**Marking :** to order switches marked UL or CSA, complete above box with desired approvals in this order, without space (ex. ULCSA). Blank : no agency approval required.

VDE (with UL & CSA)

Refer to **57000** series on the following pages.

### ACTUATORS

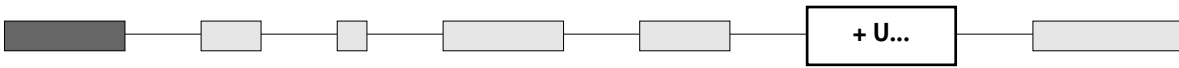

For snap-in mounting models : 7600 - 7200 - 7400 - 7200Z

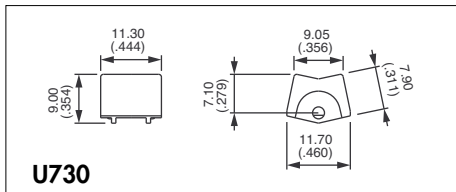

**U730**  
Small rocker

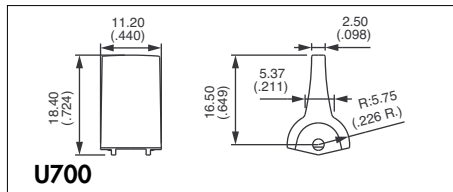

**U700**  
Broad paddle

Actuator colours	
Replace last "0" by number	
1	blue
1/4	dark blue
2	black
3	green
4	grey
5	yellow
6	red
7	ivory
7/1	white
9	orange

For 7700 and 7900 models

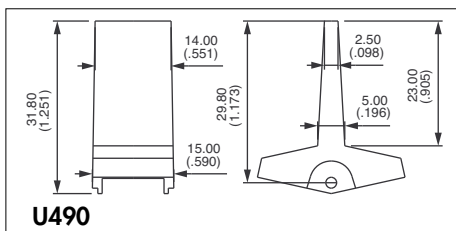

**U490**  
Large paddle

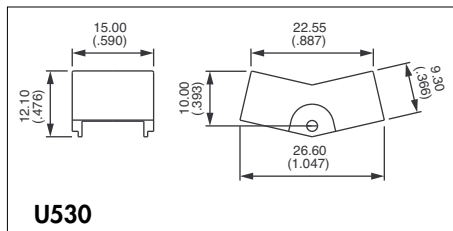

**U530**  
Large rocker

For 7700N - 7900N - 7900W - 7000WWX653 and 7000Y models

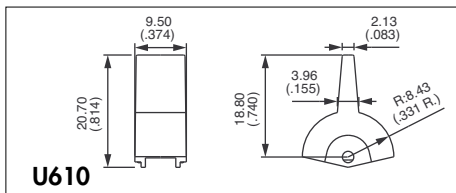

**U610**  
Narrow paddle

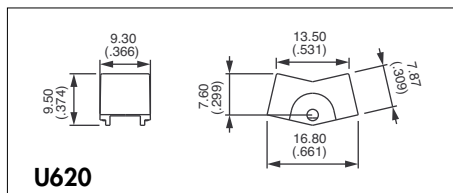

**U620**  
Medium rocker

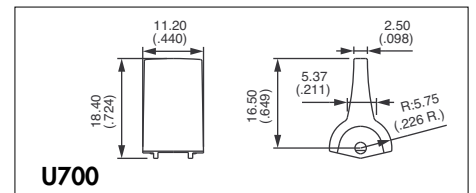

**U700**  
Broad paddle

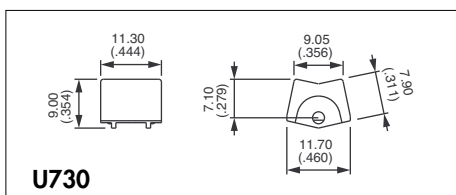

**U730**  
Small rocker

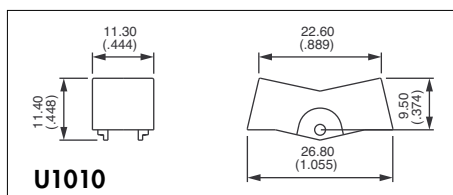

**U1010**  
Large rocker  
For 7900W, available on DP only.

# 7000 series

## Rocker and paddle switches

OPTIONS



### ACTUATORS (continued)

For 7000WW models

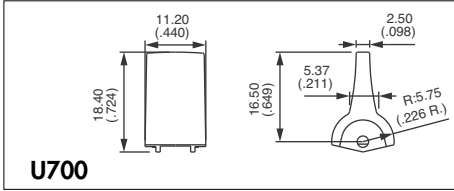

**U700**

Broad paddle

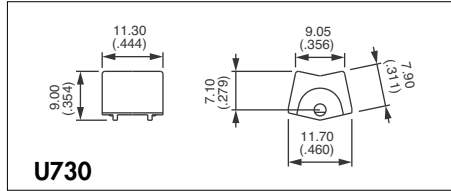

**U730**

Small rocker

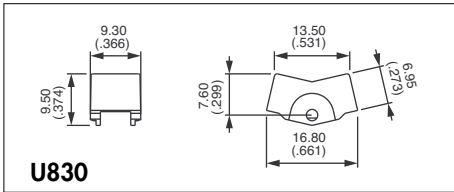

**U830**

Medium rocker

#### Actuator colours

Replace last "0" by number

- 1 blue
- 1/4 dark blue
- 2 black
- 3 green
- 4 grey
- 5 yellow
- 6 red
- 7 ivory
- 7/1 white
- 9 orange

### BEZELS - MOUNTING ACCESSORIES

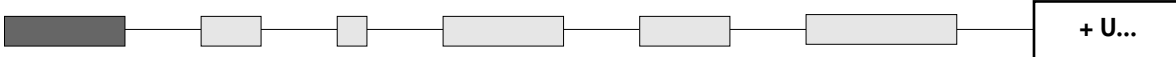

Bezels for paddle U700 and rocker U730

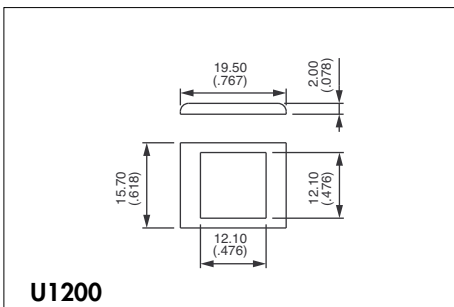

**U1200**

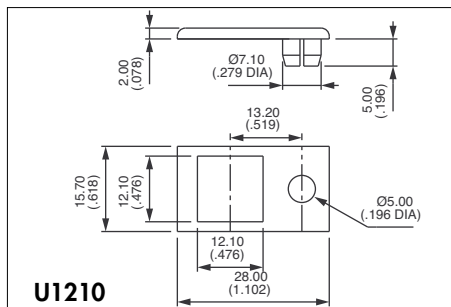

**U1210**

For LED Ø 5 (.196) - not supplied

#### Bezel colours

Replace last "0" by number

- 1 blue
- 1/4 dark blue
- 2 black
- 3 green
- 4 grey
- 5 yellow
- 6 red
- 7 ivory
- 7/1 white
- 9 orange

### STANDARD PANEL MOUNTING

Panel thickness with bezel 1 to 2,5 mm (.039 to .098)

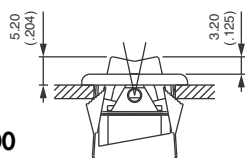

**U730 + U1200**

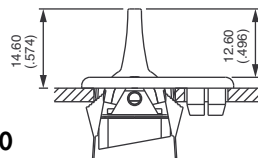

**U700 + U1210**

### Mounting accessories

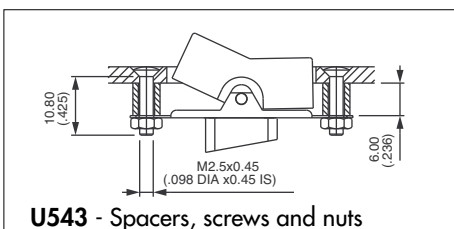

**U543 - Spacers, screws and nuts**

For rocker U530 or paddle U490

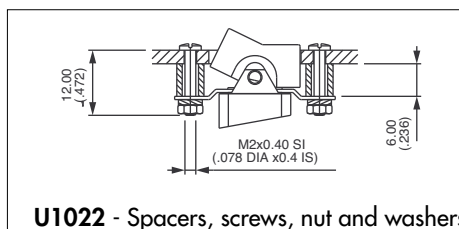

**U1022 - Spacers, screws, nut and washers**

For rockers U620 or U730  
For paddles U610 or U700



Компания «ЭлектроПласт» предлагает заключение долгосрочных отношений при поставках импортных электронных компонентов на взаимовыгодных условиях!

Наши преимущества:

- Оперативные поставки широкого спектра электронных компонентов отечественного и импортного производства напрямую от производителей и с крупнейших мировых складов;
- Поставка более 17-ти миллионов наименований электронных компонентов;
- Поставка сложных, дефицитных, либо снятых с производства позиций;
- Оперативные сроки поставки под заказ (от 5 рабочих дней);
- Экспресс доставка в любую точку России;
- Техническая поддержка проекта, помощь в подборе аналогов, поставка прототипов;
- Система менеджмента качества сертифицирована по Международному стандарту ISO 9001;
- Лицензия ФСБ на осуществление работ с использованием сведений, составляющих государственную тайну;
- Поставка специализированных компонентов (Xilinx, Altera, Analog Devices, Intersil, Interpoint, Microsemi, Aeroflex, Peregrine, Syfer, Eurofarad, Texas Instrument, Miteq, Cobham, E2V, MA-COM, Hittite, Mini-Circuits, General Dynamics и др.);

Помимо этого, одним из направлений компании «ЭлектроПласт» является направление «Источники питания». Мы предлагаем Вам помощь Конструкторского отдела:

- Подбор оптимального решения, техническое обоснование при выборе компонента;
- Подбор аналогов;
- Консультации по применению компонента;
- Поставка образцов и прототипов;
- Техническая поддержка проекта;
- Защита от снятия компонента с производства.



#### Как с нами связаться

**Телефон:** 8 (812) 309 58 32 (многоканальный)

**Факс:** 8 (812) 320-02-42

**Электронная почта:** [org@eplast1.ru](mailto:org@eplast1.ru)

**Адрес:** 198099, г. Санкт-Петербург, ул. Калинина, дом 2, корпус 4, литера А.