

6 mm carbon trimmer potentiometer PT6



Mechanical specifications

Mechanical rotation angle		$235^\circ \pm 5^\circ$
Electrical rotation angle		$200^\circ \pm 20^\circ$
Torque	Rotational	0.2 to 2 Ncm . (0.3 to 2.7 in - oz)
	Stop	> 4 Ncm. (>5.6 in-oz)
Life*		Up to 10K cycles

Electrical specifications

Range of values *		$220\Omega \leq R_n \leq 5M\Omega$ (Decad. 1.0 - 2.0 - 2.2 - 2.5 - 4.7 - 5.0)
Tolerance *	$220\Omega \leq R_n \leq 1M\Omega$	$\pm 20\%$
	$1M\Omega \leq R_n \leq 5M\Omega$	$\pm 30\%$
Max. voltage		100 VDC (lin) 50 VDC (no lin)
Nominal power 50°C (122°F) (see power rating curve)		0.1 W (lin) 0.05 W (no lin)
Taper *		Lin; Log; Alog (Log. & Alog. only $R_n > 1K$)
Residual resistance*		$\leq 0.5\% R_n$ (5Ω min.)
Equivalent noise resistance		$\leq 3\% R_n$ (3Ω min.)
Operating temperature **		-25°C to +70°C (-13°F to + 158°F)

* Others: check availability.

** Up to 85°C depending on application.

Main features

- Carbon resistive element.
- IP54 protection according to IEC 60529.
- Polyester substrate.
- SMD version available (see PS-6 datasheet).
- Wiper positioned at initial, 50% or fully clockwise.
- Also upon request:
 - Supplied in magazines for automatic insertion.
 - Long life model (10K cycles).
 - Housing available in self extinguishable plastic (UL94V0).
 - Mechanical detents.

Description

The PT-6 potentiometer offers control where frequent adjustment is required. The shaftless design allows for employment of different engagement mechanisms, such as a customized shaft, a motor control or a human interface adjustment.

This potentiometer can also control variable outputs including frequency, change in motor speed or volume.

Typical applications include test and measurement equipment, consumer electronics, appliances, timer relays, robotics, motion controllers, home and building automation and medical equipment control panels.

This datasheet shows you the basics of the PT-6 potentiometer that is quite versatile and easy to tailor. Do not hesitate to contact Piher for advice.

6 mm carbon trimmer potentiometer PT6

How to order

Optional extras

PT-6 K V - 221 A 2020 - - - - - - - - - -

Series	Mounting method	Taper	Life	Packaging	Knob/rotor colour	Wiper position
PT-6	K	V	221	A	2020	-
Rotors	H = Horizontal adjust V = Vertical adjust	A = Lin. B = Log. C = Alog.	- = 1K cycles E = 10 K cycles (See note 4)	- = Bulk T = Magazines (See note 5)	- = White AM = Yellow AZ = Blue CR = Cream GR = Grey IN = Not coloured NE = Black RO = Red VE = Green (See note 6)	- = Initial PM = 50% PF = Final
A K M Q W X (See note 1)						
Value	Tolerance	Detents	Shaft/Knob	Crimping		
221 = 220Ω 505 = 5M 000 = CM (See note 2)	3030 = ± 30% 2020 = ± 20% 1010 = ± 10% 0505 = ± 5% (See note 3)	- = None P04 P05 P06 P07 P08 P10	- = Fig. 1 02 = Fig. 2 03 = Fig. 3 04 = Fig. 4 05 = Fig. 5 (Use this option for rotors W or X only)	- = Crimped terminals SC = Not crimped		

NOTES:

- (1) Adjust. type: «X» is only available with horizontal adjusting method.
- (2) Value: - Code: $\frac{22}{1} = 220 \Omega$
 - 000 = CM = switch SPDT version (contact us for further information)



Resistance Ω	100	200	220	250	470	500	1K	2K	2.2K	2.5K	4.7K	5K	10K	20K	22K	25K	47K	50K	100K	200K	220K	250K	470K	500K	1M	2M	2.5M	4.7M	5M
How to order code	101	201	221	251	471	501	102	202	222	252	472	502	103	203	223	253	473	503	104	204	224	254	474	504	105	205	255	475	505
Standard tolerance	30%														20%										30%				

- (3) Tolerance (non standard, custom): check availability..... Code eg.: $\frac{+7}{-5} = \frac{07}{05}$
 - Negative tolerance
 - Positive tolerance

- (4) Life: • Standard = 1000 cycles • Long = 10K cycles (non-detented models)
- (5) Only for "V" mounting method. "W" rotor with shaft Fig. 2 is not available in magazines .
- (6) Potentiometer without knob or shaft, only the rotor. Potentiometer with knob or shaft, only the knob/shaft. The default colour for the knob and rotor is white.

Online product configurator: <https://piher.net/configurator/pt6-6-configurator-potentiometer/>

How to order examples

PT6KH-103A2020
 6mm potentiometer with rotor "K" (cross shape), H mounting method (horizontal adjustment), 10K resistive value, linear taper, 20% resistive tolerance and crimped terminals.

PT6WV-104A1010-5NE-SC
 6mm potentiometer with factory pre-inserted knob, V mounting method (vertical adjustment), 10K resistive value, linear taper, 10% resistive tolerance, black knob ref. 6148 and straight terminals (not crimped).

Standard default options

Mechanical life	-----	1000 cycles
Crimping	-----	Yes
Packing	-----	Bulk
Rotor colour	-----	White
Wiper send position	-----	Initial
Knob colour	-----	White
Detents	-----	None

6 mm carbon trimmer potentiometer PT6

Rotors



Mounting methods. Dimensions

V = horizontal mounting – vertical adjustment



H = vertical mounting – horizontal adjustment

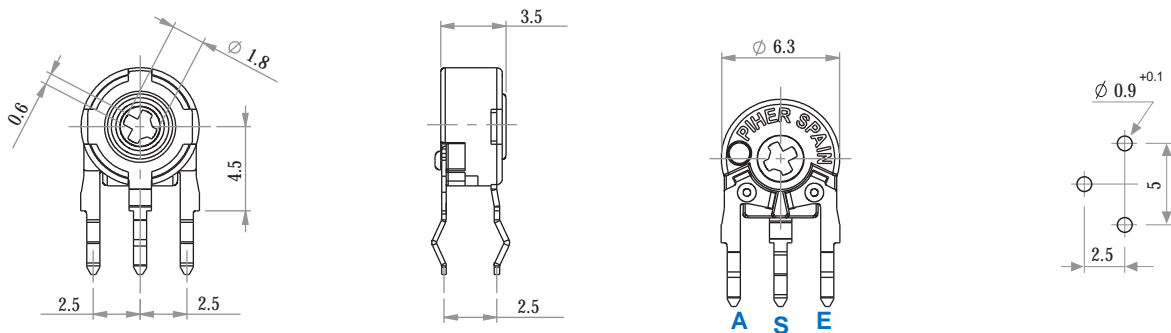

6 mm carbon trimmer potentiometer PT6

Crimped terminals (detail A)



This is the default terminals type.

Not-crimped terminals dimensions



Please indicate "SC" at the end of the part number for this version.



Download the STEP file here:
<https://piher.net/piher/?p=894>

SMD versions

SMD / SMT version available. See [PS-6](#) and [N-6](#) datasheets at: www.piher.net

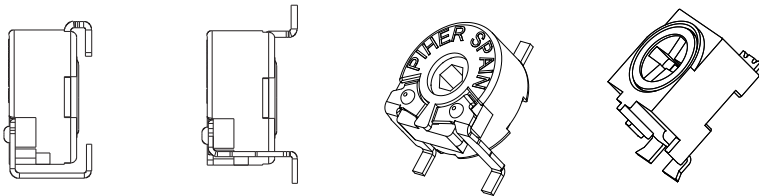

Standard Tapers

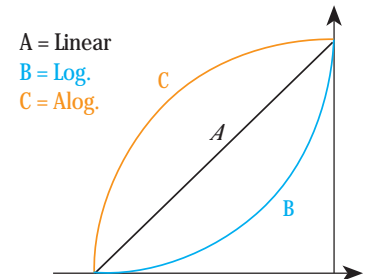

Detents / Stop positions

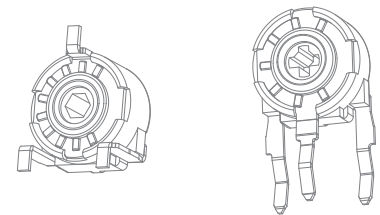

— Relative detent positions along the total mechanical travel.

NOTES FOR DETENTED VERSIONS

- All detented versions will be studied case by case. Contact Piher for leadtimes and availability.
- Others: check availability. Unless otherwise specified the detents are evenly spaced (using the end points as reference).
For more than 10 detents versions please contact Piher for more information.
- Standard mechanical life: 100 cycles.
- Long life versions are available under request. Contact Piher for more information.
- Detent torque can vary from 1.2 to 2.5 times the standard potentiometer torque.
- The colour of the rotor will be **violet**.

6 mm carbon trimmer potentiometer PT6

Knobs/Shfts

By default shafts, knobs & thumbwheels are delivered unassembled.

Mounted shafts, knobs & thumbwheels are delivered at random position. Custom positioning available.

If you wish to use your own plastic shaft/knob/actuator please contact Piher for advice about compatible materials.

Ref.: 5155 / Fig. 1

Default knob. Standard colour: white.



Ref.: 6132 / Fig. 2

Shaft. Not suitable for magazine packaging



Ref.: 5141 / Fig. 3

Colour: grey. For other colours check availability.



Ref.: 6172 / Fig. 4

Colour: grey. For other colours check availability.



Ref.: 6148 / Fig. 5



Ref.: 6160 / Fig. 6

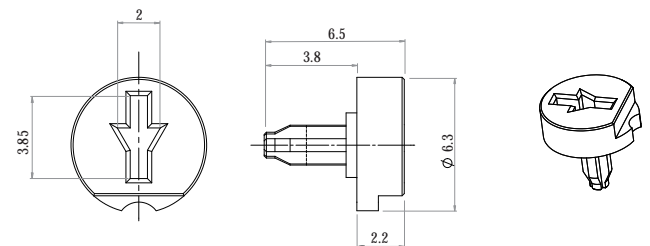

Positioning

Default position = CCW



Dual gang version . Ref 6060

6 mm carbon trimmer potentiometer PT6

Packaging

BOXES / BULK

Model	Units per box
All	1.000



AUTOMATIC INSERTION

Magazines	Units per magazine
PT-6 V & PT-6 WV	80 Pieces

Magazines for PT-6 V with or without crimping.



Tests

Test	Conditions	Typical variations
Electrical life	1.000 h. @ 50° C; 0.25 W	±5 %
Mechanical life (cycles)	1000 @ 10 CPM ...15 CPM	±3 % (Rn < 1 M)
Temperature coefficient	-25° C; +70° C	±300 ppm (Rn <100 K)
Thermal cycling	16 h. @ 85° C; 2h. @ -25° C	±2.5 %
Damp heat	500 h. @ 40° C @ 95% HR	±5 %
Vibration (for each plane,X,Y,Z)	2 h. @ 10 Hz. ... 55 Hz.	±2 %

Out of range values may not comply these results

Typical variations

Disclaimer

The product information in this catalogue is for reference purposes. Please contact Piher for the most up to date and accurate design information.

Piher Sensors & Controls S.A., its affiliates, agents, and employees, and all persons acting on its or their behalf (collectively, "Piher"), disclaim any and all liability for any errors, inaccuracies or incompleteness contained herein or in any other disclosure relating to any product described herein.

Piher disclaims any and all liability arising out of the use or application of any product described herein or of any information provided herein to the maximum extent permitted by law. The product specifications do not expand or otherwise modify Piher's terms and conditions of sale, including but not limited to the warranty expressed therein, which apply to these products.

No licence, express or implied, by estoppel or otherwise, to any intellectual property rights is granted by this document or by any conduct of Piher.

The products shown herein are not designed for use in medical, life-saving, or life-sustaining applications unless otherwise expressly indicated. Customers using or selling Piher products not expressly indicated for use in such applications do so entirely at their own risk and agree to fully indemnify Piher for any damages arising or resulting from such use or sale. Please contact authorised Piher personnel to obtain written terms and conditions regarding products designed for such applications.

Product names and markings noted herein may be trademarks of their respective owners.

Information contained in and/or attached to this catalogue may be subject to export control regulations of the European Community, USA, or other countries. Each recipient of this document is responsible to ensure that usage and/or transfer of any information contained in this document complies with all relevant export control regulations. If you are in any doubt about the export control restrictions that apply to this information, please contact the sender immediately. For any Piher Exports, Note: All products / technologies are EAR99 Classified commodities. Exports from the United States are in accordance with the Export Administration Regulations. Diversion contrary to US law is prohibited.

Piher is an Amphenol™ company.



All Piher products can be adapted to meet customer's requirements.

Please always use the latest updated datasheets and 3D models published at our website www.piher.net.

Recommended connections

Piher potentiometer's recommended connection circuit for a position sensor or control application. (voltage divider circuit electronic design)

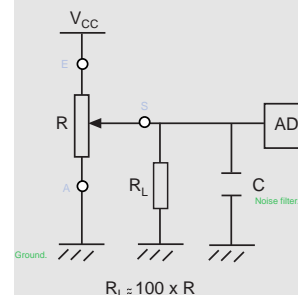

Power rating curve

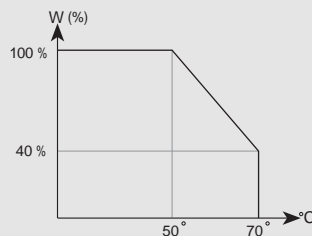

Contact

Piher Sensing Systems
Poligono Industrial Municipal
Vial T2 N°22
31500 Tudela - Spain
Tel: +34-948-820450

sales@piher.net

www.piher.net

rev100620





Компания «ЭлектроПласт» предлагает заключение долгосрочных отношений при поставках импортных электронных компонентов на взаимовыгодных условиях!

Наши преимущества:

- Оперативные поставки широкого спектра электронных компонентов отечественного и импортного производства напрямую от производителей и с крупнейших мировых складов;
- Поставка более 17-ти миллионов наименований электронных компонентов;
- Поставка сложных, дефицитных, либо снятых с производства позиций;
- Оперативные сроки поставки под заказ (от 5 рабочих дней);
- Экспресс доставка в любую точку России;
- Техническая поддержка проекта, помощь в подборе аналогов, поставка прототипов;
- Система менеджмента качества сертифицирована по Международному стандарту ISO 9001;
- Лицензия ФСБ на осуществление работ с использованием сведений, составляющих государственную тайну;
- Поставка специализированных компонентов (Xilinx, Altera, Analog Devices, Intersil, Interpoint, Microsemi, Aeroflex, Peregrine, Syfer, Eurofarad, Texas Instrument, Miteq, Cobham, E2V, MA-COM, Hittite, Mini-Circuits, General Dynamics и др.);

Помимо этого, одним из направлений компании «ЭлектроПласт» является направление «Источники питания». Мы предлагаем Вам помощь Конструкторского отдела:

- Подбор оптимального решения, техническое обоснование при выборе компонента;
- Подбор аналогов;
- Консультации по применению компонента;
- Поставка образцов и прототипов;
- Техническая поддержка проекта;
- Защита от снятия компонента с производства.



Как с нами связаться

Телефон: 8 (812) 309 58 32 (многоканальный)

Факс: 8 (812) 320-02-42

Электронная почта: org@eplast1.ru

Адрес: 198099, г. Санкт-Петербург, ул. Калинина, дом 2, корпус 4, литера А.