

# INTEGRATED PASSIVE COMPONENTS

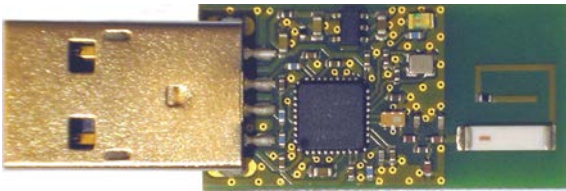
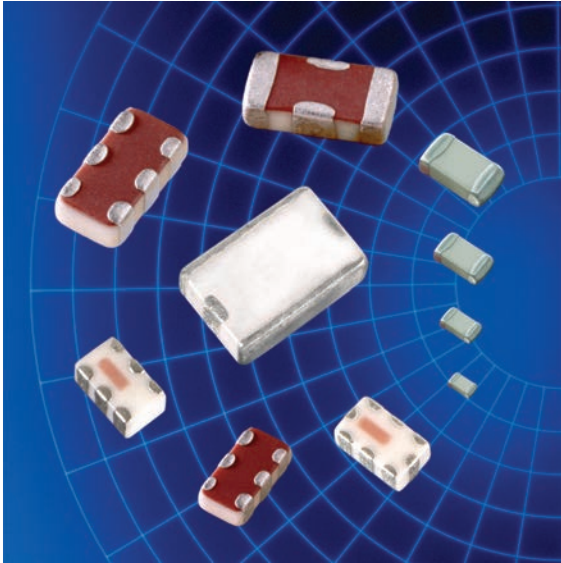

Johanson Technology has developed a line of small, highly reliable RF ceramic components manufactured with a proprietary LTCC (low temperature co-fired ceramic) process. These components operate over several bands from 900MHz to 6 GHz covering Cellular, DECT, WLAN, Bluetooth, 802.11 (a,b and g) and GPS applications.

In addition to the array of listed components we can support custom solutions for high volume applications with design flexibility and short development times. Contact us today with your specific technical requirements.

## KEY FEATURES

- Custom Solutions
- LTCC Based Designs
- Low Insertion Loss
- Miniature Size / Low Profile
- Temperature Stable
- Surface Mount
- RoHS Compliant, Standard, Use No Suffix
- Tin / Lead Term. Option, Add "/Pb" Suffix

## SUPPORTED APPLICATION BANDS

- Wireless LAN, Bluetooth, Home RF
- GSM/EDGE/GPRS/DCS/PCS/WCDMA
- WiMAX 802.16 d/e
- 2.4 GHz & 5.5 GHz ISM Band
- Zigbee
- MIMO
- GPS
- UNII
- UWB

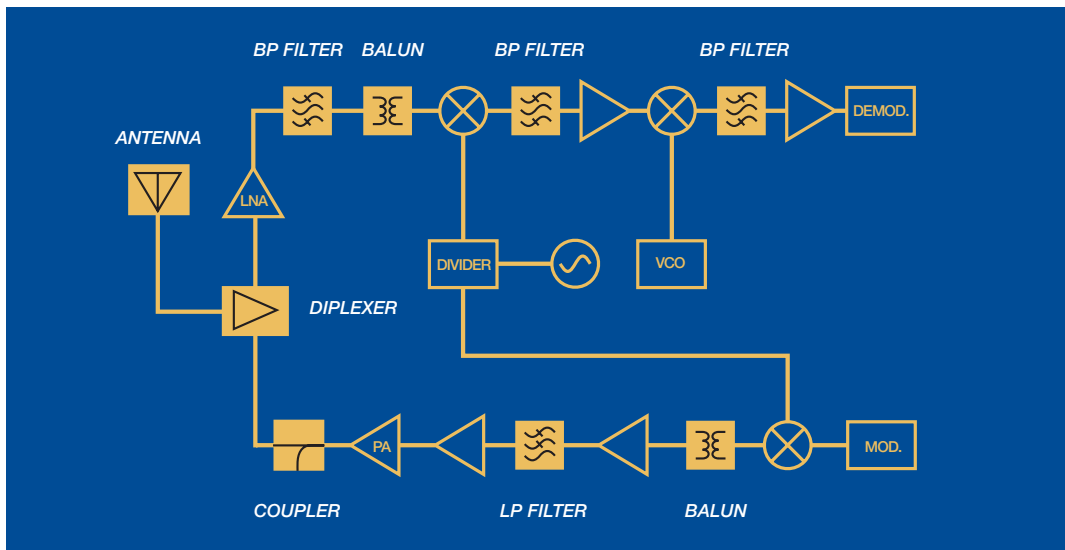

## CERAMIC CHIP ANTENNAS

| Part Number                       | Frequency (MHz)                           | Peak Gain                                 | Ave. Gain                                    | Return Loss (min)          | Case Size      |
|-----------------------------------|---|---|--|----------------------------|----------------|
| 0433AT62A0020                     | 423 - 443                                 | -4 dBi typ. (XZ-total)                    | -4 dBi typ. (XZ-total)                       | 9.5 dB                     | See Spec Sheet |
| 0783AT43A0008                     | 779 - 787                                 | -2.0 dBi typ. (XZ-total)                  | -5.0 dBi typ. (XZ-total)                     | 9.5 dB                     | 43-1           |
| 0868AT43A0020                     | 858 - 878                                 | -1.0 dBi typ (XZ-total)                   | -4.0 dBi typ (XZ-total)                      | 9.5 dB                     | 43-1           |
| 0920AT50A080                      | 880 - 960                                 | -0.7 dBi typ (XZ-V)                       | -2.6 dBi typ (XZ-V)                          | 8.5 dB                     | 50             |
| 0915AT43A0042                     | 894 - 936                                 | -1.0 dBi typ (XZ-total)                   | -4.0 dBi typ (XZ-total)                      | 8.5 dB                     | 43-1           |
| 0915AT43A0026                     | 902 - 928                                 | -1.0 dBi typ (XZ-total)                   | -4.0 dBi typ (XZ-total)                      | 8.5 dB                     | 43-1           |
| 0953AT43A0006                     | 950 - 956                                 | -1.0 dBi typ.(XZ-total)                   | -1.0 dBi typ.(XZ-total)                      | 9.5 dB                     | 43-1           |
| 1575AM55B0001                     | 1575.42 ± 5 MHz                           | 1.3 dBi typ (YZ-total)                    | -0.7 dBi typ (YZ-total)                      | 9.5 dB                     | See Spec Sheet |
| 1575AT43A0040                     | 1555 - 1595                               | - 1.5 dBi typ (XZ-V)                      | -2.5 dBi typ (XZ-V)                          | 9.5 dB                     | 43-1           |
| 1575AT47A0040_                    | 1555 - 1595                               | -1.0 dBi typ (XZ-V)                       | -3.0 dBi typ (XZ-V)                          | 9.5 dB                     | 47-1           |
| 1575AT54A0010                     | 1570 - 1580                               | 1.3 dBi typ (YZ-Total)                    | -0.7 dBi typ (YZ-Total)                      | 9.5 dB                     | See Spec Sheet |
| 1600AT45A0040                     | 1580 - 1620                               | 0.0 dBi typ (XZ-Total)                    | -1.0 dBi typ (XZ-Total)                      | 9.5 dB                     | 45-1           |
| 2000AT18A0075                     | 1965 - 2040                               | 0.3 dBi typ (XZ-V)                        | -3 dBi typ (XZ-V)                            | 9.5 dB                     | 18-4           |
| 2450AT18A100                      | 2400 - 2500                               | 0.5 dBi typ (XZ-V)                        | -0.5 dBi typ (XZ-V)                          | 9.5 dB                     | 18-4           |
| 2450AT18A0150                     | 2375 - 2525                               | 0.5 dBi typ (XZ-V)                        | -0.5 dBi typ (XZ-V)                          | 9.5 dB                     | 18-4           |
| 2450AT18B100                      | 2400 - 2500                               | 0.5 dBi typ (XZ-V)                        | -0.5 dBi typ (XZ-V)                          | 9.5 dB                     | 18-4           |
| 2450AT18D0100                     | 2400 - 2500                               | 1.5 dBi typ.(XZ-V)                        | -1.0 dBi typ.(XZ-V)                          | 6.0 dB                     | 18-5           |
| 2450AT42A100                      | 2400 - 2500                               | 0 dBi typ (XZ-V)                          | -1 dBi typ (XZ-V)                            | 9.5 dB                     | 42-1           |
| 2450AT42B100                      | 2400 - 2500                               | 0 dBi typ (XZ-V)                          | -1.5 dBi typ (XZ-V)                          | 9.5 dB                     | 42-1           |
| 2450AT42D0100                     | 2400 - 2500                               | 0.5 dBi typ (XZ-total)                    | -2.0 dBi typ (XZ-V)                          | 6.0 dB                     | 42-1           |
| 2450AT43A100                      | 2400 - 2500                               | 2.0 dBi typ (XZ-V)                        | 0.5 dBi typ (XZ-V)                           | 9.5 dB                     | 43-1           |
| 2450AT43B100                      | 2400 - 2500                               | 1.3 dBi typ (XZ-V)                        | -0.5 dBi typ (XZ-V)                          | 9.5 dB                     | 43-2           |
| 2450AT43D100                      | 2400 - 2500                               | -0.5 dBi typ                              | -3.6 dBi typ                                 | 9.5 dB                     | See Spec Sheet |
| 2450AT43F0100                     | 2400 - 2500                               | 2.1 dBi typ (XZ-total)                    | 1.0 dBi typ (XZ-total)                       | ---                        | See Spec Sheet |
| 2450AT43H0100                     | 2400 - 2500                               | 2.1 dBi typ. (XZ-V)                       | 1.0 dBi typ. (XZ-V)                          | 9.5 dB                     | See Spec Sheet |
| 2450AT45A100_                     | 2400 - 2500                               | 3.0 dBi typ (XZ-V)                        | 1.0 dBi typ (XZ-V)                           | 9.5 dB                     | 45-1           |
| 2450AD46A5388                     | LB: 2400 - 2500<br>HB: 4900 - 5875        | 1.0 dBi typ (XZ-V)<br>-1.5 dBi typ (YZ-V) | -2.5 dBi typ (XZ-V)<br>-2.5 dBi typ (YZ-V)   | 8.5 dB<br>8.5 dB           | See Spec Sheet |
| 2450AD46A5400<br>(Dual Band)      | LB: 2400 - 2500<br>HB: 4900 - 5900        | 1.0 dBi typ (XZ-V)<br>-1.5 dBi typ (XZ-V) | -2.5 dBi typ (YZ-V)<br>-2.5 dBi typ (YZ-V)   | 8.5 dB<br>8.5 dB           | 46-1           |
| 2500AT43A0100                     | 2450 - 2550                               | 0.6 dBi typ (YZ-total)                    | -2.1 dBi typ (XZ-total)                      | 3.0 dB                     | 43-1           |
| 2500AT44M0400                     | 2300 - 2700                               | 2.5 dBi typ                               | 0.5 dBi typ                                  | 9.5 dB                     | 44-2           |
| 2500AT52M3555<br>WiMax (Tri-Band) | 2300 - 2690<br>3300 - 3900<br>5150 - 5875 | 2.0 dBi typ<br>2.0 dBi typ<br>2.0 dBi typ | -2.0 dBi typ<br>-4.0 dBi typ<br>-3.0 dBi typ | 8.5 dB<br>9.5 dB<br>9.5 dB | See Spec Sheet |
| 2600AT44A0600                     | 2300 - 2900                               | 2.0 dBi                                   | 0.0 dBi typ.                                 | 9.5 dB                     | 42-2           |
| 2650AT43A0100                     | 2600 - 2700                               | 0.5 dBi typ (YZ-total)                    | -1.7 dBi typ (XZ-total)                      | 3.0 dB                     | 50             |
| 3100AT51A7200                     | 3100 - 10300                              | 1.5 dBi typ                               | -3.5 dBi typ                                 | 9.5 dB                     | 51-1           |
| 4000AT44A1800                     | 3100 - 4900                               | 2.7 dBi typ                               | -3.5 dBi typ                                 | 7.4 dB                     | See Spec Sheet |
| 5250AT43A200_                     | 5150 - 5350                               | 3.6 dBi typ (XZ-V)                        | -2.3 dBi typ (XZ-V)                          | 9.5 dB                     | 43-1           |
| 5400AT18A1000                     | 4900 - 5900                               | 2.0 dBi typ (XZ-V)                        | -2.5 dBi typ (XZ-V)                          | 8.5 dB                     | 18-4           |
| 5500AT18A0725                     | 5150 - 5875                               | 2.0 dBi typ. (XZ-V)                       | -2.5 dBi typ. (XZ-V)                         | 9.5 dB                     | 18-4           |
| 5775AT43A100_                     | 5725 - 5825                               | 3.9 dBi typ (XZ-V)                        | -1.5 dBi typ (XZ-V)                          | 9.5 dB                     | 43-1           |

Basic case size drawings for above part numbers are located on pages 39-40.

Detailed specifications and performance curves for the RF Ceramic Component line are located on our website.

## ANTENNA MODULES

| Part Number   | Center Freq. (MHz) | Peak Gain               | Ave. Gain                | Return Loss (min) | Case Size      |
|---------------|--------------------|-------------------------|--------------------------|-------------------|----------------|
| 1575AM55B0001 | 1575.42 ± 5 MHz    | 1.3 dBi typ. (YZ-total) | -0.7 dBi typ. (YZ-total) | 9.5 dB            | See Spec Sheet |

## BAND-PASS FILTERS: 2.45 GHZ

| Part Number   | Frequency (MHz) | Insertion Loss (max.)                    | Attenuation (min)   | Return Loss (min) | Case Size |
|---------------|-----------------|--|---|-------------------|-----------|
| 2450BP07A0100 | 2400 - 2500     | 2.5 dB                                   | 25 dB @ 824 - 960 MHz<br>25 dB @ 1710 - 1910 MHz<br>25 dB @ 4800 - 5000 MHz<br>15 dB @ 7200 - 7500 MHz                            | 9.5 dB            | 07-1      |
| 2450BP14D0100 | 2400 - 2500     | 1.7 dB                                   | 30 dB @ 880 - 915 MHz<br>30 dB @ 1710 - 1785 MHz<br>25 dB @ 1850 - 1910 MHz<br>25 dB @ 4800 - 5000 MHz<br>15 dB @ 7200 - 7500 MHz | 9.5 dB            | 14-1      |
| 2450BP14E0100 | 2400 - 2500     | 2.5 dB                                   | 35 dB @ 824 - 960 MHz<br>38 dB @ 1710 - 1910 MHz<br>25 dB @ 4800 - 5000 MHz<br>20 dB @ 7200 - 7500 MHz                            | 9.5 dB            | 14-1      |
| 2450BP15B100  | 2400 - 2500     | 2.2 dB                                   | 25 @ 1200 - 1300 MHz<br>10 @ 2000 MHz<br>12 @ 3000 MHz<br>30 @ 3600 - 3800 MHz<br>34 @ 4800 - 5000 MHz                            | 9.5 dB            | 15-3A     |
| 2450BP15C100  | 2400 - 2500     | 2.2 dB                                   | 30 dB @ 1200 - 1300 MHz<br>15 dB @ 2000 MHz<br>25 dB @ 3000 MHz<br>20 dB @ 3600 - 3800 MHz<br>20 dB @ 4800 - 5000 MHz             | 9.5 dB            | 15-3B     |
| 2450BP15D100  | 2400 - 2500     | 2.6 dB                                   | 30 dB @ 880 - 1990 MHz<br>20 dB @ 2110 - 2170 MHz<br>30 dB @ 4800 - 5000 MHz<br>20 dB @ 7200 - 7500 MHz                           | 9.5 dB            | 15-1F     |
| 2450BP15E0100 | 2400 - 2500     | 1.5 dB                                   | 30 dB @ 880 - 915 MHz<br>30 dB @ 1710 - 1785 MHz<br>25 dB @ 1850 - 1910 MHz<br>25 dB @ 4800 - 5000 MHz<br>15 dB @ 7200 - 7500 MHz | 9.5 dB            | 15-3C     |
| 2450BP15F0100 | 2400 - 2500     | 2.5 dB                                   | 35 dB @ 824 - 960 MHz<br>38 dB @ 1710 - 1910 MHz<br>25 dB @ 4800 - 5000 MHz<br>20 dB @ 7200 - 7500 MHz                            | 9.5 dB            | 15-1G     |
| 2450BP15G0100 | 2400 - 2500     | 2.0 dB                                   | 30 dB @ 824 - 960 MHz<br>28 dB @ 1710 - 1910 MHz<br>20 dB @ 1910 - 1990 MHz<br>30 dB @ 4800 - 5000 MHz<br>20 dB @ 7200 - 7500 MHz | 9.5 dB            | 15-1G     |
| 2450BP15H0100 | 2400 - 2500     | 1.5 max. @ 25°C<br>1.8 max. @ -40 - 85°C | 25 dB @ 1200 - 1300 MHz<br>10 dB @ 2000 MHz<br>12 dB @ 3000 MHz<br>30 dB @ 3600 - 3800 MHz<br>34 dB @ 4800 - 5000 MHz             | 9.5 dB            | 15-3C     |

Basic case size drawings for above part numbers are located on pages 39-40.

Detailed specifications and performance curves for the RF Ceramic Component line are located on our website.

## BAND-PASS FILTERS: 2.45 GHZ

| Part Number   | Frequency (MHz) | Insertion Loss (max.) | Attenuation (min)   | Return Loss (min) | Case Size |
|---------------|-----------------|-----------------------|---|-------------------|-----------|
| 2450BP18C100E | 2400 - 2500     | 2.5 dB                | 40 dB @ 1200 - 1800 MHz<br>25 dB @ 2100 MHz<br>35 dB @ 4800 - 5000 MHz<br>25 dB @ 7200 - 7500 MHz   | 9.5 dB            | 18-1      |
| 2450BP39C100A | 2400 - 2500     | 2.5 dB                | 42 dB @ 1710 - 1990 MHz<br>30 dB @ 2100 MHz<br>30 dB @ 4800 - 5000 MHz  | 9.5 dB            | 39-1B     |
| 2450BP39C100B | 2400 - 2500     | 1.8 dB                | 30 dB @ 1710 - 1780 MHz<br>25 dB @ 1850 - 1910 MHz<br>25 dB @ 4800 - 5000 MHz   | 9.5 dB            | 39-1B     |
| 2450BP39C100C | 2400 - 2500     | 1.5 dB                | 30 dB @ 800 - 915 MHz<br>30 dB @ 1710 - 1785 MHz<br>25 dB @ 1850 - 1910 MHz<br>25 dB @ 4800 - 5000 MHz<br>15 dB @ 7200 - 7500 MHz               | 9.5 dB            | 39-1B     |
| 2450BP39C100D | 2450 ± 50       | 2.2 dB                | 30 dB @ 880 - 915MHz<br>30 dB @ 1710 - 1785MHz<br>25 dB @ 1850 - 1910MHz<br>25 dB @ 2100MHz<br>25 dB @ 4800 - 5000MHz<br>15 dB @ 7200 - 7500MHz | 9.5 dB            | 39-1D     |
| 2450BP39D100B | 2400 - 2500     | 2.5 dB                | 35 dB @ 880 - 915 MHz<br>18 dB @ 1710 - 1990 MHz<br>12 dB @ 2100 MHz<br>35 dB @ 3200 MHz<br>22 dB @ 4800 - 5000 MHz<br>22 dB @ 7200 - 7500 MHz  | 9.5 dB            | 39-1B     |
| 2450BP39D100C | 2400 - 2500     | 1.2 dB                | 30 dB @ 880 - 915 MHz<br>30 dB @ 1710 - 1785 MHz<br>25 dB @ 1850 - 1910 MHz<br>25 dB @ 4800 - 5000 MHz<br>15 dB @ 7200 - 7500 MHz               | 9.5 dB            | 39-1B     |

Basic case size drawings for above part numbers are located on pages 39-40.

Detailed specifications and performance curves for the RF Ceramic Component line are located on our website.

## BAND-PASS FILTERS: 2.45 GHz

| Part Number   | Frequency (MHz) | Insertion Loss (max.) | Attenuation (min)  | Return Loss (min) | Case Size      |
|---------------|-----------------|-----------------------|--|-------------------|----------------|
| 2450BP39D100E | 2400 - 2500     | 1.2 dB                | 30 @ 880 - 915 MHz<br>30 @ 1710 - 1785 MHz<br>25 @ 1850 - 1910 MHz<br>2 @ 2700 MHz<br>25 @ 4800 - 5000 MHz<br>15 @ 7200 - 7500 MHz | 9.5 dB            | 39-1           |
| 2450BP39F100A | 2400 - 2500     | 2.4 dB                | 45 dB @ 880 - 915 MHz<br>48 dB @ 1710 - 1990 MHz<br>20 dB @ 2110 - 2170 MHz<br>30 dB @ 4800 - 5000 MHz<br>36 dB @ 7200 - 7500 MHz  | 9.5 dB            | 39-1B          |
| 2450BP41D100A | 2400 - 2500     | 2.3 dB                | 40 dB @ 1200 - 1800 GHz<br>30 dB @ 2100 GHz<br>12 dB @ 2200 GHz<br>35 dB @ 4800 - 5000 GHz   | 9.5 dB            | See Spec Sheet |
| 2450BP41D100B | 2400 - 2500     | 1.3 dB                | 30 dB @ 880 - 915 MHz<br>30 dB @ 1710 - 1785 MHz<br>20 dB @ 1850 - 1910 MHz<br>25 dB @ 4800 - 5000 MHz<br>20 dB @ 7200 - 7500 MHz  | 9.5 dB            | See Spec Sheet |
| 2450LP15B050  | 2400 - 2500     | 0.5 dB                | 32 dB @ 2 x fo<br>30 dB @ 3 x fo<br>30 dB @ 4 x fo   | 10.9 dB           | See Spec Sheet |
| 2500BP15M400  | 2300 - 2700     | 2.0 dB                | 15 dB @ 100 - 1800 MHz<br>20 dB @ 3400 - 11700 MHz   | 9.5 dB            | 39-1           |

## BAND-PASS FILTERS: 5.5 GHz

| Part Number   | Frequency (MHz) | Insertion Loss (max.) | Attenuation (min)   | Return Loss (min) | Case Size      |
|---------------|-----------------|-----------------------|---|-------------------|----------------|
| 5400BP39A0100 | 4900 - 5900     | 3.5 dB                | 24 dB @ 3800 - 4500 MHz<br>20 dB @ 6300 - 7100 MHz                      | 8.5 dB            | See Spec Sheet |
| 5515BP15B975  | 4900 - 5875     | 1.5 dB                | 30 dB @ 3500 MHz  | 9.5 dB            | 15-3B          |
| 5515BP15C725  | 5150 - 5875     | 2.0 dB                | 30 dB @ 500 - 4000 MHz<br>20 dB @ 4600 MHz<br>15 dB @ 10300 - 11800 MHz | 9.5 dB            | 15-3           |
| 5515BP15C975  | 4900 - 5875     | 1.8 dB                | 30 dB @ 500 - 4000MHz<br>20 dB @ 4200MHz<br>15 dB @ 9800 - 11750MHz     | 8.5 dB            | 15-3B          |
| 5515BP15C1020 | 4900 - 5920     | 1.5 dB                | 30 dB @ 3500 MHz  | 9.5 dB            | 15-3B          |

Basic case size drawings for above part numbers are located on pages 39-40.

Detailed specifications and performance curves for the RF Ceramic Component line are located on our website.

## BAND-PASS FILTERS: OTHER

| Part Number   | Frequency (MHz) | Insertion Loss (max)                         | Attenuation (min)  | Return Loss (min) | Case Size      |
|---------------|-----------------|--|--|-------------------|----------------|
| 1200BP44A575  | 950 - 1525      | 2.8 dB                                       | 25 dB @ 100 - 480 MHz<br>25 dB @ 1900 - 3050 MHz   | 7.0 dB            | 44-1           |
| 1810BP07B200  | 1700 - 1900     | 1.8 dB                                       | 20 dB @ 855-955 (Prelim.)<br>10 dB @ 2565-2865 (Prelim.)   | TBD               | 07-1           |
| 1906BP18A027  | 1893 - 1920     | 1.5 dB                                       | 38 dB @ 1405 - 1440 MHz<br>10 dB @ 1649 - 1680 MHz<br>24 dB @ 3786 - 3840 MHz<br>20 dB @ 5679 - 5760 MHz   | 9.5 dB            | 18-1           |
| 1906BP18C027  | 1893 - 1920     | 3.0 dB                                       | 40 dB @ 1427 - 1454 MHz<br>35 dB @ 1660 - 1687 MHz<br>15 dB @ 2126 - 2153 MHz  | 9.5 dB            | See Spec Sheet |
| 1906BP39B027  | 1893 - 1920     | 2.8 dB                                       | 40 dB @ 1660 MHz<br>12 dB @ 2139 MHz   | 9.5 dB            | See Spec Sheet |
| 2593BP44B186  | 2500 - 2686     | 2.0 dB                                       | 40 dB @ 1870 - 2056 MHz  | 9.5 dB            | 44-1           |
| 2598BP39A0205 | 2495 - 2700     | 3.0 dB                                       | 12 dB @ 2039 - 2244 MHz<br>24 dB @ 2951 - 3156 MHz<br>12 dB @ 4990 - 5400 MHz  | 9.5 dB            | See Spec Sheet |
| 2600BP14M0200 | 2500 - 2700     | 2.2 dB max @ 25°C<br>2.5 dB max @ -40 - 85°C | 30 dB @ 806 - 915MHz<br>30 dB @ 1710 - 1785MHz<br>30 dB @ 1850 - 1910MHz<br>30 dB @ 1920 - 1980MHz<br>13 dB @ 3300 - 3900MHz<br>20 dB @ 4900 - 5900MHz | 9.5 dB            | See Spec Sheet |
| 3480BP39A0140 | 3410 - 3550     | 4.0 dB                                       | 30 dB @ < 2540 MHz<br>14 dB @ 4020 MHz<br>34 dB @ 5150 - 5350 MHz  | 10 dB             | See Spec Sheet |
| 3600BP14M0600 | 3300 - 3700     | 1.8 dB max @ 25°C<br>2.0 dB max @ -40 - 85°C | 30 dB @ 806 - 915MHz<br>30 dB @ 1710 - 1785MHz<br>30 dB @ 1850 - 1910MHz<br>30 dB @ 1920 - 1980MHz<br>31 dB @ 2400 - 2500MHz<br>18 dB @ 4900 - 5900MHz | 12 dB             | See Spec Sheet |
| 3600BP15M600  | 3300 - 3900     | 1.8 dB                                       | 15 dB @ 100 - 2600 MHz<br>9 dB @ 4400 MHz<br>20 dB @ 6000 - 9900 MHz   | 9.5 dB            | 15-3B          |
| 3960BP39A1584 | 3168 - 4752     | 2.5 dB                                       | 30 dB @ 2400 - 2500 MHz<br>12 dB @ 5150 MHz<br>25 dB @ 5950 MHz  | 9.5 dB            | See Spec Sheet |
| 4000BP15U1800 | 3100 - 4900     | 2.0 dB                                       | 25 dB @ 1.75 GHz<br>13 dB @ 2.10 GHz   | 8.5 dB            | 15-2B          |
| 4000NF39A6550 | 3200 - 4800     | 3.0 dB                                       | 14 dB @ 5150 - 5350 MHz  | 7.0 dB            | See Spec Sheet |
| 4020BP39A0160 | 3940 - 4100     | 4.0 dB                                       | 34 dB @ < 2540 MHz<br>14 dB @ 3480 MHz<br>14 dB @ 4560 MHz<br>34 dB @ 5150 - 5350 MHz  | 20.8 dB           | See Spec Sheet |
| 4560BP39A0180 | 4470 - 4650     | 2.97 dB                                      | 48.3 dB @ < 2540 MHz<br>19.1 dB @ 4020 MHz<br>19 dB @ 5150 - 5350 MHz<br>35.9 dB @ 5725 - 7000 MHz   | 17.5 dB           | See Spec Sheet |

Basic case size drawings for above part numbers are located on pages 39-40.

Detailed specifications and performance curves for the RF Ceramic Component line are located on our website.



## HIGH-PASS FILTERS

| Part Number   | Frequency (MHz) | Insertion Loss (max)                         | Attenuation (min)   | Return Loss (min) | Case Size      |
|---------------|-----------------|--|---|-------------------|----------------|
| 1900HP41B500  | 1650 - 2150     | 2.0 dB (Prelim)                              | 27 dB @ 950 - 1450 MHz (Prelim)   | 8.5 dB            | 41-1           |
| 1900HP41C0500 | 1650 - 2150     | 2.0 dB                                       | 27 dB @ 950 - 1450 MHz  | 8.5 dB            | 41-1           |
| 2450HP14A100  | 2400 - 2500     | 1.0 dB                                       | 9 dB @ 824 - 960 MHz<br>20 dB @ 1917 MHz                                    | 9.5 dB            | 14-1B          |
| 2450HP15A100  | 2400 - 2500     | 0.85 dB                                      | 25 dB @ 875 - 920 MHz<br>20 dB @ 1705 - 1790 MHz<br>19 dB @ 1845 - 1915 MHz | 9.5 dB            | See Spec Sheet |
| 3550HP15A0500 | 3300 - 3800     | 0.6 dB max. @ 25°C<br>0.8 dB max. @ -40-85°C | 40 dB @ 1710-1910 MHz   | 9.5 dB            | See Spec Sheet |
| 5200HP15A4200 | 3100 - 7300     | 2.5 dB                                       | 30 dB @ < 2540 MHz<br>12 dB @ 2800 MHz                                      | 9.5 dB            | See Spec Sheet |

## NOTCH FILTER

| Part Number   | Frequency Range (max)  | Insertion Loss (max) | Attenuation (min)      | Return Loss (min) | Case Size |
|---------------|------------------------|----------------------|------------------------|-------------------|-----------|
| 4000NF39A6550 | 3.0 dB @ 3200-4800 MHz | 3.0 @ 5900-7200 MHz  | 30 dB @ 950 - 1450 MHz | 8.5 dB            | 41-1      |

## EMI FILTER

| Part Number   | No. of Sections | Cutoff Freq (MHz) | Attenuation (min)      | Case Size      |
|---------------|-----------------|-------------------|------------------------|----------------|
| 0400FA15A0400 | 4               | 400               | 20 dB @ 800 - 1000 MHz | See Spec Sheet |

## JOHANSON-TEXAS INSTRUMENTS REFERENCE DESIGN - CC2530

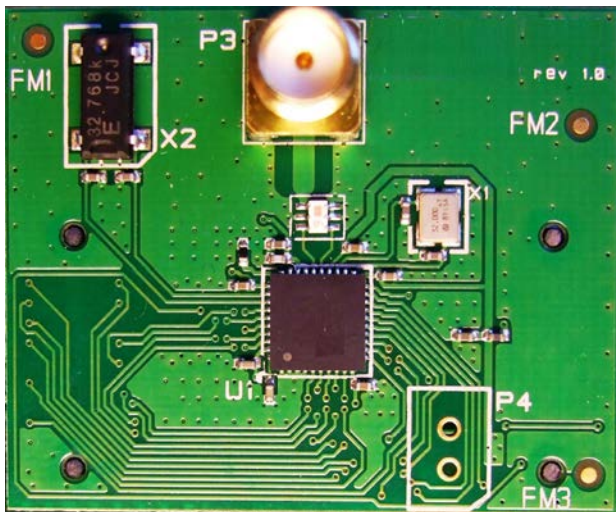

T.I. CC2530 Reference Design using Johanson

Complete passive component integration for RF Chipsets layout and design.

Johanson matched-impedance balun-filter integrated passive with TI CC2530 RF chipset.

Note: Only one component between chip and antenna SMA

Johanson p/n: 2450BM15A0002

Basic case size drawings for above part numbers are located on pages 39-40.

Detailed specifications and performance curves for the RF Ceramic Component line are located on our website.

## LOW-PASS FILTERS

| Part Number   | Frequency (MHz)          | Insertion Loss (max)                         | Attenuation (min)  | Return Loss (min) | Case Size      |
|---------------|--------------------------|--|--|-------------------|----------------|
| 0500LP15A500  | 0 - 500                  | 0.7 dB                                       | 9 dB @ 824 - 960 MHz<br>25 dB @ 1710 - 1990 MHz<br>25 dB @ 2400 - 4000 MHz       | 9.5 dB            | See Spec Sheet |
| 0868LP15A020  | 858 - 878                | 0.5 dB                                       | 30 dB @ 2 x Fo<br>40 dB @ 3 x Fo   | 14.0 dB           | 15-1           |
| 0869LD14C1810 | 824 - 915<br>1710 - 1910 | 0.6 dB<br>0.6 dB                             | 25 dB @ 2 x Fo - 18 dB @ 3 x Fo<br>22 dB @ 2 x Fo - 20 dB @ 3 x Fo               | 9.5 dB            | 14-1           |
| 0869LD14D1810 | 824 - 915<br>1710 - 1910 | 0.6 dB<br>0.6 dB                             | 25 dB @ 1648-1830 - 25 dB @ 3420-3820<br>25 dB @ 2472 - 2745 - 25 dB @ 5130-5730 | 14 dB             | 14-1           |
| 0869LP14A090  | 824 - 915                | 0.6 dB                                       | 20 dB @ 2x Fo<br>15 dB @ 3x Fo   | 10.9 dB           | 14-1A          |
| 0892LP07A136  | 824 - 960                | 0.7 dB                                       | 18 dB @ 1648 - 1920 MHz<br>25 dB @ 2472 - 2880 MHz<br>25 dB @ 3296 - 3840 MHz    | 9.5 dB            | See Spec Sheet |
| 0898LP18A035  | 880 - 915                | 0.6 dB                                       | 30 dB @ 2x Fo<br>18 dB @ 3x Fo   | 10.9 dB           | 18-2           |
| 0915LP15A026  | 902 - 928                | 0.65 dB                                      | 25 dB @ 2x Fo<br>25 dB @ 3x Fo   | 9.5 dB            | 15-2           |
| 0915LP15B026  | 902 - 928                | 0.5 dB                                       | 30 dB @ 2x Fo<br>30 dB @ 3x Fo   | 14.0 dB           | 15-2A          |
| 1175LP15A0550 | 900 - 1450               | 2.5 dB                                       | 25 dB @ 1650 - 2200 MHz  | 9.5 dB            | 15-2           |
| 1200LP41B0500 | 950 - 1450               | 2.0 dB                                       | 24 dB @ 1650-2150 (+25°C)  | 8.5 dB            | See Spec Sheet |
| 1200LP41C0500 | 950 - 1450               | 2.0 dB                                       | 24 dB @ 1650-2150 (+25°C)  | 8.5 dB            | See Spec Sheet |
| 1748LP18A075  | 1710 - 1785              | 0.6 dB                                       | 30 dB @ 3500 MHz<br>20 dB @ 5240 MHz   | 10.9 dB           | 18-2           |
| 1810LP07A200  | 1710 - 1910              | 0.5 dB                                       | 20 dB @ 2x Fo<br>20 dB @ 3x Fo   | 10.9 dB           | 07-1           |
| 1810LP07B200  | 1710 - 1910              | 0.6 dB                                       | 26 dB @ 3420 - 3570 MHz<br>21 dB @ 3700 - 3820 MHz<br>21 dB @ 5130 - 5730 MHz    | 9.5 dB            | 07-1           |
| 1810LP14A200  | 1710 - 1910              | 0.6 dB                                       | 30 dB @ 3420 - 3570 MHz<br>25 dB @ 3700 - 3820 MHz<br>20 dB @ 5130 - 5730 MHz    | 11.7 dB           | 14-1A          |
| 1880LP14A060  | 1850 - 1910              | 0.6 dB                                       | 27 dB @ 2x Fo<br>19 dB @ 3x Fo   | 11.7 dB           | 14-1A          |
| 2400LP18A0200 | 2300 - 2500              | 0.6 dB                                       | 27 dB @ 2 x Fo<br>18 dB @ 3 x Fo   | 10.9 dB           | See Spec Sheet |
| 2450LP07A0100 | 2400 - 2500              | 0.45 dB max @ 25°C<br>0.55 dB max @ -40-85°C | 21 dB @ 4800 - 5000 MHz<br>21 dB @ 7200 - 7500 MHz                               | 11.7 dB           | 07-1           |
| 2450LP14A100  | 2400 - 2500              | 0.5 dB                                       | 25 dB @ 2x Fo<br>18 dB @ 3x Fo   | 14.0 dB           | 14-1A          |
| 2450LP14B100  | 2400 - 2500              | 0.5 dB                                       | 35 dB @ 2x Fo<br>25 dB @ 3x Fo   | 14.0 dB           | 14-1A          |

Basic case size drawings for above part numbers are located on pages 39-40.

Detailed specifications and performance curves for the RF Ceramic Component line are located on our website.



## LOW-PASS FILTERS

| Part Number   | Frequency (MHz) | Insertion Loss (max) | Attenuation (min)   | Return Loss (min) | Case Size |
|---------------|-----------------|----------------------|---|-------------------|-----------|
| 2450LP15A050  | 2400 - 2500     | 0.5 dB               | 27 dB @ 2x $F_o$<br>25 dB @ 3x $F_o$                        | 10.9 dB           | 15-2      |
| 2450LP15B050  | 2400 - 2500     | 0.5 dB               | 32 dB @ 2 x $F_o$<br>30 dB @ 3 x $F_o$<br>30 dB @ 4 x $F_o$ | 10.9 dB           | 15-2      |
| 2500LP14A0400 | 2300 - 2700     | 0.55 dB              | 35 dB @ 2 x $F_o$<br>25 dB @ 3 x $F_o$                      | 11.7 dB           | 14-1      |
| 2500LP14B0400 | 2300 - 2700     | 0.62 dB              | 27 dB @ 2 x $F_o$<br>25 dB @ 3 x $F_o$                      | 14.0 dB           | 14-1      |
| 3550LP14A300  | 3400 - 3700     | 0.65 dB              | 25 dB @ 3x $F_o$  | 14.0 dB           | 14-1      |
| 5515LP15A730  | 5150 - 5875     | 0.5 dB               | 25 dB @ 2x $F_o$<br>18 dB @ 3x $F_o$                        | 10.9 dB           | 15-2      |

## DUAL LOW PASS FILTER

| Part Number   | Frequency (MHz)          | Insertion Loss (max) | Attenuation (min) |                | Return Loss (min) | Case Size |
|---------------|--------------------------|----------------------|-------------------|----------------|-------------------|-----------|
|               |                          |                      | 2x $F_o$          | 3x $F_o$       |                   |           |
| 0869LD14C1810 | 824 - 915<br>1710 - 1910 | 0.6 dB<br>0.6 dB     | 25 dB<br>22 dB    | 18 dB<br>20 dB | 9.5 dB            | 14-1      |

## DIRECTIONAL COUPLERS

| Part Number   | Frequency (MHz) | Insertion Loss (max) | Return Loss (min) | Coupling (dB)  | Isolation (min.) | Case Size |
|---------------|-----------------|----------------------|-------------------|----------------|------------------|-----------|
| 0450CP14A0040 | 430 - 470       | 0.2 dB               | 20.8 dB           | 27.5 ± 2.0 dB  | 45.0 dB          | 14-1      |
| 0848CP14A075  | 810 - 885       | 0.25 dB              | 15.6 dB           | 20.3 ± 1.0 dB  | 28.0 dB          | 14-1      |
| 0869CP14A090  | 824 - 915       | 0.3 dB               | 15.6 dB           | 17 ± 1.0 dB    | 26.0 dB          | 14-1      |
| 0898CP14A035  | 880 - 915       | 0.28 dB              | 15.6 dB           | 18 ± 1.0 dB    | 26.0 dB          | 14-1      |
| 0898CP14B035  | 880 - 915       | 0.25 dB              | 15.6 dB           | 20 ± 1.0 dB    | 28.0 dB          | 14-1      |
| 0898CP15A035  | 880 - 915       | 0.50 dB              | 14.0 dB           | 20 ± 1.0 dB    | 25.0 dB          | 15-1      |
| 0967CP14A024  | 955 - 979       | 0.50 dB              | 15.6 dB           | 12.5 ± 1.0 dB  | 19.0 dB          | 14-1      |
| 1575CH15A0030 | 1560 - 1590     | 3.3 ± 0.5 dB max.    | 10.0 dB           |                | 16.0 dB          | 15-1      |
| 1747CP14A075  | 1710 - 1785     | 0.44 dB              | 15.6 dB           | 14.5 ± 1.0 dB  | 25.0 dB          | 14-1      |
| 1748CP15A075  | 1710 - 1785     | 0.50 dB              | 14.0 dB           | 20 ± 1.0 dB    | 25.0 dB          | 15-1      |
| 1810CP14A200  | 1710 - 1910     | 0.30 dB              | 15.6 dB           | 20 ± 1.0 dB    | 25.0 dB          | 14-1      |
| 2450CP14A100  | 2400 - 2500     | 0.74 dB              | TBD dB            | 10 ± 1.0 dB    | 22.0 dB          | 14-1      |
| 2450CP14B100  | 2400 - 2500     | 0.34 dB              | TBD dB            | 17.65 ± 1.0 dB | 25.0 dB          | 14-1      |
| 2600CF15A0200 | 2500 - 2700     | 1.0 dB               | 16.0 dB           | 20 ± 1.0 dB    | 29.0 dB          | 15-1      |

Basic case size drawings for above part numbers are located on pages 39-40.

Detailed specifications and performance curves for the RF Ceramic Component line are located on our website.

### DIRECTIONAL COUPLER - DUAL BAND, SINGLE PATH

| Part Number   | Frequency (MHz)                  | Insertion Loss (max) | Return Loss (min)  | Coupling (dB)            | Isolation (min.)   | Case Size |
|---------------|----------------------------------|----------------------|--------------------|--------------------------|--------------------|-----------|
| 0869CP14B1050 | B1) 824 - 915<br>B2) 999 - 1102  | 0.4 dB<br>0.6 dB     | 15.5 dB<br>15.5 dB | 14.2 ± 1.0<br>12.7 ± 1.0 | 23.0 dB<br>22.0 dB | 14-1      |
| 0869CD14B1810 | B1) 824 - 915<br>B2) 1710 - 1910 | 0.4 dB<br>0.4 dB     | 14.0 dB<br>14.0 dB | 19.5 ± 1.0<br>19.5 ± 1.0 | 30.0 dB<br>30.0 dB | 14-1      |

### DIRECTIONAL COUPLER - DUAL BAND, DUAL PATH

| Part Number   | Frequency (MHz)                  | Insertion Loss (max) | Return Loss (min)  | Coupling (dB)            | Isolation (min.)   | Case Size |
|---------------|----------------------------------|----------------------|--------------------|--------------------------|--|-----------|
| 0869CD14A1810 | B1) 824 - 915<br>B2) 1710 - 1910 | 0.40 dB<br>0.40 dB   | -                  | 19.5 ± 1.0<br>19.5 ± 1.0 | B1 In > Term: 30.0 dB<br>B2 In > Term: 30.0 dB   | 14-1      |
| 0898CD15B1748 | B1) 880 - 915<br>B2) 1710 - 1785 | 0.40 dB<br>0.40 dB   | 10.9 dB<br>10.9 dB | 19.2 ± 1.0<br>19.2 ± 1.0 | B1 In > B2 Out: 35.0 dB<br>B1 In > B2 In: 25.0 dB<br>B1 Out > B2 In: 25.0 dB<br>B1 In > Term: 23.0 dB<br>B2 In > Term: 23.0 dB | 15-2      |
| 0898CD15C1748 | B1) 880-915<br>B2) 1710-1785     | 0.35 dB<br>0.45 dB   | 10.9 dB<br>10.9 dB | 19.2 ± 1.0<br>14.0 ± 1.5 | B1 In > B2 Out: 35.0 dB<br>B1 In > B2 In: 24.0 dB<br>B1 Out > B2 In: 24.0 dB<br>B1 In > Term: 24.0 dB<br>B2 In > Term: 24.0 dB | 15-2      |
| 0898CD15D1748 | B1) 1710-1785<br>B2) 880-915     | 0.50 dB<br>0.35 dB   | 14.0 dB<br>14.0 dB | 14.0 ± 1.5<br>19.2 ± 1.0 | B1 In > B2 Out: 25.5 dB<br>B1 In > B2 In: 21.0 dB<br>B1 Out > B2 In: 22.0 dB<br>B1 In > Term: 17.0 dB<br>B2 In > Term: 24.0 dB | 15-2      |

### DIRECTIONAL COUPLER WITH LOW PASS FILTER

| Part Number   | Frequency (MHz) | Insertion Loss (max) | Return Loss (min) | Coupling (dB) | Isolation (min.) | Attenuation (min.)   |         | Case Size      |
|---------------|-----------------|----------------------|-------------------|---------------|------------------|--|---------|----------------|
|               |                 |                      |                   |               |                  | 2 x Fo   | 3 x Fo  |                |
| 0898CF15A035_ | 880 - 915       | 0.7 dB               | 14 dB             | 20 ± 1.0      | 25.0 dB          | 22.0 dB  | 17.0 dB | 15-1           |
| 0910CF15B0100 | 860 - 960       | 1.2 dB               | 20 dB             | 10 ± 1.0      | 30.0 dB          | 27 dB @ 2 x Fo<br>30 dB @ 3 x Fo<br>30 dB @ 4 x Fo<br>30 dB @ 5 x Fo |         | See Spec Sheet |
| 1748CF15A075_ | 1710 - 1785     | 0.5 dB               | 14 dB             | 20 ± 1.0      | 25.0 dB          | 22.0 dB  |         | 15-1           |
| 2450CF15A0100 | 2400 - 2500     | 0.8 dB               | 20 dB             | 15 ± 1.0      | 22.0 dB          | 20.0 dB  |         | 15-1           |
| 5300CF15A0950 | 4900 - 5850     | 0.8 dB               | 20 dB             | 15 ± 1.0      | 22.0 dB          | 20.0 dB  |         | 15-1           |

Basic case size drawings for above part numbers are located on pages 39-40.

Detailed specifications and performance curves for the RF Ceramic Component line are located on our website.

## DIRECTIONAL COUPLER - SPLITTER, 3 dB HYBRID

| Part Number   | Frequency (MHz) | Insertion Loss (max) | Return Loss (min) | Isolation (min.) | Case Size |
|---------------|-----------------|----------------------|-------------------|------------------|-----------|
| 0880CH15A060  | 850 - 910       | 3.3 ± 0.5 dB         | 14.0 dB           | 20.0 dB          | 15-4      |
| 1472CH15A050  | 1452 - 1492     | 3.3 ± 0.5 dB         | 14.0 dB           | 16.0 dB          | 15-4      |
| 1950CH15A100  | 1900 - 2000     | 3.3 ± 0.5 dB         | 14.0 dB           | 16.0 dB          | 15-4      |
| 2450CH15A0100 | 2400 - 2500     | 3.3 ± 0.5 dB         | 14.0 dB           | 15.0 dB          | 15-4      |

## CERAMIC CHIP BALUNS

| Part Number   | Frequency (MHz) | Impedance Unbal./Bal. | Insertion Loss (max) | Return Loss (min) | Phase Difference | Amplitude Difference (max) | Case Size      |
|---------------|-----------------|-----------------------|----------------------|-------------------|------------------|----------------------------|----------------|
| 0430BL15A0100 | 400 - 460       | 50/100                | 1.0 dB               | 9.5 dB            | 180°±10°         | 2.0 dB                     | 15-1           |
| 0465BL15B100  | 460 - 470       | 50/100                | 1.0 dB               | 9.5 dB            | 180°±10°         | 1.5 dB                     | 15-1A          |
| 0896BL14B050  | 851 - 941       | 50/50                 | 1.5 dB               | 9.5 dB            | 180°±10°         | 0.7 dB                     | 14-1A          |
| 0866BL15C200  | 800 - 900       | 50/200                | 1.2 dB               | 9.5 dB            | 180°±10°         | 1.0 dB                     | 15-1E          |
| 0900BL15C050  | 800 - 1000      | 50/50                 | 1.2 dB               | 9.5 dB            | 180°±10°         | 2.0 dB                     | 15-1D          |
| 0900BL18B100  | 800 - 1000      | 50/100                | 1.0 dB               | 9.5 dB            | 180°±10°         | 2.0 dB                     | 18-1           |
| 0900BL18B200  | 800 - 1000      | 50/200                | 1.0 dB               | 9.5 dB            | 180°±10°         | 2.0 dB                     | 18-1           |
| 0900BL15A100  | 900 - 1000      | 50/100                | 1.2 dB               | 9.5 dB            | 180°±10°         | 2.0 dB                     | 15-1           |
| 0917BL18B100  | 889 - 945       | 50/100                | 1.0 dB               | 9.5 dB            | 180°±10°         | 2.0 dB                     | 18-1           |
| 1450BL15A200  | 1400 - 1500     | 50/200                | 1.0 dB               | 9.5 dB            | 180°±10°         | 2.0 dB                     | 15-1C          |
| 1472BL15B0100 | 1452 - 1492     | 50/100                | 1.0 dB               | 9.5 dB            | 180°±10°         | 2.0 dB                     | 15-1A          |
| 1600BL15B050  | 1500 - 1700     | 50/50                 | 1.0 dB               | 9.5 dB            | 180°±10°         | 2.0 dB                     | 15-1B          |
| 1600BL15B100  | 1500 - 1700     | 50/100                | 1.0 dB               | 9.5 dB            | 180°±10°         | 2.0 dB                     | 15-1B          |
| 1800BL18B200  | 1700 - 1900     | 50/200                | 0.8 dB               | 9.5 dB            | 180°±10°         | 2.0 dB                     | 18-1           |
| 1850BL15B050  | 1700 - 2000     | 50/50                 | 1.0 dB               | 9.5 dB            | 180°±10°         | 2.0 dB                     | 15-1B          |
| 1850BL15B100  | 1700 - 2000     | 50/100                | 1.0 dB               | 9.5 dB            | 180°±10°         | 2.0 dB                     | 15-1B          |
| 1850BL15B200  | 1700 - 2000     | 50/200                | 1.0 dB               | 9.5 dB            | 180°±10°         | 2.0 dB                     | 15-1B          |
| 2100BL18B200  | 2000 - 2200     | 50/200                | 0.8 dB               | 9.5 dB            | 180°±10°         | 2.0 dB                     | 18-1           |
| 2100BL15A100  | 2100 - 2200     | 50/100                | 1.0 dB               | 9.5 dB            | 180°±10°         | 2.0 dB                     | 15-1           |
| 2450BL07A0100 | 2400 - 2500     | 50/100                | 1.3 dB               | 9.5 dB            | 180°±10°         | 2.0 dB                     | See Spec Sheet |
| 2450BL14B050  | 2400 - 2500     | 50/50                 | 1.5 dB               | 9.5 dB            | 180°±10°         | 2.0 dB                     | 14-1A          |
| 2450BL14B100  | 2400 - 2500     | 50/100                | 1.3 dB               | 9.5 dB            | 180°±10°         | 2.0 dB                     | 14-1A          |
| 2450BL14C050  | 2400 - 2500     | 50/50                 | 1.2 dB               | 9.5 dB            | 180°±10°         | 2.0 dB                     | 14-1A          |
| 2450BL14C100  | 2400 - 2500     | 50/100                | 1.2 dB               | 9.5 dB            | 180°±10°         | 1.5 dB                     | 14-1A          |
| 2450BL14B200  | 2400 - 2500     | 50/200                | 1.2 dB               | 9.5 dB            | 180°±10°         | 2.0 dB                     | 14-1A          |
| 2450BL14C200  | 2400 - 2500     | 50/200                | 1.3 dB               | 9.5 dB            | 180°±10°         | 2.0 dB                     | 14-1A          |
| 2450BL15B050  | 2400 - 2500     | 50/50                 | 1.0 dB               | 9.5 dB            | 180°±10°         | 2.0 dB                     | 15-1C          |
| 2450BL15B100  | 2400 - 2500     | 50/100                | 1.0 dB               | 9.5 dB            | 180°±10°         | 2.0 dB                     | 15-1C          |
| 2450BL15B150  | 2400 - 2500     | 50/150                | 1.0 dB               | 9.5 dB            | 180°±10°         | 2.0 dB                     | 15-1A          |
| 2450BL15B200  | 2400 - 2500     | 50/200                | 1.0 dB               | 9.5 dB            | 180°±10°         | 2.0 dB                     | 15-1C          |
| 2450BL15K050  | 2400 - 2500     | 50/50                 | 1.2 dB               | 9.5 dB            | 180°±10°         | 2.0 dB                     | 15-1C          |
| 2450BL15K100  | 2400 - 2500     | 50/100                | 1.0 dB               | 9.5 dB            | 180°±10°         | 2.0 dB                     | 15-1C          |
| 2500BL14M050  | 2300 - 2700     | 50/50                 | 1.2 dB               | 9.5 dB            | 180°±15°         | 1.5 dB                     | 14-1A          |
| 2500BL14M100  | 2300 - 2700     | 50/100                | 1.2 dB               | 9.5 dB            | 180°±15°         | 1.5 dB                     | 14-1A          |

Basic case size drawings for above part numbers are located on pages 39-40.

Detailed specifications and performance curves for the RF Ceramic Component line are located on our website.

## CERAMIC CHIP BALUNS

| Part Number    | Frequency (MHz) | Impedance Unbal./Bal. | Insertion Loss (max) | Return Loss (min) | Phase Difference | Amplitude Difference (max) | Case Size |
|----------------|-----------------|-----------------------|----------------------|-------------------|------------------|----------------------------|-----------|
| 3600BL14M050   | 3300 - 3900     | 50/50                 | 1.2 dB               | 9.5 dB            | 180°±15°         | 1.5 dB                     | 14-1A     |
| 3600BL14M100   | 3300 - 3900     | 50/100                | 1.2 dB               | 9.5 dB            | 180°±15°         | 1.5 dB                     | 14-1A     |
| 3700BL15B050   | 3400 - 4000     | 50/50                 | 1.2 dB               | 9.5 dB            | 180°±25°         | 2.0 dB                     | 15-1C     |
| 3700BL15B100   | 3400 - 4000     | 50/100                | 1.0 dB               | 9.5 dB            | 180°±20°         | 1.0 dB                     | 15-1C     |
| 3700BL15B200   | 3400 - 4000     | 50/200                | 1.2 dB               | 9.5 dB            | 180°±20°         | 1.0 dB                     | 15-1A     |
| 4000BL14U100   | 3100 - 4800     | 50/100                | 1.2 dB               | 9.5 dB            | 180°±20°         | 1.5 dB                     | 14-1A     |
| 5425BL07A0200  | 4900 - 5950     | 50/200                | 1.2 dB               | 9.5 dB            | 180°±15°         | 2.0 dB                     | 07-1      |
| 5250BL14B100   | 5150 - 5350     | 50/100                | 1.0 dB               | 9.5 dB            | 180°±15°         | 1.5 dB                     | 14-1A     |
| 5250BL15B100   | 5150 - 5350     | 50/100                | 1.2 dB               | 9.5 dB            | 180°±10°         | 2.0 dB                     | 15-1C     |
| 5325BL15B050   | 5150 - 5500     | 50/50                 | 1.0 dB               | 9.5 dB            | 180°±10°         | 2.0 dB                     | 15-1C     |
| 5388BL15B100   | 4900 - 5875     | 50/100                | 1.0 dB               | 9.5 dB            | 180°±10°         | 2.0 dB                     | 15-1      |
| 5400BL14B100   | 4900 - 5875     | 50/100                | 1.0 dB               | 9.5 dB            | 180°±10°         | 1.5 dB                     | 14-1A     |
| 5400BL15B050   | 4900 - 5900     | 50/50                 | 1.0 dB               | 9.5 dB            | 180°±10°         | 2.0 dB                     | 15-1      |
| 5400BL15B100   | 4900 - 5900     | 50/100                | 1.0 dB               | 9.5 dB            | 180°±10°         | 2.0 dB                     | 15-1C     |
| 5400BL15B200   | 4900 - 5875     | 50/200                | 1.0 dB               | 9.5 dB            | 180°±10°         | 2.0 dB                     | 15-1B     |
| 5400BL15K050   | 4900 - 5875     | 50/50                 | 1.2 dB               | 8.5 dB            | 180°±10°         | 2.0 dB                     | 15-1A     |
| 5500BL15U0100  | 3000 - 8000     | 50/100                | 1.8 dB               | 9.5 dB            | 180°±20°         | 2.0 dB                     | 15-1A     |
| 5512BL15B100   | 5150 - 5875     | 50/100                | 1.0 dB               | 11.7 dB           | 180°±10°         | 2.0 dB                     | 15-1C     |
| 5512BL15B100_V | 5150 - 5875     | 50/100                | 1.0 dB               | 9.5 dB            | 180°±10°         | 2.0 dB                     | 15-1      |
| 5800BL15B100   | 5725 - 5875     | 50/100                | 1.0 dB               | 9.5 dB            | 180°±8°          | 0.75 dB                    | 15-1C     |
| 7128BL14A0100  | 6072 - 8184     | 50/100                | 1.0 dB               | 9.5 dB            | 180°±15°         | 1.5 dB                     | 14-1      |

## CERAMIC CHIP BALUNS, DUAL BAND

| Part Number  | Frequency (MHz)                  | Impedance Unbal./Bal. | Insertion Loss (max) | Return Loss (min) | Phase Difference     | Case Size      |
|--------------|----------------------------------|-----------------------|----------------------|-------------------|----------------------|----------------|
| 0918BD41B050 | B1: 900 - 940<br>B2: 1850 - 1920 | 50/50<br>50/50        | 1.2 dB<br>1.7 dB     | 8.5 dB<br>8.5 dB  | 180°±10°<br>180°±10° | 41-2           |
| 0918BD41D050 | B1: 900 - 940<br>B2: 1850 - 1920 | 50/50<br>50/50        | 1.2 dB<br>1.7 dB     | 8.5 dB<br>8.5 dB  | -                    | See Spec Sheet |

## SPECIFIC RF CHIPSET IMPEDEANCE-MATCHED BALUN/FILTERS INTEGRATED PASSIVES; REFERENCE DESIGNS

| Part Number   | Frequency (MHz) | Unbalanced Impedance | Differential Balanced Imp.           | Insertion Loss (max) | Return Loss (min) | Phase Difference |
|---------------|-----------------|----------------------|--------------------------------------|----------------------|-------------------|------------------|
| 0896BM15A0001 | 863 - 928       | 50                   | Conj match to T.I. CC11XX and CC430  | 1.5 dB               | 9.5 dB            | 180°±10°         |
| 0896FB15A0100 | 863 - 928       | 50                   | Conj match to AT86RF212              | 1.5 dB               | 9.5 dB            | 180°±10°         |
| 0953BM15A0001 | 950 - 956       | 50                   | Conj. match to T.I. CC11XX           | 2.1 dB               | 9.5 dB            | 180°±10°         |
| 2450BM15B0009 | 2400 - 2500     | 50                   | Conj match to ZIC2410                | 1.5 dB               | 9.5 dB            | 180°±10°         |
| 2450FB15K0002 | 2400 - 2500     | 50                   | Conj match to CSR BC03, BC04(16-j40) | 3 dB                 | 9.54 dB           | 180°±10°         |
| 2450FB15K0003 | 2400 - 2500     | 50                   | Conj match to CSR BC03, BC04(20-j50) | 3 dB                 | 9.54 dB           | 180°±10°         |
| 2450FB15K0004 | 2400 - 2500     | 50                   | Conj match to CSR BC03, BC04         | 3.2 dB               | 9.5 dB            | 180°±10°         |

Basic case size drawings for above part numbers are located on pages 39-40.

Detailed specifications and performance curves for the RF Ceramic Component line are located on our website.

## SPECIFIC RF CHIPSET IMPEDEANCE-MATCHED BALUN/FILTERS INTEGRATED PASSIVES; REFERENCE DESIGNS

| Part Number   | Frequency (MHz) | Unbalanced Impedance | Differential Balanced Imp.                    | Insertion Loss (max) | Return Loss (min) | Phase Difference |
|---------------|-----------------|----------------------|---|----------------------|-------------------|------------------|
| 2450FB15K0005 | 2400 - 2500     | 50                   | Conj match to BC series of CSR                | 3.5 dB               | 9.5 dB            | 180°±10°         |
| 2450FB15K0008 | 2400 - 2500     | 50                   | Conj match to BC series of CSR                | 3.5 dB               | 9.5 dB            | 180°±10°         |
| 2450FB15L0001 | 2400 - 2500     | 50                   | Imp. match to AT86RF230/231 & ATmega128RFA1   | 1.5 dB               | 9.5 dB            | 180°±10°         |
| 2450FB15M0001 | 2400 - 2500     | 50                   | Conj match to MTK and BC05 chipsets           | 3.0 dB               | 9.5 dB            | 180°±15°         |
| 2450BM14A0002 | 2400 - 2500     | 50                   | Conj match to nRF24L01/nRF24L01               | 2.0 dB               | 9.5 dB            | 160°±15°         |
| 2450BM15A0006 | 2400 - 2500     | 50                   | Conj match to STLC2690                        | 3.5 dB               | 14 dB             | 180°±10°         |
| 2450BM15A0001 | 2400 - 2500     | 50                   | Conj match to T.I. Chipsets CC2430 and CC2480 | 1.0 dB               | 10.0 dB           | 180°±15°         |
| 2450BM15B0003 | 2400 - 2500     | 50                   | Conj match to T.I. Chipset 2500               | 2.2 dB               | 10.0 dB           | 180°±12°         |
| 2450BM15B0002 | 2400 - 2500     | 50                   | Conjugate match to TI Chipset 2520            | 1.5 dB               | 10.0 dB           | 180°±15°         |
| 2450BM15A0002 | 2400 - 2500     | 50                   | Conjugate match to T.I. CC253X and CC2540     | 1.5 dB               | 10.0 dB           | 180°±15°         |

## CERAMIC CHIP BALUN FILTER

| Part Number   | Frequency (MHz) | Impedance Unbal./Bal.                               | Insertion Loss (max) | Return Loss (min) | Phase Difference | Case Size      |
|---------------|-----------------|---|----------------------|-------------------|------------------|----------------|
| 0783FB15A0100 | 779 - 787       | 50/100  | 1.5 dB               | 9.5 dB            | 180°±15°         | 15-1           |
| 0892FB15A0100 | 863 - 928       | 50/100  | 1.5 dB               | 11.7 dB           | 180°±15°         | 15-1           |
| 0896FB15A0100 | 868 - 915       | 50/100  | 1.5 dB               | 11.7 dB           | 180°±15°         | 15-1E          |
| 2345FB16A0100 | 2300 - 2390     | 50/100  | 2.8 dB               | 9.5 dB            | 180°±10°         | 15-1           |
| 2345FB39A0050 | 2300 - 2390     | 50/50   | 3.2 dB               | 11.7 dB           | 180°±10°         | 39-4B          |
| 2450FB14K0001 | 2400 - 2500     | 50 / 28+j64   | 3.5 dB               | 9.5 dB            | 180°±10°         | 14-1A          |
| 2450FB15A0100 | 2400 - 2500     | 50/100  | 1.5 dB               | 9.5 dB            | 180°±10          | 15-1           |
| 2450FB15K0001 | 2400 - 2500     | 50 / 16+j40   | 3.8 dB               | 9.5 dB            | 180°±10°         | 15-1           |
| 2450FB15K0002 | 2400 - 2500     | 50 / 16+j40   | 3.0 dB               | 9.54 dB           | 180°±10°         | 15-1           |
| 2450FB15K0003 | 2400 - 2500     | 50 / 20+j50   | 3.0 dB               | 9.5 dB            | 180°±10°         | 15-1           |
| 2450FB15K0004 | 2400 - 2500     | 50 / 28+j64   | 3.2 dB               | 9.5 dB            | 180°±10°         | 15-1           |
| 2450FB15A050  | 2400 - 2500     | 50/50   | 1.5 dB               | 9.5 dB            | 180°±10°         | 15-1           |
| 2450FB15M0001 | 2400 - 2500     | 50 / Conjugate match (20+j60) to MTK & BC05 Chipset | 3.0 dB               | 9.5 dB            | 180°±15°         | 15-1           |
| 2450FB39A050  | 2400 - 2500     | 50/50   | 2.0 dB               | 9.5 dB            | 180°±10°         | 39-2           |
| 2450FB39A0150 | 2400 - 2500     | 50/150  | 2.5 dB               | 9.5 dB            | 180°±10°         | 39-2           |
| 2450FB39B100  | 2400 - 2500     | 50/100  | 2.0 dB               | 9.5 dB            | 180°±10°         | 39-2           |
| 2450FB39K001  | 2400 - 2500     | 50 / 22+j100  | 3.0 dB               | 9.5 dB            | 180°± 8°         | See Spec Sheet |
| 2595FB39A0050 | 2500 - 2690     | 50/50   | 3.2 dB               | 11.73 dB          | 180°± 10°        | See Spec Sheet |
| 2450FB39C100  | 2400 - 2500     | 50/100  | 3.0 dB               | 9.5 dB            | 180°± 8°         | See Spec Sheet |
| 2500FB16A0400 | 2300 - 2690     | 50/50+2.4nH   | 3.8 dB               | 9.5 dB            | 180°± 10°        | See Spec Sheet |
| 2595FB16A0100 | 2300 - 2690     | 50/100  | 2.5 dB               | 9.5 dB            | 180°± 10°        | See Spec Sheet |
| 3500FB16A0100 | 3400 - 3600     | 50/100  | 2.7 dB               | 9.5 dB            | 180°± 10°        | See Spec Sheet |
| 3500FB39A0050 | 3400 - 3600     | 50/50   | 2.9 dB               | 9.5 dB            | 180°± 12°        | See Spec Sheet |

Basic case size drawings for above part numbers are located on pages 39-40.

Detailed specifications and performance curves for the RF Ceramic Component line are located on our website.

## CERAMIC CHIP DIPLEXERS - LPF / HPF

| Part Number    | Frequency (MHz)            | Insertion Loss (max) | Attenuation Low Band   | Attenuation High Band  | Return Loss (min) |
|----------------|----------------------------|----------------------|--|--|-------------------|
| 0859DP18A1920_ | 824 - 894<br>1850 - 1990   | 0.75 dB<br>0.55 dB   | 20 dB min  | 20 dB min  | 12 dB             |
| 0859DP18B1920  | 824 - 894<br>1850 - 1990   | 0.6 dB<br>0.65 dB    | 20 dB min  | 20 dB min  | 12 dB             |
| 0892DP14A1850_ | 824 - 960<br>1710 - 1990   | 0.5 dB<br>0.8 dB     | 15 dB min  | 25 dB min  | 12 dB             |
| 0892DP14B1850  | 824 - 960<br>1710 - 1990   | 0.6 dB<br>0.9 dB     | 15 dB min  | 20 dB min  | 9.5 dB            |
| 0892DP15A1940  | 824 - 960                  | 0.7 dB               | 16 min. @<br>1648 - 1830 MHz<br>22 min. @<br>2472 - 2745 MHz<br>15 min. @<br>3300 - 3680 MHz<br>12 min. @<br>4100 - 4600 MHz   | 18 min. @<br>3420 - 3820 MHz<br>20 min. @<br>5130 - 5730 MHz<br>15 min. @<br>6800 - 7680 MHz | 15 dB             |
|                | 1710 - 1990                | 0.8 dB               | 15 min. @<br>4920 - 5520 MHz<br>15 min. @<br>5740 - 6440 MHz<br>15 min. @<br>6560 - 7360 MHz<br>18 min. @<br>3420 - 3820 MHz<br>20 min. @<br>5130 - 5730 MHz<br>15 min. @<br>6800 - 7680 MHz |  |                   |
| 0892DP15D1940  | 824 - 960                  | 0.7 dB               | 16 min. @<br>1648 - 1830 MHz<br>22 min. @<br>2472 - 2745 MHz<br>15 min. @<br>3300 - 3680 MHz<br>12 min. @<br>4100 - 4600 MHz   | 18 min. @<br>3420 - 3820 MHz<br>20 min. @<br>5130 - 5730 MHz<br>15 min. @<br>6800 - 7680 MHz | 15 dB             |
|                | 1710 - 1990                | 0.8 dB               | 15 min. @<br>4920 - 5520 MHz<br>15 min. @<br>5740 - 6440 MHz<br>15 min. @<br>6560 - 7360 MHz<br>18 min. @<br>3420 - 3820 MHz<br>20 min. @<br>5130 - 5730 MHz<br>15 min. @<br>6800 - 7680 MHz |  |                   |
| 0920DP18A1795_ | 880 - 960<br>1710 - 1880   | 0.75 dB<br>0.55 dB   | 20 dB min  | 20 dB min  | 12 dB             |
| 0967DP18A1795_ | 954 - 980<br>1710 - 1880   | 0.75 dB<br>0.55 dB   | 20 dB min.   | 20 dB min.   | 12 dB             |
| 2400DP39A5425  | 2300 - 2500<br>4900 - 5950 | 1.8 dB<br>1.5 dB     | 20 dB min  | 20 dB min  | 9.5 dB            |
| 2450DP15A5512  | 2400 - 2500<br>5150 - 5875 | 0.70 dB<br>0.90 dB   | 20 dB min  | 15 dB min  | 9.5 dB            |
| 2450DP15B5512  | 2400 - 2500<br>5150 - 5875 | 0.70 dB<br>0.90 dB   | 20 dB min  | 15 dB min  | 9.5 dB            |

Basic case size drawings for above part numbers are located on pages 39-40.

Detailed specifications and performance curves for the RF Ceramic Component line are located on our website.

## CERAMIC CHIP DIPLEXERS - LPF / BPF

| Part Number   | Frequency (MHz)            | Insertion Loss (max) | Attenuation Low Band   | Attenuation High Band  | Return Loss (min) |
|---------------|----------------------------|----------------------|--|--|-------------------|
| 0892DP15B1850 | 824 - 960<br>1710 - 1990   | 1.3 dB<br>1.35 dB    | 16 dB min @<br>1628 - 1830 MHz<br>30 dB min @<br>2472 - 2745 MHz<br>27 dB min @<br>3296 - 4575 MHz | 18 dB min @<br>824 - 960 MHz<br>20 dB min @<br>3420 - 3820 MHz<br>27 dB min @<br>5130 - 5730 MHz | 9.5 dB            |
| 2450DP15D5400 | 2400 - 2500<br>4900 - 5875 | 0.7 dB<br>1.4 dB     | 20 dB min. @<br>4.8 - 6.0 GHz<br>20 dB min. @<br>7.2 - 7.5 GHz                                     | 19 dB min @<br>1.8 - 2.5 GHz<br>20 dB min. @<br>10.3 - 10.7 GHz                                  | 9.5 dB            |
| 2450DP15E5400 | 2400 - 2500<br>4900 - 5900 | 0.7 dB<br>1.6 dB     | 20 dB min @<br>4.8 - 6.0 GHz<br>17 dB min @<br>1.8 - 2.5 GHz                                       | 20 dB min @<br>7.2 - 7.5 GHz<br>20 dB typ. @<br>10.3 - 10.7 GHz                                  | 9.5 dB            |
| 2450DP15F5400 | 2400 - 2500<br>4900 - 5900 | 0.7 dB<br>1.0 dB     | 18 dB min @<br>4.8 - 6.0 GHz<br>19 dB min @<br>1.8 - 2.5 GHz                                       | 18 dB min @<br>7.2 - 7.5 GHz<br>25 dB typ. @<br>10.3 - 10.7 GHz                                  | 9.5 dB            |
| 2450DP15G5400 | 2400 - 2500<br>4900 - 5900 | 0.7 dB<br>1.0 dB     | 18 dB min @<br>4.8 - 6.0 GHz<br>19 dB min @<br>1.8 - 2.5 GHz                                       | 18 dB min @<br>7.2 - 7.5 GHz<br>25 dB typ. @<br>10.3 - 10.7 GHz                                  | 9.5 dB            |
| 2450DP15H5400 | 2400 - 2500<br>4900 - 5900 | 0.7 dB<br>1.0 dB     | 18 dB min @<br>4.8 - 6.0 GHz<br>19 dB min @<br>1.8 - 2.5 GHz                                       | 18 dB min @<br>7.2 - 7.5 GHz<br>25 dB typ. @<br>10.3 - 10.7 GHz                                  | 9.5 dB            |
| 2450DP15J5400 | 2400 - 2500<br>4900 - 5900 | 0.7 dB<br>1.0 dB     | 18 dB min @<br>4.8 - 6.0 GHz<br>19 dB min @<br>1.8 - 2.5 GHz                                       | 18 dB min @<br>7.2 - 7.5 GHz<br>25 dB typ. @<br>10.3 - 10.7 GHz                                  | 9.5 dB            |

## CERAMIC CHIP DIPLEXERS - BPF / NF

| Part Number   | Frequency (MHz) | Insertion Loss         | Attenuation                | Case Size      |
|---------------|-----------------|------------------------|----------------------------|----------------|
| 0500DP44A1215 | 950 - 1450      | 3.6 max. (25°C)        | 30.0 min. @ 200 - 750MHz   | See Spec Sheet |
|               |                 | 3.9 max. (-40 - +85°C) | 30.0 min. @ 1650 - 2150MHz |                |
|               | 200 - 750       | 2.0 max. (25°C)        | 30.0 min. @ 950 - 1450MHz  |                |
|               |                 | 2.3 max. (-40 - +85°C) |                            |                |
|               | 1650 - 2150     | 3.5 max. (25°C)        |                            |                |
|               |                 | 3.8 max. (-40 - +85°C) |                            |                |

## CERAMIC CHIP DIPLEXERS - BPF / NF

| Part Number   | Frequency (MHz) | Insertion Loss | Attenuation Low Band         | Attenuation High Band       | Return Loss |
|---------------|-----------------|----------------|------------------------------|-----------------------------|-------------|
| 1407DP15A2450 | 824 - 960       | 0.6 dB         | 15 min. @<br>2400 - 2500 MHz | 20 min. @<br>824 - 1990 MHz | 9.5 dB min. |
|               | 1710 - 1880     | 1.0 dB         |                              |                             | 9.5 dB min. |
|               | 1990            | 1.5 dB         |                              |                             | -           |
|               | 2400 - 2500     | 2.0 dB         |                              |                             | 9.5 dB min. |

Basic case size drawings for above part numbers are located on pages 39-40.

Detailed specifications and performance curves for the RF Ceramic Component line are located on our website.

Case 18-4

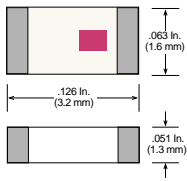

Case 42-1

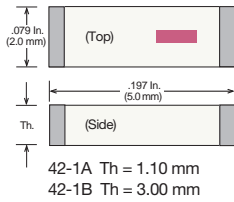

Case 42-2

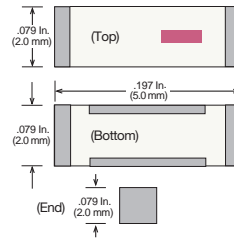

Case 43-1

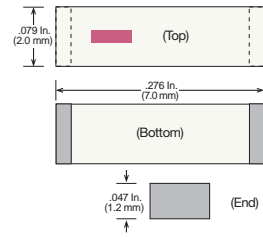

Case 43-2

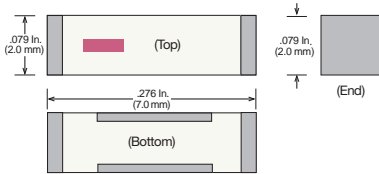

Case 43-3

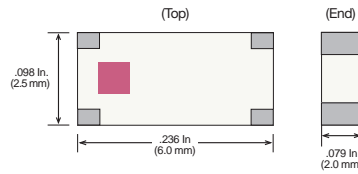

Case 44-1

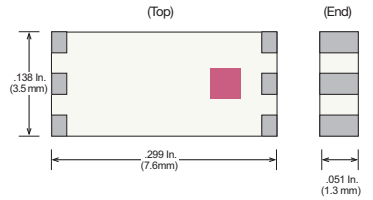

Case 44-2

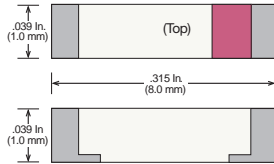

Case 45-1

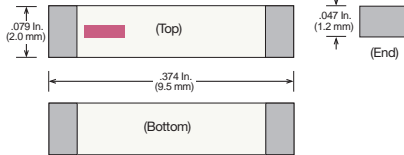

Case 46-1

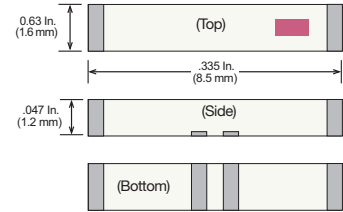

Case 47-1

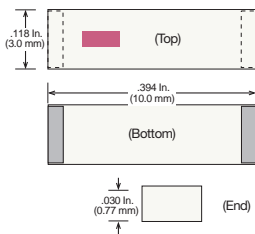

Case 50

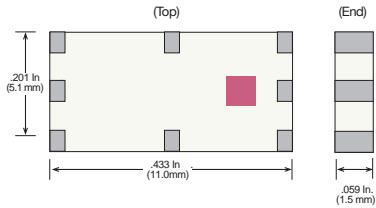

Case 51-1

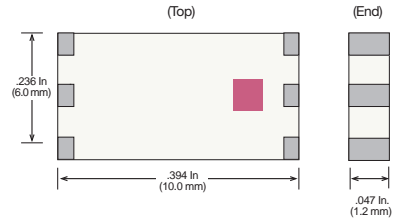

IPC EXCEPT ANTENNA

Case 07-1 (EIA 0402/ 1005)

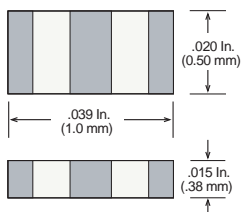

Case 07-2 (EIA 0402/ 1005)

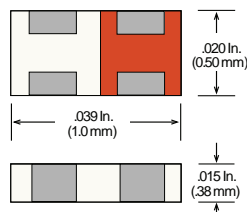

Case 14-1 (EIA 0603/ 1608)

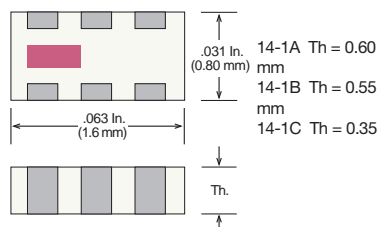

Case 14-2

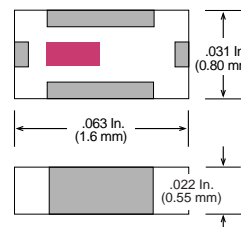



Case 15-1 (EIA 0805 / 2012)

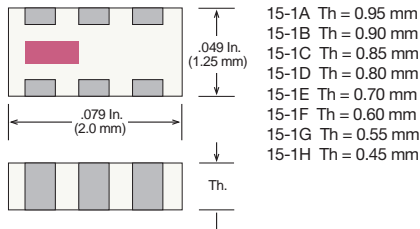

Case 15-2 (EIA 0805 / 2012)

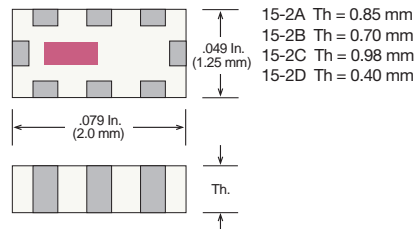

Case 15-3 (EIA 0805 / 2012)

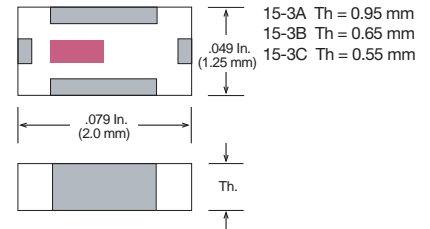

Case 15-4 (EIA 0805 / 2012)

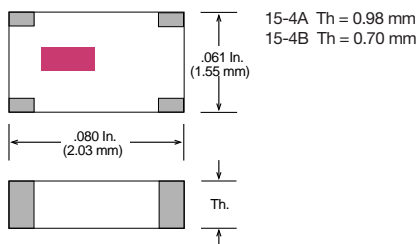

Case 18-1 (EIA 1206 / 3216)

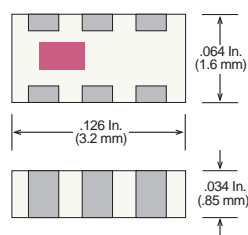

Case 18-2 (EIA 1206 / 3216)

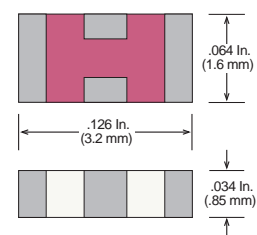

Case 18-3 (EIA 1206 / 3216)

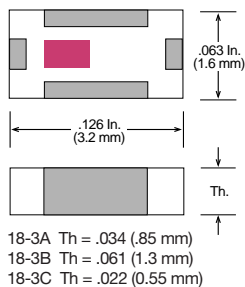

Case 18-4 (EIA 1206 / 3216)

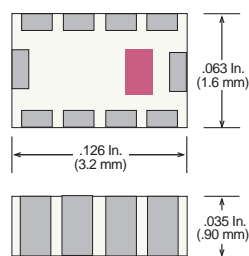

Case 39-1 (2520)

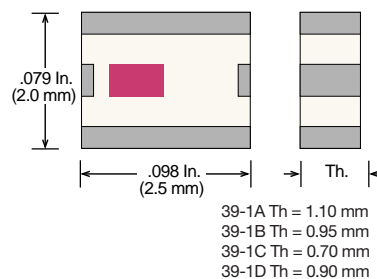

Case 39-2 (2520)

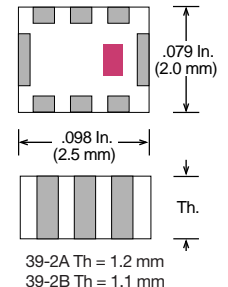

Case 39-3 (2520)

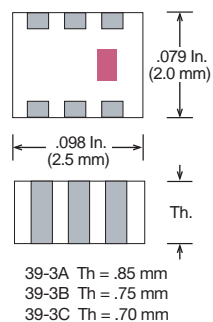

Case 39-4 (2520)

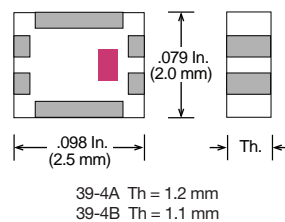

Case 41-1 (EIA 1210 / 3225)

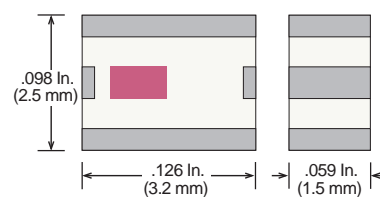

Case 41-2 (EIA 1210 / 3225)

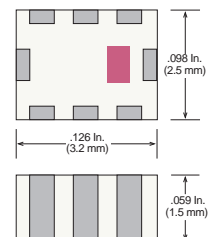

Detailed specifications and performance curves for the RF Ceramic Component line are located on our website.



Компания «ЭлектроПласт» предлагает заключение долгосрочных отношений при поставках импортных электронных компонентов на взаимовыгодных условиях!

Наши преимущества:

- Оперативные поставки широкого спектра электронных компонентов отечественного и импортного производства напрямую от производителей и с крупнейших мировых складов;
- Поставка более 17-ти миллионов наименований электронных компонентов;
- Поставка сложных, дефицитных, либо снятых с производства позиций;
- Оперативные сроки поставки под заказ (от 5 рабочих дней);
- Экспресс доставка в любую точку России;
- Техническая поддержка проекта, помощь в подборе аналогов, поставка прототипов;
- Система менеджмента качества сертифицирована по Международному стандарту ISO 9001;
- Лицензия ФСБ на осуществление работ с использованием сведений, составляющих государственную тайну;
- Поставка специализированных компонентов (Xilinx, Altera, Analog Devices, Intersil, Interpoint, Microsemi, Aeroflex, Peregrine, Syfer, Eurofarad, Texas Instrument, Miteq, Cobham, E2V, MA-COM, Hittite, Mini-Circuits, General Dynamics и др.);

Помимо этого, одним из направлений компании «ЭлектроПласт» является направление «Источники питания». Мы предлагаем Вам помощь Конструкторского отдела:

- Подбор оптимального решения, техническое обоснование при выборе компонента;
- Подбор аналогов;
- Консультации по применению компонента;
- Поставка образцов и прототипов;
- Техническая поддержка проекта;
- Защита от снятия компонента с производства.



#### Как с нами связаться

**Телефон:** 8 (812) 309 58 32 (многоканальный)

**Факс:** 8 (812) 320-02-42

**Электронная почта:** [org@eplast1.ru](mailto:org@eplast1.ru)

**Адрес:** 198099, г. Санкт-Петербург, ул. Калинина, дом 2, корпус 4, литера А.