

Low-power dual operational amplifier



DFN8 2x2



MiniSO8



TSSOP8

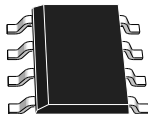

SO8

Features

- Frequency compensation implemented internally
- Large DC voltage gain: 100 dB
- Wide bandwidth (unity gain): 1.1 MHz (temperature compensated)
- Very low supply current/amplifier, essentially independent of supply voltage
- Low input bias current: 20 nA (temperature compensated)
- Low input offset current: 2 nA
- Input common-mode voltage range includes negative rail
- Differential input voltage range equal to the power supply voltage
- Large output voltage swing 0 V to $[(V_{CC}^+) - 1.5 V]$

Description

This circuit consists of two independent, high gain operational amplifiers (op amps) that have frequency compensation implemented internally. They are designed specifically for automotive and industrial control systems. The circuit operates from a single power supply over a wide range of voltages. The low power supply drain is independent of the magnitude of the power supply voltage.

Application areas include transducer amplifiers, DC gain blocks and all the conventional op amp circuits which can now be more easily implemented in single power supply systems. For example, these circuits can be directly supplied from the standard 5 V which is used in logic systems and easily provides the required electronic interfaces without requiring any additional power supply.

In linear mode, the input common-mode voltage range includes ground and the output voltage can also swing to ground, even though operated from a single power supply.

Maturity status link		
	Enhanced V_{IO}	Enhanced ESD
LM2904		
LM2904A	✓	
LM2904W		✓
LM2904AW	✓	✓

Related products	
TSB572	Dual op-amps for low-power consumption (380 μ A with 2.5 MHz GBP)
LM2902 LM2902W	Quad op-amps version
LM2904WH LM2904AH	High temperature version (150 °C)

1 Schematic diagram

Figure 1. Schematic diagram (LM2904, LM2904A)



Figure 2. Schematic diagram (LM2904W, LM2904AW)



2 Package pin connections

Figure 3. DFN8 2x2 package pin connections (top view)



1. The exposed pad of the DFN8 2x2 can be connected to (VCC-) or left floating.

Figure 4. MiniSO8, TSSOP8, and SO8 package pin connections (top view)



3 Absolute maximum ratings and operating conditions

Table 1. Absolute maximum ratings

Symbol	Parameter	Value	Unit	
V_{CC}	Supply voltage ⁽¹⁾	± 16 or 32	V	
V_{id}	Differential input voltage (LM2904, LM2904A) ⁽²⁾	± 32		
	Differential input voltage (LM2904W, LM2904AW) ⁽²⁾	-0.3 to $V_{CC} + 0.3$		
V_{in}	Input voltage (LM2904, LM2904A)	-0.3 to 32		
	Input voltage (LM2904W, LM2904AW)	-0.3 to $V_{CC} + 0.3$		
	Output short-circuit duration ⁽³⁾	Infinite	s	
I_{in}	Input current : V_{in} driven negative	5 mA in DC or 50 mA in AC, (duty cycle = 10 %, T = 1 s)	mA	
	Input current : V_{in} driven positive above AMR value ⁽⁵⁾	0.4		
T_{oper}	Operating free-air temperature range	-40 to 125	°C	
T_{stg}	Storage temperature range	-65 to 150		
T_j	Maximum junction temperature	150		
R_{thja}	Thermal resistance junction to ambient ⁽⁶⁾	DFN8 2x2	57	°C/W
		MiniSO8	190	
		TSSOP8	120	
		SO8	125	
R_{thjc}	Thermal resistance junction to case ⁽⁶⁾	MiniSO8	39	
		TSSOP8	37	
		SO8	40	
ESD	HBM: human body model (LM2904, LM2904A) ⁽⁷⁾	300	V	
	HBM: human body model (LM2904W, LM2904AW) ⁽⁷⁾	2000		
	MM: machine model ⁽⁸⁾	200		
	CDM: charged device model ⁽⁹⁾	1.5	kV	

- All voltage values, except differential voltage are with respect to network ground terminal.
- Differential voltages are the non-inverting input terminal with respect to the inverting input terminal.
- Short-circuits from the output to V_{CC} can cause excessive heating if (V_{CC}^+) > 15 V. The maximum output current is approximately 40 mA, independent of the magnitude of V_{CC} . Destructive dissipation can result from simultaneous short-circuits on all amplifiers.
- This input current only exists when the voltage at any of the input leads is driven negative. It is due to the collector-base junction of the input PNP transistor becoming forward-biased and thereby acting as an input diode clamp. In addition to this diode action, there is NPN parasitic action on the IC chip. This transistor action can cause the output voltages of the op amps to go to the V_{CC} voltage level (or to ground for a large overdrive) for the time during which an input is driven negative. This is not destructive and normal output is restored for input voltages above -0.3 V.
- The junction base/substrate of the input PNP transistor polarized in reverse must be protected by a resistor in series with the inputs to limit the input current to 400 μ A max ($R = (V_{in} - 32 V)/400 \mu$ A).
- Short-circuits can cause excessive heating and destructive dissipation. Values are typical.
- Human body model: a 100 pF capacitor is charged to the specified voltage, then discharged through a 1.5 k Ω resistor between two pins of the device. This is done for all couples of connected pin combinations while the other pins are floating.
- Machine model: a 200 pF capacitor is charged to the specified voltage, then discharged directly between two pins of the device with no external series resistor (internal resistor < 5 Ω). This is done for all couples of connected pin combinations while the other pins are floating.

9. *Charged device model: all pins and the package are charged together to the specified voltage and then discharged directly to the ground through only one pin. This is done for all pins.*

Table 2. Operating conditions

Symbol	Parameter	Value	Unit
V_{CC}	Supply voltage	3 to 30	V
V_{icm}	Common mode input voltage range $T_{amb} = 25\text{ °C}$	V_{CC-} to $V_{CC+} - 1.5$	
	Common mode input voltage range $T_{min} \leq T_{amb} \leq T_{max}$	V_{CC-} to $V_{CC+} - 2$	
T_{oper}	Operating free-air temperature range	-40 to 125	°C

4 Electrical characteristics

Table 3. $V_{CC+} = 5\text{ V}$, $V_{CC-} = \text{ground}$, $V_O = 1.4\text{ V}$, R_L connected to GND, $T_{\text{amb}} = 25\text{ }^\circ\text{C}$ (unless otherwise specified)

Symbol	Parameter	Min.	Typ.	Max.	Unit
V_{io}	Input offset voltage, $T_{\text{amb}} = 25\text{ }^\circ\text{C}$, LM2904, LM2904W ⁽¹⁾		2	7	mV
	Input offset voltage, $T_{\text{amb}} = 25\text{ }^\circ\text{C}$, LM2904A, LM2904AW ⁽¹⁾		1	2	
	Input offset voltage, $T_{\text{min}} \leq T_{\text{amb}} \leq T_{\text{max}}$, LM2904, LM2904W ⁽¹⁾			9	
	Input offset voltage, $T_{\text{min}} \leq T_{\text{amb}} \leq T_{\text{max}}$, LM2904A, LM2904AW ⁽¹⁾			4	
$\Delta V_{io}/\Delta T$	Input offset voltage drift		7	30	$\mu\text{V}/^\circ\text{C}$
I_{io}	Input offset current, $T_{\text{amb}} = 25\text{ }^\circ\text{C}$		2	30	nA
	Input offset current, $T_{\text{min}} \leq T_{\text{amb}} \leq T_{\text{max}}$			40	
$\Delta I_{io}/\Delta T$	Input offset current drift		10	300	$\text{pA}/^\circ\text{C}$
I_{ib}	Input bias current, $T_{\text{amb}} = 25\text{ }^\circ\text{C}$ ⁽²⁾		20	150	nA
	Input bias current, $T_{\text{min}} \leq T_{\text{amb}} \leq T_{\text{max}}$ ⁽²⁾			200	
A_{vd}	Large signal voltage gain, $V_{CC+} = 15\text{ V}$, $R_L = 2\text{ k}\Omega$, $V_O = 1.4\text{ V}$ to 11.4 V , $T_{\text{amb}} = 25\text{ }^\circ\text{C}$	50	100		V/mV
	Large signal voltage gain, $V_{CC+} = 15\text{ V}$, $R_L = 2\text{ k}\Omega$, $V_O = 1.4\text{ V}$ to 11.4 V , $T_{\text{min}} \leq T_{\text{amb}} \leq T_{\text{max}}$	25			
SVR	Supply voltage rejection ratio, $V_{CC+} = 5\text{ V}$ to 30 V , $V_{icm} = 0\text{ V}$, $T_{\text{amb}} = 25\text{ }^\circ\text{C}$	65	100		dB
	Supply voltage rejection ratio, $V_{CC+} = 5\text{ V}$ to 30 V , $V_{icm} = 0\text{ V}$, $T_{\text{min}} \leq T_{\text{amb}} \leq T_{\text{max}}$	65			
I_{CC}	Supply current, all amp, no load, $T_{\text{amb}} = 25\text{ }^\circ\text{C}$, $V_{CC+} = 5\text{ V}$		0.7	1.2	mA
	Supply current, all amp, no load, $T_{\text{min}} \leq T_{\text{amb}} \leq T_{\text{max}}$, $V_{CC+} = 30\text{ V}$			2	
CMR	Common-mode rejection ratio, $V_{CC+} = 30\text{ V}$, $V_{icm} = 0\text{ V}$ to 28.5 V , $T_{\text{amb}} = 25\text{ }^\circ\text{C}$	70	85		dB
	Common-mode rejection ratio, $V_{CC+} = 30\text{ V}$, $V_{icm} = 0\text{ V}$ to 28 V , $T_{\text{min}} \leq T_{\text{amb}} \leq T_{\text{max}}$	60			
I_{source}	Output short-circuit current, $V_{CC+} = 15\text{ V}$, $V_O = 2\text{ V}$, $V_{id} = 1\text{ V}$	20	40	60	mA
I_{sink}	Output sink current, $V_O = 2\text{ V}$, $V_{CC+} = 15\text{ V}$	10	20		
	Output sink current, $V_O = 0.2\text{ V}$, $V_{CC+} = 15\text{ V}$	12	50		μA
V_{OH}	High-level output voltage ($V_{CC+} = 30\text{ V}$), $T_{\text{amb}} = 25\text{ }^\circ\text{C}$, $R_L = 2\text{ k}\Omega$	26			V
	High-level output voltage ($V_{CC+} = 30\text{ V}$), $T_{\text{min}} \leq T_{\text{amb}} \leq T_{\text{max}}$	26	27		
	High-level output voltage ($V_{CC+} = 30\text{ V}$), $T_{\text{amb}} = 25\text{ }^\circ\text{C}$, $R_L = 10\text{ k}\Omega$	27			
	High-level output voltage ($V_{CC+} = 30\text{ V}$), $T_{\text{min}} \leq T_{\text{amb}} \leq T_{\text{max}}$	27	28		
V_{OL}	Low-level output voltage ($R_L = 10\text{ k}\Omega$), $T_{\text{amb}} = 25\text{ }^\circ\text{C}$		5	20	mV
	Low-level output voltage ($R_L = 10\text{ k}\Omega$), $T_{\text{min}} \leq T_{\text{amb}} \leq T_{\text{max}}$			20	

Symbol	Parameter	Min.	Typ.	Max.	Unit
SR	Slew rate, $V_{CC}^+ = 15\text{ V}$, $V_{in} = 0.5\text{ to }3\text{ V}$, $R_L = 2\text{ k}\Omega$, $C_L = 100\text{ pF}$, unity gain, $T_{amb} = 25\text{ }^\circ\text{C}$	0.3	0.6		V/ μs
	Slew rate, $V_{CC}^+ = 15\text{ V}$, $V_{in} = 0.5\text{ to }3\text{ V}$, $R_L = 2\text{ k}\Omega$, $C_L = 100\text{ pF}$, unity gain, $T_{min} \leq T_{amb} \leq T_{max}$	0.2			
GBP	Gain bandwidth product, $f = 100\text{ kHz}$, $V_{CC}^+ = 30\text{ V}$, $V_{in} = 10\text{ mV}$, $R_L = 2\text{ k}\Omega$, $C_L = 100\text{ pF}$	0.7	1.1		MHz
THD	Total harmonic distortion, $f = 1\text{ kHz}$, $A_V = 20\text{ dB}$, $R_L = 2\text{ k}\Omega$, $V_o = 2\text{ V}_{pp}$, $C_L = 100\text{ pF}$, $V_{CC}^+ = 30\text{ V}$		0.02		%
e_n	Equivalent input noise voltage, $f = 1\text{ kHz}$, $R_S = 100\text{ }\Omega$, $V_{CC}^+ = 30\text{ V}$		55		nV/ $\sqrt{\text{Hz}}$
V_{O1}/V_{O2}	Channel separation, $1\text{ kHz} \leq f \leq 20\text{ kHz}$ ⁽³⁾		120		dB

- $V_O = 1.4\text{ V}$, $5\text{ V} < V_{CC}^+ < 30\text{ V}$, $0\text{ V} < V_{ic} < (V_{CC}^+) - 1.5\text{ V}$
- The direction of the input current is out of the IC. This current is essentially constant as long as the output is not saturated, so there is no change in the loading charge on the input lines.
- Due to the proximity of external components, ensure that the stray capacitance does not cause coupling between these external parts. This can typically be detected at higher frequencies because this type of capacitance increases.

5 Electrical characteristic curves

Figure 5. Open-loop frequency response



Figure 6. Large signal frequency response



Figure 7. Voltage follower large signal response



Figure 8. Current sinking output characteristics



Figure 9. Voltage follower small signal response



Figure 10. Current sourcing output characteristics

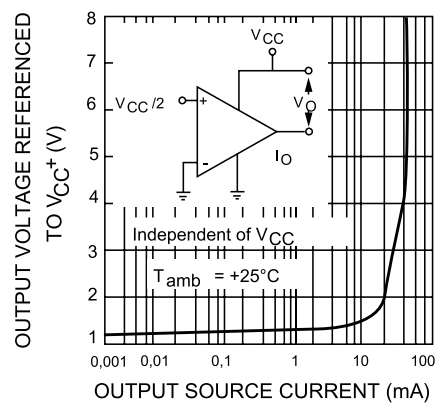

Figure 11. Input current vs. temperature

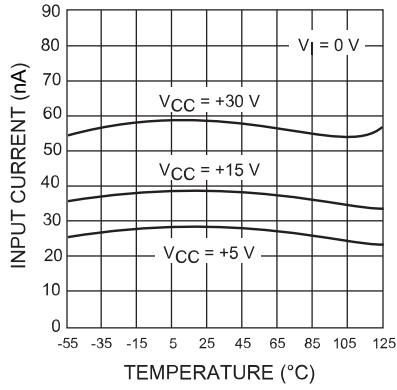

Figure 12. Current limiting

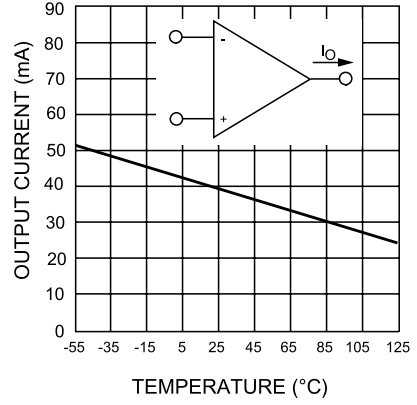

Figure 13. Input voltage range

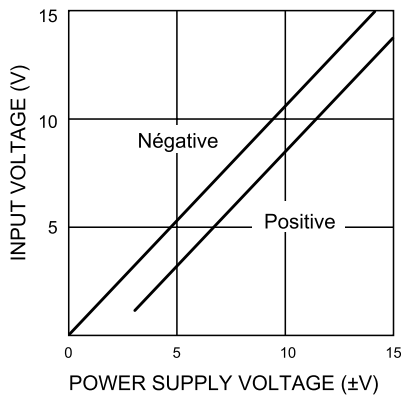

Figure 14. Supply current

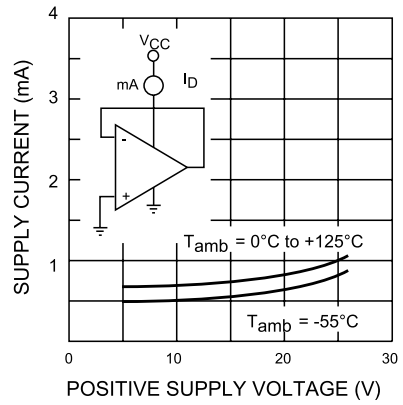

Figure 15. Voltage gain

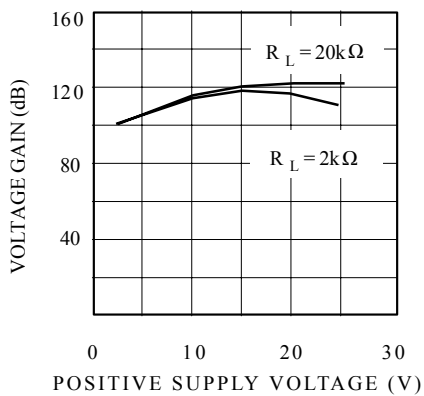

Figure 16. Input current vs. supply voltage

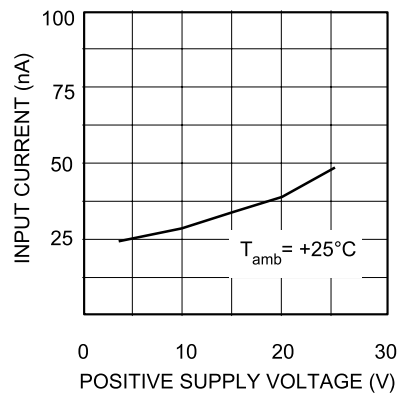

Figure 17. Gain bandwidth product

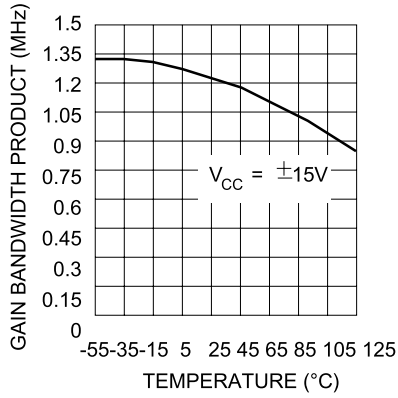

Figure 18. Power supply rejection ratio

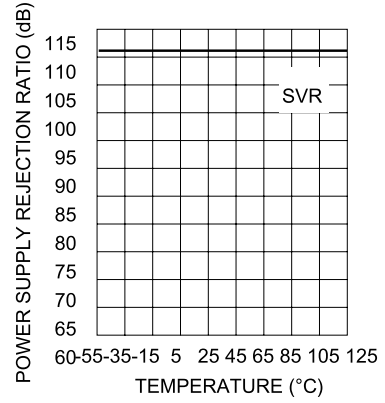

Figure 19. Common-mode rejection ratio



Figure 20. Phase margin vs. capacitive load



6 Typical single-supply applications

Figure 21. AC coupled inverting amplifier

Figure 22. AC coupled non-inverting amplifier

Figure 23. Non-inverting DC gain

Figure 24. DC summing amplifier

Figure 25. High input Z, DC differential amplifier

Figure 26. Using symmetrical amplifiers to reduce input current

Figure 27. Low drift peak detector

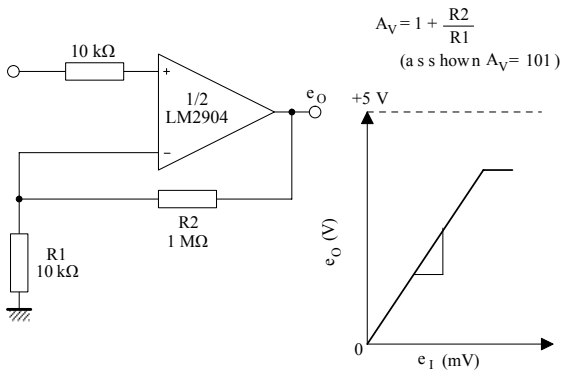
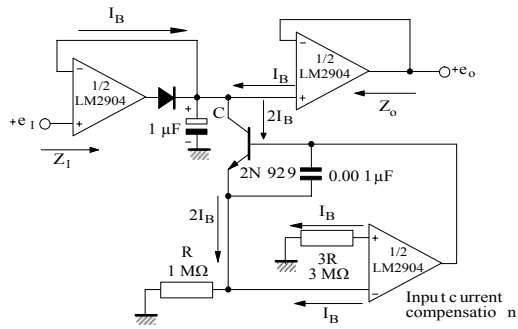
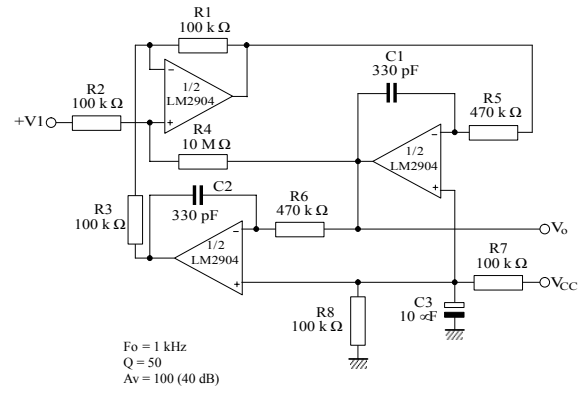

Figure 28. Active bandpass filter



7 Macromodel

An accurate macromodel of the LM2904, LM2904A is available on STMicroelectronics' web site at: www.st.com . This model is a trade-off between accuracy and complexity (that is, time simulation) of the LM2904, LM2904A operational amplifier. It emulates the nominal performances of a typical device within the specified operating conditions mentioned in the datasheet. It also helps to validate a design approach and to select the right operational amplifier, *but it does not replace on-board measurements*.

8 Package information

In order to meet environmental requirements, ST offers these devices in different grades of **ECOPACK[®]** packages, depending on their level of environmental compliance. ECOPACK[®] specifications, grade definitions and product status are available at: www.st.com. ECOPACK[®] is an ST trademark.

8.1 DFN8 2 x 2 package information

Figure 29. DFN8 2 x 2 package outline

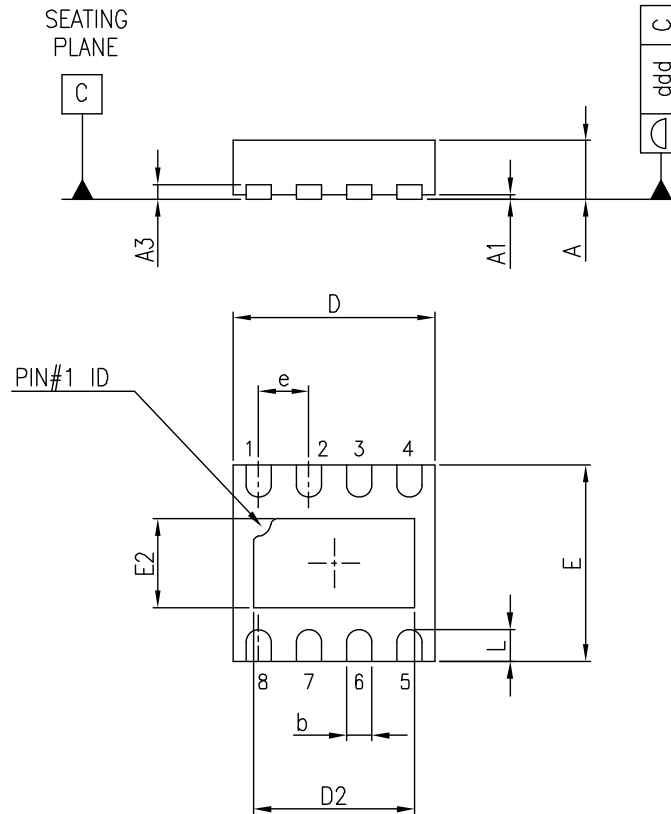
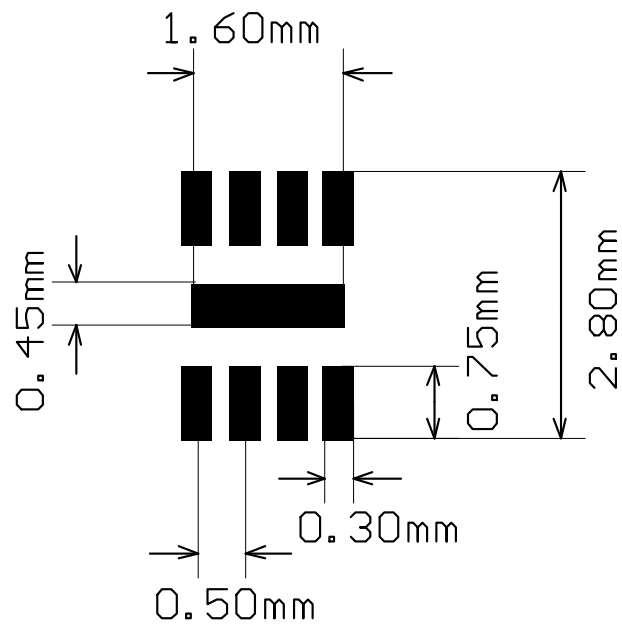

Table 4. DFN8 2 x 2 mechanical data

Ref.	Dimensions					
	Millimeters			Inches		
	Min.	Typ.	Max.	Min.	Typ.	Max.
A	0.51	0.55	0.60	0.020	0.022	0.024
A1			0.05			0.002
A3		0.15			0.006	
b	0.18	0.25	0.30	0.007	0.010	0.012
D	1.85	2.00	2.15	0.073	0.079	0.085
D2	1.45	1.60	1.70	0.057	0.063	0.067
E	1.85	2.00	2.15	0.073	0.079	0.085
E2	0.75	0.90	1.00	0.030	0.035	0.039
e		0.50			0.020	
L	0.225	0.325	0.425	0.009	0.013	0.017
ddd			0.08			0.003

Figure 30. DFN8 2 x 2 recommended footprint



8.2 MiniSO8 package information

Figure 31. MiniSO8 package outline

Table 5. MiniSO8 package mechanical data

Ref.	Dimensions					
	Millimeters			Inches		
	Min.	Typ.	Max.	Min.	Typ.	Max.
A			1.1			0.043
A1	0		0.15	0		0.0006
A2	0.75	0.85	0.95	0.030	0.033	0.037
b	0.22		0.40	0.009		0.016
c	0.08		0.23	0.003		0.009
D	2.80	3.00	3.20	0.11	0.118	0.126
E	4.65	4.90	5.15	0.183	0.193	0.203
E1	2.80	3.00	3.10	0.11	0.118	0.122
e		0.65			0.026	
L	0.40	0.60	0.80	0.016	0.024	0.031
L1		0.95			0.037	
L2		0.25			0.010	
k	0°		8°	0°		8°
ccc			0.10			0.004

8.3 TSSOP8 package information

Figure 32. TSSOP8 package outline

Ref.	Dimensions					
	Millimeters			Inches		
	Min.	Typ.	Max.	Min.	Typ.	Max.
A			1.20			0.047
A1	0.05		0.15	0.002		0.006
A2	0.80	1.00	1.05	0.031	0.039	0.041
b	0.19		0.30	0.007		0.012
c	0.09		0.20	0.004		0.008
D	2.90	3.00	3.10	0.114	0.118	0.122
E	6.20	6.40	6.60	0.244	0.252	0.260
E1	4.30	4.40	4.50	0.169	0.173	0.177
e		0.65			0.0256	
k	0°		8°	0°		8°
L	0.45	0.60	0.75	0.018	0.024	0.030
L1		1			0.039	
aaa			0.10			0.004

8.4 SO8 package information

Figure 33. SO8 package outline

Table 6. SO8 package mechanical data

Ref.	Dimensions					
	Millimeters			Inches		
	Min.	Typ.	Max.	Min.	Typ.	Max.
A			1.75			0.069
A1	0.10		0.25	0.004		0.010
A2	1.25			0.049		
b	0.28		0.48	0.011		0.019
c	0.17		0.23	0.007		0.010
D	4.80	4.90	5.00	0.189	0.193	0.197
E	5.80	6.00	6.20	0.228	0.236	0.244
E1	3.80	3.90	4.00	0.150	0.154	0.157
e		1.27			0.050	
h	0.25		0.50	0.010		0.020
L	0.40		1.27	0.016		0.050
L1		1.04			0.040	
k	0°		8°	0°		8°
ccc			0.10			0.004

9 Ordering information

Table 7. Order codes

Order code	Temperature range	Package	Packing	Marking
LM2904D	-40 °C to 125 °C	SO8	Tube	2904
LM2904DT		SO8	Tape and reel	
LM2904PT		TSSOP8		K403
LM2904ST		MiniSO8		K1Y
LM2904Q2T		DFN8 2x2		2904Y
LM2904YDT ⁽¹⁾		SO8 (automotive grade level)		2904AY
LM2904AYDT ⁽¹⁾		TSSOP8 (automotive grade level)		2904Y
LM2904YPT ⁽¹⁾				904AY
LM2904AYPT ⁽¹⁾		MiniSO8 (automotive grade level)		K409
LM2904YST ⁽¹⁾		SO8		2904W
LM2904WDT		SO8 (automotive grade level)		2904WY
LM2904WYDT ⁽¹⁾		TSSOP8 (automotive grade level)		K04WY
LM2904WYPT ⁽¹⁾				K05WY
LM2904AWYPT ⁽¹⁾				

1. Qualified and characterized according to AEC Q100 and Q003 or equivalent, advanced screening according to AEC Q001 & Q 002 or equivalent.

Revision history

Table 8. Document revision history

Date	Revision	Changes
02-Jan-2002	1	Initial release.
20-Jun-2005	2	PPAP references inserted in the datasheet, see Table 9 on page 21. ESD protection inserted in Table 1 on page 5.
10-Oct-2005	3	PPAP part numbers added in Table 9 on page 21.
12-Dec-2005	4	Pin connections identification added on cover page figure. Thermal resistance junction to case information added see Table 1 on page 5.
01-Feb-2006	5	Maximum junction temperature parameter added in Table 1 on page 5.
02-May-2006	6	Minimum slew rate parameter in temperature Table 3 on page 7.
13-Jul-2006	7	Modified ESD values and added explanation on V_{CC} , V_{id} in Table 1 on page 5. Added macromodel information.
28-Feb-2007	8	Modified ESD/HBM values in Table 1 on page 5. Updated MiniSO8 package information. Added note relative to automotive grade level part numbers in Table 9 on page 21.
18-Jun-2007	9	Power dissipation value corrected in Table 1: Absolute maximum ratings. Table 2: Operating conditions added. Equivalent input noise voltage parameter added in Table 3. Electrical characteristics curves updated. Figure 19: Phase margin vs capacitive load added. Section 6: Package information updated.
18-Dec-2007	10	Removed power dissipation parameter from Table 1: Absolute maximum ratings. Removed V_{opp} from electrical characteristics in Table 3. Corrected MiniSO8 package mechanical data in Section 6.4: MiniSO8 package information.
08-Apr-2008	11	Added table of contents. Corrected the scale of Figure 7 (mA not μ A). Corrected SO8 package information.
02-Jun-2009	12	Added input current information in Table 1: Absolute maximum ratings. Added L1 parameters in Table 6: SO8 package mechanical data. Added new order codes, LM2904AYD/DT, LM2904AYPT and LM2904AYST in Table 9: Order codes.
13-Apr-2010	13	Added LM2904A on cover page. Corrected footnote (5) in Table 1: Absolute maximum ratings. Removed order code LM2904AYST from Table 9: Order codes.
24-Jan-2012	14	Removed macromodel from Chapter 5 (now available on www.st.com). Added DFN8 2 x 2 mm package information in Chapter 6 and related order codes in Chapter 7. Removed LM2904YD and LM2904AYD order codes from Table 9. Changed note for LM2904YST order code in Table 9.
24-Jan-2014	15	Updated: marking info for LM2904AYPT, package silhouette drawings in the cover page, $\Delta V_{io}/\Delta T$ and $\Delta I_{io}/\Delta T$ symbols in Table 3 on page 7 Added: ESD info in Features section and Section 2: Package pin connections Removed: LM2904N from Table 9: Order codes.
02-Oct-2015	16	Figure 1: Schematic diagram (1/2 LM2904, LM2904A): updated

Date	Revision	Changes
16-Feb-2016	17	<p>Updated layout</p> <p>Removed "plastic micropackage" from SO8 and DFN8 2x2 package silhouettes; removed "thin shrink small outline package" from TSSOP8 package silhouette</p> <p>Table 3: unit of V_{OL} parameter changed from "V" to 'mV"</p> <p>DFN8 2x2 package information: updated "L"</p> <p>TSSOP8 package information: "aaa" is a typ. value not a max value</p>
15-Feb-2019	18	<p>Added new part numbers LM2904W, LM2904AW, Figure 2. Schematic diagram (LM2904W, LM2904AW) and Table 2. Operating conditions.</p> <p>Updated: Table 1. Absolute maximum ratings, Section 4 Electrical characteristics and Section 9 Ordering information</p>

Contents

1	Schematic diagram	2
2	Package pin connections	3
3	Absolute maximum ratings and operating conditions	4
4	Electrical characteristics	6
5	Electrical characteristic curves	8
6	Typical single-supply applications	11
7	Macromodel	13
8	Package information	14
8.1	DFN8 2 x 2 package information	15
8.2	MiniSO8 package information	17
8.3	TSSOP8 package information	17
8.4	SO8 package information	18
9	Ordering information	20
	Revision history	21
	Contents	23
	List of tables	24
	List of figures	25

List of tables

Table 1.	Absolute maximum ratings	4
Table 2.	Operating conditions	5
Table 3.	$V_{CC+} = 5\text{ V}$, $V_{CC-} = \text{ground}$, $V_O = 1.4\text{ V}$, R_L connected to GND, $T_{\text{amb}} = 25\text{ }^{\circ}\text{C}$ (unless otherwise specified)	6
Table 4.	DFN8 2 x 2 mechanical data	15
Table 5.	MiniSO8 package mechanical data	17
Table 6.	SO8 package mechanical data	19
Table 7.	Order codes	20
Table 8.	Document revision history	21

List of figures

Figure 1.	Schematic diagram (LM2904, LM2904A)	2
Figure 2.	Schematic diagram (LM2904W, LM2904AW)	2
Figure 3.	DFN8 2x2 package pin connections (top view)	3
Figure 4.	MiniSO8, TSSOP8, and SO8 package pin connections (top view)	3
Figure 5.	Open-loop frequency response	8
Figure 6.	Large signal frequency response	8
Figure 7.	Voltage follower large signal response	8
Figure 8.	Current sinking output characteristics	8
Figure 9.	Voltage follower small signal response	8
Figure 10.	Current sourcing output characteristics	8
Figure 11.	Input current vs. temperature	9
Figure 12.	Current limiting	9
Figure 13.	Input voltage range	9
Figure 14.	Supply current	9
Figure 15.	Voltage gain	9
Figure 16.	Input current vs. supply voltage	9
Figure 17.	Gain bandwidth product	10
Figure 18.	Power supply rejection ratio	10
Figure 19.	Common-mode rejection ratio	10
Figure 20.	Phase margin vs. capacitive load	10
Figure 21.	AC coupled inverting amplifier	11
Figure 22.	AC coupled non-inverting amplifier	11
Figure 23.	Non-inverting DC gain	11
Figure 24.	DC summing amplifier	11
Figure 25.	High input Z, DC differential amplifier	11
Figure 26.	Using symmetrical amplifiers to reduce input current	11
Figure 27.	Low drift peak detector	12
Figure 28.	Active bandpass filter	12
Figure 29.	DFN8 2 x 2 package outline	15
Figure 30.	DFN8 2 x 2 recommended footprint	16
Figure 31.	MiniSO8 package outline	17
Figure 32.	TSSOP8 package outline	18
Figure 33.	SO8 package outline	19

IMPORTANT NOTICE – PLEASE READ CAREFULLY

STMicroelectronics NV and its subsidiaries (“ST”) reserve the right to make changes, corrections, enhancements, modifications, and improvements to ST products and/or to this document at any time without notice. Purchasers should obtain the latest relevant information on ST products before placing orders. ST products are sold pursuant to ST’s terms and conditions of sale in place at the time of order acknowledgement.

Purchasers are solely responsible for the choice, selection, and use of ST products and ST assumes no liability for application assistance or the design of Purchasers’ products.

No license, express or implied, to any intellectual property right is granted by ST herein.

Resale of ST products with provisions different from the information set forth herein shall void any warranty granted by ST for such product.

ST and the ST logo are trademarks of ST. All other product or service names are the property of their respective owners.

Information in this document supersedes and replaces information previously supplied in any prior versions of this document.

© 2019 STMicroelectronics – All rights reserved



Компания «ЭлектроПласт» предлагает заключение долгосрочных отношений при поставках импортных электронных компонентов на взаимовыгодных условиях!

Наши преимущества:

- Оперативные поставки широкого спектра электронных компонентов отечественного и импортного производства напрямую от производителей и с крупнейших мировых складов;
- Поставка более 17-ти миллионов наименований электронных компонентов;
- Поставка сложных, дефицитных, либо снятых с производства позиций;
- Оперативные сроки поставки под заказ (от 5 рабочих дней);
- Экспресс доставка в любую точку России;
- Техническая поддержка проекта, помощь в подборе аналогов, поставка прототипов;
- Система менеджмента качества сертифицирована по Международному стандарту ISO 9001;
- Лицензия ФСБ на осуществление работ с использованием сведений, составляющих государственную тайну;
- Поставка специализированных компонентов (Xilinx, Altera, Analog Devices, Intersil, Interpoint, Microsemi, Aeroflex, Peregrine, Syfer, Eurofarad, Texas Instrument, Miteq, Cobham, E2V, MA-COM, Hittite, Mini-Circuits, General Dynamics и др.);

Помимо этого, одним из направлений компании «ЭлектроПласт» является направление «Источники питания». Мы предлагаем Вам помощь Конструкторского отдела:

- Подбор оптимального решения, техническое обоснование при выборе компонента;
- Подбор аналогов;
- Консультации по применению компонента;
- Поставка образцов и прототипов;
- Техническая поддержка проекта;
- Защита от снятия компонента с производства.



Как с нами связаться

Телефон: 8 (812) 309 58 32 (многоканальный)

Факс: 8 (812) 320-02-42

Электронная почта: org@eplast1.ru

Адрес: 198099, г. Санкт-Петербург, ул. Калинина, дом 2, корпус 4, литера А.