

DM Series Miniature 2 Pole Power Rocker Switches



Features/Benefits

- 3 AMPS to 10 AMPS
- Quick connect terminals
- Double pole in miniature size
- Recessed bracket available—prevents accidental actuation
- RoHS compliant

Typical Applications

- Computers
- Appliances
- Electric tools

UL 61058-1



Specifications

CONTACT RATING:

DM21, DM22:

GP (general purpose)

3 AMPS 125 VAC 50/60 Hz T85 10,000 cycles

2 AMPS 250 VAC 50/60 Hz T85 10,000 cycles

R (resistive)

3 AMPS 30 VDC T85 10,000 cycles

DM61, DM62:

GP (general purpose)

10 AMPS 125 VAC 50/60 Hz T85 10,000 cycles

5 AMPS 250 VAC 50/60 Hz T85 10,000 cycles

R (resistive)

10 AMPS 30 VDC T85 10,000 cycles

ELECTRICAL LIFE: 10,000 make-and-break cycles at full load.

INSULATION RESISTANCE: $10^9 \Omega$ min.

DIELECTRIC STRENGTH: 1,000 Vrms min. @ sea level.

OPERATING TEMPERATURE: -20°C to +65°C

Materials

HOUSING & ACTUATOR: 6/6 nylon (UL94V-2), black.

MOVABLE CONTACTS: DM2X Models: Copper, silver plated.

DM6X Models: Coin silver, silver plated.

STATIONARY CONTACTS & TERMINALS: Copper or brass, silver plated.

CONTACT SPRING: Music wire or stainless steel.

NOTE: Any models supplied with Q contact material are RoHS compliant.

NOTE: Specifications and materials listed above are for standard switches. For information on specific and custom switches, consult Customer Service Center.

Build-A-Switch

To order, simply select desired option from each category and place in the appropriate box. Available options are shown and described on pages G-66 and G-69. For additional options not shown in catalog, consult Customer Service Center.

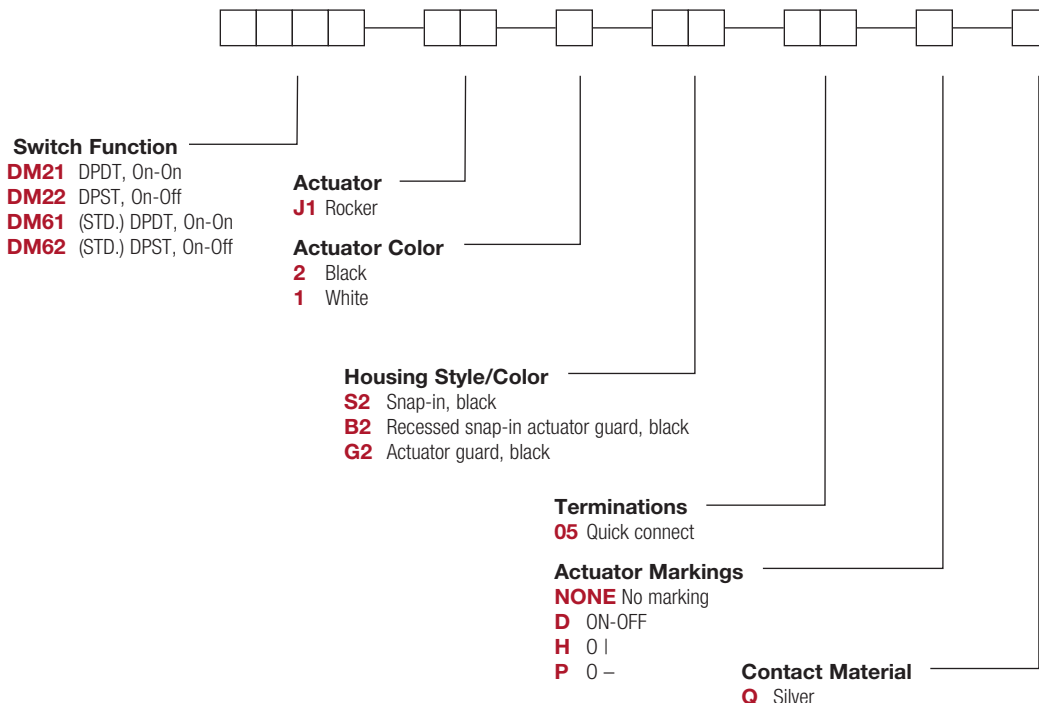

DM Series Miniature 2 Pole Power Rocker Switches

SWITCH FUNCTION



NO. POLES	MODEL NO.	AMP RATING*	SWITCH FUNCTION		CONNECTED TERMINALS		SCHEMATIC
			POS. 1	POS. 2	POS. 1	POS. 2	
DP	DM22	3	ON	OFF	1-1A, 2-2A	OPEN	
	DM62	10	ON	OFF	1-1A, 2-2A	OPEN	
	DM21	3	ON	ON	1-1A, 2-2A	1-1B, 2-2B	
	DM61	10	ON	ON	1-1A, 2-2A	1-1B, 2-2B	

DPDT

PART NUMBER SHOWN: DM21J1XS205Q

NOTES 1. ACTUATOR SHOWN IN POSITION 1-'ON' POSITION

RATINGS: See page G-65 for complete ratings.



UL 61058-1 tested to 30C temperature rise @ 6,000 cycles.

ACTUATOR



J1 ROCKER

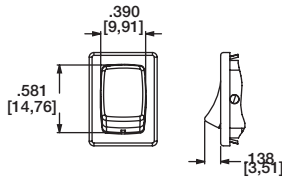

OPTION CODE	ACTUATOR COLOR
2	BLACK
1	WHITE

NOTE: Actuator finish: matte. Other colors available, consult Customer Service Center.

HOUSING STYLE/COLOR



S2 SNAP-IN, BLACK

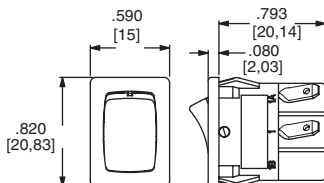

NOTE: Housing finish: matte. Other colors available, consult Customer Service Center.

B2 RECESSED SNAP-IN ACTUATOR GUARD, BLACK

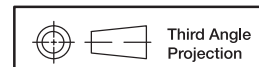
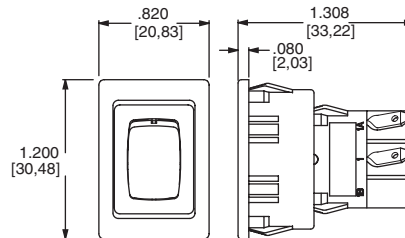

Dimensions are shown: Inches (mm)
Specifications and dimensions subject to change



15 May 20



DM Series Miniature 2 Pole Power Rocker Switches

HOUSING STYLE/COLOR

G2 ACTUATOR GUARD, BLACK

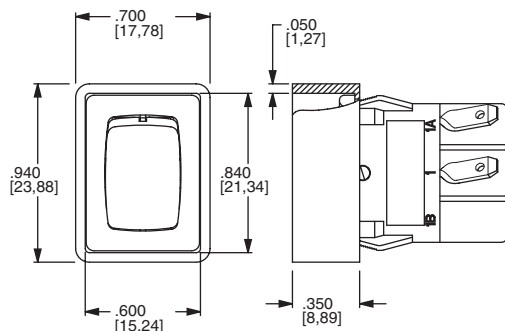

PANEL MOUNTING

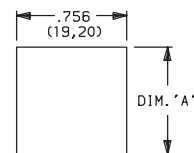
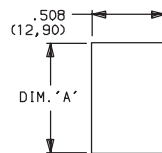

'S2' & 'G2' housing styles

'B2' housing style

NOTE: Blank insert available for SP models only, see page H-76.

PANEL THICKNESS	DIM 'A' 'S2' & 'G2' HOUSING STYLES	DIM 'A' 'G2' OPTION SP MODELS ONLY	DIM 'A' 'B2' HOUSING STYLES
.030-.049 (0,76) (1,24)	.756 (19,20)	0.764 (19,41)	1.068 (27,13)
.049-.079 (1,24) (2,01)	.764 (19,41)	0.780 (19,81)	1.076 (27,33)
.079-.118 (2,01) (3,00)	.780 (19,81)	n/a	1.092 (27,74)

TERMINATIONS

05 QUICK CONNECT

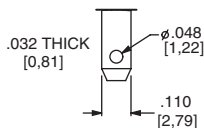

ACTUATOR MARKINGS

NONE NO MARKING

D ON-OFF

H O I

P O -

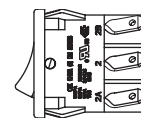
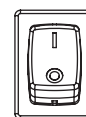

NOTE: Orientation of actuator markings and terminals.

'D' & 'P' marking options: marking color white, standard for all actuator colors except white actuators. Black marking color standard for white actuators. Consult Customer Service Center for other available marking colors.

CONTACT MATERIAL

OPTION CODE	CONTACT AND TERMINAL MATERIAL	RATINGS		
Q	SILVER 1,2	DM21, DM22:	GP (general purpose)	3 AMPS 125 VAC 50/60 Hz T85 10,000 cycles
				2 AMPS 250 VAC 50/60 Hz T85 10,000 cycles
		DM61, DM62:	R (resistive)	3 AMPS 30 VDC T85 10,000 cycles
			GP (general purpose)	10 AMPS 125 VAC 50/60 Hz T85 10,000 cycles
		5 AMPS 250 VAC 50/60 Hz T85 10,000 cycles		
		R (resistive)	10 AMPS 30 VDC T85 10,000 cycles	

* Note: See Technical Data section of this catalog for RoHS compliant and compatible definitions and specifications.

¹ MOVABLE CONTACT: DM2X Models: Copper, silver plated.
DM6X Models: Coin silver, silver plated.

² STATIONARY CONTACTS & TERMINALS: Copper or brass, silver plated.

NOTE: Any models supplied with Q contact material are RoHS compliant.

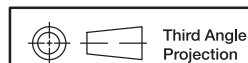

Dimensions are shown: Inches (mm)
Specifications and dimensions subject to change

DM Series Miniature 2 Pole Power Rocker Switches

AVAILABLE HARDWARE

Insert

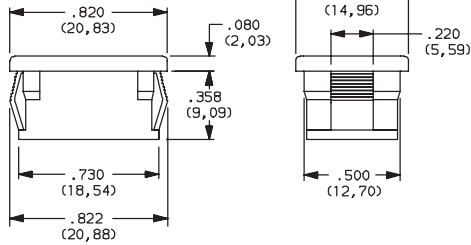

PART NO.
057190200

Material: Nylon 6/6
Finish: Matte

Recessed Actuator Guard



PART NO.
599D02000

Material: 6/6 Nylon
Finish: Matte

Actuator Guard



PART NO.
104C22000

Material: PBT thermoplastic
Finish: Matte

PART NO.
216C00000 IP54 SPLASH PROOF RUBBER BOOT

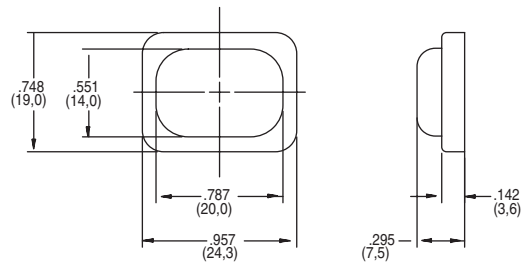

DM Series Miniature Illuminated Power Rocker Switches



Features/Benefits

- 3 AMPS to 10 AMPS
- Illuminated LED
- Positive detent
- RoHS compliant

Typical Applications

- Instrumentation
- Industrial
- Office machines



Specifications

CONTACT RATING:

DM14 and DM24 Models:

GP (general purpose)

3 AMPS @ 125 V AC; 2 AMPS @ 250 V AC.

R (resistive)

3 AMPS 30 VDC 10,000 cycles

DM54 and DM64 Models:

GP (general purpose)

10 AMPS @ 125 V AC; 5 AMPS @ 250 V AC (UL).

R (resistive)

10 AMPS 30 VDC 10,000 cycles

ELECTRICAL LIFE: 10,000 make-and-break cycles at full load.

INSULATION RESISTANCE: $10^9 \Omega$ min.

DIELECTRIC STRENGTH: 1,000 Vrms min. @ sea level.

Materials

HOUSING: 6/6 nylon (UL94V-2), black.

ACTUATOR: 6/6 nylon (UL94V-2), black.

MOVABLE CONTACTS: DM14 and DM24 Models: Copper, silver plated. DM54 and DM64 Models: Coin silver, silver plated.

STATIONARY CONTACTS & TERMINALS: Copper or brass, silver plated.

LED TERMINALS: Brass, unplated.

CONTACT SPRING: Music wire or stainless steel.

OPERATING TEMPERATURE: -20°C to +65°C

NOTE: Any models supplied with Q contact material are RoHS compliant.

NOTE: Specification and materials listed above are for standard switches. For information on specific and custom switches, consult Customer Service Center.

Build-A-Switch

To order, simply select desired option from each category and place in the appropriate box. Available options are shown and described on pages G-70 and G-73. For additional options not shown in catalog, consult Customer Service Center.

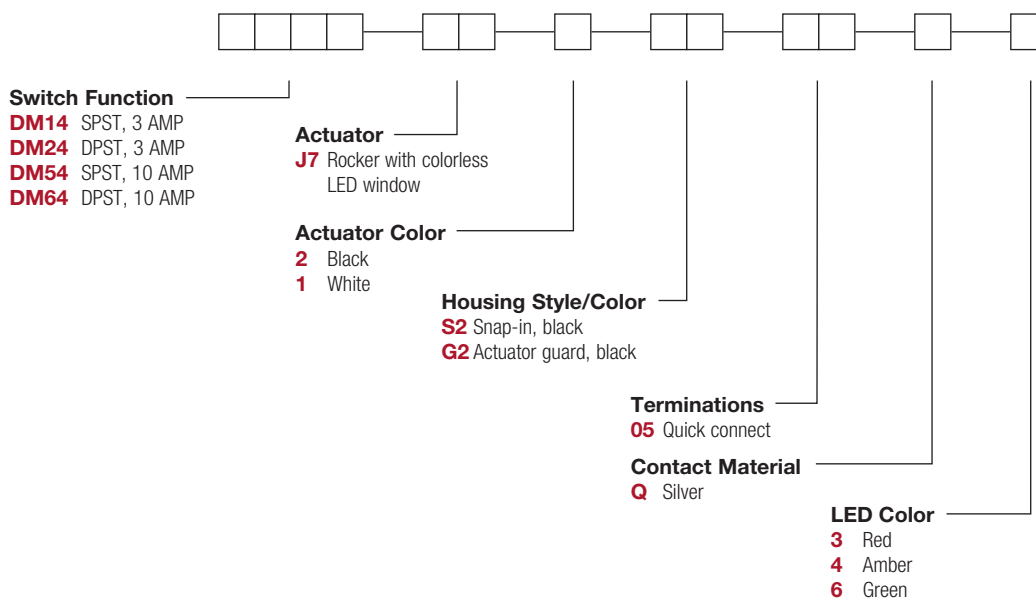

DM Series Miniature Illuminated Power Rocker Switches

SWITCH FUNCTION



NO. POLES	MODEL NO.	AMP RATING*	SWITCH FUNCTION		CONNECTED TERMINALS		SCHEMATIC
			POS. 1	POS. 2	POS. 1	POS. 2	
SP	DM14	3	ON	OFF	1-1A	OPEN	
	DM54	10					
DP	DM24	3	ON	OFF	1-1A, 2-2A	OPEN	
	DM64	10					

DPDT

Actuator shown in pos. 1 - 'ON' position.
SPST MODELS (DM14 & DM54) OMIT TERMINALS 2 & 2A.

Part number shown: DM24J72S205Q3

* RATINGS: see page G-69.



ACTUATOR



J7 ROCKER WITH COLORLESS LED WINDOW

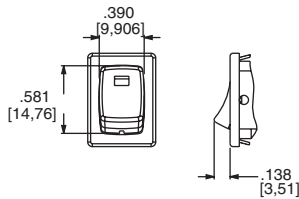

OPTION CODE	ACTUATOR COLOR
2	BLACK
1	WHITE

NOTE: Other colors available, consult Customer Service Center.

HOUSING STYLE/COLOR



S2 SNAP-IN, BLACK

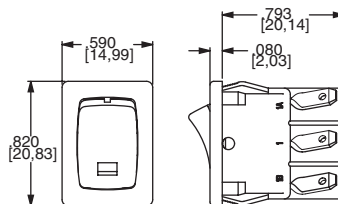

NOTE: Housing finish: matte. Other colors available, consult Customer Service Center.

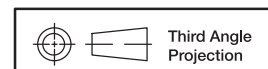

Dimensions are shown: Inches (mm)
Specifications and dimensions subject to change



15 May 20



DM Series Miniature Illuminated Power Rocker Switches

HOUSING STYLE/COLOR

G2 ACTUATOR GUARD, BLACK



PANEL MOUNTING

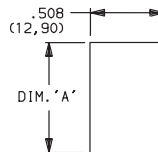

'S2' & 'G2' housing style

NOTE: Blank insert available for SP models only, see page H-80.

PANEL THICKNESS	DIM 'A' 'S2' & 'G2' HOUSING STYLES	DIM 'A' with 'G2' option SP MODELS ONLY
.030-.049 (0,76) (1,24)	0.756 (19,20)	0.764 (19,41)
.049-.079 (1,24) (2,01)	0.764 (19,41)	0.780 (19,81)
.079-.118 (2,01) (3,00)	.780 (19,81)	n/a

TERMINATIONS

05 QUICK CONNECT

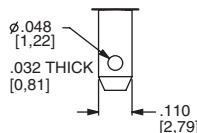

CONTACT MATERIAL

OPTION CODE	CONTACT AND TERMINAL MATERIAL	RATINGS			
Q	SILVER 1,2	POWER	DM14, DM24:	GP (general purpose)	3 AMPS @ 125 V AC; 2 AMPS @ 250 V AC.
				R (resistive)	3 AMPS 30 VDC 10,000 cycles
			DM54, DM64:	GP (general purpose)	10 AMPS @ 125 V AC; 5 AMPS @ 250 V AC.
				R (resistive)	10 AMPS 30 VDC 10,000 cycles

* Note: See Technical Data section of this catalog for RoHS compliant and compatible definitions and specifications.

¹ MOVABLE CONTACTS: DM14 and DM24 models: Copper, silver plated.
DM54 and DM64 models: Coin silver, silver plated.

² STATIONARY CONTACTS & TERMINALS: Copper or brass, silver plated.

NOTE: Any models supplied with Q contact material are RoHS compliant.



LED COLOR

OPTION CODE	LED COLOR	FORWARD V _{FD}	CURRENT I _{LED}	REVERSE V _R	INTENSITY M _{CD}	RECOMMENDED RESISTOR @ VOLTAGE		
						5V	12V	24V
3	Red	2.1	10	4V	1.6 typ.	270	1K	2.2K
4	Amber	2.2	20	4V	2.5 typ.	150	510	1.2K
6	Green	2.1	20	4V	2.0 typ.	150	510	1.2K



Dimensions are shown: Inches (mm)
Specifications and dimensions subject to change

Rocker



15 May 20

DM Series Miniature Illuminated Power Rocker Switches

AVAILABLE HARDWARE

Blank Insert

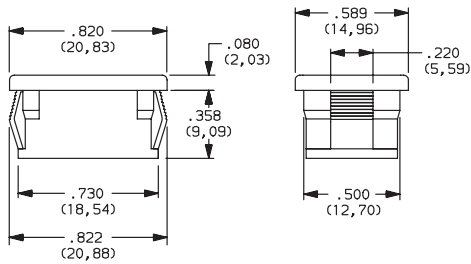

PART NO.
057190200

Material: Zinc nylon 6/6
Finish: Matte

Recessed Bracket

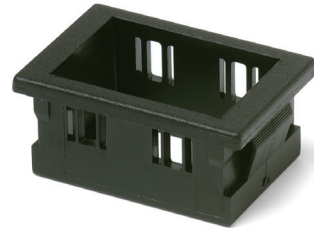

PART NO.
599D02000

Material: 6/6 Nylon
Finish: Matte

Actuator Guard

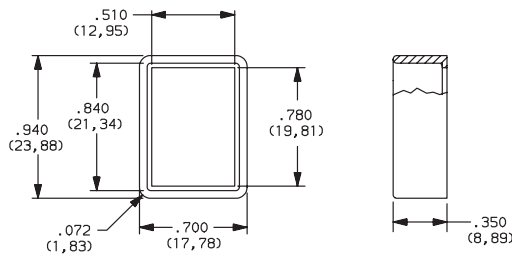

PART NO.
104C22000

Material: PBT thermoplastic
Finish: Matte

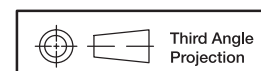

Dimensions are shown: Inches (mm)
Specifications and dimensions subject to change



Компания «ЭлектроПласт» предлагает заключение долгосрочных отношений при поставках импортных электронных компонентов на взаимовыгодных условиях!

Наши преимущества:

- Оперативные поставки широкого спектра электронных компонентов отечественного и импортного производства напрямую от производителей и с крупнейших мировых складов;
- Поставка более 17-ти миллионов наименований электронных компонентов;
- Поставка сложных, дефицитных, либо снятых с производства позиций;
- Оперативные сроки поставки под заказ (от 5 рабочих дней);
- Экспресс доставка в любую точку России;
- Техническая поддержка проекта, помощь в подборе аналогов, поставка прототипов;
- Система менеджмента качества сертифицирована по Международному стандарту ISO 9001;
- Лицензия ФСБ на осуществление работ с использованием сведений, составляющих государственную тайну;
- Поставка специализированных компонентов (Xilinx, Altera, Analog Devices, Intersil, Interpoint, Microsemi, Aeroflex, Peregrine, Syfer, Eurofarad, Texas Instrument, Miteq, Cobham, E2V, MA-COM, Hittite, Mini-Circuits, General Dynamics и др.);

Помимо этого, одним из направлений компании «ЭлектроПласт» является направление «Источники питания». Мы предлагаем Вам помощь Конструкторского отдела:

- Подбор оптимального решения, техническое обоснование при выборе компонента;
- Подбор аналогов;
- Консультации по применению компонента;
- Поставка образцов и прототипов;
- Техническая поддержка проекта;
- Защита от снятия компонента с производства.



Как с нами связаться

Телефон: 8 (812) 309 58 32 (многоканальный)

Факс: 8 (812) 320-02-42

Электронная почта: org@eplast1.ru

Адрес: 198099, г. Санкт-Петербург, ул. Калинина, дом 2, корпус 4, литера А.