

CRYSTAL-MINE

~4.9° spot beam especially designed for mining headlamps. Assembly with holder.

TECHNICAL SPECIFICATIONS:

Dimensions	Ø 50.3 mm
Height	28.7 mm
Fastening	pin, screw
ROHS compliant	yes ⓘ

MATERIAL SPECIFICATIONS:

Component	Type	Material	Colour	Finish
CRYSTAL-MINE	Single lens	PMMA	clear	
CRYSTAL-HLD	Holder	PC	white	



ORDERING INFORMATION:

Component		Qty in box	MOQ	MPQ	Box weight (kg)
FCN13595_CRYSTAL-MINE	Single lens	288	64	32	0.0
» Box size:					

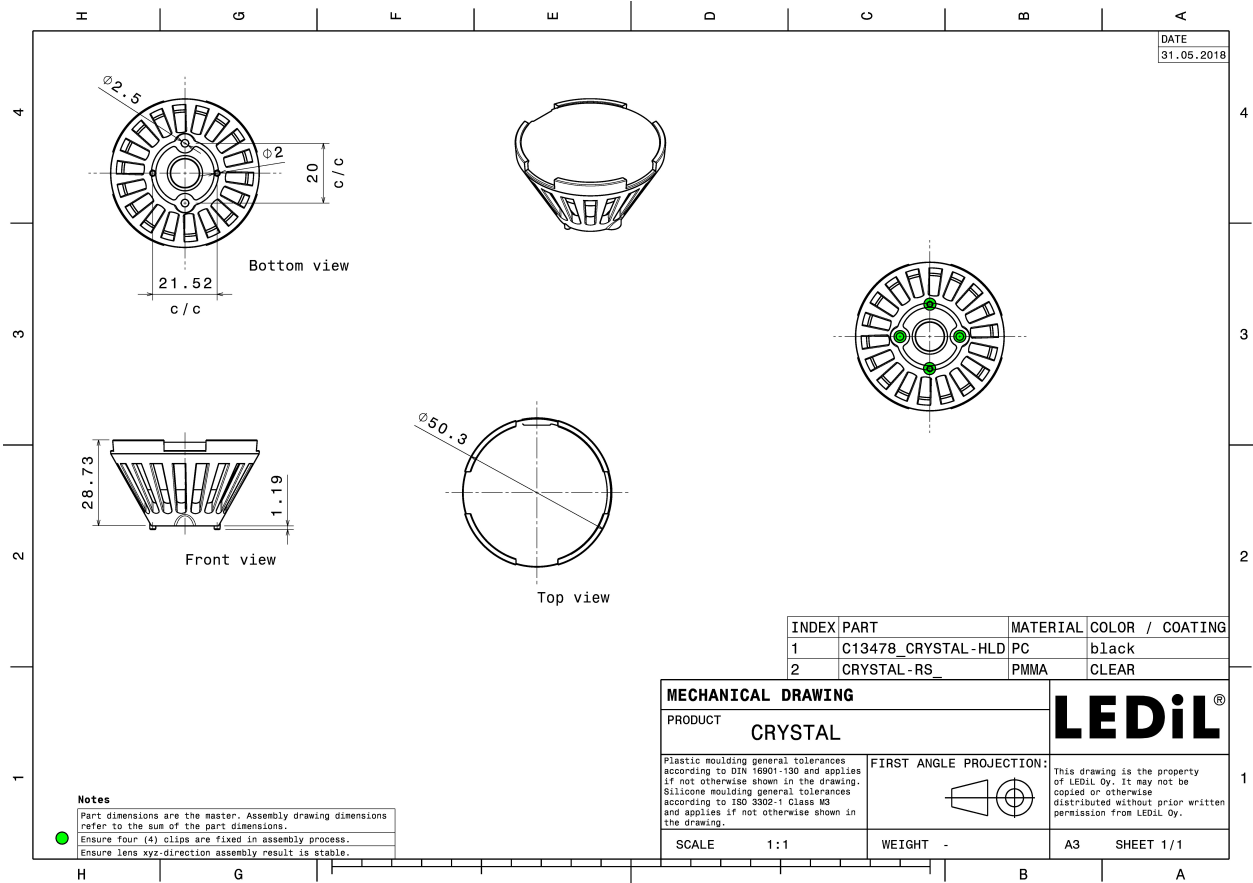

PHOTOMETRIC DATA (MEASURED):

CREE

LED XM-L2
 FWHM 6.9°
 Efficiency 90 %
 Peak intensity 35 cd/Im
 LEDs/each optic 1
 Light colour White
 Required components:

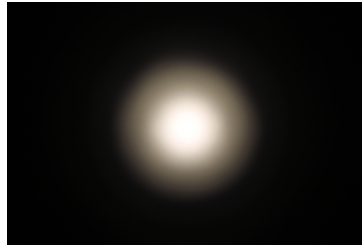

CREE

LED XP-G
 FWHM 4.7°
 Efficiency 90 %
 Peak intensity 66.9 cd/Im
 LEDs/each optic 1
 Light colour White
 Required components:

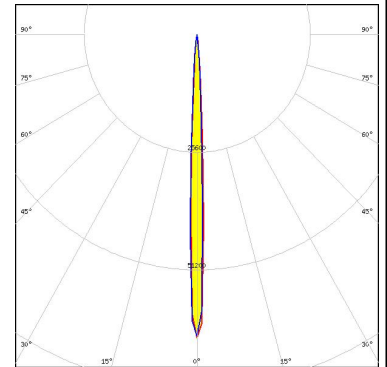

CREE

LED XP-G2
 FWHM 4.6°
 Efficiency 90 %
 Peak intensity 65.2 cd/Im
 LEDs/each optic 1
 Light colour White
 Required components:

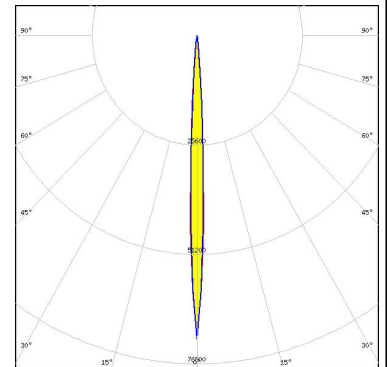

CREE

LED XP-L HD
 FWHM 7.0°
 Efficiency 86 %
 Peak intensity 33 cd/Im
 LEDs/each optic 1
 Light colour White
 Required components:

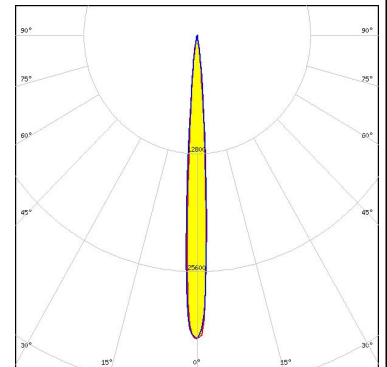

PHOTOMETRIC DATA (MEASURED):



LED XP-L HI
 FWHM 4.5°
 Efficiency 92 %
 Peak intensity 60 cd/Im
 LEDs/each optic 1
 Light colour White
 Required components:

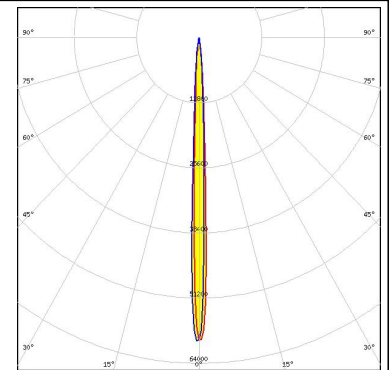
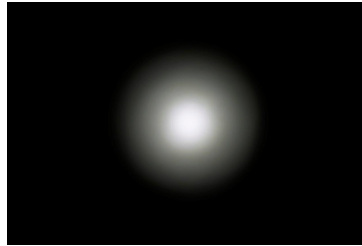

LED LUXEON 5050 Round LES
 FWHM 9.0°
 Efficiency 94 %
 Peak intensity 17.5 cd/Im
 LEDs/each optic 1
 Light colour White
 Required components:

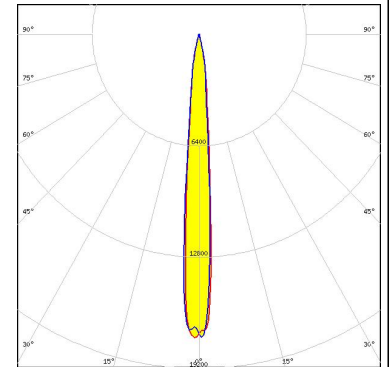
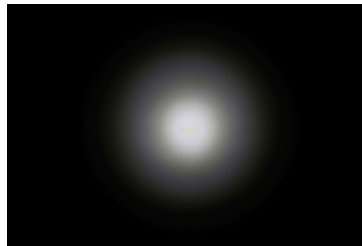

LED LUXEON A
 FWHM 4.9°
 Efficiency 89 %
 Peak intensity 58.2 cd/Im
 LEDs/each optic 1
 Light colour White
 Required components:



LED LUXEON T
 FWHM 4.9°
 Efficiency 89 %
 Peak intensity 55.1 cd/Im
 LEDs/each optic 1
 Light colour White
 Required components:



PHOTOMETRIC DATA (MEASURED):

LUMILEDS

LED LUXEON TX
 FWHM 5.0°
 Efficiency 94 %
 Peak intensity 50.6 cd/Im
 LEDs/each optic 1
 Light colour White
 Required components:

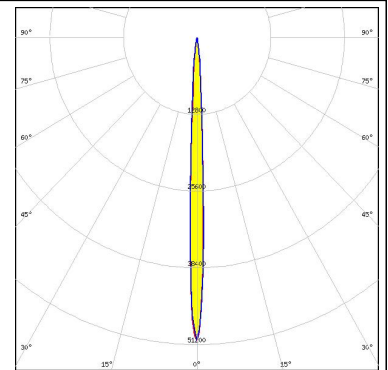
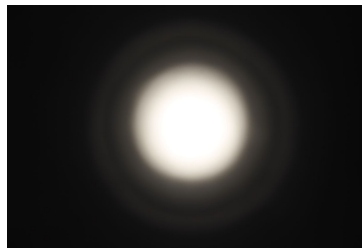

NICHIA

LED NCSxx19B
 FWHM 3.6°
 Efficiency 90 %
 Peak intensity 73.3 cd/Im
 LEDs/each optic 1
 Light colour White
 Required components:

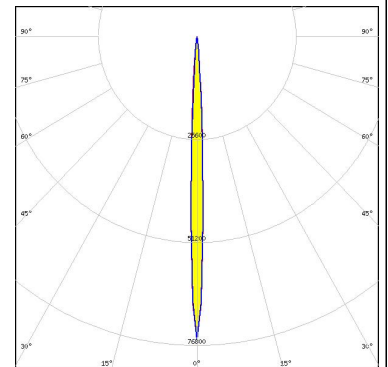
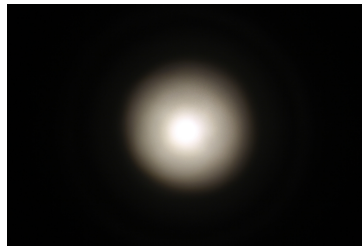

NICHIA

LED NV4x144A
 FWHM 11.0°
 Efficiency 90 %
 Peak intensity 13.4 cd/Im
 LEDs/each optic 1
 Light colour White
 Required components:

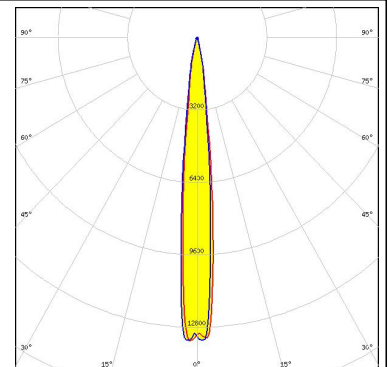

NICHIA

LED NVSxx19B/NVSxx19C
 FWHM 6.0°
 Efficiency 93 %
 Peak intensity 48 cd/Im
 LEDs/each optic 1
 Light colour White
 Required components:

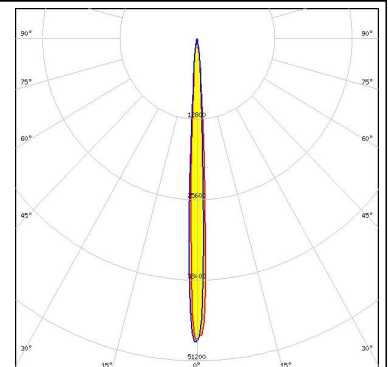
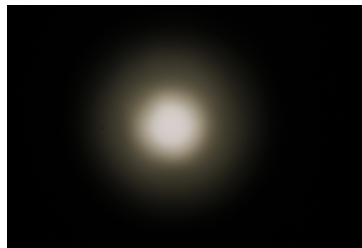

PHOTOMETRIC DATA (MEASURED):



LED NWSx229A
 FWHM 7.0°
 Efficiency 91 %
 Peak intensity 26 cd/lm
 LEDs/each optic 1
 Light colour White
 Required components:

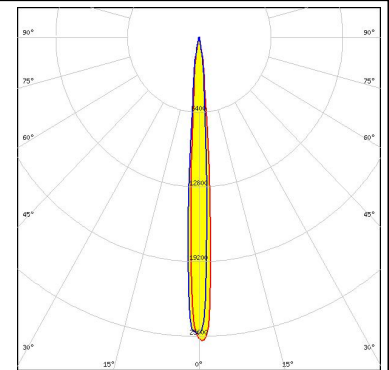

LED LH351B
 FWHM 5.1°
 Efficiency 90 %
 Peak intensity 51.8 cd/lm
 LEDs/each optic 1
 Light colour White
 Required components:



LED LH351Z
 FWHM 4.2°
 Efficiency 90 %
 Peak intensity 71.4 cd/lm
 LEDs/each optic 1
 Light colour White
 Required components:



SEOUL SEMICONDUCTOR

LED nPola
 FWHM 2.0°
 Efficiency 94 %
 Peak intensity 114 cd/lm
 LEDs/each optic 1
 Light colour White
 Required components:

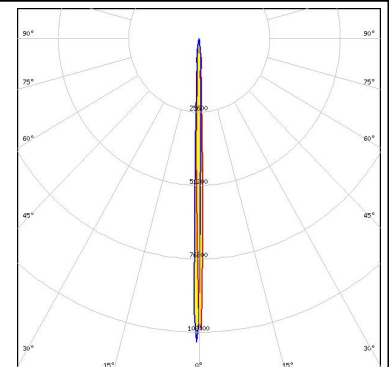

PHOTOMETRIC DATA (MEASURED):

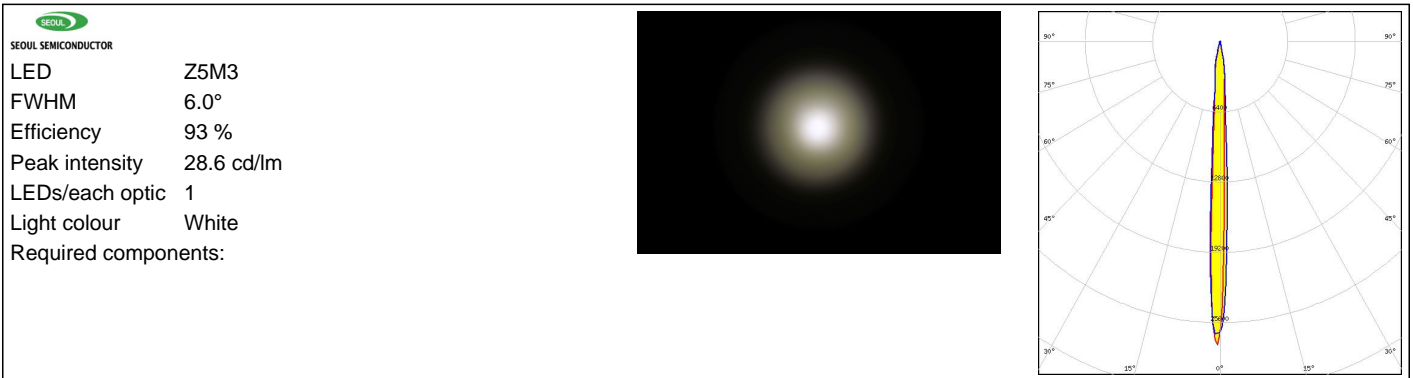

PHOTOMETRIC DATA (SIMULATED):



LED XHP35 HD
 FWHM 7.8°
 Efficiency 94 %
 Peak intensity 28.6 cd/lm
 LEDs/each optic 1
 Light colour White
 Required components:

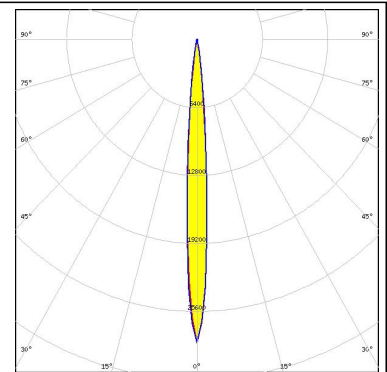

LED XHP35 HI
 FWHM 6.2°
 Efficiency 94 %
 Peak intensity 50.4 cd/lm
 LEDs/each optic 1
 Light colour White
 Required components:

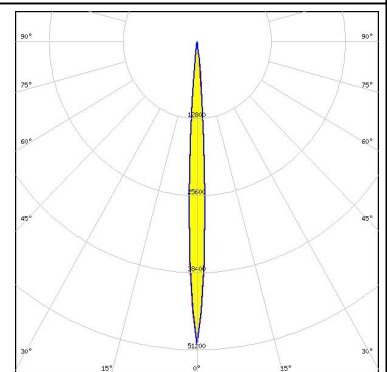

LED OSCONIQ P 3737 (2W version)
 FWHM 5.5°
 Efficiency 94 %
 Peak intensity 59.3 cd/lm
 LEDs/each optic 1
 Light colour White
 Required components:

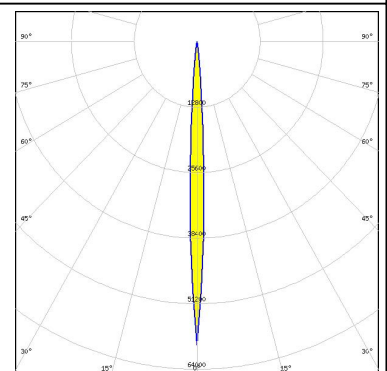



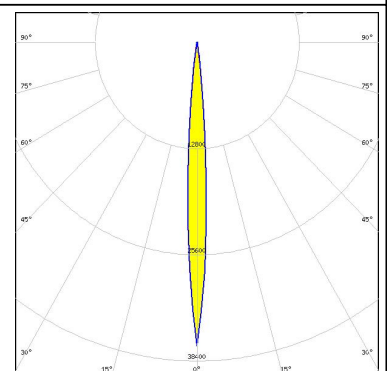

LED OSCONIQ P 3737 (3W version)
 FWHM 5.5°
 Efficiency 94 %
 Peak intensity 59.3 cd/lm
 LEDs/each optic 1
 Light colour White
 Required components:

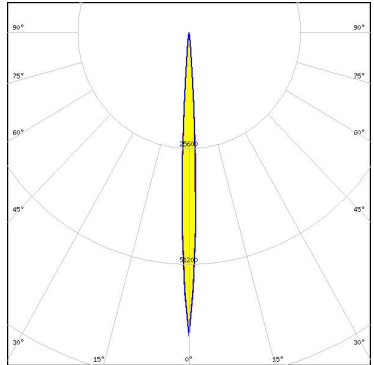
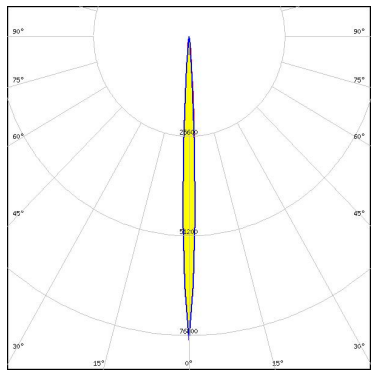
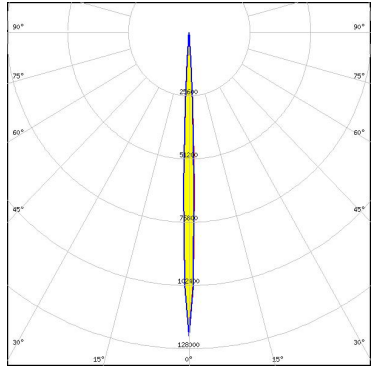
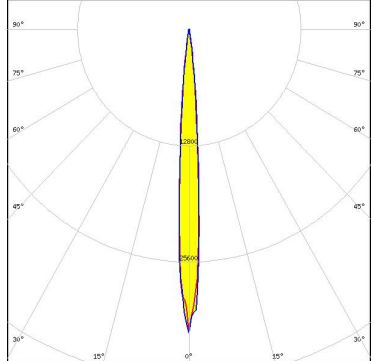

PHOTOMETRIC DATA (SIMULATED):

<p>OSRAM Opto Semiconductors</p> <p>LED OSLON Square CSSRM2/CSSRM3 FWHM 5.4° Efficiency 94 % Peak intensity 67 cd/lm LEDs/each optic 1 Light colour White Required components:</p>		
<p>OSRAM Opto Semiconductors</p> <p>LED OSLON Square Flat FWHM 4.8° Efficiency 94 % Peak intensity 78 cd/lm LEDs/each optic 1 Light colour White Required components:</p>		
<p>OSRAM Opto Semiconductors</p> <p>LED OSTAR Projection Compact (Kx.CSLNM1.xx) FWHM 4.0° Efficiency 94 % Peak intensity 122.8 cd/lm LEDs/each optic 1 Light colour White Required components:</p>		
<p>SAMSUNG</p> <p>LED LH351D FWHM 7.5° Efficiency 97 % Peak intensity 34.2 cd/lm LEDs/each optic 1 Light colour White Required components:</p>		

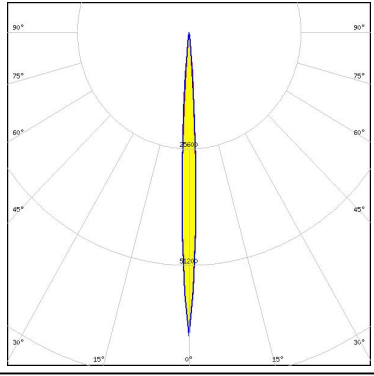
PHOTOMETRIC DATA (SIMULATED):

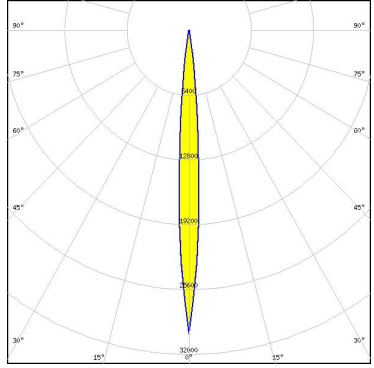
<p> SEOUL SEMICONDUCTOR</p> <p>LED Z5M1/Z5M2 FWHM 5.4° Efficiency 94 % Peak intensity 66.7 cd/lm LEDs/each optic 1 Light colour White Required components:</p>		
<p> SEOUL SEMICONDUCTOR</p> <p>LED Z8Y22P FWHM 7.8° Efficiency 94 % Peak intensity 29.9 cd/lm LEDs/each optic 1 Light colour White Required components:</p>		

GENERAL INFORMATION:

NOTE: The typical beam angle will be changed by different color, chip size and chip position tolerance. The typical total beam angle is the full angle measured where the luminous intensity is half of the peak value.

MATERIALS:

As part of our continuous research and improvement processes, and to ensure the best possible quality and availability of our products, LEDiL reserves the right to change material grades without notice.

PRODUCT DATA USER AGREEMENT AND DISCLAIMER:

The measured data in the provided downloadable LEDiL Product Datasheets and Mechanical 2D-Drawings is rounded and provided as reference for planning. LEDiL Oy's optical specifications have been verified by conducting performance testing of the products in accordance with the company's quality system. The reported data are averaged results of multiple measurements with typical variation. LEDiL Oy reserves the right to without prior notification make changes and improvements to its products.

LEDiL Oy assumes neither warranty, nor guarantee nor any other liability of any kind for the contents and correctness of the provided data. The provided data has been generated with highest diligence but the provided data may in reality not represent the complete possible variation range of all intrinsic parameters. Therefore, in certain cases a deviation from the provided data could occur.

LEDiL Oy reserves the right to undertake technical changes of its products without further notification which could lead to changes in the provided data. LEDiL Oy assumes no liability of any kind for the possible deviation from any provided data or any other damage resulting from the usage of the provided data.

The user agrees to this disclaimer and user agreement with the download or usage of the provided files.

LEDiL Oy

Joensuunkatu 13
FI-24240 SALO
Finland

LEDiL Inc.

228 West Page Street
Suite D
Sycamore IL 60178
USA

Local sales and technical support

[www.ledil.com/
where_to_buy](http://www.ledil.com/where_to_buy)

Shipping locations

Salo, Finland
Hong Kong, China

Distribution Partners

[www.ledil.com/
where_to_buy](http://www.ledil.com/where_to_buy)



Компания «ЭлектроПласт» предлагает заключение долгосрочных отношений при поставках импортных электронных компонентов на взаимовыгодных условиях!

Наши преимущества:

- Оперативные поставки широкого спектра электронных компонентов отечественного и импортного производства напрямую от производителей и с крупнейших мировых складов;
- Поставка более 17-ти миллионов наименований электронных компонентов;
- Поставка сложных, дефицитных, либо снятых с производства позиций;
- Оперативные сроки поставки под заказ (от 5 рабочих дней);
- Экспресс доставка в любую точку России;
- Техническая поддержка проекта, помощь в подборе аналогов, поставка прототипов;
- Система менеджмента качества сертифицирована по Международному стандарту ISO 9001;
- Лицензия ФСБ на осуществление работ с использованием сведений, составляющих государственную тайну;
- Поставка специализированных компонентов (Xilinx, Altera, Analog Devices, Intersil, Interpoint, Microsemi, Aeroflex, Peregrine, Syfer, Eurofarad, Texas Instrument, Miteq, Cobham, E2V, MA-COM, Hittite, Mini-Circuits, General Dynamics и др.);

Помимо этого, одним из направлений компании «ЭлектроПласт» является направление «Источники питания». Мы предлагаем Вам помощь Конструкторского отдела:

- Подбор оптимального решения, техническое обоснование при выборе компонента;
- Подбор аналогов;
- Консультации по применению компонента;
- Поставка образцов и прототипов;
- Техническая поддержка проекта;
- Защита от снятия компонента с производства.



Как с нами связаться

Телефон: 8 (812) 309 58 32 (многоканальный)

Факс: 8 (812) 320-02-42

Электронная почта: org@eplast1.ru

Адрес: 198099, г. Санкт-Петербург, ул. Калинина, дом 2, корпус 4, литера А.