



## Features

- Radial leaded devices
- Fast tripping resettable PTCs
- Binned and sorted narrow resistance ranges available
- RoHS compliant\*
- Agency recognition:   

## Applications

- Customer Premise Equipment (CPE)
- Central Office / Telecom Centers (CO)
- Access equipment

# MF-RX/250 Series - Telecom PTC Resettable Fuses

## Electrical Characteristics

Model	Max. Operating Voltage (Vdc)	Max. Interrupt Ratings		Hold Current	Initial Resistance		One Hour Post-Trip Resistance
		Volts (Vrms)	Amps (A)		Amps at 23 °C	Ohms at 23 °C	
		Max.	Max.	I <sub>H</sub>	Min.	Max.	Max.
MF-RX012/250	60	250	3.0	0.12	4.0	8.0	16.0
MF-RX012/250-A	60	250	3.0	0.12	7.0	9.0	16.0
MF-RX012/250-C	60	250	3.0	0.12	5.5	7.5	14.0
MF-RX012/250-F	60	250	3.0	0.12	6.0	10.5	16.0
MF-RX012/250-1	60	250	3.0	0.12	6.0	9.0	16.0
MF-RX012/250-2	60	250	3.0	0.12	8.0	10.5	16.0
MF-RX012/250-T	60	250	3.0	0.12	7.0	12.0	16.0
MF-RX012/250U	60	250	3.0	0.12	6.0	10.0	16.0
MF-RX014/250	60	250	3.0	0.145	3.0	6.0	14.0
MF-RX014/250-A	60	250	3.0	0.145	3.0	5.5	12.0
MF-RX014/250-B	60	250	3.0	0.145	4.5	6.0	14.0
MF-RX014/250-T	60	250	3.0	0.145	5.4	7.5	14.0
MF-RX014/250U	60	250	3.0	0.145	3.5	6.5	12.0
MF-RX018/250	60	250	10.0	0.18	0.8	2.0	4.0
MF-RX018/250U	60	250	10.0	0.18	0.8	2.0	4.0

\*"U" suffix indicates product without insulation coating.

## Environmental Characteristics

Operating/Storage Temperature.....	-40 °C to +85 °C	
Maximum Device Surface Temperature in Tripped State .....	125 °C	
Passive Aging .....	+85 °C, 1000 hours..... ±15 % typical resistance change	
.....	+60°C, 1000 hours..... ±15 % typical resistance change	
Humidity Aging .....	+85 °C, 85 % R.H. 500 hours..... ±15 % typical resistance change	
Thermal Shock .....	MIL-STD-202F, Method 107G, .....	±10 % typical resistance change
.....	+125 °C to -55 °C, 10 times .....	±15 % typical resistance change
Solvent Resistance.....	MIL-STD-202, Method 215B .....	No change
Lead Solderability .....	ANSI/J-STD-002 .....	>95 % coverage
Flammability .....	IEC 695-2-2 .....	No Flame for 60 secs.
Vibration .....	MIL-STD-883C, Method 2007.1, Condition A .....	±5 % typical resistance change

## Test Procedures And Requirements For Model MF-RX/250 Series

Test	Test Conditions	Accept/Reject Criteria
Visual/Mech .....	Verify dimensions and materials .....	Per MF physical description
Resistance .....	In still air @ 23 °C.....	R <sub>min</sub> ≤ R ≤ R <sub>max</sub>
Time to Trip.....	5 times I <sub>hold</sub> , V <sub>max</sub> , 23 °C .....	T ≤ max. time to trip (seconds)
Hold Current .....	30 min. at I <sub>hold</sub> .....	No trip
Trip Cycle Life .....	V <sub>max</sub> , I <sub>max</sub> , 100 cycles.....	No arcing or burning
Trip Endurance .....	V <sub>max</sub> , 48 hours.....	No arcing or burning
UL File Number .....	E 174545S	
CSA File Number .....	CA 110338	
TÜV File Number .....	R2057213	

\*RoHS Directive 2002/95/EC Jan 27, 2003 including Annex.

Specifications are subject to change without notice.

Customers should verify actual device performance in their specific applications.

## Additional Features

- Ability to withstand AC power cross conditions
- Assists equipment with meeting ITU-T K.20/K.21/K.45
- Assists equipment with meeting Telcordia GR-1089-C Intrabuilding

## MF-RX/250 Series - Telecom PTC Resettable Fuses

**BOURNS®**

### Thermal Derating Chart - $I_{hold}$ (Amps)

Model	Ambient Operating Temperature								
	-40 °C	-20 °C	0 °C	23 °C	40 °C	50 °C	60 °C	70 °C	85 °C
MF-RX012/250	0.186	0.165	0.143	0.120	0.099	0.088	0.077	0.066	0.050
MF-RX014/250	0.225	0.199	0.172	0.145	0.119	0.106	0.093	0.080	0.060
MF-RX018/250	0.269	0.240	0.211	0.180	0.153	0.138	0.123	0.109	0.087

$I_{trip}$  is approximately two times  $I_{hold}$ .

### Product Dimensions

Model	A Max.	B Max.	C Nom.	D Min.	E Max.	Physical Characteristics		
						Lead Dia.	Style	Material
MF-RX012/250	6.5 (0.256)	11.0 (0.433)	5.1 ± 0.7 (0.201 ± 0.028)	4.7 (0.185)	4.6 (0.181)	0.65 (0.026)	1	Sn/Cu
MF-RX012/250U	6.0 (0.236)	10.0 (0.394)	5.1 ± 0.7 (0.201 ± 0.028)	4.7 (0.185)	3.8 (0.150)	0.65 (0.026)	2	Sn/Cu
MF-RX014/250	6.5 (0.256)	11.0 (0.433)	5.1 ± 0.7 (0.201 ± 0.028)	4.7 (0.185)	4.6 (0.181)	0.65 (0.026)	1	Sn/Cu
MF-RX014/250U	6.0 (0.236)	10.0 (0.394)	5.1 ± 0.7 (0.201 ± 0.028)	4.7 (0.185)	3.8 (0.150)	0.65 (0.026)	2	Sn/Cu
MF-RX018/250	11.0 (0.433)	13.6 (0.535)	5.1 ± 0.7 (0.201 ± 0.028)	4.7 (0.185)	4.6 (0.181)	0.65 (0.026)	1	Sn/Cu
MF-RX018/250U	10.4 (0.409)	12.6 (0.496)	5.1 ± 0.7 (0.201 ± 0.028)	4.7 (0.185)	3.8 (0.150)	0.65 (0.026)	2	Sn/Cu

Packaging options: BULK: 500 pcs. per bag. TAPE & REEL: 1500 pcs. per reel (available binned).

DIMENSIONS:  $\frac{MM}{(INCHES)}$

Style 1



Style 2



### Typical Part Marking

Represents total content. Layout may vary.

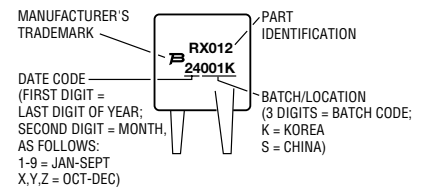

NOTE: UNCOATED PARTS HAVE NO PART MARKING. MARKING IS ON LABEL ONLY.

# MF-RX/250 Series - Telecom PTC Resettable Fuses

**BOURNS®**

## How to Order

**MF - RX 012/250 U - A 5 - 2**



\*Packaged per EIA486-B

## Typical Time to Trip at 23 °C



## Resistance Options

Model	Initial Resistance Values		R1max	Bin
	Ohms @ 23 ° C		Ohms @ 23 ° C	
	Min.	Max.	Max.	
MF-RX012/250	4.0	8.0	16.0	0.5
MF-RX012/250-A05	7.0	9.0	16.0	0.5
MF-RX012/250-C05	5.5	7.5	14.0	0.5
MF-RX012/250-F05	6.0	10.5	16.0	0.5
MF-RX012/250-105	6.0	9.0	16.0	0.5
MF-RX012/250-205	8.0	10.5	16.0	0.5
MF-RX012/250-T05	7.0	12.0	16.0	0.5
MF-RX012/250U	6.0	10.0	16.0	0.5
MF-RX014/250	3.0	6.0	14.0	0.5
MF-RX014/250-A05	3.0	5.5	12.0	0.5
MF-RX014/250-B05	4.5	6.0	14.0	0.5
MF-RX014/250U	3.5	6.5	12.0	0.5

MF-RX/250, REV. J, 05/11

Specifications are subject to change without notice.  
Customers should verify actual device performance in their specific applications.

# MF-R, MF-R/90, MF-R/600, MF-RX, MF-RX/72 & MF-RX/250 Series Tape and Reel Specifications

**BOURNS®**

Devices taped using EIA468-B/IEC286-2 standards. See table below and Figures 1 and 2 for details.

Dimension Description	IEC Mark	EIA Mark	Dimensions	
			Dimensions	Tolerance
Carrier tape width	$W$	$W$	$\frac{18}{(.709)}$	$\frac{-0.5/+1.0}{(-0.02/+0.039)}$
Hold down tape width	$W_0$	$W_4$	$\frac{11}{(.433)}$	min.
Hold down tape			No protrusion	
Top distance between tape edges	$W_2$	$W_6$	$\frac{3}{(.118)}$	max.
Sprocket hole position	$W_1$	$W_5$	$\frac{9}{(.354)}$	$\frac{-0.5/+0.75}{(-0.02/+0.03)}$
Sprocket hole diameter	$D_0$	$D_0$	$\frac{4}{(.157)}$	$\frac{\pm 0.2}{(\pm .0078)}$
Abscissa to plane (straight lead)	$H$	$H$	$\frac{18.5}{(.728)}$	$\frac{\pm 3.0}{(\pm .118)}$
Abscissa to plane (kinked lead)	$H_0$	$H_0$	$\frac{16}{(.63)}$	$\frac{\pm 0.5}{(\pm .02)}$
Abscissa to top (straight lead)	$H_1$	$H_1$	$\frac{38.0}{(1.496)}$	max.
Abscissa to top (kinked lead)	$H_1$	$H_1$	$\frac{32.2}{(1.268)}$	max.
Overall width w/lead protrusion (straight lead)		$C_1$	$\frac{55.0}{(2.165)}$	max.
Overall width w/lead protrusion (kinked lead)		$C_1$	$\frac{43.2}{(1.7)}$	max.
Overall width w/o lead protrusion (straight lead)		$C_2$	$\frac{54.0}{(2.126)}$	max.
Overall width w/o lead protrusion (kinked lead)		$C_2$	$\frac{42.5}{(1.673)}$	max.
Lead protrusion	$l_1$	$L_1$	$\frac{1.0}{(.039)}$	max.
Protrusion of cutout	$L$	$L$	$\frac{11}{(.433)}$	max.
Protrusion beyond hold-down tape	$l_2$	$l_2$	Not specified	
Sprocket hole pitch	$P_0$	$P_0$	$\frac{12.7}{(0.5)}$	$\frac{\pm 0.3}{(\pm .012)}$
Pitch tolerance			20 consecutive	$\frac{\pm 1}{(\pm .039)}$
Device pitch: MF-R005–MF-R160, MF-R/90, MF-RX110/72–MF-RX185/72			$\frac{12.7}{(0.5)}$	$\frac{\pm 0.3}{(\pm .012)}$
Device pitch: MF-R185–MF-R400, MF-RX110–MF-RX375 MF-R/600, MF-RX250/72–MF-RX375/72			$\frac{25.4}{(1.0)}$	$\frac{\pm 0.6}{(\pm .024)}$
Tape thickness	$t$	$t$	$\frac{0.9}{(.035)}$	max.
Tape thickness with splice: MF-R010–MF-R160, MF-RX110/72–MF-RX185/72		$t_1$	$\frac{1.5}{(.059)}$	max.
Tape thickness with splice: MF-R250–MF-R1100, MF-RX110–MF-RX375, MF-R/90, MF-RX250/72–MF-RX375/72		$t_1$	$\frac{2.3}{(.091)}$	max.
Splice sprocket hole alignment			0	$\frac{\pm 0.3}{(\pm .012)}$
Body lateral deviation	$\Delta_h$	$\Delta_h$	0	$\frac{\pm 1.0}{(\pm .039)}$
Body tape plane deviation	$\Delta_p$	$\Delta_p$	0	$\frac{\pm 1.3}{(\pm .051)}$

Specifications are subject to change without notice.  
Customers should verify actual device performance in their specific applications.

DIMENSIONS:  $\frac{\text{MM}}{\text{(INCHES)}}$

# MF-R, MF-R/90, MF-R/600, MF-RX, MF-RX/72 & MF-RX/250 Series Tape and Reel Specifications



Dimension Description	IEC Mark	EIA Mark	Dimensions			
			Dimensions	Tolerance		
Lead spacing: MF-R, MF-R/90, MF-R/600, MF-RX, MF-RX/72	<i>F</i>	<i>F</i>	5.08 (0.2)	$\pm 0.2$ ( $\pm 0.008$ )		
Lead spacing: MF-RX/250	<i>F</i>	<i>F</i>	5.08 (0.2)	$-0.5/+0.6$ ( $-0.020/+0.024$ )		
Reel width	<i>w</i>	<i>W<sub>2</sub></i>	56.0 (2.205)	max.		
Reel diameter	<i>d</i>	<i>a</i>	370.0 (14.57)	max.		
Space between flanges less device	<i>W<sub>1</sub></i>	<i>h</i>	4.75 (.187)	$\pm 3.25$ ( $\pm .128$ )		
Arbor hole diameter	<i>f</i>	<i>c</i>	26.0 (1.024)	$\pm 12.0$ ( $\pm .472$ )		
Core diameter: MF-R, MF-RX, MF-R/90	<i>h</i>	<i>n</i>	80 (3.15)	max.		
Core diameter: MF-RX/250, MF-R/600	<i>h</i>	<i>n</i>	91 (3.58)	max.		
Box: MF-R, MF-RX, MF-R/90			56 (2.2)	372 (14.6)	372 (14.6)	max.
Box: MF-RX/250			67 (2.64)	372 (14.6)	362 (14.25)	max.
Box: MF-R/600			64 (2.52)	372 (14.6)	362 (14.25)	max.
Consecutive missing places: MF-R, MF-RX, MF-R/90			3			max.
Consecutive missing places: MF-RX/250, MF-R/600			none			
Empty places per reel: MF-R, MF-RX, MF-R/90						Not specified
Empty places per reel: MF-RX/250, MF-R/600						0.1 %

**Taped Component Dimensions - Figure 1**

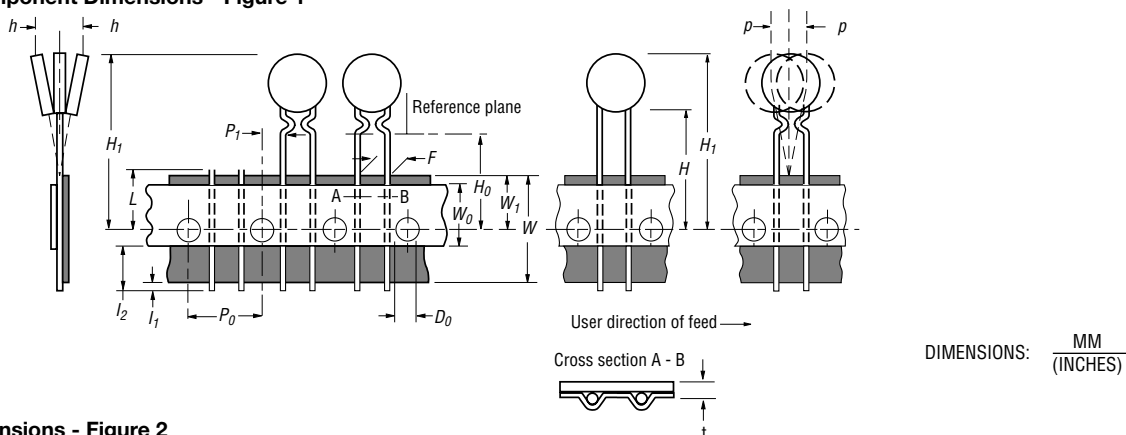

**Reel Dimensions - Figure 2**

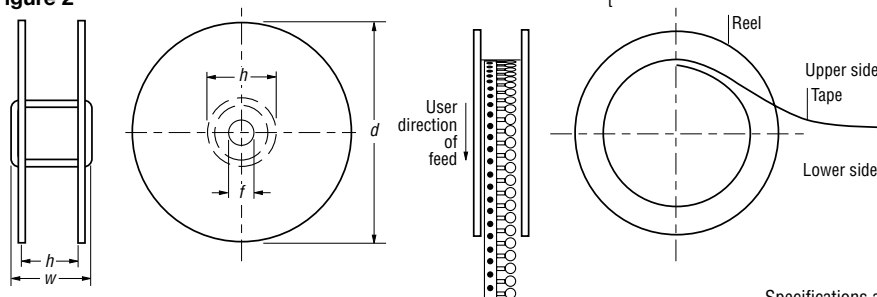

Specifications are subject to change without notice.  
Customers should verify actual device performance in their specific applications.



Компания «ЭлектроПласт» предлагает заключение долгосрочных отношений при поставках импортных электронных компонентов на взаимовыгодных условиях!

Наши преимущества:

- Оперативные поставки широкого спектра электронных компонентов отечественного и импортного производства напрямую от производителей и с крупнейших мировых складов;
- Поставка более 17-ти миллионов наименований электронных компонентов;
- Поставка сложных, дефицитных, либо снятых с производства позиций;
- Оперативные сроки поставки под заказ (от 5 рабочих дней);
- Экспресс доставка в любую точку России;
- Техническая поддержка проекта, помощь в подборе аналогов, поставка прототипов;
- Система менеджмента качества сертифицирована по Международному стандарту ISO 9001;
- Лицензия ФСБ на осуществление работ с использованием сведений, составляющих государственную тайну;
- Поставка специализированных компонентов (Xilinx, Altera, Analog Devices, Intersil, Interpoint, Microsemi, Aeroflex, Peregrine, Syfer, Eurofarad, Texas Instrument, Miteq, Cobham, E2V, MA-COM, Hittite, Mini-Circuits, General Dynamics и др.);

Помимо этого, одним из направлений компании «ЭлектроПласт» является направление «Источники питания». Мы предлагаем Вам помощь Конструкторского отдела:

- Подбор оптимального решения, техническое обоснование при выборе компонента;
- Подбор аналогов;
- Консультации по применению компонента;
- Поставка образцов и прототипов;
- Техническая поддержка проекта;
- Защита от снятия компонента с производства.



#### Как с нами связаться

**Телефон:** 8 (812) 309 58 32 (многоканальный)

**Факс:** 8 (812) 320-02-42

**Электронная почта:** [org@eplast1.ru](mailto:org@eplast1.ru)

**Адрес:** 198099, г. Санкт-Петербург, ул. Калинина, дом 2, корпус 4, литера А.