

EC103xx & SxSx Series

RoHS

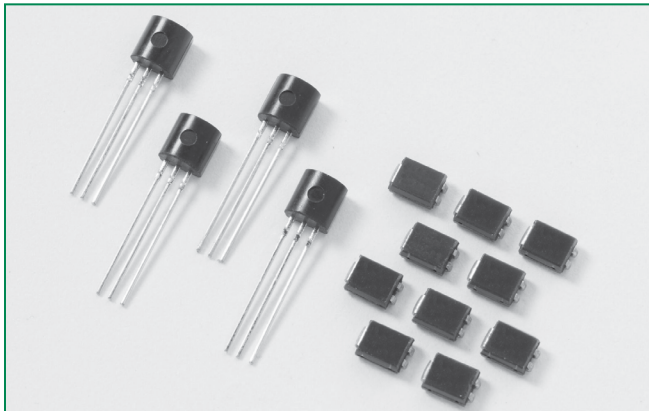

Description

Excellent unidirectional switches for phase control applications such as heating and motor speed controls.

Sensitive gate SCRs are easily triggered with microAmps of current as furnished by sense coils, proximity switches, and microprocessors.

Features & Benefits

- RoHS compliant
- Glass – passivated junctions
- Voltage capability up to 600 V
- Surge capability up to 20 A

Main Features

| Symbol | Value | Unit |
|-------------------|------------|---------|
| $I_{T(RMS)}$ | 0.8 | A |
| V_{DRM}/V_{RRM} | 400 to 600 | V |
| I_{GT} | 12 to 500 | μA |

Schematic Symbol

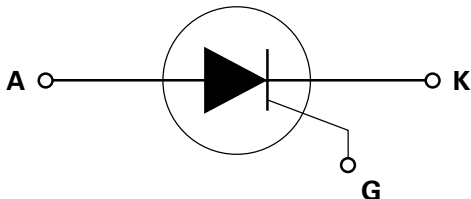

Applications

Typical applications are capacitive discharge systems for strobe lights and gas engine ignition. Also controls for power tools, home/brown goods and white goods appliances.

Additional Information



Datasheet



Resources



Samples

Absolute Maximum Ratings – Sensitive SCRs

| Symbol | Parameter | Test Conditions | Value | Unit |
|--------------|---|--|------------|------------|
| $I_{T(RMS)}$ | RMS on-state current | $T_c = 75^\circ C$ | 0.8 | A |
| $I_{T(AV)}$ | Average on-state current | $T_c = 75^\circ C$ | 0.51 | A |
| I_{TSM} | Peak non-repetitive surge current | single half cycle; $f = 50\text{Hz}$; $T_J(\text{initial}) = 25^\circ C$ | 16 | A |
| | | single half cycle; $f = 60\text{Hz}$; $T_J(\text{initial}) = 25^\circ C$ | 20 | |
| I^2t | I^2t Value for fusing | $t_p = 8.3 \text{ ms}$ | 1.6 | A^2s |
| di/dt | Critical rate of rise of on-state current | $f = 60 \text{ Hz}$; $T_J = 110^\circ C$ | 50 | $A/\mu s$ |
| I_{GM} | Peak gate current | $T_J = 110^\circ C$ | 1 | A |
| $P_{G(AV)}$ | Average gate power dissipation | $T_J = 110^\circ C$ | 0.1 | W |
| T_{stg} | Storage temperature range | | -40 to 150 | $^\circ C$ |
| T_J | Operating junction temperature range | | -40 to 110 | $^\circ C$ |

Electrical Characteristics (T_J = 25°C, unless otherwise specified)

| Symbol | Test Conditions | | | Value | | | | Unit |
|-----------------|---|------|------|-----------------|-----------------|---------------------------|-----------------|------|
| | | | | SxS1 EC103X1 | SxS2 EC103X2 | SxS / 2N6565 EC103X | SxS3 EC103X3 | |
| I _{GT} | V _D = 6V; R _L = 100 Ω | | MAX. | 12 | 50 | 200 | 500 | μA |
| V _{GT} | | | MAX. | 0.8 | | | | V |
| dv/dt | V _D = V _{DRM} ; R _{GK} = 1kΩ | 400V | MIN. | 20 | 25 | 30 | 40 | V/μs |
| | | 600V | | 10 | 10 | 15 | 20 | |
| V _{GD} | V _D = V _{DRM} ; R _L = 3.3 kΩ; T _J = 110°C | | MIN. | 0.2 | 0.25 | | | V |
| I _H | I _T = 20mA (initial), R _{GK} = 1kΩ | | MAX. | 5 | | | 8 | mA |
| t _q | (1) | | MAX. | 60 | | 50 | 45 | μs |
| t _{gt} | I _G = 2 × I _{GT} ; PW = 15μs; I _T = 1.6A | | TYP. | 2 | 5 | 20 | 30 | μs |

(1) I_T=1A; t_p=50μs; dv/dt=5V/μs; di/dt=-5A/μs

Static Characteristics

| Symbol | Test Conditions | | Value | Unit | |
|-------------------------------------|--|------------------------|-------|------|----|
| V _{TM} | I _T = 1.2A; t _p = 380 μs | | MAX. | 1.7 | V |
| I _{DRM} / I _{RRM} | V _{DRM} = V _{RRM} R _{GK} = 1kΩ | T _J = 25°C | MAX. | 1 | μA |
| | | T _J = 100°C | | 50 | |
| | | T _J = 110°C | | 100 | |

Thermal Resistances

| Symbol | Parameter | Value | Unit |
|---------------------|-----------------------|----------------|------|
| R _{θ(J-C)} | Junction to case (AC) | EC103xy/2N6565 | 75 |
| | | SxSy | 60* |
| R _{θ(J-A)} | Junction to ambient | EC103xy/2N6565 | 160 |

Notes: x = voltage, y = sensitivity

* = Mounted on 1 cm² copper (two-ounce) foil surface

Figure 1: Normalized DC Gate Trigger Current vs. Junction Temperature



Figure 2: Normalized DC Gate Trigger Voltage vs. Junction Temperature

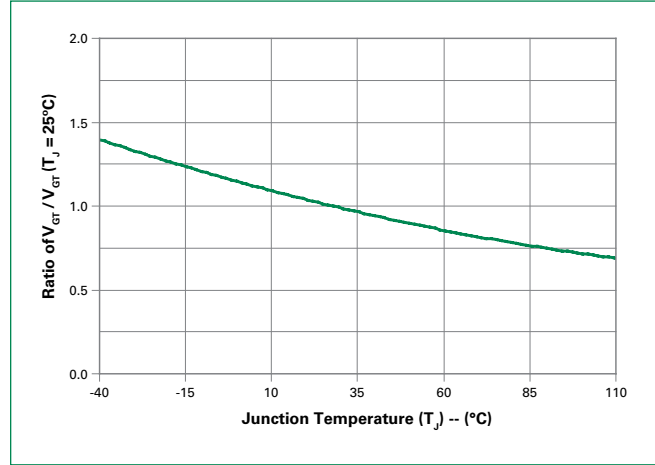

Figure 3: Normalized DC Holding Current vs. Junction Temperature



Figure 4: On-State Current vs. On-State Voltage (Typical)

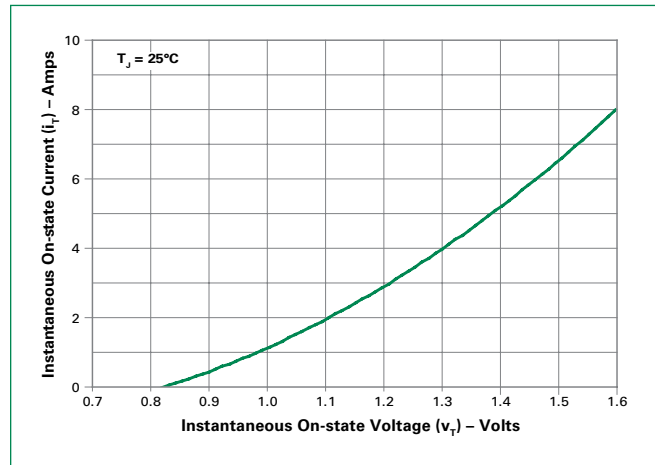

Figure 5: Power Dissipation (Typical) vs. RMS On-State Current



Figure 6: Maximum Allowable Case Temperature vs. RMS On-State Current

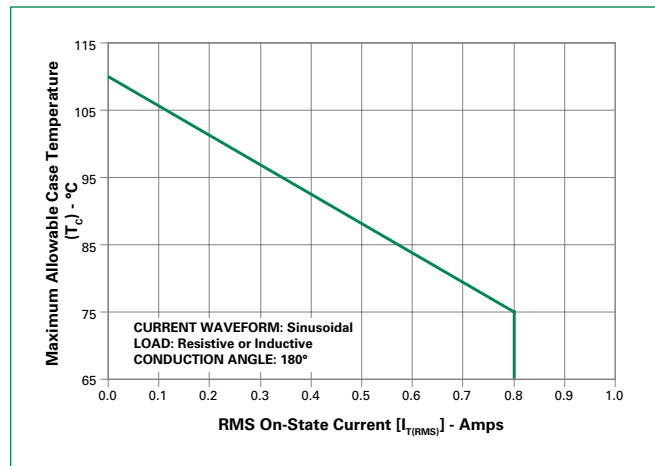

Figure 7: Maximum Allowable Case Temperature vs. Average On-State Current



Figure 8: Maximum Allowable Ambient Temperature vs. RMS On-State Current



Figure 9: Maximum Allowable Ambient Temperature vs. Average On-State Current



Figure 10: Peak Capacitor Discharge Current



Figure 11: Peak Repetitive Sinusoidal Pulse Current



Figure 12: Surge Peak On-State Current vs. Number of Cycles

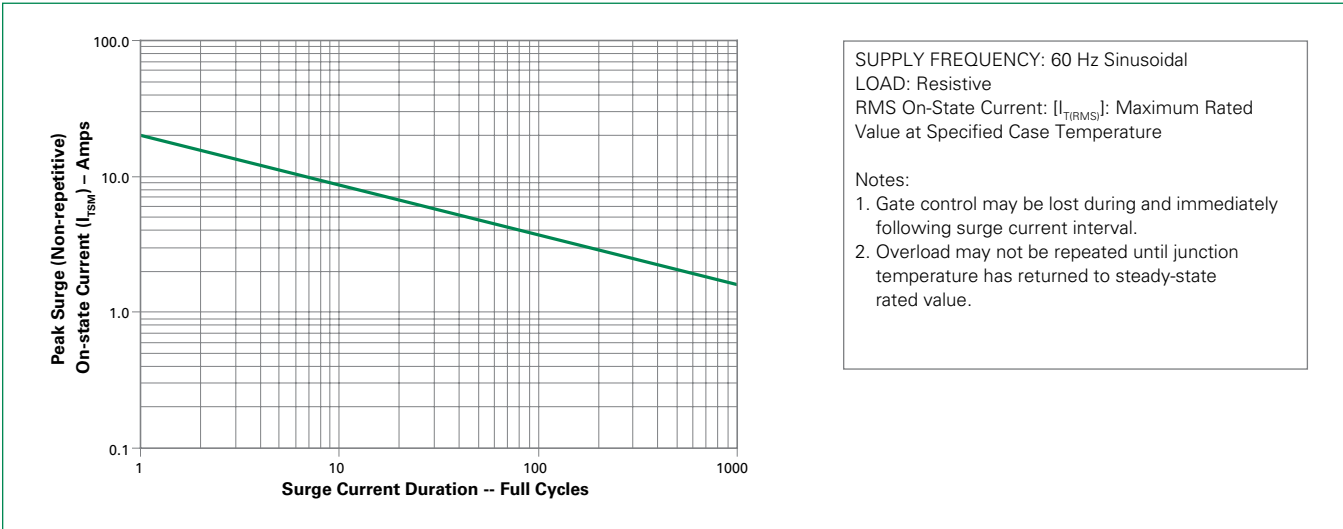
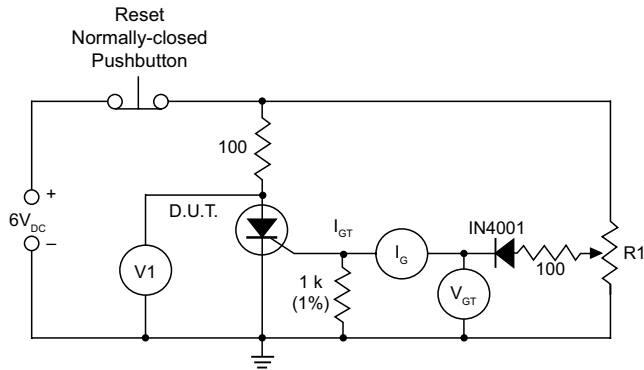

Figure 13: Simple Test Circuit for Gate Trigger Voltage and Current



Note: V1 — 0 V to 10 V dc meter
V_{GT} — 0 V to 1 V dc meter
I_G — 0 mA to 1 mA dc milliammeter
R1 — 1 k potentiometer

To measure gate trigger voltage and current, raise gate voltage (V_{GT}) until meter reading V1 drops from 6 V to 1 V. Gate trigger voltage is the reading on V_{GT} just prior to V1 dropping. Gate trigger current I_{GT} can be computed from the relationship

$$I_{GT} = I_G \cdot \frac{V_{GT}}{1000} \text{ Amps}$$

where I_G is reading (in amperes) on meter just prior to V1 dropping

Note: I_{GT} may turn out to be a negative quantity (trigger current flows out from gate lead). If negative current occurs, I_{GT} value is not a valid reading. Remove 1 k resistor and use I_G as the more correct I_{GT} value. This will occur on 12 μA gate products.

Soldering Parameters

| | | |
|--|------------------------------------|-------------------------|
| Reflow Condition | | Pb – Free assembly |
| Pre Heat | - Temperature Min ($T_{s(min)}$) | 150°C |
| | - Temperature Max ($T_{s(max)}$) | 200°C |
| | - Time (min to max) (t_s) | 60 – 180 secs |
| Average ramp up rate (Liquidus Temp) (T_L) to peak | | 5°C/second max |
| $T_{s(max)}$ to T_L - Ramp-up Rate | | 5°C/second max |
| Reflow | - Temperature (T_L) (Liquidus) | 217°C |
| | - Temperature (t_l) | 60 – 150 seconds |
| Peak Temperature (T_p) | | 260 ^{+0/-5} °C |
| Time within 5°C of actual peak Temperature (t_p) | | 20 – 40 seconds |
| Ramp-down Rate | | 5°C/second max |
| Time 25°C to peak Temperature (T_p) | | 8 minutes Max. |
| Do not exceed | | 280°C |



Physical Specifications

| | |
|------------------------|---|
| Terminal Finish | 100% Matte Tin-plated/Pb-free Solder Dipped |
| Body Material | UL recognized epoxy meeting flammability classification 94V-0 |
| Lead Material | Copper Alloy |

Design Considerations

Careful selection of the correct device for the application's operating parameters and environment will go a long way toward extending the operating life of the Thyristor. Good design practice should limit the maximum continuous current through the main terminals to 75% of the device rating. Other ways to ensure long life for a power discrete semiconductor are proper heat sinking and selection of voltage ratings for worst case conditions. Overheating, overvoltage (including dv/dt), and surge currents are the main killers of semiconductors. Correct mounting, soldering, and forming of the leads also help protect against component damage.

Environmental Specifications

| Test | Specifications and Conditions |
|----------------------------------|---|
| AC Blocking | MIL-STD-750, M-1040, Cond A Applied Peak AC voltage @ 110°C for 1008 hours |
| Temperature Cycling | MIL-STD-750, M-1051, 100 cycles; -40°C to +150°C; 15-min dwell-time |
| Temperature/Humidity | EIA / JEDEC, JESD22-A101 1008 hours; 320V - DC: 85°C; 85% rel humidity |
| High Temp Storage | MIL-STD-750, M-1031, 1008 hours; 150°C |
| Low-Temp Storage | 1008 hours; -40°C |
| Thermal Shock | MIL-STD-750, M-1056 10 cycles; 0°C to 100°C; 5-min dwell-time at each temperature; 10 sec (max) transfer time between temperature |
| Autoclave | EIA / JEDEC, JESD22-A102 168 hours (121°C at 2 ATMs) and 100% R/H |
| Resistance to Solder Heat | MIL-STD-750 Method 2031 |
| Solderability | ANSI/J-STD-002, category 3, Test A |
| Lead Bend | MIL-STD-750, M-2036 Cond E |

Dimensions – TO-92 (E Package)



| Dimension | Inches | | Millimeters | |
|-----------|--------|-------|-------------|------|
| | Min | Max | Min | Max |
| A | 0.176 | 0.196 | 4.47 | 4.98 |
| B | 0.500 | - | 12.70 | - |
| D | 0.095 | 0.105 | 2.41 | 2.67 |
| E | 0.150 | - | 3.81 | - |
| F | 0.046 | 0.054 | 1.16 | 1.37 |
| G | 0.135 | 0.145 | 3.43 | 3.68 |
| H | 0.088 | 0.096 | 2.23 | 2.44 |
| J | 0.176 | 0.186 | 4.47 | 4.73 |
| K | 0.088 | 0.096 | 2.23 | 2.44 |
| L | 0.013 | 0.019 | 0.33 | 0.48 |
| M | 0.013 | 0.017 | 0.33 | 0.43 |

All leads insulated from case. Case is electrically nonconductive.

Dimensions – Compak (C Package)



| Dimension | Inches | | Millimeters | |
|-----------|--------|-------|-------------|------|
| | Min | Max | Min | Max |
| A | 0.130 | 0.156 | 3.30 | 3.95 |
| B | 0.201 | 0.220 | 5.10 | 5.60 |
| C | 0.077 | 0.087 | 1.95 | 2.20 |
| D | 0.159 | 0.181 | 4.05 | 4.60 |
| E | 0.030 | 0.063 | 0.75 | 1.60 |
| F | 0.075 | 0.096 | 1.90 | 2.45 |
| G | 0.002 | 0.008 | 0.05 | 0.20 |
| H | 0.077 | 0.104 | 1.95 | 2.65 |
| J | 0.043 | 0.053 | 1.09 | 1.35 |
| K | 0.006 | 0.016 | 0.15 | 0.41 |
| L | 0.030 | 0.055 | 0.76 | 1.40 |
| M | 0.022 | 0.028 | 0.56 | 0.71 |
| N | 0.027 | 0.033 | 0.69 | 0.84 |
| P | 0.052 | 0.058 | 1.32 | 1.47 |

Product Selector

| Part Number | Voltage | | | | Gate Sensitivity | Type | Package |
|-------------|------------|------|------|-------|------------------|---------------|---------|
| | 400V | 600V | 800V | 1000V | | | |
| EC103 x 1 | X | X | | | 12μA | Sensitive SCR | TO-92 |
| EC103 x 2 | X | X | | | 50μA | Sensitive SCR | TO-92 |
| EC103 x | X / 2N6565 | X | | | 200μA | Sensitive SCR | TO-92 |
| EC103 x 3 | X | X | | | 500μA | Sensitive SCR | TO-92 |
| S x S1 | X | X | | | 12μA | Sensitive SCR | Compak |
| S x S2 | X | X | | | 50μA | Sensitive SCR | Compak |
| S x S | X | X | | | 200μA | Sensitive SCR | Compak |
| S x S3 | X | X | | | 500μA | Sensitive SCR | Compak |

Note: x = Voltage

Packing Options

| Part Number | Marking | Weight | Packing Mode | Base Quantity |
|------------------|------------------|--------|------------------|---------------|
| EC103xy / 2N6565 | EC103xy / 2N6565 | 0.19 g | Bulk | 2000 |
| EC103xyRP | EC103xy | 0.19 g | Reel Pack | 2000 |
| EC103xyAP | EC103xy | 0.19 g | Ammo Pack | 2000 |
| SxSyRP | SxSy | 0.08 g | Embossed Carrier | 2500 |

Note: x = Voltage, y = sensitivity

TO-92 (3-lead) Reel Pack (RP) Radial Leaded Specifications

Meets all EIA-468-C Standards



TO-92 (3-lead) Ammo Pack (AP) Radial Leaded Specifications

Meets all EIA-468-C Standards



Compak Embossed Carrier Reel Pack (RP) Specifications

Meets all EIA-481-1 Standards



Part Numbering System (TO-92)



Part Marking System

TO-92 (E Package)

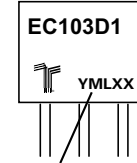

Date Code Marking
Y: Year Code
M: Month Code
L: Location Code
XX: Lot Serial Code

Part Numbering System (Compak)



Part Marking System (Compak)

Compak (C Package)

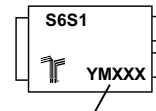

Date Code Marking
Y: Year Code
M: Month Code
XXX: Lot Trace Code



Компания «ЭлектроПласт» предлагает заключение долгосрочных отношений при поставках импортных электронных компонентов на взаимовыгодных условиях!

Наши преимущества:

- Оперативные поставки широкого спектра электронных компонентов отечественного и импортного производства напрямую от производителей и с крупнейших мировых складов;
- Поставка более 17-ти миллионов наименований электронных компонентов;
- Поставка сложных, дефицитных, либо снятых с производства позиций;
- Оперативные сроки поставки под заказ (от 5 рабочих дней);
- Экспресс доставка в любую точку России;
- Техническая поддержка проекта, помощь в подборе аналогов, поставка прототипов;
- Система менеджмента качества сертифицирована по Международному стандарту ISO 9001;
- Лицензия ФСБ на осуществление работ с использованием сведений, составляющих государственную тайну;
- Поставка специализированных компонентов (Xilinx, Altera, Analog Devices, Intersil, Interpoint, Microsemi, Aeroflex, Peregrine, Syfer, Eurofarad, Texas Instrument, Miteq, Cobham, E2V, MA-COM, Hittite, Mini-Circuits, General Dynamics и др.);

Помимо этого, одним из направлений компании «ЭлектроПласт» является направление «Источники питания». Мы предлагаем Вам помощь Конструкторского отдела:

- Подбор оптимального решения, техническое обоснование при выборе компонента;
- Подбор аналогов;
- Консультации по применению компонента;
- Поставка образцов и прототипов;
- Техническая поддержка проекта;
- Защита от снятия компонента с производства.



Как с нами связаться

Телефон: 8 (812) 309 58 32 (многоканальный)

Факс: 8 (812) 320-02-42

Электронная почта: org@eplast1.ru

Адрес: 198099, г. Санкт-Петербург, ул. Калинина, дом 2, корпус 4, литера А.