

ZXTPS717MC

**12V PNP LOW SATURATION TRANSISTOR AND
40V, 1A SCHOTTKY DIODE COMBINATION**

Features and Benefits

PNP Transistor

- $BV_{CEO} > -12V$
- $I_C = -4A$ Continuous Collector Current
- Low Saturation Voltage (-140mV max @ -1A)
- $R_{SAT} = 65m\Omega$ for a low equivalent On-Resistance
- h_{FE} characterized up to -10A for high current gain hold up

Schottky Diode

- $BV_R > 40V$
- $I_{FAV} = 3A$ Average Peak Forward Current
- Low $V_F < 500mV$ (@1A) for reduced power loss
- Fast switching due to Schottky barrier
- Low profile 0.8mm high package for thin applications
- $R_{\theta JA}$ efficient, 40% lower than SOT26
- 6mm² footprint, 50% smaller than TSOP6 and SOT26
- **Lead-Free, RoHS Compliant (Note 1)**
- **Halogen and Antimony Free. "Green" Device (Note 2)**
- **Qualified to AEC-Q101 Standards for High Reliability**

Mechanical Data

- Case: DFN3020B-8
- Case Material: Molded Plastic, "Green" Molding Component
- Terminals: Pre-Plated NiPdAu leadframe
- Nominal package height: 0.8mm
- UL Flammability Rating 94V-0
- Moisture Sensitivity: Level 1 per J-STD-020
- Weight: 0.013 grams (approximate)

Applications

- DC – DC Converters
- Charging circuits
- Mobile phones
- Motor control
- Portable applications

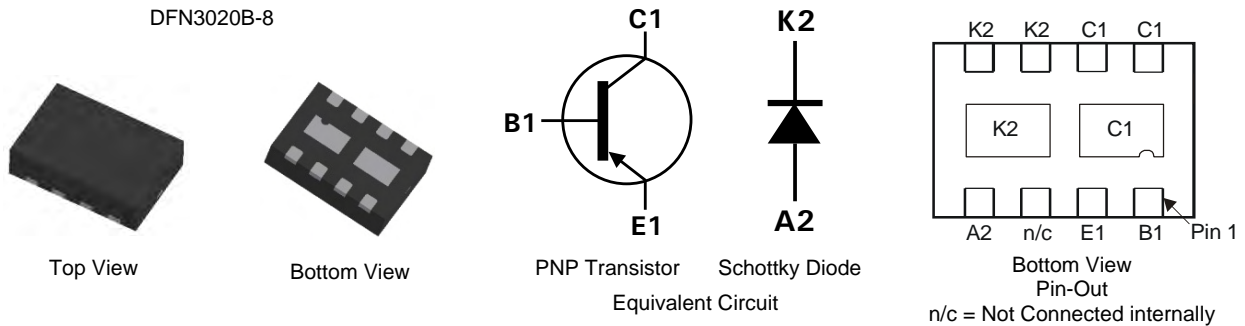

Ordering Information (Note 3)

Product	Marking	Reel size (inches)	Tape width (mm)	Quantity per reel
ZXTPS717MCTA	1S1	7	8	3000

- Notes:
1. No purposefully added lead.
 2. Diodes Inc's "Green" Policy can be found on our website <http://www.diodes.com>
 3. For packaging details, go to our website <http://www.diodes.com>

Marking Information



1S1 = Product type marking code
Top view, dot denotes pin 1

PNP - Maximum Ratings @ $T_A = 25^\circ\text{C}$ unless otherwise specified

Parameter	Symbol	Limit	Unit
Collector-Base Voltage	V_{CBO}	-20	V
Collector-Emitter Voltage	V_{CEO}	-12	
Emitter-Base Voltage	V_{EBO}	-7	
Peak Pulse Current	I_{CM}	-12	A
Continuous Collector Current	(Notes 4 and 7)	-4	
	(Notes 5 and 7)	-4.4	
Base Current	I_B	-1	

PNP - Thermal Characteristics @ $T_A = 25^\circ\text{C}$ unless otherwise specified

Characteristic	Symbol	Value	Unit
Power Dissipation Linear Derating Factor	P_D	1.5	W mW/°C
		12	
		2.45	
		19.6	
		1.13	
Thermal Resistance, Junction to Ambient	$R_{\theta JA}$	8	°C/W
		1.7	
		13.6	
		83.3	
		51.0	
Thermal Resistance, Junction to Lead	$R_{\theta JL}$	111	°C/W
		73.5	
		17.1	
Operating and Storage Temperature Range	T_J, T_{STG}	-55 to +150	°C

- Notes:
4. For a dual device surface mounted on 28mm x 28mm (8cm²) FR4 PCB with high coverage of single sided 2 oz copper, in still air conditions; the device is measured when operating in a steady-state condition. The heatsink is split in half with the exposed collector and cathode pads connected to each half.
 5. Same as note (4), except the device is measured at $t < 5$ sec.
 6. Same as note (4), except the device is surface mounted on 31mm x 31mm (10cm²) FR4 PCB with high coverage of single sided 1oz copper.
 7. For a dual device with one active die.
 8. For dual device with 2 active die running at equal power.
 9. Thermal resistance from junction to solder-point (on the exposed collector pad).

PNP - Thermal Characteristics

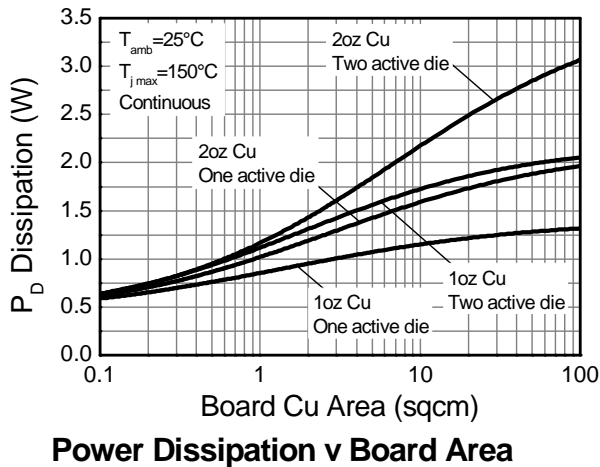
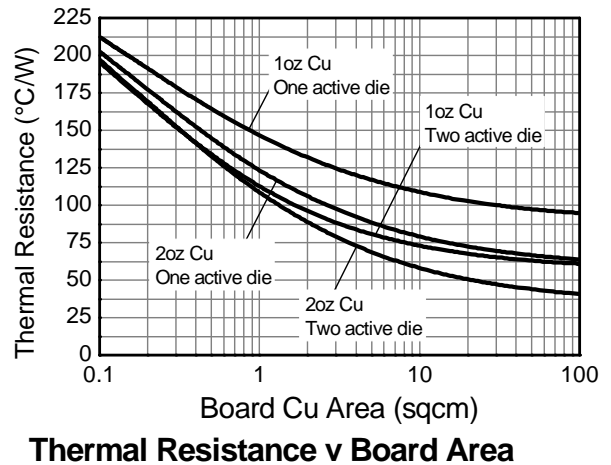
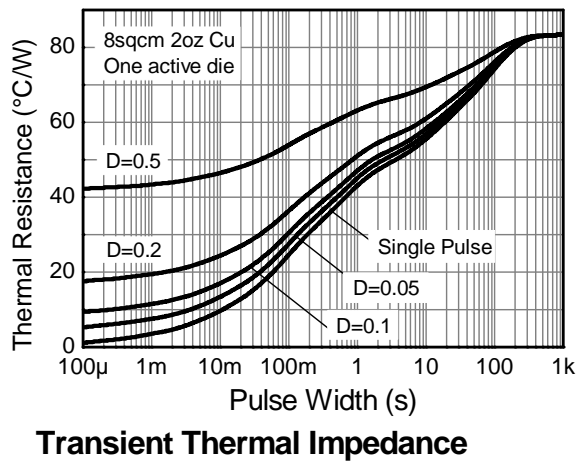
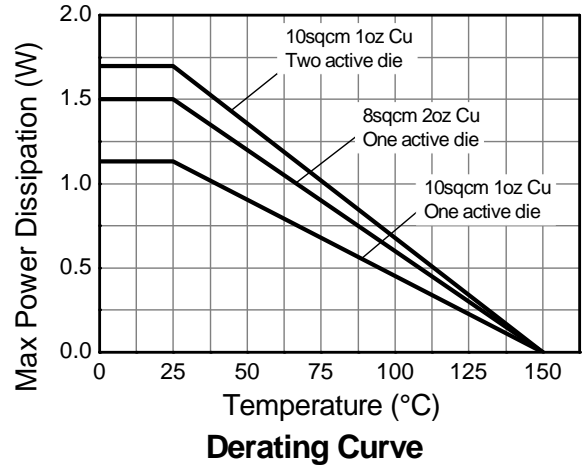
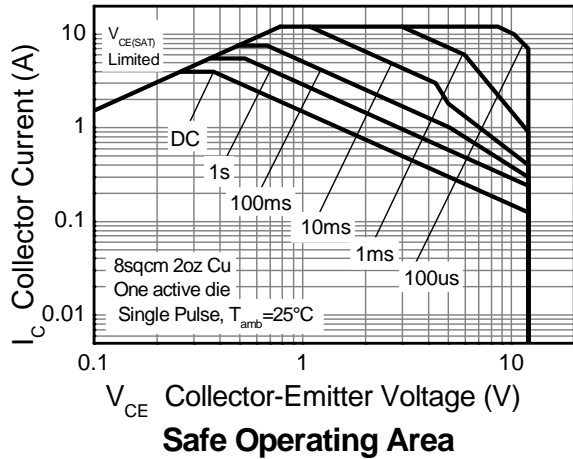

Schottky - Maximum Ratings @ $T_A = 25^\circ\text{C}$ unless otherwise specified

Parameter	Symbol	Limit	Unit	
Continuous Reverse Voltage	V_R	40	V	
Continuous Forward Current	I_F	1.85	A	
Repetitive Peak Forward Current	I_{FRM}	3		
Non-Repetitive Peak Forward Surge Current	I_{FSM}	$t \leq 100\mu\text{s}$		12
		$t \leq 10\text{ms}$		7

Schottky - Thermal Characteristics @ $T_A = 25^\circ\text{C}$ unless otherwise specified

Characteristic	Symbol	Value	Unit
Power Dissipation Linear Derating Factor	P_D	(Notes 10 & 13)	1.2
		(Notes 11 & 13)	12
		(Notes 12 & 13)	2
		(Notes 12 & 14)	20
		(Notes 12 & 14)	0.9
Thermal Resistance, Junction to Ambient	$R_{\theta JA}$	(Notes 10 & 13)	9
		(Notes 11 & 13)	1.36
		(Notes 12 & 13)	13.6
		(Notes 12 & 14)	83.3
Thermal Resistance, Junction to Lead	$R_{\theta JL}$	20.2	$^\circ\text{C}/\text{W}$
Storage Temperature Range	T_{STG}	-55 to +150	$^\circ\text{C}$
Maximum Junction Temperature	T_J	125	

- Notes:
10. For a dual device surface mounted on 28mm x 28mm (8cm²) FR4 PCB with high coverage of single sided 2 oz copper, in still air conditions; the device is measured when operating in a steady-state condition. The heatsink is split in half with the exposed cathode and collector pads connected to each half.
 11. Same as note (10), except the device is measured at $t < 5$ sec.
 12. Same as note (10), except the device is surface mounted on 31mm x 31mm (10cm²) FR4 PCB with high coverage of single sided 1oz copper.
 13. For a dual device with one active die.
 14. For dual device with 2 active die running at equal power.
 15. Thermal resistance from junction to solder-point (on the exposed cathode pad).

Schottky - Thermal Characteristics

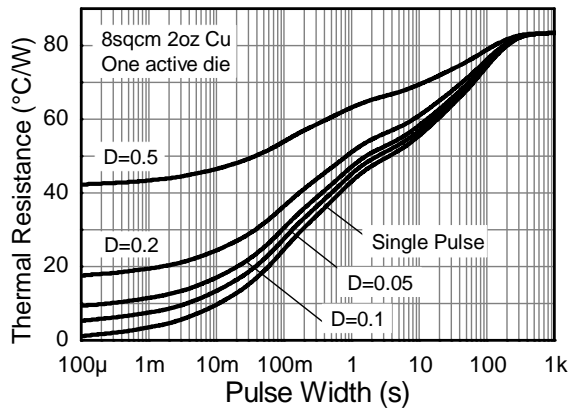

Transient Thermal Impedance

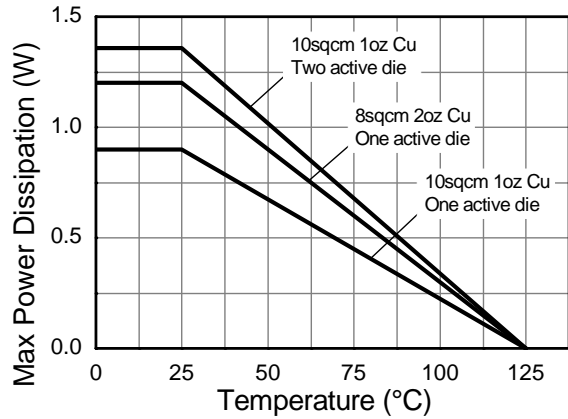

Derating Curve



Power Dissipation v Board Area



Thermal Resistance v Board Area

PNP - Electrical Characteristics @T_A = 25°C unless otherwise specified

Characteristic	Symbol	Min	Typ	Max	Unit	Test Condition
Collector-Base Breakdown Voltage	BV _{CBO}	-20	-35	-	V	I _C = -100μA
Collector-Emitter Breakdown Voltage (Note 16)	BV _{CEO}	-12	-25	-	V	I _C = -10mA
Emitter-Base Breakdown Voltage	BV _{EBO}	-7	-8.5	-	V	I _E = -100μA
Collector Cutoff Current	I _{CBO}	-	-	-100	nA	V _{CB} = -16V
Emitter Cutoff Current	I _{EBO}	-	-	-100	nA	V _{EB} = -6V
Collector Emitter Cutoff Current	I _{CES}	-	-	-100	nA	V _{CES} = -10V
Static Forward Current Transfer Ratio (Note 16)	h _{FE}	300	475	-	-	I _C = -10mA, V _{CE} = -2V
		300	450	-		I _C = -100mA, V _{CE} = -2V
		180	275	-		I _C = -2.5A, V _{CE} = -2V
		60	100	-		I _C = -8A, V _{CE} = -2V
		45	70	-		I _C = -10A, V _{CE} = -2V
Collector-Emitter Saturation Voltage (Note 16)	V _{CE(sat)}	-	-10	-17	mV	I _C = -0.1A, I _B = -10mA
		-	-100	-140		I _C = -1A, I _B = -10mA
		-	-100	-150		I _C = -1.5A, I _B = -50mA
		-	-195	-300		I _C = -3A, I _B = -50mA
		-	-240	-310		I _C = -4A, I _B = -150mA
Base-Emitter Turn-On Voltage (Note 16)	V _{BE(on)}	-	-0.87	-0.96	V	I _C = -4A, V _{CE} = -2V
Base-Emitter Saturation Voltage (Note 16)	V _{BE(sat)}	-	-0.97	-1.07	V	I _C = -4A, I _B = -150mA
Output Capacitance	C _{obo}	-	21	30	pF	V _{CB} = -10V, f = 1MHz
Transition Frequency	f _T	100	110	-	MHz	V _{CE} = -10V, I _C = -50mA, f = 100MHz
Turn-on Time	t _{on}	-	70	-	Ns	V _{CC} = -6V, I _C = -2A
Turn-off Time	t _{off}	-	130	-	Ns	I _{B1} = I _{B2} = -50mA

Schottky - Electrical Characteristics @T_A = 25°C unless otherwise specified

Characteristic	Symbol	Min	Typ	Max	Unit	Test Condition
Reverse Breakdown Voltage	BV _R	40	60	-	V	I _R = -300μA
Forward Voltage (Note 16)	V _F	-	240	270	mV	I _F = 50mA
		-	265	290		I _F = 100mA
		-	305	340		I _F = 250mA
		-	355	400		I _F = 500mA
		-	390	450		I _F = 750mA
		-	425	500		I _F = 1000mA
		-	495	600		I _F = 1500mA
		-	420	-		I _F = 1000mA, T _A = 100°C
Reverse Current	I _R	-	50	100	μA	V _R = 30V
Diode Capacitance	C _D	-	25	-	pF	V _R = 25V, f = 1MHz
Reverse Recovery Time	t _{rr}	-	12	-	ns	switched from I _F = 500mA to I _R = 500mA Measured at I _R = 50mA

Notes: 16. Measured under pulsed conditions. Pulse width ≤ 300μs. Duty cycle ≤ 2%.

PNP - Typical Electrical Characteristics

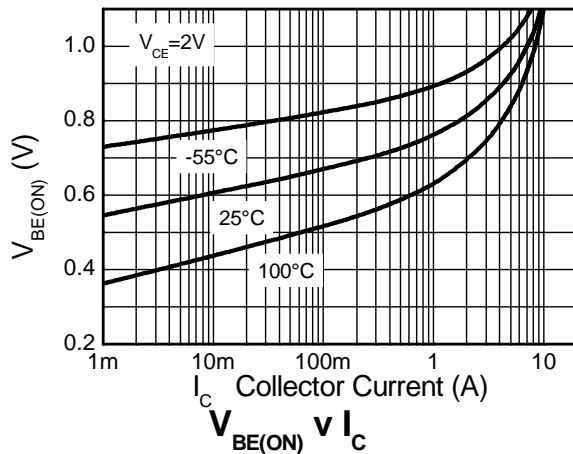
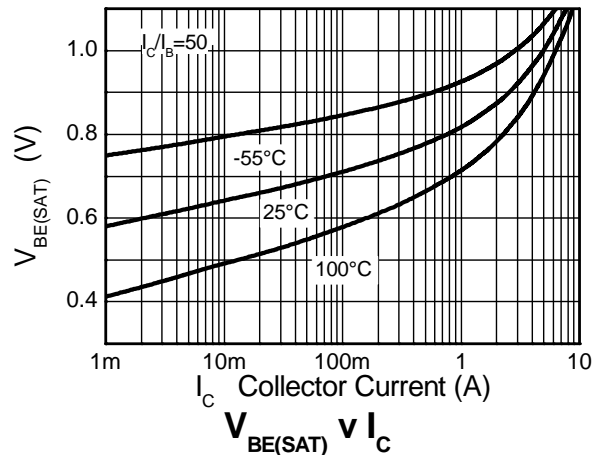
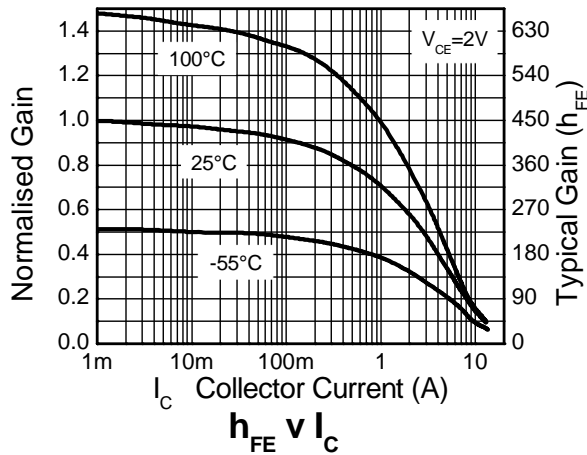
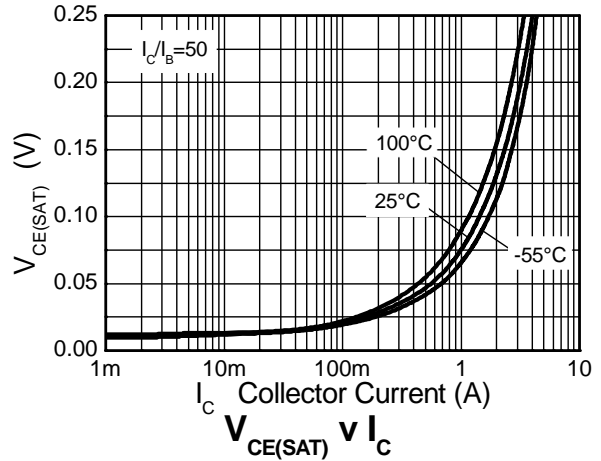
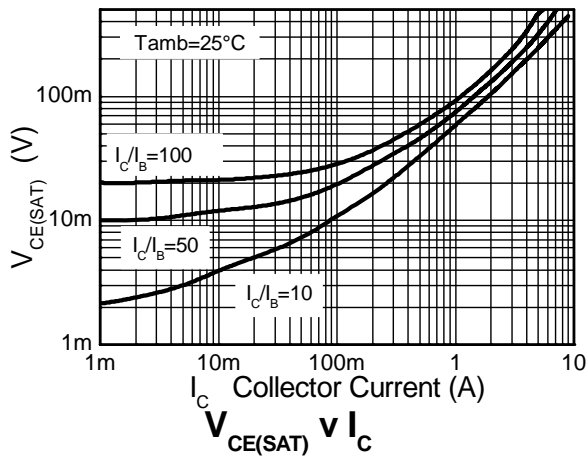

Schottky - Typical Electrical Characteristics



ZXTPS717MC

Package Outline Dimensions



DFN3020B-8			
Dim	Min	Max	Typ
A	0.77	0.83	0.80
A1	0	0.05	0.02
A3	-	-	0.15
b	0.25	0.35	0.30
D	2.95	3.075	3.00
D2	0.82	1.02	0.92
D4	1.01	1.21	1.11
e	-	-	0.65
E	1.95	2.075	2.00
E2	0.43	0.63	0.53
L	0.25	0.35	0.30
Z	-	-	0.375
All Dimensions in mm			

Suggested Pad Layout



Dimensions	Value (in mm)
C	0.650
G	0.285
G1	0.090
X	0.400
X1	1.120
Y	0.730
Y1	0.500
Y2	0.365

IMPORTANT NOTICE

DIODES INCORPORATED MAKES NO WARRANTY OF ANY KIND, EXPRESS OR IMPLIED, WITH REGARDS TO THIS DOCUMENT, INCLUDING, BUT NOT LIMITED TO, THE IMPLIED WARRANTIES OF MERCHANTABILITY AND FITNESS FOR A PARTICULAR PURPOSE (AND THEIR EQUIVALENTS UNDER THE LAWS OF ANY JURISDICTION).

Diodes Incorporated and its subsidiaries reserve the right to make modifications, enhancements, improvements, corrections or other changes without further notice to this document and any product described herein. Diodes Incorporated does not assume any liability arising out of the application or use of this document or any product described herein; neither does Diodes Incorporated convey any license under its patent or trademark rights, nor the rights of others. Any Customer or user of this document or products described herein in such applications shall assume all risks of such use and will agree to hold Diodes Incorporated and all the companies whose products are represented on Diodes Incorporated website, harmless against all damages.

Diodes Incorporated does not warrant or accept any liability whatsoever in respect of any products purchased through unauthorized sales channel. Should Customers purchase or use Diodes Incorporated products for any unintended or unauthorized application, Customers shall indemnify and hold Diodes Incorporated and its representatives harmless against all claims, damages, expenses, and attorney fees arising out of, directly or indirectly, any claim of personal injury or death associated with such unintended or unauthorized application.

Products described herein may be covered by one or more United States, international or foreign patents pending. Product names and markings noted herein may also be covered by one or more United States, international or foreign trademarks.

LIFE SUPPORT

Diodes Incorporated products are specifically not authorized for use as critical components in life support devices or systems without the express written approval of the Chief Executive Officer of Diodes Incorporated. As used herein:

- C. Life support devices or systems are devices or systems which:
1. are intended to implant into the body, or
 2. support or sustain life and whose failure to perform when properly used in accordance with instructions for use provided in the labeling can be reasonably expected to result in significant injury to the user.
- D. A critical component is any component in a life support device or system whose failure to perform can be reasonably expected to cause the failure of the life support device or to affect its safety or effectiveness.

Customers represent that they have all necessary expertise in the safety and regulatory ramifications of their life support devices or systems, and acknowledge and agree that they are solely responsible for all legal, regulatory and safety-related requirements concerning their products and any use of Diodes Incorporated products in such safety-critical, life support devices or systems, notwithstanding any devices- or systems-related information or support that may be provided by Diodes Incorporated. Further, Customers must fully indemnify Diodes Incorporated and its representatives against any damages arising out of the use of Diodes Incorporated products in such safety-critical, life support devices or systems.

Copyright © 2011, Diodes Incorporated

www.diodes.com



Компания «ЭлектроПласт» предлагает заключение долгосрочных отношений при поставках импортных электронных компонентов на взаимовыгодных условиях!

Наши преимущества:

- Оперативные поставки широкого спектра электронных компонентов отечественного и импортного производства напрямую от производителей и с крупнейших мировых складов;
- Поставка более 17-ти миллионов наименований электронных компонентов;
- Поставка сложных, дефицитных, либо снятых с производства позиций;
- Оперативные сроки поставки под заказ (от 5 рабочих дней);
- Экспресс доставка в любую точку России;
- Техническая поддержка проекта, помощь в подборе аналогов, поставка прототипов;
- Система менеджмента качества сертифицирована по Международному стандарту ISO 9001;
- Лицензия ФСБ на осуществление работ с использованием сведений, составляющих государственную тайну;
- Поставка специализированных компонентов (Xilinx, Altera, Analog Devices, Intersil, Interpoint, Microsemi, Aeroflex, Peregrine, Syfer, Eurofarad, Texas Instrument, Miteq, Cobham, E2V, MA-COM, Hittite, Mini-Circuits, General Dynamics и др.);

Помимо этого, одним из направлений компании «ЭлектроПласт» является направление «Источники питания». Мы предлагаем Вам помощь Конструкторского отдела:

- Подбор оптимального решения, техническое обоснование при выборе компонента;
- Подбор аналогов;
- Консультации по применению компонента;
- Поставка образцов и прототипов;
- Техническая поддержка проекта;
- Защита от снятия компонента с производства.



Как с нами связаться

Телефон: 8 (812) 309 58 32 (многоканальный)

Факс: 8 (812) 320-02-42

Электронная почта: org@eplast1.ru

Адрес: 198099, г. Санкт-Петербург, ул. Калинина, дом 2, корпус 4, литера А.