

KUHP series

30 Amp Power Relays

File E22575

File LR15734-123

Users should thoroughly review the technical data before selecting a product part number. It is recommended that users also seek out the pertinent approvals files of the agencies/laboratories and review them to ensure the product meets the requirements for a given application.

Features

- AC coils 6-277VAC 50/60 Hz., DC 6-110VDC.
- Contact arrangement up to DPDT.
- .250" combination push-on/solder terminals or PC terminals.
- Side flange and top flange mounting.
- Designed to meet VDE space requirements.
- Class B coil insulation.

Contact Data @ 25°C

Arrangements: 1 Form C (SPDT) and 2 Form C (DPDT).

Material: Silver or silver-cadmium oxide.

Expected Mechanical Life: 10 million operations.

Contact Ratings

Contact Arrangement	UL/CSA Ratings	Expected Life
1 Form C Single Pole Double Throw	30A 120/240VAC 1 HP @ 120VAC, 1 1/2 HP @ 240VAC 25A @ 28VDC	100,000 ops.
2 Form C Double Pole Double Throw	20A @ 120/240VAC 3/4 HP @ 120VAC 1 1/2 HP @ 240VAC 20A @ 28VDC 7A @ 120VAC (Tungsten)*	100,000 ops.

*NO contacts only.

Initial Dielectric Strength

- Between Open Contacts:** 1,200V rms.
- Between Adjacent Contacts:** 3,750V rms.
- Between Contacts and Coil:** 3,750V rms.
- Between Coil and Frame:** 2,000V rms.

Coil Data @ 25°C

Voltage: 6-110VDC and 6-277VAC.

Nominal Power:

DC Coils: 1.2 Watts.

AC Coils: 2.7VA.

Duty Cycle: Continuous.

Initial Insulation Resistance: 100 megohms, min.

Insulation: Class B, 130°C.

Coil Data

	Nominal Voltage	DC Resistance in Ohms ± 10%*	Must Operate Voltage	Nominal Coil Current (mA)
DC Coils	6	32.1	4.5	187
	12	120	9.0	100
	24	472	18.0	51
	48	1,800	36.0	26.7
	110	10,000	82.5	11
AC Coils	6	4.2	5.1	460
	12	18	10.2	230
	24	72	20.4	115
	120	1,700	102.0	24
	240	7,200	204.0	12
	277	10,250	235.5	9

*±15% for AC coils.

Operate Data @ 25°C

Must Operate Voltage:

DC Coils: 75% of nominal.

AC Coils: 85% of nominal.

Operate Time (Excluding Bounce): 20 milliseconds, typical, at nominal voltage.

Release Time (Excluding Bounce): 20 milliseconds, typical, at nominal voltage.

Environmental Data

Temperature Range: (Operating)

DC Coils: -45°C to +70°C.

AC Coils: -45°C to +45°C.

Shock: 15g's, 11 ms (non-operating).

Vibration: .065" double amplitude, 10-55 Hz.

Mechanical Data

Termination: .250" quick connect/solder; and PC board.

Enclosure: Polycarbonate dust cover.

Weight: 3.2 oz. (92g) approximately.

Ordering Information

Typical Part No. ▶	KUHP-	11	A	5	1	-120
1. Basic Series and Type: KUHP = Enclosed 20/30 amp relay.						
2. Contact Arrangement and Rating: 5 = 1C (SPDT); 30 amps. 11 = 2C (DPDT); 20 amps.						
3. Coil Input: A = AC, 50/60 Hz. D = DC						
4. Mountings: 1 = PLAIN CASE 5 = BRACKET MOUNT CASE T = TOP FLANGE CASE						
5. Terminals and Contact Materials: 1 = .250" (6.35mm) quick connect/solder; silver-cadmium oxide. 7 = .047" (1.19mm) printed circuit; silver-cadmium oxide.						
6. Coil Voltage: AC coils to 277VAC, 50/60 Hz. DC coils to 110VDC.						

NOTE: No sockets are available for this relay.

Our authorized distributors are more likely to maintain the following items in stock for immediate delivery.

KUHP-5A51-24	KUHP-5AT1-120	KUHP-5D51-24	KUHP-5DT1-24	KUHP-11A51-120	KUHP-11D51-12	KUHP-11DT1-12
KUHP-5A51-120	KUHP-5D51-12	KUHP-5DT1-12	KUHP-11A51-24	KUHP-11AT1-120	KUHP-11D51-24	KUHP-11DT1-24

Dimensions are shown for reference purposes only.

Dimensions are in inches over (millimeters) unless otherwise specified.

Specifications and availability subject to change.

www.tycoelectronics.com
Technical support:
Refer to inside back cover.

Outline Dimensions

Plain Case

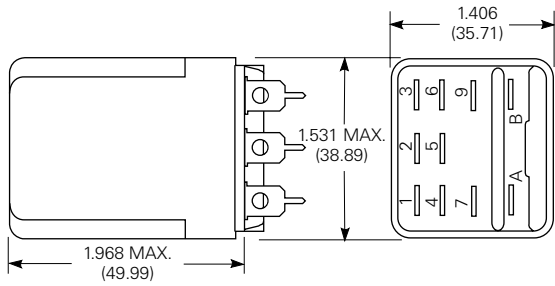

Top Flange Enclosure

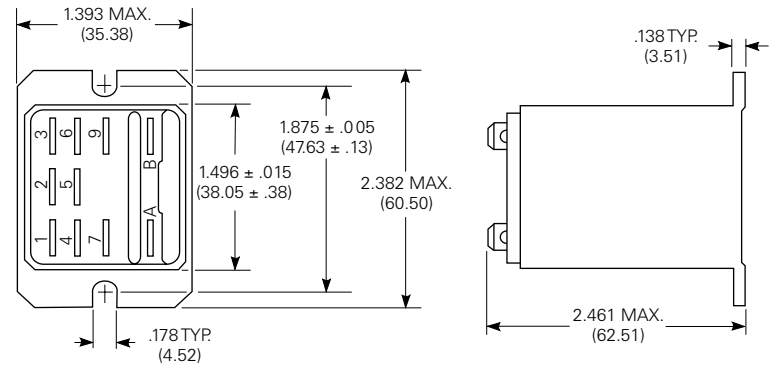

Bracket Mount Case

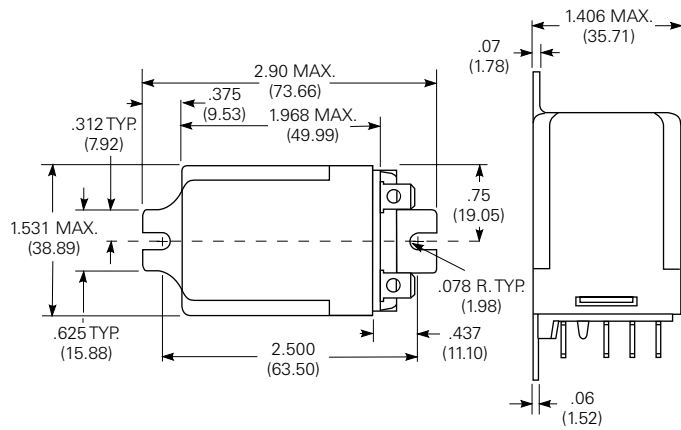

**Terminal Dimensions
.250" (6.35mm) Quick
Connect/Solder**

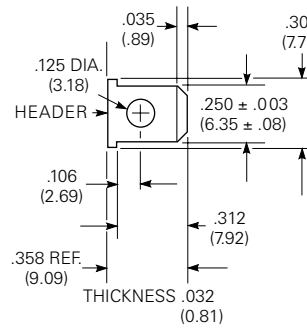

Printed Circuit

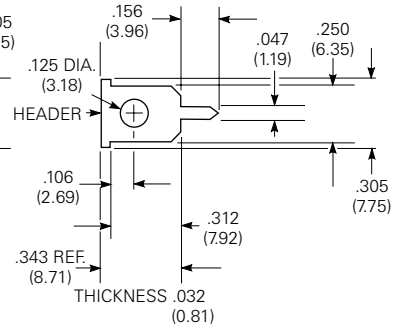

Wiring Diagrams

- 1 Form C
- 1 Form A (Delete 2)
- 1 Form B (Delete 5)

- 2 Form C
- 2 Form A (Delete 1 & 3)
- 2 Form B (Delete 4 & 6)

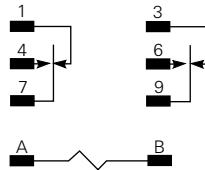
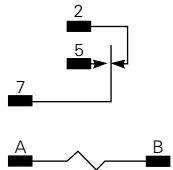

PC Board Layouts (Bottom Views)

1 Pole Model

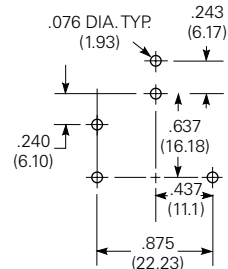

2 Pole Model

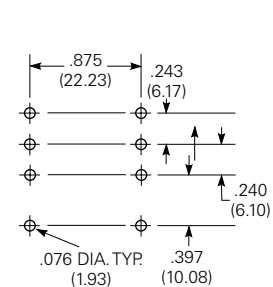



Компания «ЭлектроПласт» предлагает заключение долгосрочных отношений при поставках импортных электронных компонентов на взаимовыгодных условиях!

Наши преимущества:

- Оперативные поставки широкого спектра электронных компонентов отечественного и импортного производства напрямую от производителей и с крупнейших мировых складов;
- Поставка более 17-ти миллионов наименований электронных компонентов;
- Поставка сложных, дефицитных, либо снятых с производства позиций;
- Оперативные сроки поставки под заказ (от 5 рабочих дней);
- Экспресс доставка в любую точку России;
- Техническая поддержка проекта, помощь в подборе аналогов, поставка прототипов;
- Система менеджмента качества сертифицирована по Международному стандарту ISO 9001;
- Лицензия ФСБ на осуществление работ с использованием сведений, составляющих государственную тайну;
- Поставка специализированных компонентов (Xilinx, Altera, Analog Devices, Intersil, Interpoint, Microsemi, Aeroflex, Peregrine, Syfer, Eurofarad, Texas Instrument, Miteq, Cobham, E2V, MA-COM, Hittite, Mini-Circuits, General Dynamics и др.);

Помимо этого, одним из направлений компании «ЭлектроПласт» является направление «Источники питания». Мы предлагаем Вам помощь Конструкторского отдела:

- Подбор оптимального решения, техническое обоснование при выборе компонента;
- Подбор аналогов;
- Консультации по применению компонента;
- Поставка образцов и прототипов;
- Техническая поддержка проекта;
- Защита от снятия компонента с производства.



Как с нами связаться

Телефон: 8 (812) 309 58 32 (многоканальный)

Факс: 8 (812) 320-02-42

Электронная почта: org@eplast1.ru

Адрес: 198099, г. Санкт-Петербург, ул. Калинина, дом 2, корпус 4, литера А.