

# General Purpose AC/DC EMI Filter with High Attenuation Performance



- Rated currents from 1 to 30 A
- High performance filter attenuation
- High differential-mode attenuation
- Optional medical versions (B type)
- Optional safety versions (A type)
- Optional enhanced performance versions
- Optional overvoltage protection (Z type)



### Performance indicators

Attenuation performance



Rated current [A]

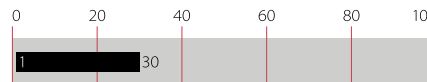

### Approvals



### Features and benefits

- FN 2030 filters are designed for easy and fast chassis mounting
- The FN 2030 filters are also available as B versions with no Y-capacitors for medical applications as well as A versions with low capacitance for safety critical applications with a requirement for low leakage currents
- FN 2030 filters offer an optimized filter range for high performance AC and DC applications, in same compact size (M, N1 types)
- All filters provide an exceptional conducted attenuation performance, based on chokes with high permeable core material and excellent thermal behavior
- The higher inductivity versus amperage offers increased attenuation performance with same form factor compared to FN 2010 and FN 2020 filter series
- All FN 2030 filters can be delivered with optional surge pulse protection (Z type).
- Various terminal options allow you to select the desired connection style

### Technical specifications

<b>Rated voltage*</b>	250 VAC, 50/60 Hz; 250 VDC
<b>Operating frequency</b>	dc to 400 Hz
<b>Rated currents</b>	1 to 30 A @ 40°C max.
<b>High potential test voltage</b>	P → PE 2000 VAC for 2 sec (equiv. cap <88 nF) P → PE 2550 VDC for 2 sec (equiv. cap >88 nF) P → PE 2500 VAC for 2 sec (B types) P → N 1100 VDC for 2 sec
<b>Temperature range (operation and storage)</b>	-25°C to +100°C (25/100/21)
<b>Certified to</b>	UL 1283, CSA 22.2 No. 8 1986, IEC/EN 60939 (applies to AC and DC applications)
<b>Flammability corresponding to</b>	UL 94 V-2 or better
<b>Surge pulse protection (Z type)</b>	2 kV (P-N), IEC 61000-4-5
<b>MTBF @ 40°C/230 V (Mil-HB-217F)</b>	2,200,000 hours (1 to 10 A types) 1,200,000 hours (12 to 30 A types)

\*maximum RMS operating voltage at rated frequency or the maximum DC operating voltage



### Typical application

- Electrical and electronic equipment
- Consumer goods
- Household equipment
- Medical equipment
- Electronic data processing equipment
- Office automation and datacom equipment
- Various noisy applications requiring high filter performance

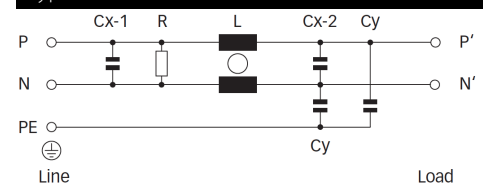
### Typical electrical schematic



## Filter selection table

Filter*	Rated current @ 40°C (25°C)	Leakage current** @ 250 VAC/50 Hz (@ 120 VAC/60 Hz)	Inductance L	Capacitance		Resistance R	Input/Output connections			Weight [g]
				Cx	Cy					
	[A]	[mA]	[mH]	[µF]	[nF]	[kΩ]				
<b>FN 2030-1-..</b>	1 (1.1)	0.31 (0.18)	20	0.22	2.2	1000	-06	-07		58
<b>FN 2030-3-..</b>	3 (3.4)	0.47 (0.27)	14	0.33	3.3	1000	-06	-07		87
<b>FN 2030-4-..</b>	4 (4.5)	0.47 (0.27)	14	0.33	3.3	1000	-06	-07		92
<b>FN 2030-6-..</b>	6 (6.7)	0.66 (0.38)	8	0.47	4.7	680	-06	-07		100
<b>FN 2030-8-..</b>	8 (8.9)	0.66 (0.38)	8	0.47	4.7	680	-06	-07		170
<b>FN 2030-10-..</b>	10 (11.2)	0.66 (0.38)	8	0.47	4.7	680	-06	-07		196
<b>FN 2030-12-..</b>	12 (13.4)	0.79 (0.45)	4	1.0	10	330	-06	-07		185
<b>FN 2030-16-..</b>	16 (17.9)	0.79 (0.45)	4	1.0	10	330	-06	-07		225
<b>FN 2030-20-..</b>	20 (22.4)	0.79 (0.45)	4	1.0	10	330	-06		-08	285
<b>FN 2030-30-08</b>	30 (33.5)	0.79 (0.45)	2	1.0	10	330			-08	326
<b>FN 2030 A-1-..</b>	1 (1.1)	0.07 (0.04)	20	0.22	0.47	1000	-06	-07		58
<b>FN 2030 A-3-..</b>	3 (3.4)	0.07 (0.04)	14	0.33	0.47	1000	-06	-07		87
<b>FN 2030 A-4-..</b>	4 (4.5)	0.07 (0.04)	14	0.33	0.47	1000	-06	-07		92
<b>FN 2030 A-6-..</b>	6 (6.7)	0.07 (0.04)	8	0.47	0.47	680	-06	-07		100
<b>FN 2030 A-8-..</b>	8 (8.9)	0.07 (0.04)	8	0.47	0.47	680	-06	-07		170
<b>FN 2030 A-10-..</b>	10 (11.2)	0.07 (0.04)	8	0.47	0.47	680	-06	-07		196
<b>FN 2030 A-12-..</b>	12 (13.4)	0.07 (0.04)	4	1.0	0.47	330	-06	-07		185
<b>FN 2030 A-16-..</b>	16 (17.9)	0.07 (0.04)	4	1.0	0.47	330	-06	-07		225
<b>FN 2030 A-20-..</b>	20 (22.4)	0.07 (0.04)	4	1.0	0.47	330	-06		-08	285
<b>FN 2030 A-30-08</b>	30 (33.5)	0.07 (0.04)	2	1.0	0.47	330			-08	326
<b>FN 2030 B-1-..</b>	1 (1.1)	0.00	20	0.22		1000	-06	-07		58
<b>FN 2030 B-3-..</b>	3 (3.4)	0.00	14	0.33		1000	-06	-07		87
<b>FN 2030 B-4-..</b>	4 (4.5)	0.00	14	0.33		1000	-06	-07		92
<b>FN 2030 B-6-..</b>	6 (6.7)	0.00	8	0.47		680	-06	-07		100
<b>FN 2030 B-8-..</b>	8 (8.9)	0.00	8	0.47		680	-06	-07		170
<b>FN 2030 B-10-..</b>	10 (11.2)	0.00	8.45	0.47		680	-06	-07		196
<b>FN 2030 B-12-..</b>	12 (13.4)	0.00	4	1.0		330	-06	-07		185
<b>FN 2030 B-16-..</b>	16 (17.9)	0.00	4	1.0		330	-06	-07		225
<b>FN 2030 B-20-..</b>	20 (22.4)	0.00	4	1.0		330	-06		-08	285
<b>FN 2030 B-30-08</b>	30 (33.5)	0.00	2	1.0		330			-08	326
<b>Enhanced performance</b>										
<b>FN 2030 N1-1-06</b>	1 (1.1)	5.34 (3.08)	20	0.22	68	1000	-06			65
<b>FN 2030 M-3-06</b>	3 (3.4)	3.69 (2.28)	14	0.33	47	1000	-06			110
<b>FN 2030 M-4-06</b>	4 (4.5)	3.69 (2.28)	14	0.33	47	1000	-06			110
<b>FN 2030 M-6-06</b>	6 (6.7)	3.69 (2.28)	8	0.47	47	680	-06			120
<b>FN 2030 N1-8-06</b>	8 (8.9)	5.34 (3.08)	8	0.47	68	3680	-06			200
<b>FN 2030 N1-10-06</b>	10 (11.2)	5.34 (3.08)	8	0.47	68	680	-06			200
<b>FN 2030 N1-12-06</b>	12 (13.4)	5.34 (3.08)	4	1.0	68	330	-06			210
<b>FN 2030 M-16-06</b>	16 (17.9)	3.69 (2.28)	4	1.0	47	330	-06			265
<b>FN 2030 M-20-..</b>	20 (22.4)	3.69 (2.28)	4	1.0	47	330	-06		-08	326
<b>FN 2030 M-30-08</b>	30 (33.5)	3.69 (2.28)	2	1.0	47	330			-08	346

\* To compile a complete part number, please replace the -.. with the required I/O connection style. For surge pulse protection, please add Z (e.g. FN 2030Z-10-06, FN 2030BZ-20-08). The different letters code the used Cy values in the filter type (A = 0.47nF; M = 47nF; N1 = 47nF)

\*\* Maximum leakage under usual AC operating conditions (acc. IEC60939-3). Note: if the neutral line is interrupted, worst case leakage could reach twice this level. Leakage current for DC application is 0 mA

## Typical filter attenuation

Per CISPR 17; A=50 Ω/50 Ω sym; B=50 Ω/50 Ω asym

### Standard Types

1 to 4 A types

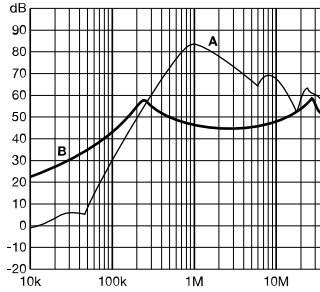

6 to 10 A types

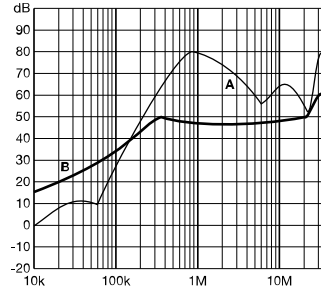

12 to 20 A types

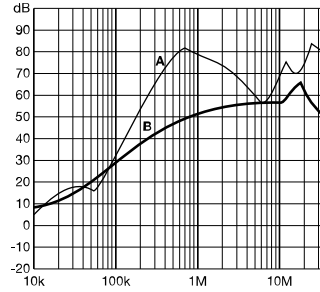

30 A types

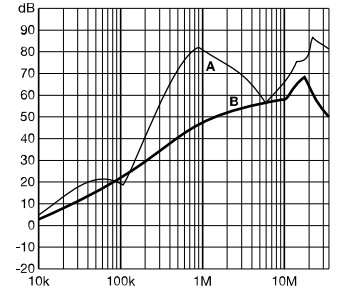

### Enhanced Performance Types

1 A types

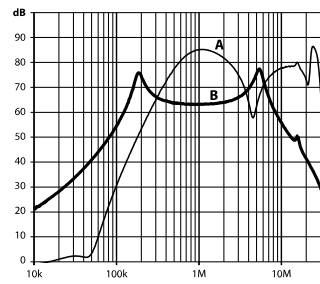

3 A types

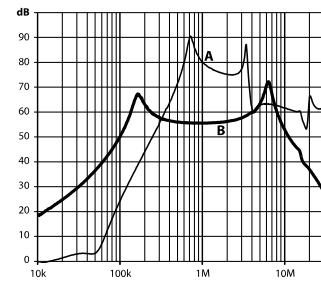

4 A types

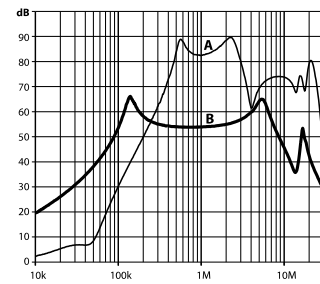

6 A types

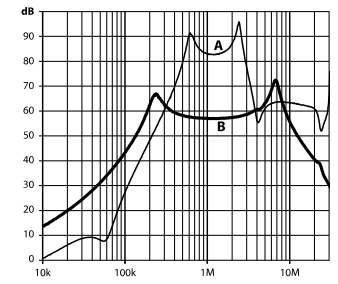

8 A types

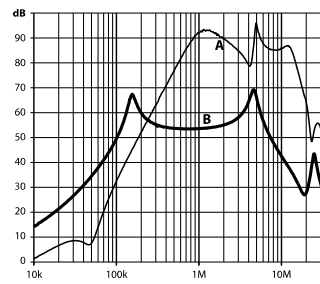

10 A types

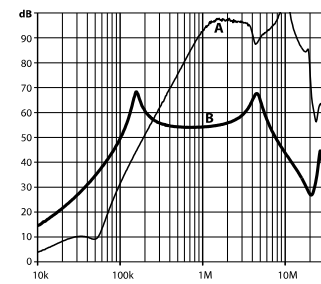

12 A types

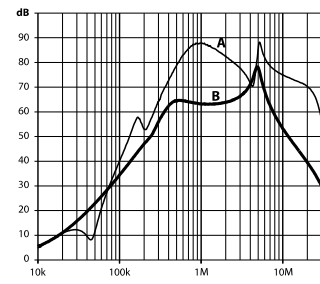

16 A types

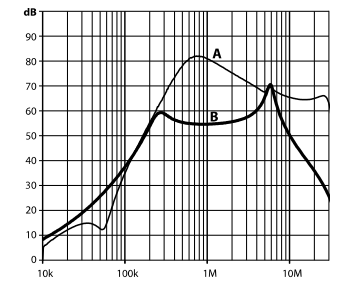

20 A types

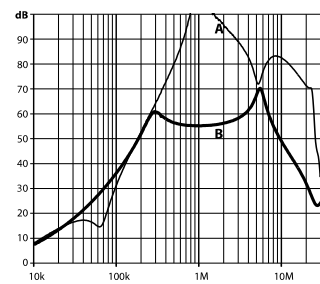

30 A types

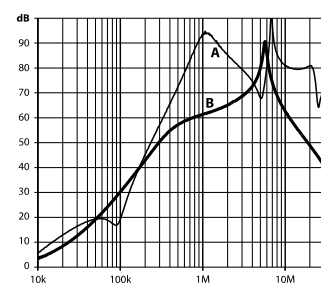

Product selector		
FN 2030-xy-xx-yy		
	06	Faston 6.3 × 0.8 mm (spade/soldering)
	07	Wire leads
	08	Studs (M4 screws)
	1 to 60	Rated current
	Blank	Standard version
	Z	With surge protection
	Blank	Standard version
	A	Safety version
	B	Medical version
	N1/M	High performance version

**Mechanical data**

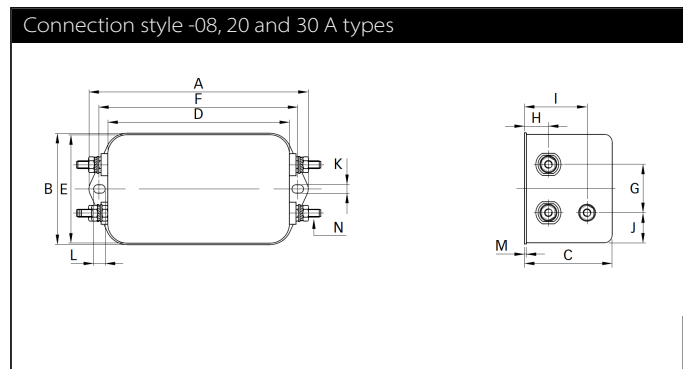
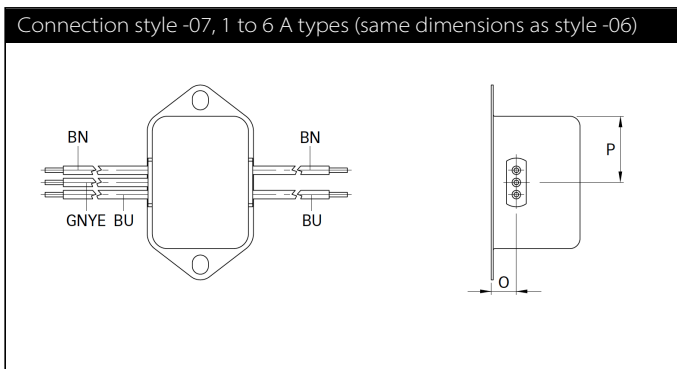
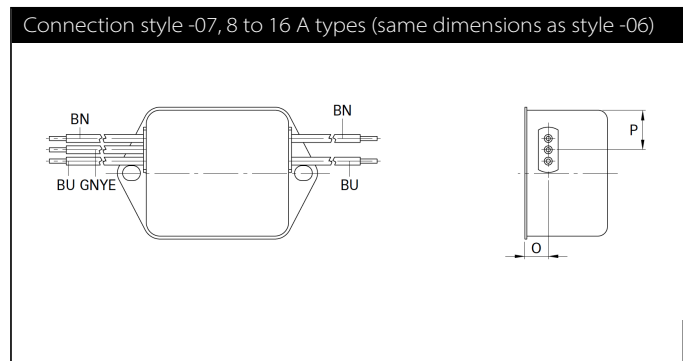
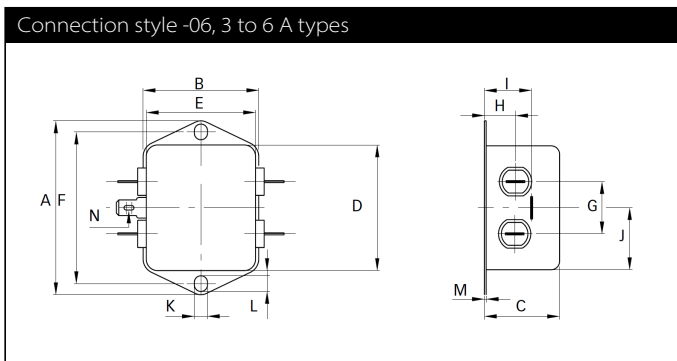
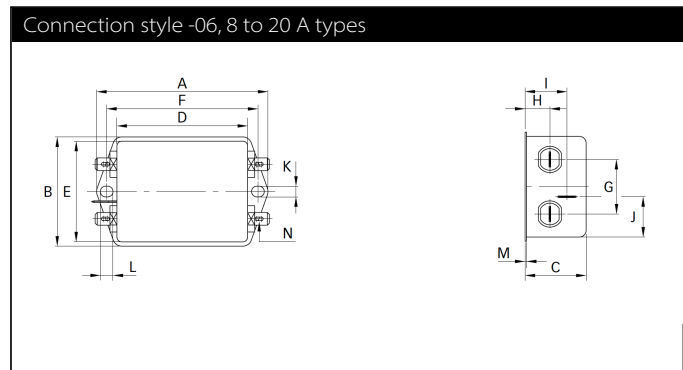
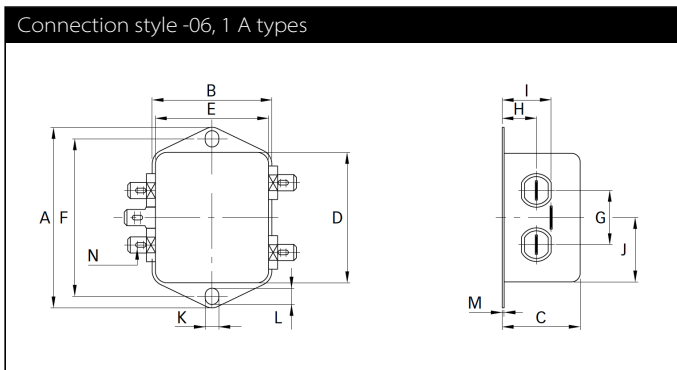

## Dimensions

	1 A	3 A	4 A	6 A	8 A	10 A	12 A	16 A	20 A	30 A	Tolerances
<b>A</b>	64	71	71	71	85	85	85	85	85	85	±0.5
<b>B</b>	35	46.6	46.6	46.6	54	54	54	54	54	54	±0.5
<b>C</b>	24.3	22.3	22.3	22.3	30.3	30.3	30.3	40.3	40.3	40.3	±0.5
<b>D</b>	43.5	50.5	50.5	50.5	64.8	64.8	64.8	64.8	64.8	64.8	±0.5
<b>E</b>	32.5	44.5	44.5	44.5	49.8	49.8	49.8	49.8	49.8	49.8	±0.5
<b>F</b>	54	61	61	61	75	75	75	75	75	75	±0.3
<b>G</b>	21	21	21	21	27	27	27	27	27	27	±0.2
<b>H</b>	9.3	10.8	10.8	10.8	12.3	12.3	12.3	12.3	12.3	12.3	±0.5
<b>I</b>	15.3	16.8	16.8	16.8	20.8	20.8	20.8	29.8	29.8	29.8	±0.5
<b>J</b>	21.8	25.25	25.25	25.25	19.9	19.9	19.9	11.4	11.4	11.4	±0.5
<b>K</b>	5.3	5.3	5.3	5.3	5.3	5.3	5.3	5.3	5.3	5.3	
<b>L</b>	6.3	6.3	6.3	6.3	6.3	6.3	6.3	6.3	6.3	6.3	
<b>M</b>	0.7	0.7	0.7	0.7	0.7	0.7	0.7	0.7	0.7	0.7	
<b>Connection style -06</b>											
<b>N</b>	6.3 x 0.8	6.3 x 0.8	6.3 x 0.8	6.3 x 0.8	6.3 x 0.8	6.3 x 0.8	6.3 x 0.8	6.3 x 0.8	6.3 x 0.8	6.3 x 0.8	
<b>Connection style -07</b>											
<b>O</b>	8.3	8.3	8.3	8.3	8.3	8.3	8.3	8.3	8.3		±0.5
<b>P</b>	21.8	14	14	14	14.9	14.9	14.9	14.9	14.9		±0.5
<b>AWG type wire</b>	AWG 20	AWG 20	AWG 20	AWG 18	AWG 18	AWG 18	AWG 16	AWG 16			
<b>Wire length</b>	140	140	140	140	140	140	140	140			+5
<b>Connection style -08</b>											
<b>N</b>									M4	M4	
<b>Recommended torque (Nm)</b>									1.2 - 1.3	1.2 - 1.3	

All dimensions in mm; 1 inch = 25.4 mm  
Tolerances according: ISO 2768-m/EN 22768-m



## Headquarters, global innovation and development

### Switzerland

#### Schaffner Group

Nordstrasse 11  
4542 Luterbach  
T +41 32 681 66 26  
F +41 32 681 66 30  
[info@schaffner.com](mailto:info@schaffner.com)  
<http://www.schaffner.com>



## Sales and application centers

### China

#### Schaffner EMC Ltd. Shanghai

T20-3 C, No 565 Chuangye Road,  
Pudong district  
201201 Shanghai  
T +86 21 3813 9500  
[cschina@schaffner.com](mailto:cschina@schaffner.com)  
<http://www.schaffner.com.cn>

### Finland

#### Schaffner Oy

Sauvonrinne 19 H  
08500 Lohja  
T +358 50 468 7284  
[finlandsales@schaffner.com](mailto:finlandsales@schaffner.com)

### France

#### Schaffner EMC S.A.S.

16-20 Rue Louis Rameau  
95875 Bezons  
T +33 1 34 34 30 60  
F +33 1 39 47 02 28  
[francesales@schaffner.com](mailto:francesales@schaffner.com)

### Germany

#### Schaffner Deutschland GmbH

Schoemperlenstrasse 12B  
76185 Karlsruhe  
T +49 721 56910  
F +49 721 569110  
[germanysales@schaffner.com](mailto:germanysales@schaffner.com)

### India

#### Schaffner India Pvt. Ltd

Unit 59, Level, Mfar Greenheart 7  
Manyata Tech Park, Hebbal Outer Ring Road  
560045 Bangalore  
T +91 80 6781 9805  
F +91 80 6781 9998  
[indiasales@schaffner.com](mailto:indiasales@schaffner.com)

### Italy

#### Schaffner EMC S.r.l.

Via Galileo Galilei 47  
20092 Cinisello Balsamo (MI)  
T +39 02 66 04 30 45 /47  
F +39 02 61 23 943  
[italysales@schaffner.com](mailto:italysales@schaffner.com)

### Japan

#### Schaffner EMC K.K.

1-32-12, Kamiyama, Setagaya-ku  
7F Mitsui-seimei Sangenjaya Bldg.  
154-0011 Tokyo  
T +81 3 5712 3650  
F +81 3 5712 3651  
[japansales@schaffner.com](mailto:japansales@schaffner.com)  
<http://www.schaffner.jp>

### Singapore

#### Schaffner EMC Pte Ltd.

#05-09, Kg Ubi Ind. Estate  
408705 Singapore  
T +65 6377 3283  
F +65 6377 3281  
[singaporesales@schaffner.com](mailto:singaporesales@schaffner.com)

### Spain

#### Schaffner EMC España

Calle Caléndula 93, Miniparc III, Edificio E  
El Soto de Moraleja, Alcobendas  
28109 Madrid  
T +34 917 912 900  
F +34 917 912 901  
[spainsales@schaffner.com](mailto:spainsales@schaffner.com)

### Sweden

#### Schaffner EMC AB

Tegeluddsvägen 76, 2tr  
115 28 Stockholm  
T +46 8 5050 2425  
[swedensales@schaffner.com](mailto:swedensales@schaffner.com)  
<http://www.schaffner.com>

### Switzerland

#### Schaffner EMV AG

Nordstrasse 11  
4542 Luterbach  
T +41 32 681 66 26  
[switzerlandsales@schaffner.com](mailto:switzerlandsales@schaffner.com)

### Taiwan R.O.C.

#### Schaffner EMV Ltd.

20 Floor-2, No 97, Section 1, XinTai 5th Road  
22175 XiZhi District New Taipei City 22175  
T +886 2 2697 5500  
F +886 2 2697 5533  
[taiwansales@schaffner.com](mailto:taiwansales@schaffner.com)  
<http://www.schaffner.tw>

### Thailand

#### Schaffner EMC Co. Ltd.

Northern Region Industrial Estate  
67 Moo 4 Tambon Ban Klang  
Amphur Muangng P.O. Box 14  
51000 Lamphun  
T +66 53 58 11 04  
F +66 53 58 10 19  
[thailandsales@schaffner.com](mailto:thailandsales@schaffner.com)

### United Kingdom

#### Schaffner Ltd.

5 Ashville Way, Molly Millars Lane  
Wokingham  
RG41 2PL Berkshire  
T +44 118 9770070  
F +44 118 9792969  
[uksales@schaffner.com](mailto:uksales@schaffner.com)

### USA

#### Schaffner EMC Inc.

52 Mayfield Avenue  
08837 Edison, New Jersey  
T +1 800 367 5566  
T +1 732 225 9533  
F +1 732 225 4789  
[usasales@schaffner.com](mailto:usasales@schaffner.com)  
<http://www.schaffnerusa.com>

#### Schaffner North America

6722 Thirlane Road  
24019 Roanoke, Virginia  
T +1 276 228 7943  
F +1 276 228 7953

#### Schaffner North America

823 Fairview Road  
24382 Wytheville, Virginia  
T +1 276 228 7943  
F +1 276 228 7258

To find your local partner within Schaffner's global network: [www.schaffner.com](http://www.schaffner.com)

© 2016 Schaffner Group

The content of this document has been carefully checked and understood. However, neither Schaffner nor its subsidiaries assume any liability whatsoever for any errors or inaccuracies of this document and the consequences thereof. Published specifications are subject to change without notice. Product suitability for any area of application must ultimately be determined by the customer. In all cases, products must never be operated outside their published specifications. Schaffner does not guarantee the availability of all published products. This disclaimer shall be governed by substantive Swiss law and resulting disputes shall be settled by the courts at the place of business of Schaffner Holding AG. Latest publications and a complete disclaimer can be downloaded from the Schaffner website. All trademarks recognized.



Компания «ЭлектроПласт» предлагает заключение долгосрочных отношений при поставках импортных электронных компонентов на взаимовыгодных условиях!

Наши преимущества:

- Оперативные поставки широкого спектра электронных компонентов отечественного и импортного производства напрямую от производителей и с крупнейших мировых складов;
- Поставка более 17-ти миллионов наименований электронных компонентов;
- Поставка сложных, дефицитных, либо снятых с производства позиций;
- Оперативные сроки поставки под заказ (от 5 рабочих дней);
- Экспресс доставка в любую точку России;
- Техническая поддержка проекта, помощь в подборе аналогов, поставка прототипов;
- Система менеджмента качества сертифицирована по Международному стандарту ISO 9001;
- Лицензия ФСБ на осуществление работ с использованием сведений, составляющих государственную тайну;
- Поставка специализированных компонентов (Xilinx, Altera, Analog Devices, Intersil, Interpoint, Microsemi, Aeroflex, Peregrine, Syfer, Eurofarad, Texas Instrument, Miteq, Cobham, E2V, MA-COM, Hittite, Mini-Circuits, General Dynamics и др.);

Помимо этого, одним из направлений компании «ЭлектроПласт» является направление «Источники питания». Мы предлагаем Вам помощь Конструкторского отдела:

- Подбор оптимального решения, техническое обоснование при выборе компонента;
- Подбор аналогов;
- Консультации по применению компонента;
- Поставка образцов и прототипов;
- Техническая поддержка проекта;
- Защита от снятия компонента с производства.



#### Как с нами связаться

**Телефон:** 8 (812) 309 58 32 (многоканальный)

**Факс:** 8 (812) 320-02-42

**Электронная почта:** [org@eplast1.ru](mailto:org@eplast1.ru)

**Адрес:** 198099, г. Санкт-Петербург, ул. Калинина, дом 2, корпус 4, литера А.