

# 6-Channel, Digital Ground-Level Translator

## General Description

The MAX14842 translates digital signals between two domains that have different ground references of up to 72V. The device features six communication channels, two bidirectional and four unidirectional. Two of the four unidirectional channels go in each direction. The device is powered by two supply voltages that independently define the logic levels of each ground domain.

The MAX14842 supports guaranteed data rates up to 30Mbps on the four unidirectional channels and up to 2Mbps on the two bidirectional channels. The bidirectional channels have open-drain outputs, making them suitable for I<sup>2</sup>C signals. I<sup>2</sup>C clock stretching and hot swapping is supported on the bidirectional channels.

Undervoltage lockout ensures that the output pins have a defined behavior during power-up, power-down, and during supply transients. For proper operation, ensure that  $0V \leq (V_{GNDB} - V_{GNDA}) \leq 72V$ . Note that GNDB must be greater than or equal to GNDA.

The MAX14842 is available in a 16-pin TQFN package and is specified over the -40°C to +125°C automotive temperature range.

## Ordering Information

PART	TEMP RANGE	PIN-PACKAGE
MAX14842ATE+	-40°C to +125°C	16 TQFN-EP**

\*\*EP = Exposed pad.

+Denotes a lead(Pb)-free/RoHS-compliant package.

## Features

- ◆ Supports Ground Differences Up to 72V
- ◆ Four Unidirectional Channels: Two In/Two Out
- ◆ Two Bidirectional Channels
- ◆ I<sup>2</sup>C Compatible
- ◆ Supports I<sup>2</sup>C Clock Stretching
- ◆ 30Mbps Unidirectional Data Rates
- ◆ 2Mbps Bidirectional Data Rates
- ◆ +3.3V to +5V Level Translation
- ◆ Undervoltage Lockout
- ◆ 4mm x 4mm, 16-Pin TQFN Package
- ◆ -40°C to +125°C Automotive Temperature Range

## Applications

Telecommunication Systems  
 Battery Management  
 I<sup>2</sup>C, SMBus™, SPI™, and MICROWIRE™ Signals  
 Medical Systems  
 Power-Over-Ethernet

SMBus is a trademark of Intel Corp.

SPI is a trademark of Motorola, Inc.

MICROWIRE is a trademark of National Semiconductor Corp.

## Typical Operating Circuit

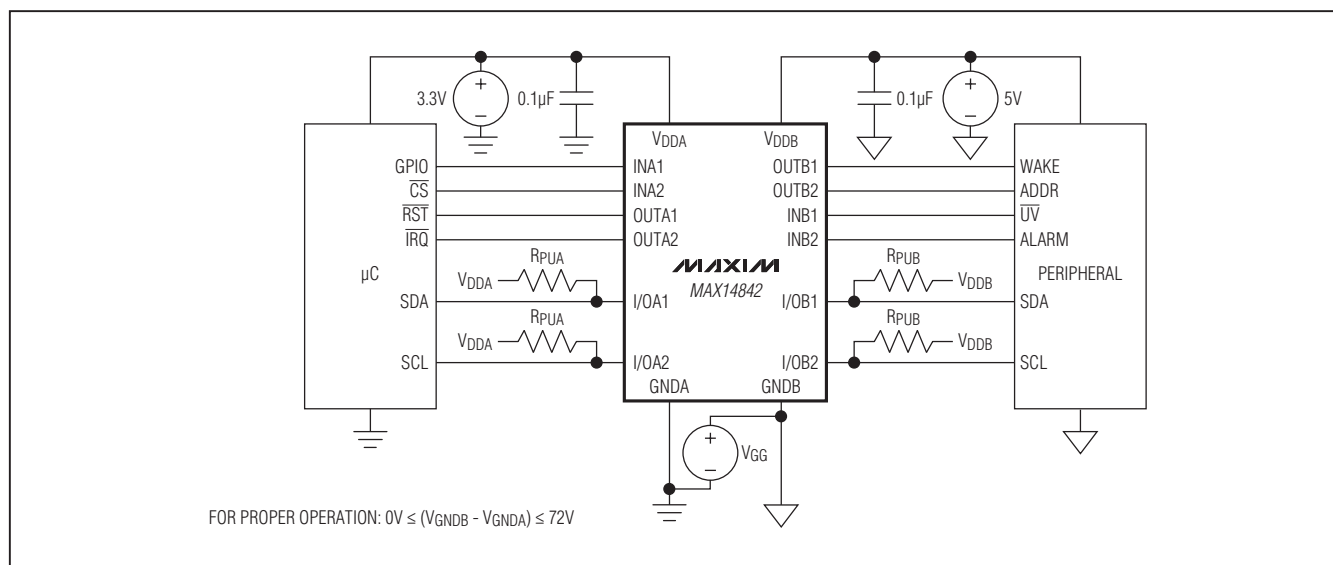

# 6-Channel, Digital Ground-Level Translator

## ABSOLUTE MAXIMUM RATINGS

V <sub>DDA</sub> to GNDA	-0.3V to +6V	Short-Circuit Duration (OUTA1, OUTA2 to GNDA; OUTB1, OUTB2 to GNDB)	Continuous
V <sub>DDB</sub> to GNDB	-0.3V to +6V	Continuous Power Dissipation (T <sub>A</sub> = +70°C)	TQFN (derate 25mW/°C above +70°C)
GNDB to GNDA	-0.3V to +80V	Operating Temperature Range	-40°C to +125°C
INA1, INA2 to GNDA	-0.3V to (V <sub>DDA</sub> + 0.3V)	Junction Temperature	+150°C
INB1, INB2 to GNDB	-0.3V to (V <sub>DDB</sub> + 0.3V)	Storage Temperature Range	-65°C to +150°C
OUTA1, OUTA2 to GNDA	-0.3V to (V <sub>DDA</sub> + 0.3V)	Lead Temperature (soldering, 10s)	+300°C
OUTB1, OUTB2 to GNDB	-0.3V to (V <sub>DDB</sub> + 0.3V)	Soldering Temperature (reflow)	+260°C
I/OA1, I/OA2 to GNDA	-0.3V to +6V		
I/OB1, I/OB2 to GNDB	-0.3V to +6V		
Common-Mode Transients (i.e., Transients Between GNDA and GNDB)	10V/μs		

## PACKAGE THERMAL CHARACTERISTICS (Note 1)

TQFN

Junction-to-Ambient Thermal Characteristics (θ <sub>JA</sub> )	40°C/W
Junction-to-Case Thermal Characteristics (θ <sub>JC</sub> )	6°C/W

**Note 1:** Package thermal resistances were obtained using the method described in JEDEC specification JESD51-7, using a four-layer board. For detailed information on package thermal considerations, refer to [www.maxim-ic.com/thermal-tutorial](http://www.maxim-ic.com/thermal-tutorial).

Stresses beyond those listed under "Absolute Maximum Ratings" may cause permanent damage to the device. These are stress ratings only, and functional operation of the device at these or any other conditions beyond those indicated in the operational sections of the specifications is not implied. Exposure to absolute maximum rating conditions for extended periods may affect device reliability.

## ELECTRICAL CHARACTERISTICS

(V<sub>DDA</sub> - V<sub>GNDA</sub> = +3.0V to +5.5V, V<sub>DDB</sub> - V<sub>GNDB</sub> = +3.0V to +5.5V, V<sub>GNDB</sub> - V<sub>GNDA</sub> = 0 to +72V, T<sub>A</sub> = -40°C to +125°C, unless otherwise noted. Typical values are at V<sub>DDA</sub> - V<sub>GNDA</sub> = +3.3V, V<sub>DDB</sub> - V<sub>GNDB</sub> = +3.3V, V<sub>GNDB</sub> - V<sub>GNDA</sub> = +50V, T<sub>A</sub> = +25°C.) (Note 2)

PARAMETER	SYMBOL	CONDITIONS	MIN	TYP	MAX	UNIT
<b>DC CHARACTERISTICS</b>						
Supply Voltage	V <sub>DDA</sub>	Relative to GNDA	3.0		5.5	V
	V <sub>DDB</sub>	Relative to GNDB	3.0		5.5	
Supply Current	I <sub>DDA</sub> I <sub>DDB</sub>	V <sub>DDA</sub> - V <sub>GNDA</sub> = +5.5V; V <sub>DDB</sub> - V <sub>GNDB</sub> = +5.5V; V <sub>GNDB</sub> - V <sub>GNDA</sub> = +70V; all inputs at V <sub>GNDA</sub> , V <sub>GNDB</sub> , or +5.5V; no load			7.5	mA
Voltage Between GNDB and GNDA	V <sub>GG</sub>	V <sub>GNDB</sub> - V <sub>GNDA</sub>	0		72	V
Side B Leakage Current	I <sub>L</sub>				1	mA
Undervoltage-Lockout Threshold	V <sub>UVLO</sub>	V <sub>DDA</sub> - V <sub>GNDA</sub> , V <sub>DDB</sub> - V <sub>GNDB</sub>		2		V
Undervoltage-Lockout Hysteresis	V <sub>UVLOHYS</sub>	V <sub>DDA</sub> - V <sub>GNDA</sub> , V <sub>DDB</sub> - V <sub>GNDB</sub>		0.1		V
<b>LOGIC INPUTS AND OUTPUTS</b>						
Input Logic Threshold Voltage	V <sub>IT</sub>	I/OA1, I/OA2, relative to GNDA	0.5		0.7	V
Input Logic-High Voltage	V <sub>IH</sub>	INA1, INA2, relative to GNDA	0.7 x V <sub>DDA</sub>		V	
		INB1, INB2, relative to GNDB	0.7 x V <sub>DDB</sub>			
		I/OA1, I/OA2, relative to GNDA	0.7			
		I/OB1, I/OB2, relative to GNDB	0.7 x V <sub>DDB</sub>			

# 6-Channel, Digital Ground-Level Translator

MAX14842

## ELECTRICAL CHARACTERISTICS (continued)

(V<sub>DDA</sub> - V<sub>GNDA</sub> = +3.0V to +5.5V, V<sub>DDDB</sub> - V<sub>GNDB</sub> = +3.0V to +5.5V, V<sub>GNDB</sub> - V<sub>GNDA</sub> = 0 to +72V, T<sub>A</sub> = -40°C to +125°C, unless otherwise noted. Typical values are at V<sub>DDA</sub> - V<sub>GNDA</sub> = +3.3V, V<sub>DDDB</sub> - V<sub>GNDB</sub> = +3.3V, V<sub>GNDB</sub> - V<sub>GNDA</sub> = +50V, T<sub>A</sub> = +25°C.) (Note 2)

PARAMETER	SYMBOL	CONDITIONS	MIN	TYP	MAX	UNIT
Input Logic-Low Voltage	V <sub>IL</sub>	INA1, INA2, relative to GNDA			0.8	V
		INB1, INB2, relative to GNDB			0.8	
		I/OA1, I/OA2, relative to GNDA			0.5	
		I/OB1, I/OB2, relative to GNDB			0.3 x V <sub>DDDB</sub>	
Output Logic-High Voltage	V <sub>OH</sub>	OUTA1, OUTA2, relative to GNDA, source current = 4mA	V <sub>DDA</sub> - 0.4V			V
		OUTB1, OUTB2, relative to GNDB, source current = 4mA	V <sub>DDDB</sub> - 0.4V			
Output Logic-Low Voltage	V <sub>OL</sub>	OUTA1, OUTA2, relative to GNDA, sink current = 4mA			0.8	V
		OUTB1, OUTB2, relative to GNDB, sink current = 4mA			0.8	
		I/OA1, I/OA2, relative to GNDA, sink current = 10mA	0.6		0.9	
		I/OA1, I/OA2, relative to GNDA, sink current = 0.5mA	0.6		0.85	
		I/OB1, I/OB2, relative to GNDB, sink current = 30mA			0.4	
Input/Output Logic-Low Threshold Difference	ΔV <sub>TOL</sub>	I/OA1, I/OA2 (Note 3)	50			mV
Input Leakage Current	I <sub>L</sub>	V <sub>INA1</sub> , V <sub>INA2</sub> , V <sub>DDA</sub> = +3.6V, V <sub>INB1</sub> , V <sub>INB2</sub> , V <sub>DDDB</sub> = +3.6V	-2		+2	μA
		V <sub>I/OA1</sub> , V <sub>I/OA2</sub> , V <sub>DDA</sub> = +3.6V, V <sub>I/OB1</sub> , V <sub>I/OB2</sub> , V <sub>DDDB</sub> = +3.6V	-2		+2	
Input Capacitance	C <sub>IN</sub>	INA1, INA2, INB1, INB2, f = 1MHz (Note 4)		4		pF
<b>DYNAMIC SWITCHING CHARACTERISTICS</b>						
Maximum Data Rate	DR <sub>MAX</sub>	INA1 to OUTB1, INA2 to OUTB2, INB1 to OUTA1, INB2 to OUTA2	30			Mbps
		I/OA1 to I/OB1, I/OA2 to I/OB2, I/OB1 to I/OA1, I/OB2 to I/OA2	2			
Minimum Pulse Width	PW <sub>MIN</sub>	INA1 to OUTB1, INA2 to OUTB2, INB1 to OUTA1, INB2 to OUTA2	30			ns
Propagation Delay	t <sub>DPLH</sub> t <sub>DPHL</sub>	INA1 to OUTB1, INA2 to OUTB2, INB1 to OUTA1, INB2 to OUTA2, V <sub>DDA</sub> = V <sub>DDDB</sub> = +3.0V, R <sub>L</sub> = 1MΩ, C <sub>L</sub> = 15pF, Figure 1		20	30	ns
		I/OA1 to I/OB1, I/OA2 to I/OB2, V <sub>DDA</sub> = V <sub>DDDB</sub> = +3.0V, R <sub>1</sub> = 1.6kΩ, R <sub>2</sub> = 180Ω, C <sub>L1</sub> = C <sub>L2</sub> = 15pF, Figure 2		30	100	
	I/OB1 to I/OA1, I/OB2 to I/OA2, V <sub>DDA</sub> = V <sub>DDDB</sub> = +3.0V, R <sub>1</sub> = 1kΩ, R <sub>2</sub> = 120Ω, C <sub>L1</sub> = C <sub>L2</sub> = 15pF, Figure 2		60	100		

## 6-Channel, Digital Ground-Level Translator

### ELECTRICAL CHARACTERISTICS (continued)

( $V_{DDA} - V_{GNDA} = +3.0V$  to  $+5.5V$ ,  $V_{DDB} - V_{GNDB} = +3.0V$  to  $+5.5V$ ,  $V_{GNDB} - V_{GNDA} = 0$  to  $+72V$ ,  $T_A = -40^\circ C$  to  $+125^\circ C$ , unless otherwise noted. Typical values are at  $V_{DDA} - V_{GNDA} = +3.3V$ ,  $V_{DDB} - V_{GNDB} = +3.3V$ ,  $V_{GNDB} - V_{GNDA} = +50V$ ,  $T_A = +25^\circ C$ .) (Note 2)

PARAMETER	SYMBOL	CONDITIONS	MIN	TYP	MAX	UNIT
Propagation Delay Skew $ t_{DPLH} - t_{DPLH} $	$t_{DSKEW}$	I/OA1 to I/OB1, I/OA2 to I/OB2, $V_{DDA} = V_{DDB} = +3.0V$ , $R_1 = 1.6k\Omega$ , $R_2 = 180\Omega$ , $C_{L1} = C_{L2} = 15pF$ , Figure 2		3	6	ns
		I/OB1 to I/OA1, I/OB2 to I/OA2, $V_{DDA} = V_{DDB} = +3.0V$ , $R_1 = 1k\Omega$ , $R_2 = 120\Omega$ , $C_{L1} = C_{L2} = 15pF$ , Figure 2		30	100	
Channel-to-Channel Skew	$t_{DSKEWCC}$	OUTB1 to OUTB2 output skew, Figure 1		3	6	ns
		OUTA1 to OUTA2 output skew, Figure 1		3	6	
		I/OB1 to I/OB2 output low skew, Figure 2		3	10	
		I/OA1 to I/OA2 output low skew, Figure 2		3	10	
Rise Time	$t_R$	OUTB1, OUTB2, OUTA1, OUTA2, 10% to 90%, Figure 1			5	ns
Fall Time	$t_F$	OUTB1, OUTB2, OUTA1, OUTA2, 90% to 10%, Figure 1			5	ns
		I/OA1, I/OA2, 90% to 10%, $V_{DDA} = V_{DDB} =$ $+3.0V$ , $R_1 = 1.6k\Omega$ , $R_2 = 180\Omega$ , $C_{L1} = C_{L2}$ $= 15pF$ , Figure 2		30	60	
		I/OB1, I/OB2, 90% to 10%, $V_{DDA} = V_{DDB} =$ $+3.0V$ , $R_1 = 1k\Omega$ , $R_2 = 120\Omega$ , $C_{L1} = C_{L2} =$ $15pF$ , Figure 2		3	6	

**Note 2:** All units are production tested at  $T_A = +25^\circ C$ . Specifications over temperature are guaranteed by design. All voltages of side A are referenced to GNDA; all voltages of side B are referenced to GNDB, unless otherwise noted.

**Note 3:**  $\Delta V_{TOL} = V_{OL} - V_{IL}$ . This is the minimum difference between the output logic-low voltage and the input logic threshold for the same I/O pin. This ensures that the I/O channels are not latched low when any of the I/O inputs are driven low (see the *Bidirectional Channels* section).

**Note 4:** Guaranteed by design; not production tested.

# 6-Channel, Digital Ground-Level Translator

## Test Circuits/Timing Diagrams

MAX14842

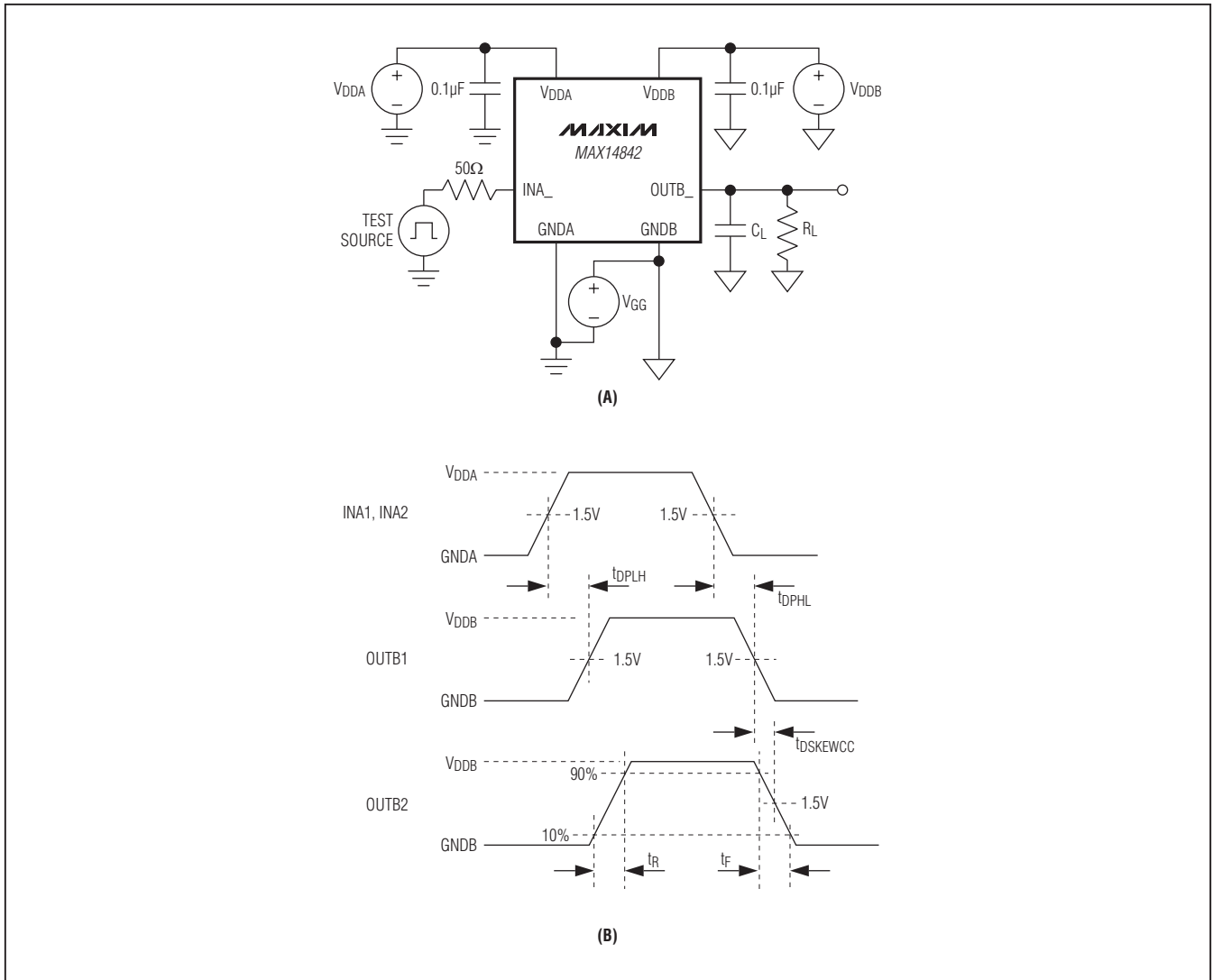

Figure 1. Test Circuit (A) and Timing Diagram (B) for Unidirectional Testing

# 6-Channel, Digital Ground-Level Translator

## Test Circuits/Timing Diagrams (continued)

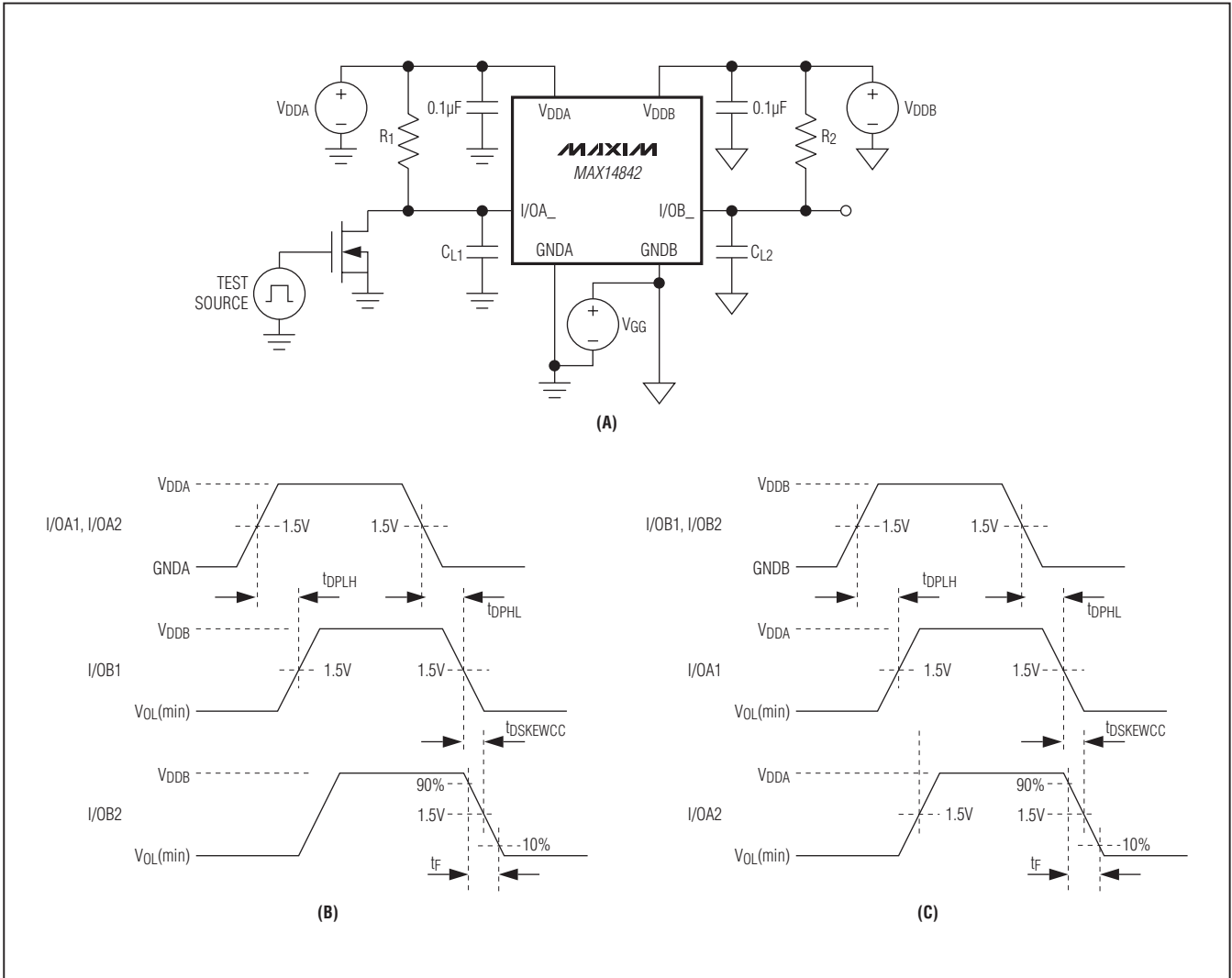

Figure 2. Test Circuit (A) and Timing Diagrams (B) and (C) for Bidirectional Testing

# 6-Channel, Digital Ground-Level Translator

MAX14842

## Typical Operating Characteristics

( $V_{DDA} - V_{GNDA} = +3.3V$ ,  $V_{DDB} - V_{GNDB} = +3.3V$ ,  $V_{GNDB} - V_{GNDA} = +50V$ ,  $R_{PUA} = R_{PUB} = 2k\Omega$ ,  $C_L = 15pF$ , see the *Typical Operating Circuit*,  $T_A = +25^\circ C$ , unless otherwise noted.)

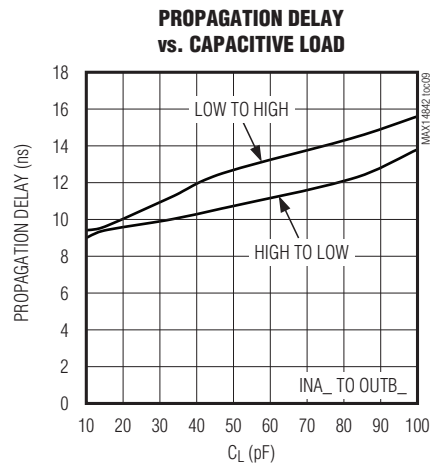
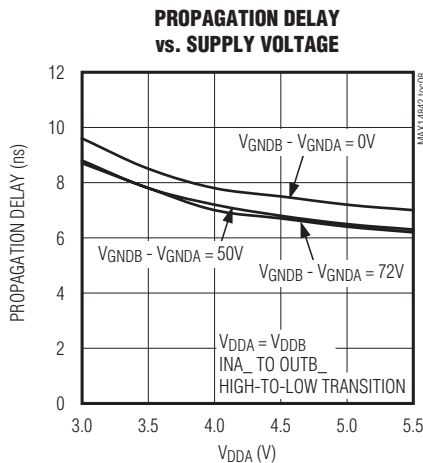
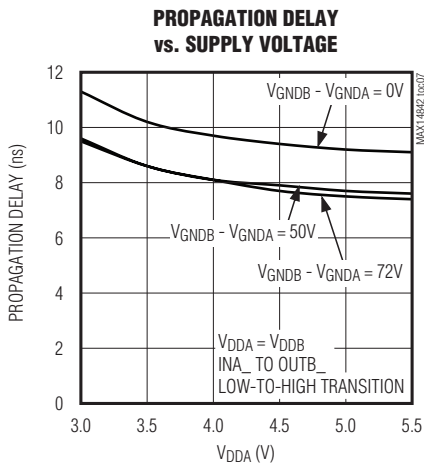
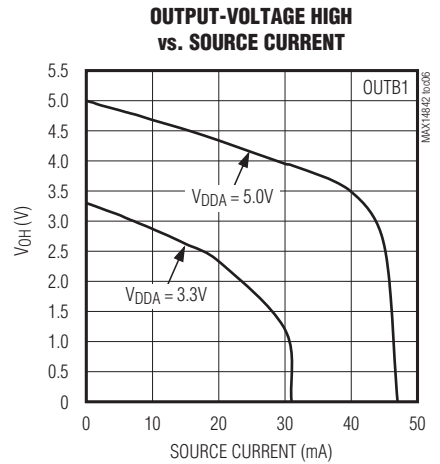
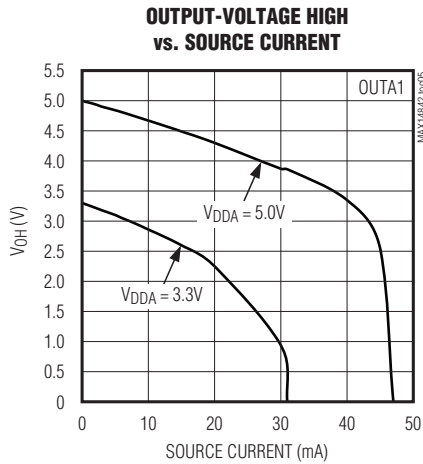
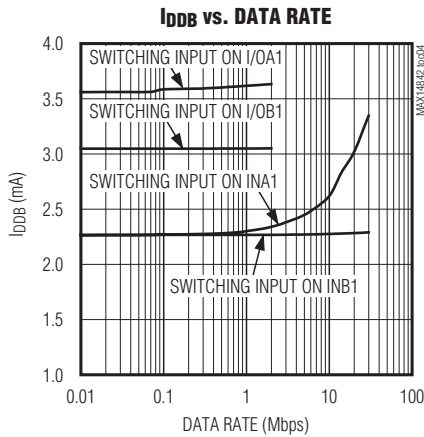
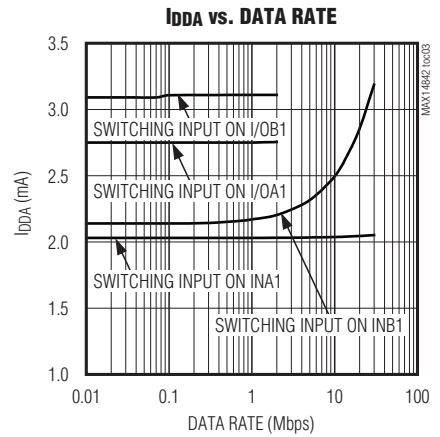
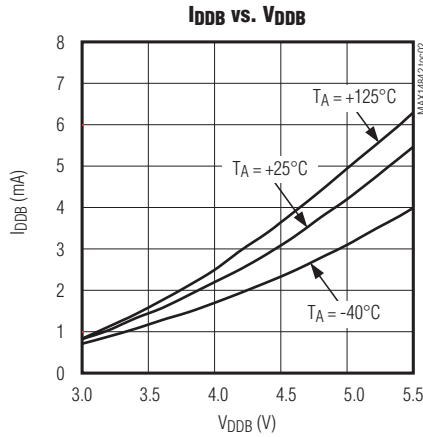
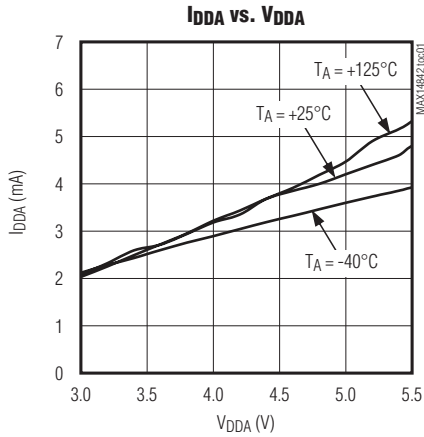

# 6-Channel, Digital Ground-Level Translator

## Typical Operating Characteristics (continued)

( $V_{DDA} - V_{GNDA} = +3.3V$ ,  $V_{DDB} - V_{GNDB} = +3.3V$ ,  $V_{GNDB} - V_{GNDA} = +50V$ ,  $R_{PUA} = R_{PUB} = 2k\Omega$ ,  $C_L = 15pF$ , see the *Typical Operating Circuit*,  $T_A = +25^\circ C$ , unless otherwise noted.)

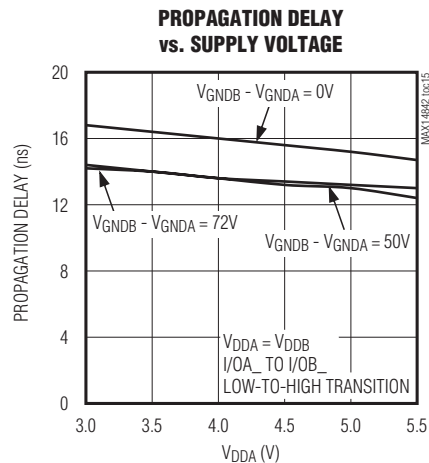
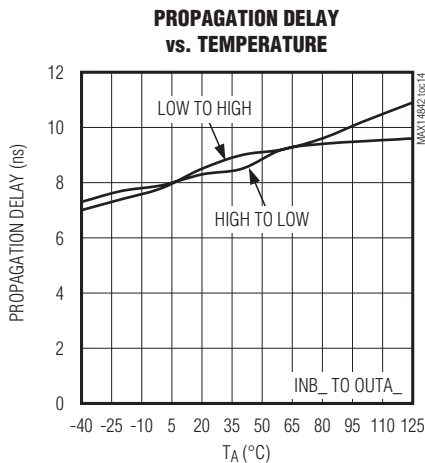
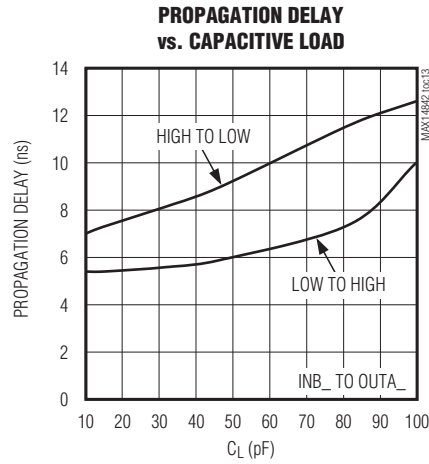
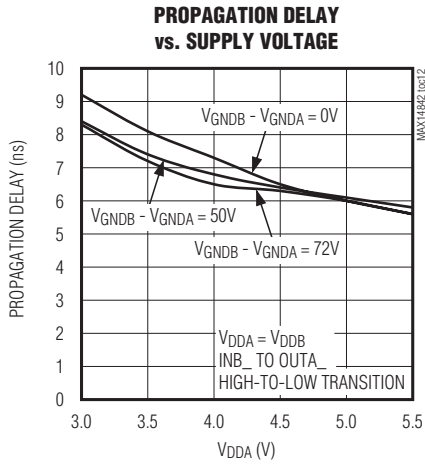
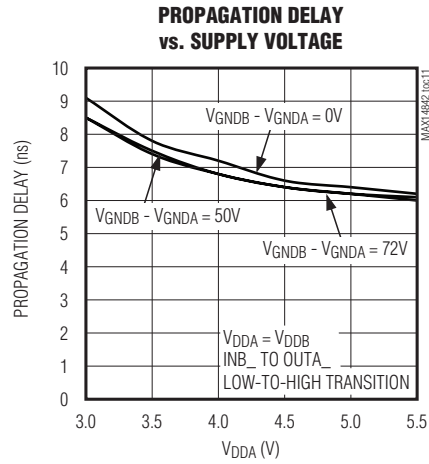
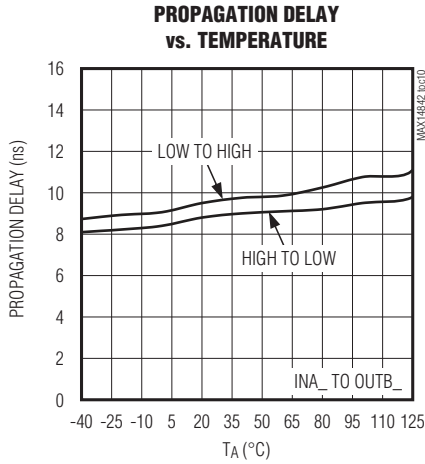



# 6-Channel, Digital Ground-Level Translator

MAX14842

## Typical Operating Characteristics (continued)

( $V_{DDA} - V_{GNDA} = +3.3V$ ,  $V_{DDB} - V_{GNDB} = +3.3V$ ,  $V_{GNDB} - V_{GNDA} = +50V$ ,  $R_{PUA} = R_{PUB} = 2k\Omega$ ,  $C_L = 15pF$ , see the *Typical Operating Circuit*,  $T_A = +25^\circ C$ , unless otherwise noted.)

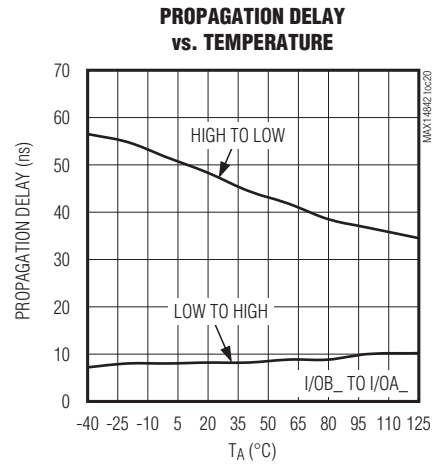
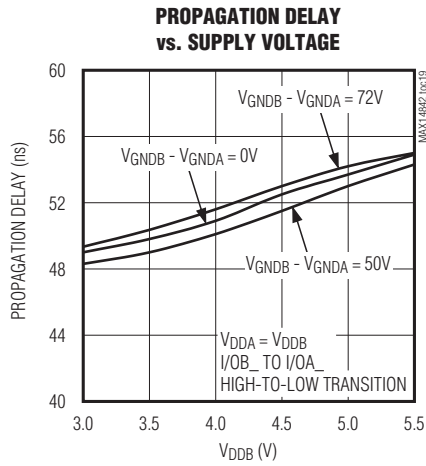
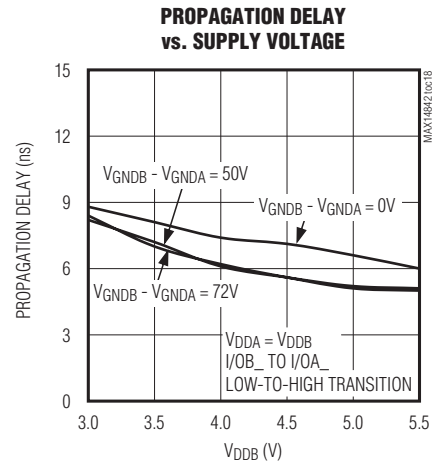
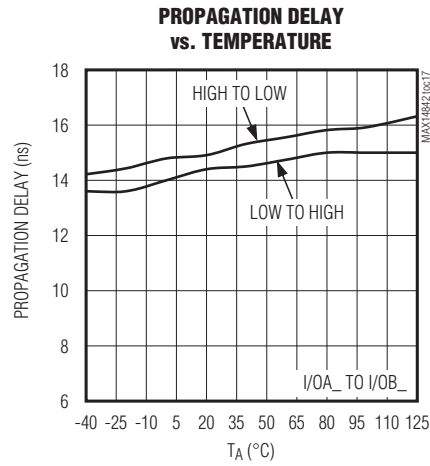
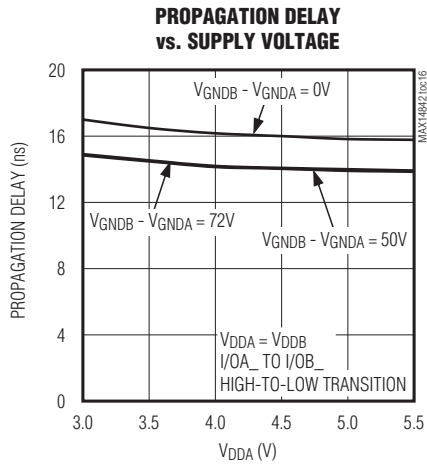

# 6-Channel, Digital Ground-Level Translator

## Pin Configuration

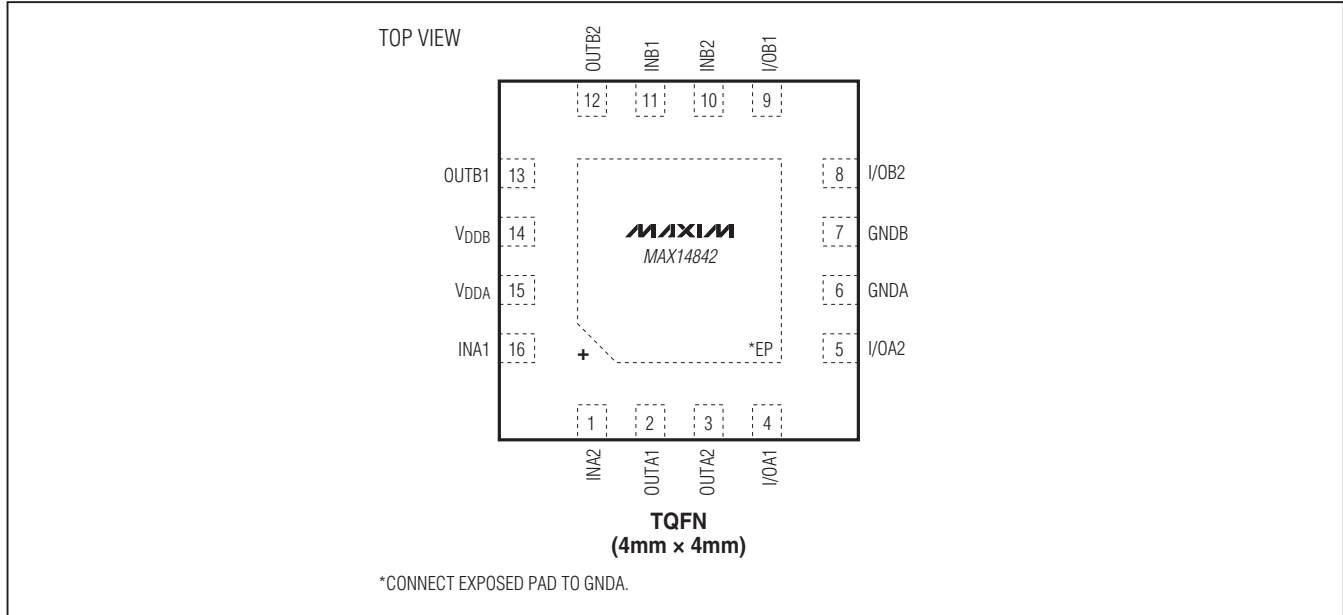

## Pin Description

PIN	NAME	FUNCTION	VOLTAGE RELATIVE TO
1	INA2	Logic Input 2 on Side A. INA2 is translated to OUTB2.	GNDA
2	OUTA1	Logic Output 1 on Side A. OUTA1 is a push-pull output.	GNDA
3	OUTA2	Logic Output 2 on Side A. OUTA2 is a push-pull output.	GNDA
4	I/OA1	Bidirectional Input/Output 1 on Side A. I/OA1 is translated to/from I/OB1 and is an open-drain output.	GNDA
5	I/OA2	Bidirectional Input/Output 2 on Side A. I/OA2 is translated to/from I/OB2 and is an open-drain output.	GNDA
6	GNDA	Ground Reference for Side A. $V_{GNDA}$ must be $\leq V_{GNDB}$ .	—
7	GNDB	Ground Reference for Side B. $V_{GNDB}$ must be $\geq V_{GNDA}$ .	—
8	I/OB2	Bidirectional Input/Output 2 on Side B. I/OB2 is translated to/from I/OA2 and is an open-drain output.	GNDB
9	I/OB1	Bidirectional Input/Output 1 on Side B. I/OB1 is translated to/from I/OA1 and is an open-drain output.	GNDB
10	INB2	Logic Input 2 on Side B. INB2 is translated to OUTA2.	GNDB
11	INB1	Logic Input 1 on Side B. INB1 is translated to OUTA1.	GNDB
12	OUTB2	Logic Output 2 on Side B. OUTB2 is a push-pull output.	GNDB
13	OUTB1	Logic Output 1 on Side B. OUTB1 is a push-pull output.	GNDB
14	VDDB	Supply Voltage of Logic Side B. Bypass $V_{DDB}$ with a 0.1 $\mu$ F ceramic capacitor to GNDB.	GNDB
15	VDDA	Supply Voltage of Logic Side A. Bypass $V_{DDA}$ with a 0.1 $\mu$ F ceramic capacitor to GNDA.	GNDA
16	INA1	Logic Input 1 on Side A. INA1 is translated to OUTB1.	GNDA
—	EP	Exposed Pad. Connect EP to GNDA.	—

# 6-Channel, Digital Ground-Level Translator

## Functional Diagram

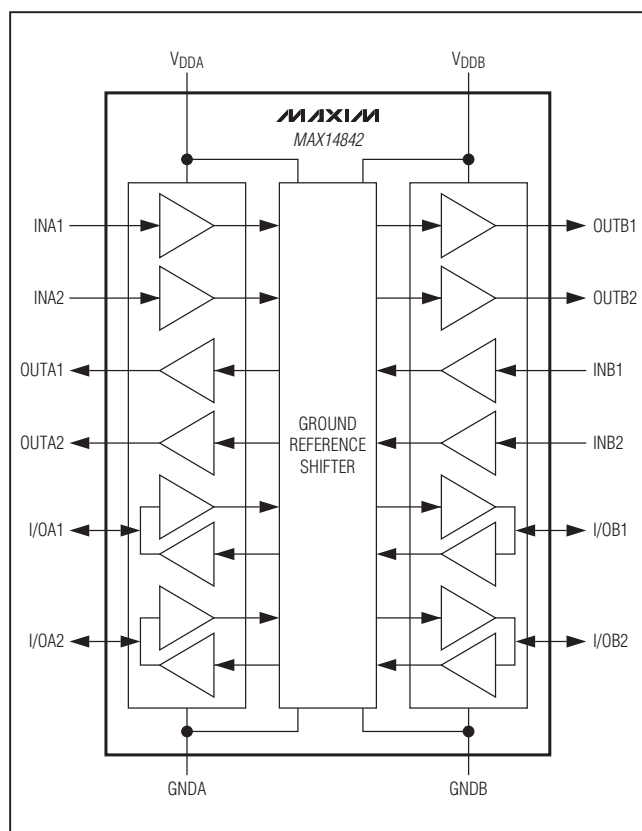

## Detailed Description

The MAX14842 provides both ground-level translation and logic-level shifting needed in systems where there is a difference in ground references of up to 72V. The device is powered by two supply voltages, VDDA and VDDB, which independently set the logic levels on either side of the device. VDDA and VDDB are separately referenced to GND A and GND B, respectively. The MAX14842 supports data rates of up to 30Mbps on each of the four unidirectional channels and 2Mbps on the two bidirectional channels.

### Ground Translation/Level Shifting

For proper operation, ensure that  $0V \leq (V_{GND B} - V_{GND A}) \leq 72V$ . Note that GND B must be greater than or equal to GND A.

Also ensure that  $3.0V \leq (V_{DDA} - V_{GND A}) \leq 5.5V$  and  $3.0V \leq (V_{DDB} - V_{GND B}) \leq 5.5V$ . ( $V_{DDA} - V_{GND A}$ ) can be

greater than or less than  $(V_{DDB} - V_{GND B})$ , as long as each is within the normal operating range.

### Unidirectional Channels

The device features four unidirectional channels that can each operate independently with a guaranteed data rate of up to 30Mbps. The output driver of each unidirectional channel is push-pull, eliminating the need for pullup resistors. The drivers are also able to drive both TTL and CMOS logic inputs.

### Bidirectional Channels

The device features two bidirectional translation channels that have open-drain outputs. The bidirectional channels do not require a direction input. A logic-low on one side causes the corresponding pin on the other side to be pulled low while avoiding data latching within the translator. To prevent latching of the bidirectional channels, the input logic-low threshold ( $V_{IT}$ ) of I/OA1 and I/OA2 is at least 50mV lower than the output logic-low voltages ( $V_{OL}$ ) of I/OA1 and I/OA2. This prevents an output logic-low on side A from being accepted as an input low and subsequently transmitted to side B and vice versa.

The I/OA1, I/OA2, I/OB1, and I/OB2 pins have open-drain outputs, requiring pullup resistors to their respective supplies for logic-high outputs. The output low voltages are guaranteed for sink currents of up to 30mA for side B and 10mA for side A (see the *Electrical Characteristics* table).

The bidirectional channels of the device support I<sup>2</sup>C clock stretching.

### Separate Ground References

The device is designed to translate logic signals to and from domains with isolated and offset ground references.

### Startup and Undervoltage Lockout

The VDDA and VDDB supplies are both internally monitored for undervoltage conditions. Undervoltage events can occur during power-up, power-down, or during normal operation due to a slump in the supplies. When an undervoltage event occurs on either of the supplies, all outputs on both sides are automatically controlled, regardless of the status of the inputs. The bidirectional outputs become high impedance and are pulled high by the external pullup resistor on the open-drain output. The unidirectional outputs are pulled high internally to the voltage of the VDDA or VDDB supply during undervoltage conditions.

## 6-Channel, Digital Ground-Level Translator

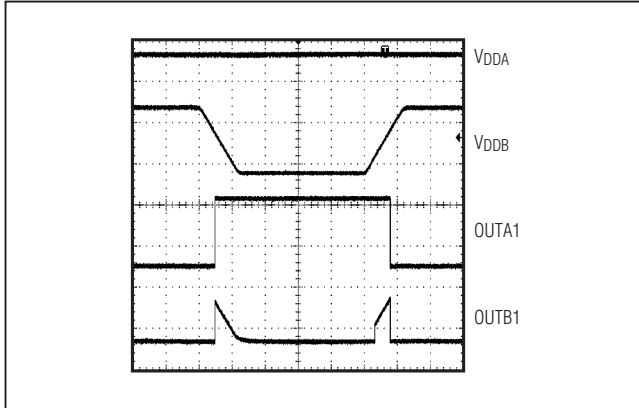

Figure 3. Undervoltage Lockout Behavior

Figure 3 shows the behavior of the outputs during power up and power down.

### Applications Information

#### AC Components on VGG

When the ground difference voltage,  $V_{GG}$ , has a time varying (AC) component, limit the amplitude to ensure that the MAX14842 operates as specified. The maximum allowable amplitude of an AC signal on  $V_{GG}$  is a function of frequency.

#### Power-Supply Sequencing

The MAX14842 does not require power-supply sequencing. The logic levels are set independently on either side by  $V_{DDA}$  and  $V_{DDB}$ . Each supply can be present over the entire specified range regardless of the level or presence of the other.

#### Power-Supply Decoupling

To reduce ripple and the chance of introducing data errors, bypass  $V_{DDA}$  and  $V_{DDB}$  with  $0.1\mu\text{F}$  ceramic capacitors to  $G_{NDA}$  and  $G_{NDB}$ , respectively. Place the bypass capacitors as close to the power-supply input pins as possible.

#### Unidirectional and Bidirectional Level Translator

The MAX14842 operates both as a unidirectional device and bidirectional device simultaneously. Each unidirectional channel can only be used in the direction shown in the *Functional Diagram*. The bidirectional channels function without requiring a direction input.

### Chip Information

PROCESS: BiCMOS

### Package Information

For the latest package outline information and land patterns (footprints), go to [www.maxim-ic.com/packages](http://www.maxim-ic.com/packages). Note that a "+", "#", or "-" in the package code indicates RoHS status only. Package drawings may show a different suffix character, but the drawing pertains to the package regardless of RoHS status.

PACKAGE TYPE	PACKAGE CODE	OUTLINE NO.	LAND PATTERN NO.
16 TQFN-EP	T1644+4	<a href="#">21-0139</a>	<a href="#">90-0070</a>

# 6-Channel, Digital Ground-Level Translator

## Revision History

REVISION NUMBER	REVISION DATE	DESCRIPTION	PAGES CHANGED
0	12/10	Initial release	—
1	3/11	Deleted the MAX14842ETE+ from the <i>Ordering Information</i> , removed the future status from the MAX14842ATE+ in the <i>Ordering Information</i> , added the automotive temperature range to the <i>Features</i> , <i>Absolute Maximum Ratings</i> , and the <i>Electrical Characteristics</i> sections	1-4

MAX14842

Maxim cannot assume responsibility for use of any circuitry other than circuitry entirely embodied in a Maxim product. No circuit patent licenses are implied. Maxim reserves the right to change the circuitry and specifications without notice at any time.

Maxim Integrated Products, 120 San Gabriel Drive, Sunnyvale, CA 94086 408-737-7600 \_\_\_\_\_ 13



Компания «ЭлектроПласт» предлагает заключение долгосрочных отношений при поставках импортных электронных компонентов на взаимовыгодных условиях!

Наши преимущества:

- Оперативные поставки широкого спектра электронных компонентов отечественного и импортного производства напрямую от производителей и с крупнейших мировых складов;
- Поставка более 17-ти миллионов наименований электронных компонентов;
- Поставка сложных, дефицитных, либо снятых с производства позиций;
- Оперативные сроки поставки под заказ (от 5 рабочих дней);
- Экспресс доставка в любую точку России;
- Техническая поддержка проекта, помощь в подборе аналогов, поставка прототипов;
- Система менеджмента качества сертифицирована по Международному стандарту ISO 9001;
- Лицензия ФСБ на осуществление работ с использованием сведений, составляющих государственную тайну;
- Поставка специализированных компонентов (Xilinx, Altera, Analog Devices, Intersil, Interpoint, Microsemi, Aeroflex, Peregrine, Syfer, Eurofarad, Texas Instrument, Miteq, Cobham, E2V, MA-COM, Hittite, Mini-Circuits, General Dynamics и др.);

Помимо этого, одним из направлений компании «ЭлектроПласт» является направление «Источники питания». Мы предлагаем Вам помощь Конструкторского отдела:

- Подбор оптимального решения, техническое обоснование при выборе компонента;
- Подбор аналогов;
- Консультации по применению компонента;
- Поставка образцов и прототипов;
- Техническая поддержка проекта;
- Защита от снятия компонента с производства.



#### Как с нами связаться

**Телефон:** 8 (812) 309 58 32 (многоканальный)

**Факс:** 8 (812) 320-02-42

**Электронная почта:** [org@eplast1.ru](mailto:org@eplast1.ru)

**Адрес:** 198099, г. Санкт-Петербург, ул. Калинина, дом 2, корпус 4, литера А.